



ТЕЛЕФОНЫ

0 (800) 800 130
(050) 462 0 130
(063) 462 0 130
(067) 462 0 130

130
COM.UA

Интернет-магазин
автотоваров



SKYPE
km-130

АВТОМАГНИТОЛЫ — Магнитолы • Медиа-ресиверы и станции • Штатные магнитолы • CD/DVD чейнджеры • FM-модуляторы/USB адаптеры • Flash память • Переходные рамки и разъемы • Антенны • Аксессуары | **АВТОЗВУК** — Акустика • Усилители • Сабвуферы • Процессоры • Кроссоверы • Наушники • Аксессуары | **БОРТОВЫЕ КОМПЬЮТЕРЫ** — Универсальные компьютеры • Модельные компьютеры • Аксессуары | **GPS НАВИГАТОРЫ** — Портативные GPS • Встраиваемые GPS • GPS модули • GPS трекеры • Антенны для GPS навигаторов • Аксессуары | **ВИДЕОУСТРОЙСТВА** — Видеорегистраторы • Телевизоры и мониторы • Автомобильные ТВ тюнеры • Камеры • Видеомодули • Транскодеры • Автомобильные ТВ антенны • Аксессуары | **ОХРАННЫЕ СИСТЕМЫ** — Автосигнализации • Мотосигнализации • Механические блокираторы • Имобилайзеры • Датчики • Аксессуары | **ОПТИКА И СВЕТ** — Ксенон • Биксенон • Лампы • Светодиоды • Стробоскопы • Оптика и фары • Омыватели фар • Датчики света, дождя • Аксессуары | **ПАРКТРОНИКИ И ЗЕРКАЛА** — Задние парктроники • Передние парктроники • Комбинированные парктроники • Зеркала заднего вида • Аксессуары | **ПОДОГРЕВ И ОХЛАЖДЕНИЕ** — Подогревы сидений • Подогревы зеркал • Подогревы дворников • Подогревы двигателей • Автохолодильники • Автокондиционеры • Аксессуары | **ТЮНИНГ** — Виброизоляция • Шумоизоляция • Тонировочная пленка • Аксессуары | **АВТОАКСЕССУАРЫ** — Радар-детекторы • Громкая связь Bluetooth • Стеклоподъемники • Компрессоры • Звуковые сигналы, СГУ • Измерительные приборы • Автопылесосы • Автокресла • Разное | **МОНТАЖНОЕ ОБОРУДОВАНИЕ** — Установочные комплекты • Обивочные материалы • Декоративные решетки • Фазоинверторы • Кабель и провод • Инструменты • Разное | **ПИТАНИЕ** — Аккумуляторы • Преобразователи • Пуско-зарядные устройства • Конденсаторы • Аксессуары | **МОРСКАЯ ЭЛЕКТРОНИКА И ЗВУК** — Морские магнитолы • Морская акустика • Морские сабвуферы • Морские усилители • Аксессуары | **АВТОХИМИЯ И КОСМЕТИКА** — Присадки • Жидкости омывателя • Средства по уходу • Полироли • Ароматизаторы • Клеи и герметики | **ЖИДКОСТИ И МАСЛА** — Моторные масла • Трансмиссионные масла • Тормозные жидкости • Антифризы • Технические смазки



В магазине «130» вы найдете и сможете купить в Киеве с доставкой по городу и Украине практически все для вашего автомобиля. Наши опытные консультанты предоставят вам исчерпывающую информацию и помогут подобрать именно то, что вы ищете. Ждем вас по адресу

<https://130.com.ua>

FOR CAR USE ONLY/NUR FÜR AUTOMOBIL GEBRAUCH/POUR APPLICATION AUTOMOBILE UNIQUEMENT/PARA USO EN AUTOMÓVILES/SOLO PER L'UTILIZZO IN AUTOMOBILE/ENDAST FÖR BILBRUK/ALLEEN VOOR GEBRUIK IN DE AUTO/ТОЛЬКО ДЛЯ ИСПОЛЬЗОВАНИЯ В АВТОМОБИЛЯХ/DO UŻYCIA TYLKO W SAMOCHODZIE



9-inch Digital Media Station

iLX-F903D



MP3

AAC



- **OWNER'S MANUAL**
Please read before using this equipment.
- **BEDIENUNGSANLEITUNG**
Lesen Sie diese Bedienungsanleitung bitte vor Gebrauch des Gerätes.
- **MODE D'EMPLOI**
Veuillez lire avant d'utiliser cet appareil.
- **MANUAL DE OPERACIÓN**
Léalo antes de utilizar este equipo.
- **ISTRUZIONI PER L'USO**
Si prega di leggere prima di utilizzare il attrezzatura.
- **ANVÄNDARHANDLEDNING**
Innan du använder utrustningen bör du läsa igenom denna användarhandledning.
- **GEBRUIKERSHANDLEIDING**
Lees deze aanwijzingen aandachtig alvorens dit toestel te gebruiken.
- **РУКОВОДСТВО ПО ЭКСПЛУАТАЦИИ**
Прочтите настоящее руководство перед началом использования оборудования.
- **INSTRUKCJA OBSŁUGI**
Prosimy zapoznać się z tą instrukcją przed przystąpieniem do użytkowania urządzenia.

ALPINE ELECTRONICS MARKETING, INC.
1-7, Yukigaya-Otsukamachi, Ota-ku,
Tokyo 145-0067, JAPAN
Phone: 03-5499-4531

ALPINE ELECTRONICS OF AMERICA, INC.
19145 Gramercy Place, Torrance,
California 90501, U.S.A.
Phone 1-800-ALPINE-1 (1-800-257-4631)

ALPINE ELECTRONICS OF AUSTRALIA PTY. LTD.
161-165 Princes Highway, Hallam
Victoria 3803, Australia
Phone 03-8787-1200

ALPINE ELECTRONICS GmbH
Wilhelm-Wagenfeld-Str. 1-3, 80807 München, Germany
Phone 089-32 42 640

ALPINE ELECTRONICS OF U.K. LTD.
Alpine House
Fletchamstead Highway, Coventry CV4 9TW, U.K.
www.alpine.co.uk

ALPINE ELECTRONICS France S.A.R.L.
184 allée des Erables
CS 52016 – Villepinte
95 945 Roissy CDG cedex
FRANCE
Phone : + 33(0)1 48 63 89 89

ALPINE ITALIA S.p.A.
Viale Cristoforo Colombo 8,
20090 Trezzano sul Naviglio MI, Italy
Phone +39 02 484781

ALPINE ELECTRONICS DE ESPAÑA, S.A.
Portal de Gamarra 36, Pabellón, 32
01013 Vitoria (Alava)-APDO 133, Spain
Phone 945-283588

EN

DE

FR

ES

IT

SE

NL

RU

PL

68-3473277-A

130.com.ua

Contents

Operating Instructions

WARNING

Points to Observe for Safe Usage	6
WARNING	6
CAUTION	7
NOTICE	7

Features

Favourite Function	9
About Swiping the Touch Screen	9
Switching the Audio Sources Screen to a Dedicated Screen	10

Getting Started

Location of Controls	11
Turning Power On or Off	11
Turning the System On	11
Initial System Start-Up	12
Adjusting the Volume	12
Lowering Volume Quickly	12
Touch Screen Operation	12
Switching Sources	13
Operating the Function Button on the Audio/Video Main Screen	13
About Basic Operation for List Screen	14
About the Shortcut Setup Screen	14
Sound Setup Function	15
About the Menu Screen	16
Edit Menu	16
About the Indicator Display	17
Opening screen Customisation	17
How to Input Characters and Numbers (Keypad)	18

Favourite Function

Using the Favourite Function	19
Editing the Favourite Screen	19
Registering Items	19
Changing Item Names	20

Changing Icons (only the Shortcut Dialing icons)	20
Changing the Layout	20
Deleting Items	21

Applying Alpine Tunelt App

Adjusting the sound via the Smartphone	22
Facebook Notification Function	22

Setup

Setup Operation	24
-----------------------	----

Wireless (Bluetooth) Setup

Bluetooth Setup	25
Displaying Bluetooth Information	25
Registering the Bluetooth Device	25
Hands-free Device Primary/Secondary Setting	26
iPhone Auto Pairing Setting	26
Phone Setup	26
Setting the Passcode	26
Changing the Character Code of the Phone Book	26
Selecting the Output Speaker	26

General Setup

Sounds Setup	27
Setting the Balance/Fader/Rear Speaker/ Subwoofer	28
Setting the Media Xpander (MX HD)	28
Equalizer Presets	29
Adjusting the Parametric Equalizer Curve (Dual HD EQ)	29
Adjusting the Crossover Settings (X-OVER)	30
Adjusting the Time Correction (TCR)	30
Setting Defeat	30
Setting the Volume for Each Source	31
Adjusting the Caller Level	31
Adjusting the Microphone Level	31
Adjusting the Ring Tone Level	31
Volume Setting	31
Auto Volume Setting	31
Setting the Microphone Effect	31
Default Sound Settings	31
About the Crossover	32
About Time Correction	32
Language Setting	33
Visual Setup	33

Selecting the Visual EQ Mode (Factory's setting)	33	Adjusting the Rear Camera Guide	41
Adjusting Brightness	34	Camera Interrupt Setting (Power OFF Mode)	42
Adjusting Colour of Picture	34	CAN-I/F Setup	42
Adjusting Tint of Picture	34	Setting the Default Vehicle Screen	42
Adjusting Image Contrast	34	Setting the Climate Interrupt Time	42
Adjusting Picture Quality	34	Setting the Parking Sensor Interrupt On/Off	43
Saving and calling the adjusted picture quality	34	Unit Setup	43
Screen Setup	34	Setting the External AP	43
Screen/Lighting Customise	34	Application Setup	43
Switching the Display Colour	35	Android Auto (Optional)	
Setting the Text Scroll	35	What is Android Auto	44
Switching the Artwork Position	35	Activate Android Auto	44
General Setup	35	Apple CarPlay (Optional)	
Format settings	35	Access to Apple CarPlay	44
Setting the Clock Display	35	Radio/RDS	
Setting the Time	36	Radio Basic Operation	
Setting Security code	36	Listening to the Radio	46
About iLX-F903D	36	Presetting Stations Manually	46
Setting Demo mode to Off/On	36	Presetting Stations Automatically	46
Car Setup	37	Tuning to Preset Stations	46
Steering wheel Setting	37	Inputting Frequency Directly and Receiving the Radio Station	47
Installation Setup	37	RDS Operation	
Sources Setup		Turning AF (Alternative Frequencies) On or Off	47
Radio Setup	38	Interruption Function	47
PI SEEK Setting	38	Receiving Traffic Announcement	48
Receiving RDS Regional (Local) Stations	38	News Programme Interruption	48
Switching the Display Language of PTY (Programme Type)	38	Receiving Traffic Information Manually	48
Setting PTY31 (Emergency Broadcast) Reception	38	Selecting the Receivable PTY	48
Setting the TUNER (FM) Tone Quality (Tuner Condition)	38	Displaying Radio Text	48
DAB Setting	39	DAB/DAB+/DMB	
Setting Alarm (Emergency Broadcast) Reception	39	Listening to DAB/DAB+/DMB	49
Setting Announcement Reception	39	Presetting Service	50
Setting the FM Linking ON/OFF (Service Following)	39	Tuning to Preset Service	50
Setting the DAB Antenna ON/OFF	39	Service Component/PTY Search Function	50
AUX Setup	40	Service Search Function	50
Setting the Auxiliary (AUX) Name	40	PTY Search Function	50
Switching the Visual Input Signal System	40	Interruption Function	51
HDMI Setup	40	Receiving Traffic Announcement	51
Apple CarPlay Setup	40	News Programme Interruption	51
System Setup			
Camera Setup	41		
Setting the Camera Input	41		
Setting the Camera Signal Input	41		

Inputting Channel Number Directly and Receiving the Broadcasts	51
Switching to Secondary Service Components	51
Displaying DAB Text	52
About DAB/DAB+/DMB	52

USB Flash drive (Optional)

Playback	54
Fast-forwarding/Fast-reversing (USB Video only)	54
Stopping Playback (USB Video only)	54
Repeat Play	54
Random Play (USB Audio only)	54
Searching for a Desired Song	55
Switching Display Modes (During Video File Play Back)	55
About USB Video format	55

iPod/iPhone (Optional)

Playback	57
Searching for a Music File	57
Quick Search Mode	57
Full Search Mode	57
Alphabet Search Function	58
Repeat Play	58
Random Play (Shuffle)	58

HDMI Device (Optional)

DVD Player Operation

HDMI Operation

Bluetooth Operation

Setup Before Using	60
About Bluetooth	60
About the Hands-free Phone Before Using Bluetooth	60

Hands-free Phone Control

Answering a Call	61
Hanging up the Telephone	61
Call Waiting Function	61
Calling	62
Calling by Favourite Function	62
Making a phone call using the Phone Menu	62

Using Voice Recognition function	63
Using Siri	63
Voice Dial Function	63
Operations During a Conversation	64
Adjusting the Speech Volume	64
Changing the Voice Output	64
DTMF (Touch-Tone) Function	64
Phone Book Function	64
Synchronising the Phone Book	64
Adding the Phone Book	64
Deleting the Phone Book Entries	65
Searching in the Phone Book	65

Bluetooth Audio

Playback	66
Repeat Play	66
Random Play	66
Search Function	66
Connecting a Bluetooth Device	67
Disconnecting the Bluetooth Connection ... Changing the connecting Bluetooth Device	67

Auxiliary Device (Optional)

Operating Auxiliary Devices (Optional)	68
Operating an AUX, AUX DVD or GAME	68

Camera Operation (Optional)

Rear Camera Operation	69
Displaying the Rear Camera Image from the Menu screen	69
Displaying the rear view video while the car is in reverse	69
Guide Display ON/OFF Setting	69
Adjusting the Caution Display Location	69
About the Rear Camera Guide	70

About Vehicle Interlock Function

Vehicle Info mode	72
Function Screen Examples	72

Information

Product Software Update	73
About the Supported Formats	73
About MP3/WMA/AAC/FLAC	73
In Case of Difficulty	75
If this Message Appears	75
Specifications	77

Operating Instructions

WARNING

Points to Observe for Safe Usage

- Read this manual carefully before using this disc and the system components. They contain instructions on how to use this product in a safe and effective manner. Alpine cannot be responsible for problems resulting from failure to observe the instructions in this manual.
- This manual uses various pictorial displays to show you how to use this product safely and to alert you to potential dangers resulting from improper connections and operation. Following are the meanings of these pictorial displays. It is important to fully understand the meanings of these pictorial displays in order to use this manual and the system properly.



WARNING

- Operation of the system while driving is dangerous. Users should stop vehicle before operating the software.
- Road conditions and regulations take precedence over information contained on the map display: observe actual traffic restrictions and circumstances while driving.
- This software is designed for use exclusively in the unit. It cannot and may not be used in conjunction with other hardware.



WARNING

This symbol means important instructions. Failure to heed them can result in serious injury or death.

INSTALL THE PRODUCT CORRECTLY SO THAT THE DRIVER CANNOT WATCH TV/VIDEO UNLESS THE VEHICLE IS STOPPED AND THE EMERGENCY BRAKE IS APPLIED.

It is dangerous for the driver to watch TV/Video while driving a vehicle. Installing this product incorrectly enables the driver to watch TV/Video while driving. This may cause a distraction, preventing the driver from looking ahead, thus causing an accident. The driver or other people could be severely injured.

DO NOT WATCH VIDEO WHILE DRIVING.

Watching the video may distract the driver from looking ahead of the vehicle and cause an accident.

DO NOT OPERATE ANY FUNCTION THAT TAKES YOUR ATTENTION AWAY FROM SAFELY DRIVING YOUR VEHICLE.

Any function that requires your prolonged attention should only be performed after coming to a complete stop. Always stop the vehicle in a safe location before performing these functions. Failure to do so may result in an accident.

DO NOT FOLLOW ROUTE SUGGESTIONS IF THE NAVIGATION SYSTEM INSTRUCTS YOU TO PERFORM AN UNSAFE OR ILLEGAL MANEUVER, OR PLACES YOU IN AN UNSAFE SITUATION OR AREA.

This product is not a substitute for your personal judgment. Any route suggestions by this system should never supersede any local traffic regulations or your personal judgement or knowledge of safe driving practise.

KEEP THE VOLUME AT A LEVEL WHERE YOU CAN STILL HEAR OUTSIDE NOISES WHILE DRIVING.

Excessive volume levels that obscure sounds such as emergency vehicle sirens or road warning signals (train crossings, etc.) can be dangerous and may result in an accident. LISTENING AT LOUD VOLUME LEVELS IN A CAR MAY ALSO CAUSE HEARING DAMAGE.

MINIMIZE DISPLAY VIEWING WHILE DRIVING.

Viewing the display may distract the driver from looking ahead of the vehicle and cause an accident.

DO NOT DISASSEMBLE OR ALTER.

Doing so may result in an accident, fire or electric shock.

USE ONLY IN CARS WITH A 12 VOLT NEGATIVE GROUND.

(Check with your dealer if you are not sure.) Failure to do so may result in fire, etc.

KEEP SMALL OBJECTS SUCH AS SCREWS OUT OF THE REACH OF CHILDREN.

Swallowing them may result in serious injury. If swallowed, consult a physician immediately.

USE THE CORRECT AMPERE RATING WHEN REPLACING FUSES.

Failure to do so may result in fire or electric shock.

DO NOT BLOCK VENTS OR RADIATOR PANELS.

Doing so may cause heat to build up inside and may result in fire.

USE THIS PRODUCT FOR MOBILE 12V APPLICATIONS.

Use for other than its designed application may result in fire, electric shock or other injury.

MAKE THE CORRECT CONNECTIONS.

Failure to make the proper connections may result in fire or product damage.

BEFORE WIRING, DISCONNECT THE CABLE FROM THE NEGATIVE BATTERY TERMINAL.

Failure to do so may result in electric shock or injury due to electrical shorts.

DO NOT ALLOW CABLES TO BECOME ENTANGLED IN SURROUNDING OBJECTS.

Arrange wiring and cables in compliance with the manual to prevent obstructions when driving. Cables or wiring that obstruct or hang up on places such as the steering wheel, shift lever, brake pedals, etc. can be extremely hazardous.

DO NOT SPLICE INTO ELECTRICAL CABLES.

Never cut away cable insulation to supply power to other equipment. Doing so will exceed the current carrying capacity of the wire and result in fire or electric shock.

DO NOT DAMAGE PIPE OR WIRING WHEN DRILLING HOLES.

When drilling holes in the chassis for installation, take precautions so as not to contact, damage or obstruct pipes, fuel lines, tanks or electrical wiring. Failure to take such precautions may result in fire.

DO NOT USE BOLTS OR NUTS IN THE BRAKE OR STEERING SYSTEMS TO MAKE GROUND CONNECTIONS.

Bolts or nuts used for the brake or steering systems (or any other safety-related system), or tanks should NEVER be used for installations or ground connections. Using such parts could disable control of the vehicle and cause fire etc.

DO NOT INSTALL IN LOCATIONS WHICH MIGHT HINDER VEHICLE OPERATION, SUCH AS THE STEERING WHEEL OR SHIFT LEVER.

Doing so may obstruct forward vision or hamper movement etc. and results in serious accident.

**CAUTION**

This symbol means important instructions. Failure to heed them can result in injury or material property damage.

HALT USE IMMEDIATELY IF A PROBLEM APPEARS.

Failure to do so may cause personal injury or damage to the product. Return it to your authorized Alpine dealer or the nearest Alpine Service Centre for repairing.

HAVE THE WIRING AND INSTALLATION DONE BY EXPERTS.

The wiring and installation of this unit requires special technical skill and experience. To ensure safety, always contact the dealer where you purchased this product to have the work done.

USE SPECIFIED ACCESSORY PARTS AND INSTALL THEM SECURELY.

Be sure to use only the specified accessory parts. Use of other than designated parts may damage this unit internally or may not securely install the unit in place. This may cause parts to become loose resulting in hazards or product failure.

ARRANGE THE WIRING SO IT IS NOT CRIMPED OR PINCHED BY A SHARP METAL EDGE.

Route the cables and wiring away from moving parts (like the seat rails) or sharp or pointed edges. This will prevent crimping and damage to the wiring. If wiring passes through a hole in metal, use a rubber grommet to prevent the wire's insulation from being cut by the metal edge of the hole.

DO NOT INSTALL IN LOCATIONS WITH HIGH MOISTURE OR DUST.

Avoid installing the unit in locations with high incidence of moisture or dust. Moisture or dust that penetrates into this unit may result in product failure.

**NOTICE**

Product Cleaning

Use a soft dry cloth for periodic cleaning of the product. For more severe stains, please dampen the cloth with water only. Anything else has the chance of dissolving the paint or damaging the plastic.

Temperature

Be sure the temperature inside the vehicle is between +45°C (+113°F) and 0°C (+32°F) before turning your unit on.

Maintenance

If you have problems, do not attempt to repair the unit yourself. Return it to your Alpine dealer or the nearest Alpine Service Station for servicing.

Protecting the USB connector

- Only an iPod/iPhone, Android™ smartphone or USB flash drive can be connected to the USB connector on this unit. Correct performance using other USB products cannot be guaranteed.
- If the USB connector is used, be sure to use only the supplied connector cable with the unit. A USB hub is not supported.
- Depending on the connected USB flash drive, the unit may not function or some functions may not be performed.
- The audio file format that can be played back on the unit is MP3/WMA/AAC/FLAC.
- Artist/song name, etc., can be displayed. Certain, special characters may not be correctly displayed.



CAUTION

Alpine accepts no responsibility for lost data, etc., even if data, etc., is lost while using this product.

On Handling USB Flash drive

- This unit can control a memory storage device that supports the USB Mass Storage Class (MSC) protocol. Playable audio file formats are MP3, WMA, AAC and FLAC.
 - USB Flash drive function is not guaranteed. Use USB flash drive according to the terms of agreement. Read the USB flash drive Owner's Manual thoroughly.
 - Avoid usage or storage in the following locations:
 - Anywhere in the car exposed to direct sunlight or high temperatures.
 - Anywhere the possibility of high humidity or corrosive substances are present.
 - Fix the USB flash drive in a location where driver operation will not be hindered.
 - USB Flash drive may not function correctly at high or low temperature.
 - Use only certified USB flash drive. Note that even certified USB flash drive, may not function correctly depending on its type or state.
 - Depending on the settings of the USB flash drive type, memory state or encoding software, the unit may not play back or display properly.
 - USB Flash drive may take time to start playback. If there is a particular file other than audio in the USB flash drive, it may take considerable time before the file is played back or searched.
 - The unit can play back "mp3," "wma" or "m4a" file extensions.
 - Do not add the above extensions to a file other than audio data. This non-audio data will not be recognised. The resulting playback may contain noise that can damage speakers and/or amplifiers.
 - It is recommended to back up important data on a personal computer.
 - Do not remove the USB device while playback is in progress. Change SOURCE to something other than USB, then remove the USB device to prevent possible damage to its memory.
- *Windows Media, and the Windows logo are trademarks, or registered trademarks of Microsoft Corporation in the United States and/or other countries.*
 - *Apple, iPhone, iPod, and iPod touch are trademarks of Apple Inc., registered in the U.S. and other countries. Apple CarPlay is a trademark of Apple Inc.*
 - *Use of the Apple CarPlay logo means that a vehicle user interface meets Apple performance standards. Apple is not responsible for the operation of this vehicle or its compliance with safety and regulatory standards. Please note that the use of this product with iPhone, or iPod may affect wireless performance.*
 - *"Made for iPod," and "Made for iPhone," mean that an electronic accessory has been designed to connect specifically to iPod, or iPhone, respectively, and has been certified by the developer to meet Apple performance standards. Apple is not responsible for the operation of this device or its compliance with safety and regulatory standards. Please note that the use of this accessory with iPod, or iPhone may affect wireless performance.*
 - *Google, Android, Android Auto, Google Play and other marks are trademarks of Google LLC.*
 - *The Bluetooth® word mark and logos are registered trademarks owned by the Bluetooth SIG, Inc. and any use of such marks by Alpine Electronics, Inc. is under licence.*
 - *The terms HDMI and HDMI High-Definition Multimedia Interface, and the HDMI Logo are trademarks or registered trademarks of HDMI Licensing, LLC in the United States and other countries.*
 - *MPEG Layer-3 audio coding technology licensed from Fraunhofer IIS and Thomson. Supply of this product only conveys a licence for private, non-commercial use and does not convey a licence nor imply any right to use this product in any commercial (i.e. revenue-generation) real time broadcasting (terrestrial, satellite, cable and/or any other media), broadcasting/streaming via internet, intranets and/or other networks or in other electronic content distribution systems, such as pay-audio or audio-on-demand applications. An independent licence for such use is required. For details, please visit <http://www.mp3licensing.com>*

Features

The following screen examples used in this manual are for reference only. They may differ from the actual screen displays.

Favourite Function

Frequently used functions can be easily recalled. Register them to the Favourite screen. For details, see “Favourite Function” (page 19).

■ Favourite screen example



- Frequently used functions and useful functions can be customised for your convenience.
- You can register up to 54 functions.
- You cannot register a function more than once.

About Swiping the Touch Screen

You can change a screen or a page by swiping the touch screen vertically or horizontally with your finger. For details, see “Touch Screen Operation” (page 12).

Swipe the display with your finger lightly.



Switching the Audio Sources Screen to a Dedicated Screen

You can switch the Audio Sources screen to a dedicated screen by touching the icon on one of the three edges of the screen, or by swiping vertically or horizontally. For details on how to swipe the screen, see “Touch Screen Operation” (page 12).

Shortcut Setup Screen (page 14)



You can set the Sound Setup.

<Audio Sources Screen>
(USB Audio)



Preset button or Quick Search mode Screen*1



Menu Screen*2 (page 16)



You can make settings on the Menu Screen.

*1 The Search mode differs depending on the audio source. For details, see the operating instructions of the audio source.

*2 The screen also switches by pressing the  (MENU) button.

Getting Started

Location of Controls

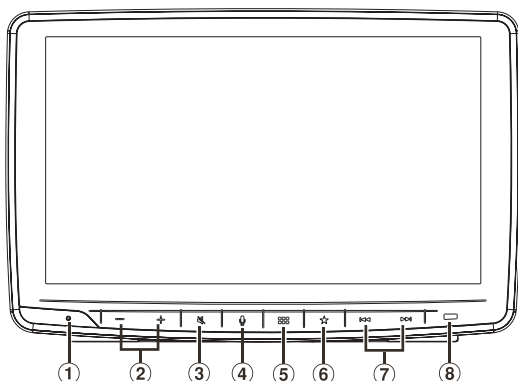

- ① **RESET switch**
The system of this unit is reset.
- ② **-/+ (DOWN/UP) button**
Press to adjust the volume.
- ③ **MUTE button**
Press to activate/deactivate the mute mode.
- ④ **button**
Depending on the connected smartphone, press to recall Siri function or voice recognition mode.
- ⑤ **MENU/(Power Off) button**
Recalls the Menu screen.
Press and hold this button for at least 5 seconds to turn the power off.
- ⑥ **★ (Favourite) button**
Recall the Favourite screen.
Press and hold for at least 2 seconds to recall the Vehicle Info mode screen. (CAN-I/F BOX should be connected.)
- ⑦ **▶▶ / ◀◀ button**
Press to seek up/down a station in radio mode or up/down a track, chapter, etc., in other audio/visual sources.
- ⑧ **Dimmer Sensor**
Sense the brightness of the car interior.

About the button descriptions used in this Owner's Manual

The buttons found on the face of the unit are expressed in bold (e.g. MENU). The buttons found on the touch-screen display are shown in bold within brackets, [] (e.g. [X]).

Turning Power On or Off

Some of this unit's functions cannot be performed while the vehicle is in motion. Be sure to stop your vehicle in a safe location and apply the parking brake, before attempting these operations.

- 1 **Turn the ignition key to the ACC or ON position.**
The system turns on.
 - When turned on, the system displays the last screen that was displayed before the ignition key was turned off. For example, if the unit is in radio mode when ignition is turned off, it will remain in radio mode when ignition is turned back on.
- 2 **Press and hold the MENU/(Power Off) button for at least 5 seconds to turn the power off.**
 - The unit can be turned on by pressing any button.
 - The unit is a precision device. Careful handling of the unit should provide you with years of trouble-free operation.

Turning the System On

With the Alpine system, when the ignition key is turned to ACC or ON, the opening screen will be automatically displayed.

When the system is used for the first time, the language selection menu is displayed. Swipe the Language list screen vertically, then touch your choice from the list of 23 languages.



After selecting the language, the time setting screen is displayed. **Touch [<] or [>] of "Hour", "Minute" to adjust the time, then touch [OK] to confirm.**
Touch [Reset] to reset the time.

- The GPS antenna should be connected before adjusting the time.
- Some of this unit's functions cannot be performed while the vehicle is in motion. Be sure to stop your vehicle in a safe location and apply the parking brake before attempting these operations.

Initial System Start-Up

Be sure to press the **RESET** switch when using the unit for the first time, after changing the car battery, etc.

- 1 Turn off the unit power.
- 2 Press the **RESET** switch with a ballpoint pen or similar pointed object.

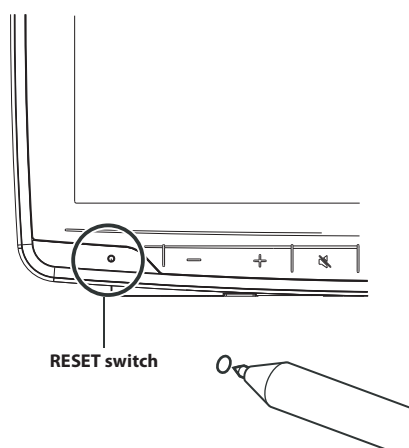

Adjusting the Volume

Adjust the volume by pressing **-/+**.

Volume decreases/increases continuously by pressing and holding **-/+**.

Volume: 0 - 35

Lowering Volume Quickly

Audio Mute function instantly lowers the volume level to 0.

- 1 Press the **MUTE** button to activate the MUTE mode. The audio level will be 0.
- 2 Pressing the **MUTE** button again will bring the audio back to its previous level.

Touch Screen Operation

You can operate the system by using the touch panel on the screen.

- Be sure to touch the onscreen button lightly with the pad of your finger to avoid scratching the display.

Touch operation

Touch a button or list item on the screen lightly.



- If you touch a button and there is no reaction, remove your finger.
- Onscreen buttons that cannot be operated are dimmed.

Swipe operation

Move your finger lightly with a swipe.



Drag & Drop operation

Touch and hold the desired item, then drag it to its new location by moving your finger, then release your finger to place the item.

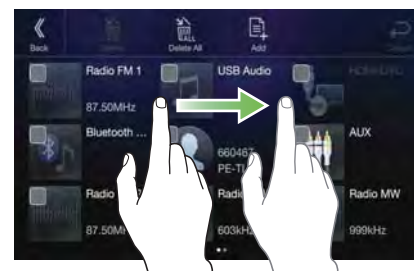

- It is not possible to narrow the screen with two fingers (pinch in) or spread the screen (pinch out).

Switching Sources

Switching Sources from the Menu screen

1 Press the (MENU) button.

The menu screen is displayed.

- You can also display the menu screen by touching the lower part of the Audio source screen or by swiping upward.

The Audio source selecting area



Radio → DAB → USB/iPod*1 → HDMI*1,2 → AUX*2,3 → Bluetooth Audio*1 → Apple CarPlay Music/Google Play Music*4 → Radio

*1 When no USB flash drive/iPod/HDMI device/Smartphone/Bluetooth compatible device is connected, this option is not available.

*2 The name set for "HDMI Setup (page 40)/AUX Setup" is displayed.

*3 When AUX is set to "Off" this option is not available. (page 40)

*4 Available when Apple CarPlay is used/Android smartphone which installed Android Auto App is connected.

To play Apple CarPlay music shall impact iPod source when an iPhone 5 or later is connected and vice versa. Refer to "Apple CarPlay Setup" (page 40).

2 Touch your desired source in the Audio source selecting area.

- In the menu screen, you can change the Audio source directly or change the order in which sources change. For details, see "About the Menu Screen" (page 16).

Operating the Function Button on the Audio/Video Main Screen

Using the Function button on the Audio/Visual main screen.

Touch [] to change to the Function mode.

Radio main screen example



Function mode

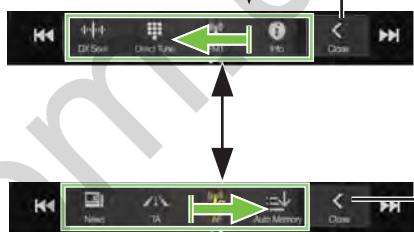

Swipe to the right or left to change to the Function mode.

To close the Function mode, touch [].

- Depending on the Audio source, the Function mode displays from the beginning.

About Basic Operation for List Screen

Basic operations on the Setup list screen and the Search list screen.
How to display on the list screen differs depending on the selected item.

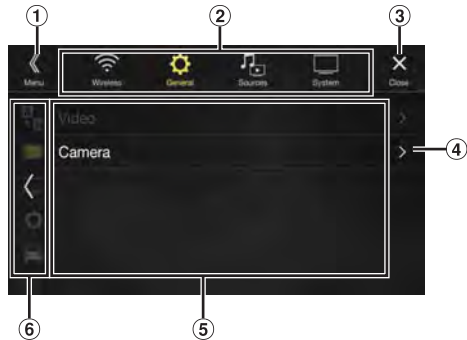

- ① Switches to the menu screen or the previous screen.
- ② Item select button
- ③ Closes the window.
- ④ Displays the next list page.
 - When the next selection item does not exist, the list item is not displayed.
- ⑤ Lists items for selection
 - When there are more than five list items, the page can be changed by swiping vertically.
- ⑥ Returns to the list screen of the page that you touched.
 - The list screens that can be displayed are up to the 2 previous pages. If you touch [<], you can recall your desired page.
- ⑦ Changes the page of the Item select button ② above.
 - “•” indicates the total number of pages, “○” indicates the location of the current page.
- ⑧ List screen close button
 - Touch or swipe to the left on the search screen, etc. to close the list screen.

About the Shortcut Setup Screen

Displaying the Sound Setup screen.

Touch the upper part of the Audio source screen or swipe downward.



The Sound Setup screen is displayed.

■ Sound Setup screen (Tone Adjustment mode) example



- ① Button for Display Off*
 - To cancel Display Off mode, touch the screen or press any button.
 - Display Off mode is cancelled when the power or ACC is turned off.
 - When the gear lever is shifted to the reverse (R) position and the rear camera is connected, the rear camera image is displayed.
 - When a call is received on a Bluetooth-connected phone, the incoming call screen is displayed.
- ② Displays the registered Bluetooth Device List screen.
 - See “Registering the Bluetooth Device” (page 25).
- ③ Touch this or swipe upward to change to the currently playing source screen.
- ④ Displays the Hands-free Device Primary/Secondary setting screen.
 - See “Hands-free Device Primary/Secondary Setting” (page 26).

* Display Off mode

- To cancel Display Off mode, touch the screen or press any button.
- Display Off mode is cancelled when the power or ACC is turned off.
- When the gear lever is shifted to the reverse (R) position and the rear camera is connected, the rear camera image is displayed.
- When a call is received on a Bluetooth-connected phone, the incoming call screen is displayed.

Sound Setup Function

■ Tone Adjustment mode

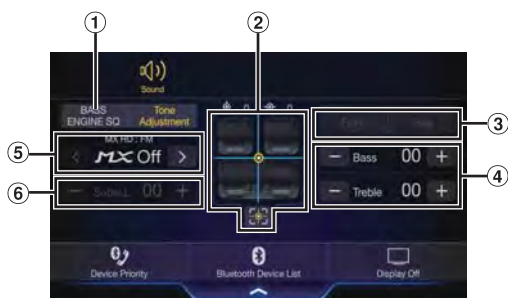

■ BASS ENGINE SQ mode



- ① Button for changing the BASS ENGINE SQ mode screen
- ② Balance/Fader Image area*1
 - To reset to the initial settings (Balance: 0, Fader: 0), touch [↺↻].
- ③ Buttons for switching between Front/Rear when adjusting Bass/Treble*2
- ④ Buttons for adjusting Bass Level/Treble Level*3, 4
- ⑤ Buttons for adjusting Media Xpander *1, 3
- ⑥ Buttons for adjusting Subwoofer Level *1, 3, 5
- ⑦ Button for changing the Tone Adjustment mode screen
 - If changing to the Tone Adjustment mode, BASS ENGINE SQ mode will be disabled.
- ⑧ Buttons for adjusting the BASS ENGINE Level*4
- ⑨ Buttons for selecting the BASS ENGINE type *4

*1 You can perform a more detailed set up in "Sounds Setup" (page 27).

*2 You cannot switch when Front/Rear Sync in "Adjusting the Parametric Equalizer Curve (Dual HD EQ)" (page 29) is "On."

*3 When you switch to the BASS ENGINE SQ mode, the value you have set is ignored.

*4 When the Defeat setting is "On," you cannot perform the set up.

*5 If the Subwoofer setting is "Off," the setting cannot be changed. See "Turning Subwoofer ON/OFF" (page 28).

Adjusting Bass Level/Treble Level

Bass Level and Treble Level can be set for each front seat and for each rear seat by touching [Front] or [Rear].

Setting item:

Bass / Treble

Setting contents:

-14 to +14 (Initial setting: 0)

- When the Sound Setup of the Shortcut Setup is selected to "BASS ENGINE SQ," you cannot perform the set up.
- Adjustment cannot be performed when Defeat is set to "On."
- The Bass adjusted setting value is interlinked with Band2 of Dual HD EQ, and the Treble adjusted setting value is interlinked with Band8.

Setting the BASS ENGINE SQ

Setting the BASS ENGINE Type

Creating the ideal Bass impact for your musical taste using BASS ENGINE SQ.

Setting contents:

Standard (Initial setting) / Punch / Rich / Mid Bass / Low Bass

Standard: Mild low-end boost with mid-range focus for front-centre staging.

Punch: Mid-bass punched up with mid-range impact.

Rich: Accented highs and mid-bass giving outstanding balance for all types of music.

Mid Bass: Strong high frequency emphasis with mid-bass boost for more low-end attack.

Low Bass: Strong, low-bass boost with extended highs for a very dynamic sound.

Adjusting the BASS ENGINE Level

You can adjust the BASS ENGINE Level.

Setting item:

BASS ENGINE Level

Setting contents:

0 to 6 (Initial setting: 3)

- The BASS ENGINE Level 0 of the BASS ENGINE SQ is common to all the types.

■ About setup when the external power amplifier is connected

In order to optimise the BASS ENGINE SQ mode, we recommend the following procedure to set up the power amplifier.

Use your favourite music to make the following amplifier adjustment.

- 1) Set GAIN of the power amplifier to "MIN."
- 2) Set the Crossover Mode Sector switch to "OFF"
 - If the switch has no "OFF" position, set as near as possible to full range.
- 3) Set the BASS ENGINE Level to "03."
- 4) Play a song of the genre you frequently listen to, and adjust GAIN of the power amplifier.

About the Menu Screen

In the menu screen, you can select the audio source and perform various setups or operations on the unit.

Press the (MENU) button.

The menu screen is displayed.

- You can also display the menu screen by touching the lower part of the Audio source screen or by swiping upward.



Menu screen example



- Displays the currently playing audio source.
- Displays the total number of the audio sources that can be selected. Also displays the current position, counting from the leftmost audio source.
- Touch or swipe downward to return to the Audio source screen.
- Audio source select area
 - Swiping to the right or left in the Audio source select area, you can change one audio source at a time. Moreover, swiping to the right or left outside the Audio source select area (upper and lower sides), you can change pages of the Audio source select area.
 - The source icon displayed in the Audio source select area is the one checked on the Edit menu screen. For details on how to display/hide the source icon, see "Edit Menu" (page 16).
- Displays Preset No, and information of the Search mode, etc., located in the middle of the Audio source select area.
 - Touch the desired preset number or the Search mode to change the audio source directly.
 - The displayed information differs depending on the audio source. Some sources are not displayed.
- Touch to display more icons. (Displayed only when icons' number over 5.)
- Camera button*1
 - Displays camera images. (page 69)
- Setup button
 - Displays the Setup screen. (page 24)
- Vehicle Info button
 - Displays the Vehicle Info mode screen. (page 72)

10 Phone button*2

Displays the Phone menu screen. (page 60)

- Depending on the setting and connected devices, the displayed icons and orders may differ. Touch **6** to display more icons such as [Notifications]*3, [Android Auto]*4 and [Apple CarPlay]*5.

*1 Displays when the Camera Select is set to "Rear." (page 41)

*2 Displays when the Bluetooth setting is set to "On." (page 25)

*3 Use to display the Facebook Notification List on the connected smartphone via this unit. (page 23)

Displays when Alpine TuneIt App is set to "USB (iPhone)" or "Bluetooth (Android)," and when a smartphone with Alpine TuneIt App installed is connected. (page 22)

*4 Displays the Android Auto screen, displayed when an Android Smartphone installed Android Auto App is connected. (page 44)

*5 Displays the Apple CarPlay screen, displayed when Apple CarPlay is turned on and an iPhone 5 or later is connected. (page 44)

Edit Menu

In the Edit Menu screen, you can change the audio source order or set the display/hide settings.

1 Touch the desired source icon in the Menu screen for at least 2 seconds.

A checkbox (or) is displayed on the upper left area of the source icon and switches to the edit mode.



- The source icon displayed in the Edit Menu screen is displayed only when usable setup and conditions of each Audio source are fulfilled. For details on setup and conditions of each audio source, see "Switching Sources" (page 13).

Changing the order of Audio source

Drag and drop the source icon to the desired location.

Hiding/Displaying Audio source

Place a check in the checkbox () to display the Audio source icon. Uncheck the checkbox () to hide it.

- You cannot hide the icon of a source that is currently playing.

2 Touch [Done].

The editing content is confirmed, and returns to the menu screen.

- Editing here is reflected in the order of Audio source. (page 13)

About the Indicator Display

The Indicator Bar at the bottom of the screen displays various types of information, like the current time.



- ① Lights up when connected to a Bluetooth compatible device. (Does not display when connection is set to OFF.)
 : Bluetooth connection to audio device
 : Bluetooth connection to Hands Free Phone
 Blinks while reconnecting.
- ② Indicates the battery level of the connected Bluetooth device.

Battery Level	Level 3	Level 2	Level 1	No Battery
Icon				

This may not be displayed depending on the connected Bluetooth device. Whenever one battery level decreases, the alarm sounds.

- ③ Indicates the signal strength level of the connected Bluetooth compatible device.
 Displayed when Bluetooth setting is ON.

0	1	2	3	No Service
				No Service

- ④ The clock display
 You can switch between the 12 hour display and 24 hour display options.
 For details, refer to "Setting the Clock Display" (page 35).
- ⑤ BLUETOOTH devices Name*

* When you connect two Hands-Free Phones, the information of the Bluetooth device set to Primary is displayed.

Opening screen Customisation

You can set a BMP image that is stored on a USB flash drive as the opening screen.

This setting requires the following image format, folder name and file name.

Usable file format:

- BMP image
- Image size: 800 × 480 pixels (RGB 24 bit or less/number of colour bit: 24, 8, 1 bit)
- Compression format: non-compressed
- Folder name*¹: **OPENINGFILE**
- File name*²: **openingfile.bmp**

- 1 Connect the USB flash drive to the USB extension cable.**
 A message confirming the opening screen change is displayed.
- 2 Touch [OK].**
 An update indicator "⌂" (Loading)" is displayed, and update for the opening screen starts.
- 3 After the update is complete, the following message is displayed.*³**
 "Customisation succeeded. Please remove USB memory and press OK."
- 4 After removing the USB flash drive, touch [OK].**
 The opening screen setting is complete.

*¹ Be sure to save the folder to the first layer of the USB flash drive.

*² Only one BMP image can be set as the opening screen.

*³ If "Customisation failed," is displayed, touch [OK] and then check that the folder name, file name and file format are correct.

- Do not perform the following actions during the update.
 - Do not turn off the ACC to the car.
 - Do not unplug the USB flash drive.
 - Do not turn off or operate the unit.
- To return the opening screen to its original image, you must Clear All Settings. Be careful of this operation, as your other settings are also initialised. For details, see "Initializing the System" (page 36).

How to Input Characters and Numbers (Keypad)

The displayed screens and procedures may vary slightly depending on the function used, but the basic input method is the same.



- ① Input screen area.
- ② Cursor position alteration switch
- ③ Cancel
Keypad mode finishes.
- ④  (Delete)
Returns to the previous character and erases it.
Touching here for more than 2 seconds will erase all input characters.
- ⑤ Input number is confirmed.
- ⑥ Character keypad
- ⑦ Space
- ⑧ Special character selector switch
The Alphanumeric/Special characters/Symbols selection popup is displayed.
Touch the desired character type.

Favourite Function

Using the Favourite Function

This unit enables you to recall functions easily by registering frequently used items such as the Audio source, the Shortcut Dialing icons, etc. to the Favourite screen. You can recall any of these items easily.

- 1 Press the ★ (Favourite) button.
The Favourite screen is displayed.

■ Favourite screen example



- ① Changes to the Edit screen used for registering items or changing names.
- ② Close the Favourite screen.
- ③ Favourite registration item
Swipe to the left and right to change the pages. You can add up to 6 pages.
- ④ Indicates the location of the currently displayed Favourite screen.

- 2 Touch your desired Favourite registered item.
The desired item is displayed.

- When making a phone call by choosing shortcut dialing, after the message of confirmation of outgoing phone calls is displayed, touch [Call]. For details, see "Calling by Favourite Function" (page 62).

Editing the Favourite Screen

- 1 Touch [Edit] (Edit).

A checkbox is displayed on the upper left area of the registration icon and it changes to Edit mode.



Setting item:

Item registration / Item name change / Icon change / Layout change / Item deletion

- 2 After editing is complete, touch [Save] (Save).
- 3 After the caption for the confirmation is displayed, touch [Yes].
- 4 Editing is complete.

- If you touch [Cancel] while editing, the screen switches to the previous Favourite Edit screen.

Registering Items

- 1 Touch [Add] (Add).

The items to be added (categories) are displayed.

- 2 Touch the desired item to be added (category).

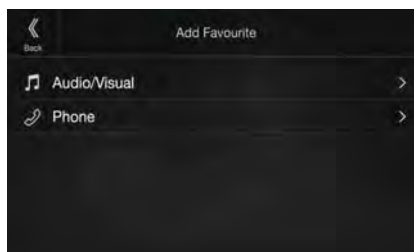

- 3 Choose the desired item to be added.

- You can add up to 54 items.
- You cannot register an item more than once.

■ Audio

[Radio]*1 / [DAB]*2 / [USB/iPod] / [HDMI/DVD] / [AUX] / [Bluetooth Audio] / [Apple CarPlay]*3 / [Android Auto]*3

*1 You can choose the frequency from Preset 1 - 12, registered into each FM1/FM2/MW/LW band of Radio.

*2 You can choose a channel registered to Presets 1 - 18.

*3 You can register now playing Apple CarPlay Music or Google Play Music depending on the connected Smartphone.

- You can also register directly by touching [+★] in the Audio source screen.



However, if it is already registered, [+★] is not displayed.

■ Phone (Shortcut Dialing)*4

You can register the user's shortcut dialing stored in the Phone Book.

- If multiple phone numbers are stored, select a number you want to register.
- You can register directly by touching [+★] of the Contacts list. (page 60)
- You can change the icon you registered. (page 20)

*4 You can only select Phone when a Smartphone is connected. For details on how to register a mobile phone and downloading Phone Book, see "Bluetooth Operation" (page 60).

Changing Item Names

1 Touch the text area of the registered item.



The Input User Name screen (Keypad) is displayed.

2 Input the name and touch [OK].

- For details on how to input characters using the keypad, see "How to Input Characters and Numbers (Keypad)" (page 18).

Changing Icons (only the Shortcut Dialing icons)

You can change the icons of Shortcut Dialing.

The following example explains how to change the Shortcut Dialing icon.

1 Touch the icon that you want to change.



The icon list is displayed.

2 Touch the icon you want to change from the icon list.

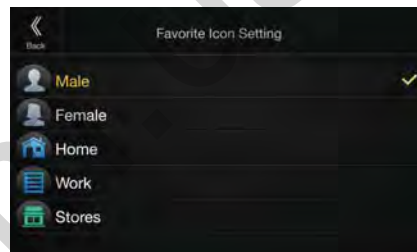

The icon is changed to the selected icon.



Changing the Layout

Drag and drop the item to the desired location.

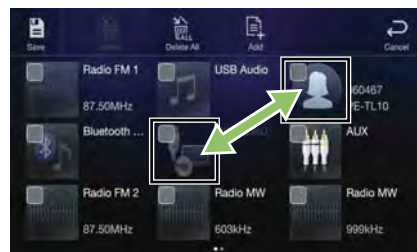

The item location is changed.

- When you move to other pages, switch pages, or when you make a new page and move to another, drag to the end of the screen, and lift your finger after the page changes.

Deleting Items

When deleting a selected item

- 1 Touch the checkbox at the left of the item you want to delete and place a check (✓) in it.



- 2 Touch [] (Delete).
The selected item will be deleted.

When deleting all items

- Touch [] (Delete All).
All items are deleted.

Applying Alpine Tunelt App

This unit's sound tuning is programmable from a connected Smartphone. It is also possible to download specific parameters for certain vehicles from Alpine's Tunelt database stored in the Cloud. Using the Alpine Tunelt App, customised parameters can also be uploaded for others to share and rate.

Through this unit, it is also possible to receive and respond to information from Alpine's Social Network Service (SNS) available through the connected Smartphone.

The installed Alpine Tunelt App should be launched on the Smartphone before connection to the head unit.

Alpine Tunelt App, is downloadable from Apple's App Store; the Android user can download it from Google Play. For details, consult your Alpine dealer.

Before these operations, set TuneIt to USB (iPhone) or Bluetooth (Android) depending on the connected Smartphone. For details, see "Application Setup" (page 43).

- The application programme and related specifications and data may be deleted or terminated without notice.
- Some Alpine Tunelt App functions may not be available if the Smartphone is not in a service area or receives no signal.
- Turn Apple CarPlay to Off before using Alpine Tunelt App. Refer to "Apple CarPlay Setup" (page 40).

Adjusting the sound via the Smartphone

After setting the above procedure, you can adjust the unit's sound function on the Smartphone.

1 Make sure the unit is powered on.

2 Launch the Alpine Tunelt App on the Smartphone. Adjust the unit's sound accordingly on the Smartphone.

- The setting cannot be done on both the Smartphone and this unit at the same time. While the sound function of this unit is set via Smartphone, the sound function settings on the unit will be displayed as "Sound APP Connected."
- In some situations, such as the unit is powered off or during a call, etc., sound setting cannot be done via the Smartphone.
- This function may not be available depending on the paired Smartphone.
- Please obey all local traffic laws while using this function.
- When "Setting the External AP" (page 43) is "On," this function is not available.

Facebook Notification Function

Some functions may be available in a future version of Alpine TuneIt App.

- Depending on the paired Smartphone, the following functions may not be available even though the Alpine TuneIt App version is updated.

Receiving Notification

When the smartphone connected to the unit receives new notifications from Facebook, the unit emits a notification sound or displays the notification screen. Set this up in the Alpine TuneIt App settings.

Notification Incoming screen example



- 1 Poster's picture and name
Touch here to switch to Facebook screen.
Facebook screen is not displayed while driving.
- 2 TTS play (Text To Speech play/stop) button
Touch to play received notification (Depending on the status, operation may not be available). During play mode, touch [TTS Stop] to stop play.
- 3 Like button
For "Like" operation. (Valid when Wall Posts or Comments is received)
- 4 Notifications List button
Touch to switch to Notifications List screen.
- 5 Close button
Close the notification screen.

Touch the desired button to operate.

- A new received Notification prompt will last for 15 seconds. If there is no operation within 15 seconds, the unit will return to normal mode.
- Touching the current main screen will close the notification screen.
- Volume adjustment during TTS play can be adjusted by ---/--- (0-35). Settings will be reflected at the next TTS reproduction.
- The TTS volume is output via the car's front right and left speakers.

Displaying Facebook Screen

During Notification incoming or Notification List screen, you can switch to Facebook screen.

Facebook screen example



- 1 Message content
- 2 Poster's photo
- 3 Close button: Close the Facebook screen.

Touch the poster's picture and name to switch to the Facebook screen.

The detailed information of Notification is displayed.

- Touch [⏪] (Back) to return to previous screen.
- Depending on the status, contents of message and photo may not be displayed.
- In some situations, such as the unit is powered off or during a call, etc., Notification of the Smartphone will not be prompted by this unit.
- Facebook screen is not displayed while driving.

Displaying Notification List

You can view the received Notification from Facebook in the connected Smartphone via this unit.

Notification List screen example

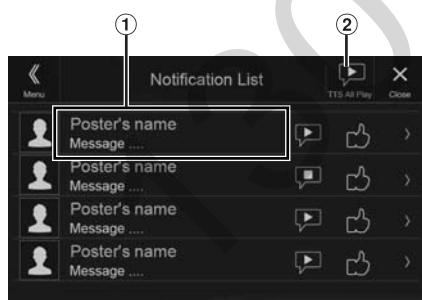

- 1 Poster's Name and Message
Messages are not displayed while driving.
- 2 Touch [TTS All Play]/[TTS All Stop] to play/stop all Notifications.

- You can switch to the Notification List screen from the Menu screen.
- Touch [X] to return to Current screen.
- Depending on the status, some functions may not be available.
- The displayable amount of the Notification list depends on the connected Smartphone.

Setup

Setup Operation

1 Press the (MENU) button.

The Menu screen is displayed.

- You can also display the menu screen by touching the lower part of the Audio source screen or by swiping upward.



[Setup] button

2 Touch [Setup].

The Setup main screen is displayed.



3 Touch the required setting icon on the upper part of the Setup main screen or swipe the list area vertically, then touch the setting item.

Setting items:

Wireless: See "Wireless (Bluetooth) Setup" (page 24).

General: See "General Setup" (page 27).

Sources: See "Sources Setup" (page 37).

System: See "System Setup" (page 41).

Wireless (Bluetooth) Setup

[Wireless] is selected on the Setup main screen in step 3. See "Setup Operation" (page 24).

Wireless Setup Menu screen



<Setting items>

Bluetooth	
Bluetooth Information*1/2	
Set Bluetooth Device*1/2	
Hands-free Device Priority*1/2	
iPhone Auto Pairing*1/2	
Phone	
Passcode Change	
Default Phonebook Encoding	
Phone Speaker	

*1 This setting is only available when "Bluetooth" is set to "On" (☑).

*2 Cannot be adjusted when Apple CarPlay is used/Android smartphone which installed Android Auto App is connected, and "Bluetooth" is fixed to "On".

The following steps 1 to 3 are common to each "Setting item" of Wireless Setup. See each section for details.

1 Select the desired item.

2 To switch the setting, touch [\langle], [\rangle], [$+$], [$-$], or mark the checkboxes "Off" (☐) or "On" (☑).

- If ">" appears, there is a further hierarchy. Touch the desired item.

3 Touch [X] to return to the main source screen.

- To return to the previous List screen, touch [\ll] or [\langle] in the previous page. For details, see "About Basic Operation for List Screen" (page 14).

Bluetooth Setup

[Bluetooth] is selected on the Wireless Setup Menu screen in step 1. See “Wireless (Bluetooth) Setup” (page 24).

You can register and set up Bluetooth compatible devices.



Setting item:

Bluetooth

Setting contents:

Off / On (Initial setting)

Off: Bluetooth function is not used. When the phone function is during using via Apple CarPlay or Android Auto, you cannot select “Off”.

On*: Select when you would like to pair your Bluetooth compatible phone with this unit.

* Turn this setting “On” to automatically connect a registered Bluetooth device whenever this unit is turned ON. See “Registering the Bluetooth Device” if no device is registered.

Displaying Bluetooth Information

Make sure the “Bluetooth” setting is “On” (☑). See “Bluetooth Setup” (page 25).

You can display the Bluetooth device name and device address of this unit.

Setting item:

Bluetooth Information

Registering the Bluetooth Device

Make sure the “Bluetooth” setting is “On” (☑). See “Bluetooth Setup” (page 25).

The Bluetooth device is used when a connectable Bluetooth compatible device is searched and connected from this unit, or a new Bluetooth compatible device is registered.

Setting item:

Set Bluetooth Device

1 Touch [Q] (Search) of “No Device.”



2 Touch [🎵] (Audio), [📞] (Hands-free) or [🎵/📞] (Both) of the device you want to connect from the list.

Audio: Sets for use as an Audio device.

Hands-free: Sets for use as a Hands Free Device.

Both: Sets for use as both an Audio device and Hands Free Device.

- You can register up to 5 Bluetooth compatible mobile phones.
- When you register a Hands-Free Phone for the first time, Primary is set automatically. When you connect two Hands-Free Phones, select “Hands-free” or “Both.” You can then set the priority on the Primary/Secondary setting screen. For details, see “Hands-free Device Primary/Secondary Setting” (page 26).

3 When the device registration is complete, a message appears and the device returns to normal mode.

- The Bluetooth registration process differs depending on the device version and SSP (Simple Secure Pairing). If a 4 or 6 character Passcode appears on this device, enter the Passcode using the Bluetooth compatible device. If a 6 character Passkey appears on this device, make sure the same passkey is displayed on the Bluetooth compatible device and touch “Yes.”
- If all 5 devices have been registered, you cannot register a 6th device. To register another device, you need to delete one of the other 5 devices first.

Setting the Bluetooth Device

Select one of 5 paired Bluetooth compatible devices that you previously registered.

Touch [🎵] (Audio) or [📞] (Hands free) of the device you want to connect from the Paired Device list.



Deleting a Bluetooth Device from the list

You can delete the information of a previously connected Bluetooth compatible device.

1 Touch [🗑️] (Delete) of the Bluetooth compatible device to delete from the Paired Device list.

2 Touch [OK].

- Touching [Cancel] will cancel the setting.

Hands-free Device Primary/Secondary Setting

Make sure the “Bluetooth” setting is “On” (☑). See “Bluetooth Setup” (page 25).

When you connect two Hands-Free Phones, set the priority of the operation and the setting of incoming-outgoing calls.

Setting item:

Hands-free Device Priority

Setting contents:

Primary / Secondary

Touch the checkbox for Primary/Secondary of the device names that are registered to the unit to set them.

- When connected to two hands-free phones, operating restrictions apply to the hands-free phone registered to Secondary. For details, see “Hands-free Phone Control” (page 60).

iPhone Auto Pairing Setting

Make sure the “Bluetooth” setting is “On” (☑). See “Bluetooth Setup” (page 25).

When an iPhone is connected via USB and it is not on the Registered Device list, it will be paired automatically.

Setting item:

iPhone Auto Pairing

Setting contents:

On / Off (Initial setting)

On: Performs iPhone Auto Pairing setting.
Off: Does not perform iPhone Auto Pairing setting.

- This setting supports iPhones with iOS Ver.5.5 or later.
- When more than 5 Bluetooth devices are registered, Auto Pairing does not start.

Phone Setup

[Phone] is selected on the Wireless Setup Menu screen in step 1. See “Wireless (Bluetooth) Setup” (page 24).

You can make various settings for a Bluetooth compatible device.



Setting the Passcode

You can set the code for connecting with a Bluetooth compatible device.

Setting item:

Passcode Change

- 1 Enter a 4-digit passcode (old), and then touch [OK].**
 - The initial number is 0000.
- 2 Enter a 4-digit passcode (new), and then touch [OK].**
- 3 Enter the passcode that you entered in step 2 again, and then touch [OK].**

Changing the Character Code of the Phone Book

You can select the character code that is used when transferring the phone book or history from a mobile phone. If unreadable characters appear in the transferred data, select the correct character code.

Setting item:

Default Phonebook Encoding

Setting contents:

Latin-1 / Latin-9 (Initial setting) / Russian / Chinese / Thai / Arabic / UTF-8 / UTF-16LE / UTF-16BE

Latin-1: ISO 8859-1
Latin-9: ISO 8859-15
Russian: ISO 8859-5
Chinese: GB18030
Thai: CP874
Arabic: CP1256
UTF-8
UTF-16LE
UTF-16BE

Selecting the Output Speaker

You can select which speaker in the car will output the audio from the phone.

Setting item:

Phone Speaker

Setting contents:

All (Initial setting) / Front Left / Front Right / Front Left & Right

All: The sound is output from all speakers in car.
Front Left: The sound is only output from the front left speaker.
Front Right: The sound is only output from the front right speaker.
Front Left & Right: The sound is output from the front left and front right speakers.

- The setting cannot be adjusted during a phone call. Adjust the setting before placing a call.
- This option is not available when “External AP” (page 43) is set to On.

General Setup

[General] is selected on the setup main screen in step 3. See “Setup Operation” (page 24).

■ General Setup Menu screen



<Setting item>

Sounds	
Balance / Fader * ¹	
Rear Speaker* ²	
Subwoofer* ²	
Subwoofer Level* ^{1, 2, 3, 5}	
Subwoofer Phase* ^{2, 3}	
MX HD* ^{1, 4, 5}	
EQ Presets* ^{4, 5}	
Dual HD EQ* ^{4, 5}	
X-OVER* ⁵	
Time Correction (TCR)	
Defeat	
Source Volume Setup	
Caller Level* ⁶	
Microphone Level* ⁶	
Ring Tone Level* ⁶	
Key Sound	
Auto Volume	
Microphone EC/NR	
Default Sound Settings	
Language	
Visual	
Video* ⁷	
Camera* ⁸	
Screen	
Screen/Lighting	
Screen Colour	
Text Scroll	
Artwork Position	
General	
Format Sel.	
Clock Mode	
Time Adjust	
Security Code	
About	
Demo Mode	
Car	
Steering wheel	
Installation Status	

*¹ You can make this setting in the Sound Setup screen of the Shortcut Setup. For details, see “Sound Setup Function” (page 15).

*² You can also make the setting in the Bal./Fad. screen. For details on how to adjust, see “Setting the Balance/Fader/Rear Speaker/Subwoofer” (page 28).

*³ This setting is only available when “Subwoofer” is set to “On” (☑).

*⁴ When the Defeat setting is “On,” you cannot perform the set up.

*⁵ When the Sound Setup of the Shortcut Setup is selected to “BASS ENGINE SQ,” you cannot perform the set up.

*⁶ Not displayed when Apple CarPlay is used/Android smartphone which installed Android Auto App is connected.

*⁷ “Video” can be selected while a video is playing.

*⁸ The camera names are not displayed when Camera Select (page 41) is set to “Off.”

The following steps 1 to 3 are common to each “Setting item” of General Setup. See each section for details.

1 Select the desired item.

2 To switch the setting, touch [⟨], [⏪], [⏩], [−], [+], or mark the checkboxes “Off” (☐) or “On” (☑).

- If “>” appears, there is a further hierarchy. Touch the desired item.

3 Touch [X] to return to the main source screen.

- To return to the previous List screen, touch [⏪] or [⏩] in the previous page. For details, see “About Basic Operation for List Screen” (page 14).

Sounds Setup

[Sounds] is selected on the General Setup Menu screen in step 1. See “General Setup” (page 27).

You can set up items related to the sound quality.

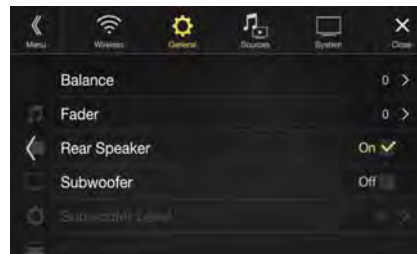

Setting the Balance/Fader/Rear Speaker/Subwoofer

Set Balance/Fader/Rear Speaker/Subwoofer/Subwoofer Level/Subwoofer Phase in the Bal./Fad. screen.

Setting item:

Balance*1 / Fader*1 / Rear Speaker / Subwoofer*2 / Subwoofer Level*1, 2 / Subwoofer Phase*1

*1 When selecting either of the above setting items, the Bal./Fad. screen is displayed.

*2 When the Sound Setup of the Shortcut Setup is selected to "BASS ENGINE SQ," you cannot perform the set up.

■ Fad./Bal. screen



- ① Enables you to change to each setting screen.
- ② Balance/Fader Image area

Setting the Balance/Fader

Touch the desired point within the image area. Or touch [^] [v] [<] [>].

Balance:

L15 to R15

Fader:

F15 to R15

- To reset to the initial setting (Balance: 0, Fader: 0), touch [Centre].

Rear Speaker Setting

You can set the rear speaker output to "Off."

Setting item:

Rear Speaker

Setting contents:

On (Initial setting) / Off

Turning Subwoofer ON/OFF

If an optional subwoofer is connected to the unit, make the following setting.

Setting item:

Subwoofer

Setting contents:

On / Off (Initial setting)

Adjusting the Subwoofer Level

You can set the Subwoofer level when a Subwoofer is connected.

Setting item:

Subwoofer Level

Setting contents:

0 to 15 (Initial setting: 0)

- This setting is only available when "Subwoofer" is set to "On" (☑).

Setting the Subwoofer Phase

The subwoofer output phase is toggled Subwoofer Normal (0°) or Subwoofer Reverse (180°).

Setting item:

Subwoofer Phase

Setting contents:

0° (Initial setting) / 180°

- This setting is only available when "Subwoofer" is set to "On" (☑).

Setting the Media Xpander (MX HD)

Media Xpander (MX HD) makes vocals or instruments sound distinct regardless of the music source. The Radio (FM)/DAB, USB Flash drive and iPod/iPhone, will be able to reproduce the music clearly even in cars with a lot of road noise.

Setting item:

MX HD

- When the Defeat setting is "On," you cannot perform the set up.
- When the Sound Setup of the Shortcut Setup is selected to "BASS ENGINE SQ," you cannot perform the set up.
- The MX HD setting can be performed only when a source is currently selected.

■ Adjustable source (media) and setting value

FM/DAB: Off (Initial setting) / Level1 / Level2 / Level3

The medium to high frequencies become more clear, and produces well balanced sound in all the bands.

Compressed Media: Off (Initial setting) / Level1 / Level2 / Level3

This corrects information that was omitted at the time of compression. This reproduces a well-balanced sound close to the original.

HDMI/AUX: Off (Initial setting) / Compressed Media / Movie / Music

Choose the MX HD mode (Compressed Media, Movie, or Music) that corresponds to the media connected.

(Movie)

The dialog portion of the video is reproduced more clearly

(Music)

This disc contains a large quantity of data such as music clip. MX uses this data to reproduce the sound accurately.

- The effectiveness increases as the MX HD setting value increases Level1 → Level2 → Level3.
- You can set this for each source.
- iPod/iPhone/USB Audio/Bluetooth Audio/Apple CarPlay Music/Google Play Music correspond to Compressed Media.

Equalizer Presets

10 typical equalizer settings are preset at the factory for a variety of musical source material.

Setting item:

EQ Presets

Setting contents:

FLAT (Initial setting) / POP / ROCK / NEWS / JAZZ / ELECTRONIC / HIP HOP / EASY LISTENING / COUNTRY / CLASSICAL

- Only one type can be set to ON.
- When Equalizer Presets is set, the linked Dual HD EQ settings are also changed. We recommend storing Dual HD EQ settings in a Preset in advance.
- The Equalizer Presets setting can be configured when Defeat is "Off"

Adjusting the Parametric Equalizer Curve (Dual HD EQ)

Parametric Equalizer (Dual HD EQ) can adjust the centre frequency/Q Adjustment (bandwidth)/level in the front seats and the rear seats, respectively.

You can adjust only to the approximate frequency zone, but can then compensate by performing advanced correction of the sound.

Setting item:

Dual HD EQ

- When the Defeat setting is "On," you cannot perform the set up.
- When the Sound Setup of the Shortcut Setup is selected to "BASS ENGINE SQ," you cannot perform the set up.

1 Adjust the Dual HD EQ to your preference.



- 1 Front/Rear speaker switching button
Not displayed when Front/Rear Sync is "On" (.
- 2 Front/Rear speaker interlock button
On: When you want the Front and Rear speakers to have the same setting, set to "On" (.
- Off: When you want to set the Front and Rear speakers independently, set to "Off" (.

Adjusting the Band

Touch **[Band]** to select the band to be adjusted.

Band1 → Band2 → ... → Band8 → Band9 → Band1

- You can select a band directly by touching the screen.

Adjusting the Frequency

Touch [**<**] or [**>**] of "Frequency" to adjust the frequency of the selected band.

Adjustable frequency bands:

20 Hz to 20 kHz (in 1/3 octave steps)

Band1:	20 Hz~100 Hz (63 Hz)
Band2:	63 Hz~315 Hz (125 Hz)
Band3:	125 Hz~500 Hz (250 Hz)
Band4:	250 Hz~1 kHz (500 Hz)
Band5:	500 Hz~2 kHz (1 kHz)
Band6:	1 kHz~4 kHz (2 kHz)
Band7:	2 kHz~7.2 kHz (4 kHz)
Band8:	5.8 kHz~12 kHz (8 kHz)
Band9:	9 kHz~20 kHz (16 kHz)

Adjusting the Level

Touch [**-**] or [**+**] of "Level" to adjust the level of selected band.

Setting contents:

-14 to +14 (Initial setting: 0)

Setting the Bandwidth

Touch [**<**] or [**>**] of "Q Adjustment" to select the bandwidth.

Setting contents:

Wide (Initial setting) / Medium / Narrow

2 To adjust another band, repeat step 1, and adjust all bands.

3 To store the adjusted setting value, touch and hold [Preset 1], [Preset 2], or [Preset 3] for at least 2 seconds.

- Band2 and Band8 are the same as the Bass and Treble controls.
- For details on setting Bass and Treble, see "Adjusting Bass Level/Treble Level" (page 15).
- Settings exceeding the frequency of adjacent bands are not available.
- While adjusting the Dual HD EQ, you should consider the frequency response of the connected speakers.
- When the Dual HD EQ is adjusted, the Equalizer Presets are overridden.
- When Equalizer Presets is set, the linked Dual HD EQ settings are also changed. We recommend storing Dual HD EQ settings in a Preset in advance.
- Touch **[Flat]** to initialise all values.

Calling the Dual HD EQ adjusted value

Calling the pre-set Dual HD EQ adjusted value.

Touch [Preset 1], [Preset 2], or [Preset 3] on the Dual HD EQ screen.

The setting stored in the Preset will be recalled.

Adjusting the Crossover Settings (X-OVER)

Before performing the following procedures, see "About the Crossover" (page 32).

Setting item:

X-OVER

- When the Sound Setup of the Shortcut Setup is selected to "BASS ENGINE SQ," you cannot perform the set up.

1 Touch [Channel] to select the channel.

Each time you touch, the channel switches.



- The channel being adjusted is displayed in red.
Front HPF → Rear HPF → Subw. LPF → Front HPF

2 Adjust the crossover to your preference.

Selecting the Cut-Off Frequency

Touch [<] or [>] of "Frequency," and then select the cut-off frequency.

Setting contents:

20 / 25 / 31.5 / 40 / 50 / 63 / 80 (Initial setting) / 100 / 125 / 160 / 200 Hz

Adjusting the Slope

Touch [<] or [>] of "Slope," and then adjust the HPF or LPF slope.

Setting contents:

0 (Initial setting) / 6 / 12 / 18 / 24 dB/oct.

Adjusting the Level

Touch [–] or [+] of "Level," and then adjust the HPF or LPF level.

Setting contents:

-12 to 0 dB (Initial setting: 0)

3 Repeat steps 1 to 2 to make adjustment to the other channels.

4 To store the adjusted setting value, touch and hold [Preset 1], [Preset 2], or [Preset 3] for at least 2 seconds.

- Touch [Flat] to initialise all values.
- If the Rear Speaker setting is "Off," the Rear Speaker setting cannot be edited (page 28).
- If the Subwoofer setting is "Off," the Subwoofer setting cannot be edited (page 28).
- While adjusting the X-OVER you should consider the frequency response of the connected speakers.

Calling the X-OVER adjusted value

Calling the pre-set X-OVER adjusted value.

Touch [Preset 1], [Preset 2], or [Preset 3] on the X-OVER screen.

The setting stored in the Preset will be recalled.

Adjusting the Time Correction (TCR)

Before performing the following procedures, see "About Time Correction" (page 32).

Setting item:

Time Correction



Correction mode

1 Touch the Correction mode button.

The pop up screen for selecting the correction mode is displayed.

2 Touch [ms], [cm] or [inch] to select the mode for making adjustments.

The selected mode is displayed on the Correction mode button.

3 Touch [–] or [+] for each speaker to adjust the time or distance.

0.0 msec to 9.9 msec (0.1 msec/step)

0.0 cm (0.0 inch) to 336.6 cm (132.7 inch) (3.4 cm/step)

All speaker setting values are adjustable in the range of 15 ms or 510 cm.

4 To store the adjusted setting value, touch and hold [Preset 1], [Preset 2], or [Preset 3] for at least 2 seconds.

- Touch [Flat] to set all values to 0.0.
- If the Rear Speaker setting is "Off," the Rear Speaker setting cannot be edited (page 28).
- If the Subwoofer setting is "Off," the Subwoofer setting cannot be edited (page 28).

Calling the Time Correction Value

Calling the pre-set time correction value.

Touch [Preset 1], [Preset 2], or [Preset 3] on the time correction screen.

The setting stored in the Preset will be recalled.

Setting Defeat

If Defeat is "On," MX HD, Equalizer Presets and Dual HD EQ functions are turned Off. This disables any settings made for these functions.

Setting item:

Defeat

Setting contents:

Off (Initial setting) / On

Setting the Volume for Each Source

Setting item:

Source Volume Setup → Radio / DAB / Compressed Media*¹ / iPod Music / AUX / HDMI*² / Bluetooth Audio / Apple CarPlay / Android Auto

Setting contents*³:

-14 to +14 (Initial setting: 0)

Setting the Volume for Apple CarPlay

When an iPhone 5 or later is connected, after touching [Apple CarPlay], you can adjust Media, Phone Calls, Ringtones & Alerts level, Notifications & Guidance level, Siri and Microphone Level for Apple CarPlay mode.

Setting item:

Media / Phone Calls / Ringtones & Alerts / Notifications & Guidance / Siri / Microphone Level

Setting contents for Media:

-14 to +14 (Initial setting: 0)

Setting contents for Ringtones & Alerts:

1 to 6 (Initial setting: 3)

Setting contents for other items:

1 to 11 (Initial setting: 5)

Setting the Volume for Android Auto

When an Android Smartphone is connected, after touching [Android Auto], you can adjust Media, Phone Calls, Ringtones & Alerts level, Notifications & Guidance level, Voice Recognition and Microphone Level for Android Auto mode.

Setting item:

Media / Phone Calls / Ringtones & Alerts / Notifications & Guidance / Voice Recognition / Microphone Level

Setting contents for Media:

-14 to +14 (Initial setting: 0)

Setting contents for Ringtones & Alerts:

1 to 6 (Initial setting: 3)

Setting contents for other items:

1 to 11 (Initial setting: 5)

*1 Compressed Media is the music data in a USB flash drive (MP3/WMA/AAC/FLAC).

*2 The source name set in "HDMI Setup" (page 40) is displayed.

*3 Except for Apple CarPlay/Android Auto mode.

- Settable source differs depending on the connected device and settings.

Adjusting the Caller Level

You can adjust the volume of the incoming call.

Setting item:

Caller Level

Setting contents:

1 to 11 (Initial setting: 5)

Adjusting the Microphone Level

You can adjust the transmit volume, during the call.

Setting item:

Microphone Level

Setting contents:

1 to 11 (Initial setting: 5)

Adjusting the Ring Tone Level

You can adjust the receive volume, during the call.

Setting item:

Ring Tone Level

Setting contents:

1 to 6 (Initial setting: 3)

Volume Setting

You can change the volume of the sound heard when a button is touched.

Setting item:

Key Sound

Setting contents:

0 to 6 (Initial setting: 3)

Auto Volume Setting

The volume of the sound heard is raised automatically according to the noise level by detecting engine noise and road noise.

Setting item:

Auto Volume

Setting contents:

Off (Initial setting) / Low / Middle / High

- The increasing rate of volume becomes large in this order: Low → Middle → High.

Setting the Microphone Effect

Set this item when Apple CarPlay is used/Android smartphone which installed Android Auto App is connected.

You can turn on or off the Microphone Effect.

This setting influences Apple CarPlay/Android Auto mode.

Setting item:

Microphone EC / NR

Setting contents:

On (Initial setting) / Off

Default Sound Settings

You can restore the Dual HD EQ*/X-OVER*/Time Correction*/MX HD Level/Rear Speaker/Subwoofer/Subwoofer Level/Subwoofer Phase to factory settings.

Setting item:

Default Sound Settings

Touch **[Set]**, and the confirmation message appears.

To initialise, touch **[OK]**.

- * The setting values that are stored in Preset 1 to Preset 3 cannot be initialised.

About the Crossover

Crossover (X-OVER):

This unit is equipped with an active crossover. The crossover limits the frequencies delivered to the outputs. Each channel is controlled independently. Thus, each speaker pair can be driven by the frequencies for which they have been optimally designed.

The crossover adjusts the HPF (high pass filter) or LPF (low pass filter) of each band, and also the slope (how fast the filter rolls off the highs or lows).

Adjustments should be made according to the reproduction characteristics of the speakers. Depending on the speakers, a passive network may not be necessary. If you are unsure about this point, please consult your authorized Alpine dealer.

	Cut-off frequency (1/3 octave steps)		Slope		Level
	HPF	LPF	HPF	LPF	
Subwoofer (LPF)	----	20 Hz - 200 Hz	----	0, 6, 12, 18, 24 dB/oct.	0 to -12 dB
Rear speaker (HPF)	20 Hz - 200 Hz	----	0, 6, 12, 18, 24 dB/oct.	----	0 to -12 dB
Front speaker (HPF)	20 Hz - 200 Hz	----	0, 6, 12, 18, 24 dB/oct.	----	0 to -12 dB

Low range High range

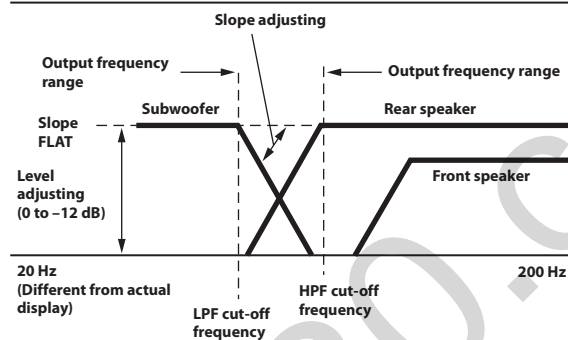

- **HPF (high pass filter):** Cuts the lower frequencies and allows the higher frequencies to pass.
- **LPF (low pass filter):** Cuts the higher frequencies and allows the lower frequencies to pass.
- **Slope:** The level change (in dB) for a frequency change of one octave.
- The higher the slope value, the steeper the slope becomes.
- Adjust the slope to FLAT to bypass the HP or LP filters.
- Do not use a tweeter without the HPF on or set to a low frequency, as it may cause damage to the speaker due to the low frequency content.
- Adjustment should be made according to the recommended crossover frequency of the connected speakers. Determine the recommended crossover frequency of the speakers. Adjusting to a frequency range outside that recommended may cause damage to the speakers. For the recommended crossover frequencies of Alpine speakers, refer to the respective Owner's Manual.

We are not responsible for damage or malfunction of speakers caused by using the crossover outside the recommended value.

About Time Correction

The distance between the listener and the speakers in a car vary widely due to the complex speaker placement. This difference in the distances from the speakers to the listener creates a shift in the sounds image and frequency characteristics. This is caused by the time delay between the sound reaching the listener's right versus the left ear.

To correct this, this unit is able to delay the audio signal to the speakers closest to the listener. This effectively creates a perception of increased distance for those speakers. The listener can be placed at an equal distance between the left and right speakers for optimum staging. The adjustment will be made for each speaker in 3.4 cm steps.

Example 1. Listening Position: Front Left Seat

Adjust the time correction level of the front left speaker to a high value and the rear right to zero or a low value.

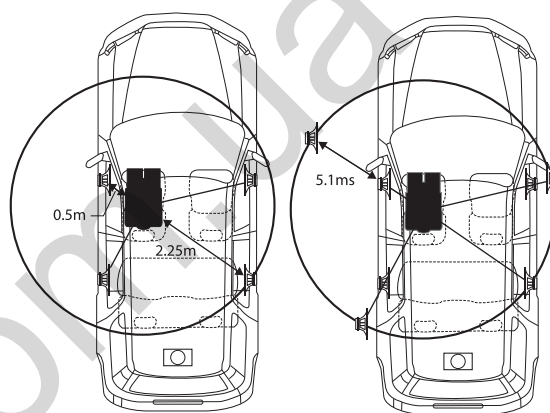

The sound is not balanced because the distance between the listening position and the various speakers is different. The difference in distance between the front left speaker and the rear right speaker is 1.75 m (68-7/8").

Here we calculate the time correction value for the front left speaker in the diagram on the above.

Conditions:

Farthest Speaker – listening position : 2.25 m (88-9/16")

Front left speaker – listening position : 0.5 m (19-11/16")

Calculation: $L = 2.25 \text{ m} - 0.5 \text{ m} = 1.75 \text{ m} (68-7/8")$

Time correction = $1.75 \div 343 * 1,000 = 5.1 \text{ (ms)}$

* Speed of sound: 343 m/s (765 mph) at 20°C

In other words, giving the front left speaker a time correction value of 5.1 ms makes it seem as if its distance from the listener is the same as the distance to the farthest speaker.

Time correction eliminates the differences in the time required for the sound to reach the listening position.

The time of the front left speaker is corrected by 5.1 ms so that its sound reaches the listening position at the same time as the sound of other speakers.

Example 2. Listening Position: All Seats

Adjust the time correction level of each speaker to almost the same level.

- 1 Sit in the listening position (driver's seat, etc.) and measure the distance (in meters) between your head and the various speakers.**
- 2 Calculate the difference between the distance correction value to the farthest speaker and the other speakers.**

$$L = (\text{distance to farthest speaker}) - (\text{distance to other speakers})$$

These values are the time correction values for the different speakers. Setting these values to make each sound reach the listening position at the same time as the sound of other speakers.

Time Correction Value List

Time Difference (msec)	Distance (cm)	Distance (inch)	Time Difference (msec)	Distance (cm)	Distance (inch)
0.0	0.0	0.0	5.1	173.4	68.3
0.1	3.4	1.3	5.2	176.8	69.7
0.2	6.8	2.7	5.3	180.2	71.0
0.3	10.2	4.0	5.4	183.6	72.4
0.4	13.6	5.4	5.5	187.0	73.7
0.5	17.0	6.7	5.6	190.4	75.0
0.6	20.4	8.0	5.7	193.8	76.4
0.7	23.8	9.4	5.8	197.2	77.7
0.8	27.2	10.7	5.9	200.6	79.1
0.9	30.6	12.1	6.0	204.0	80.4
1.0	34.0	13.4	6.1	207.4	81.7
1.1	37.4	14.7	6.2	210.8	83.1
1.2	40.8	16.1	6.3	214.2	84.4
1.3	44.2	17.4	6.4	217.6	85.8
1.4	47.6	18.8	6.5	221.0	87.1
1.5	51.0	20.1	6.6	224.4	88.4
1.6	54.4	21.4	6.7	227.8	89.8
1.7	57.8	22.8	6.8	231.2	91.1
1.8	61.2	24.1	6.9	234.6	92.5
1.9	64.6	25.5	7.0	238.0	93.8
2.0	68.0	26.8	7.1	241.4	95.1
2.1	71.4	28.1	7.2	244.8	96.5
2.2	74.8	29.5	7.3	248.2	97.8
2.3	78.2	30.8	7.4	251.6	99.2
2.4	81.6	32.2	7.5	255.0	100.5
2.5	85.0	33.5	7.6	258.4	101.8
2.6	88.4	34.8	7.7	261.8	103.2
2.7	91.8	36.2	7.8	265.2	104.5
2.8	95.2	37.5	7.9	268.6	105.9
2.9	98.6	38.9	8.0	272.0	107.2
3.0	102.0	40.2	8.1	275.4	108.5
3.1	105.4	41.5	8.2	278.8	109.9
3.2	108.8	42.9	8.3	282.2	111.2
3.3	112.2	44.2	8.4	285.6	112.6
3.4	115.6	45.6	8.5	289.0	113.9
3.5	119.0	46.9	8.6	292.4	115.2
3.6	122.4	48.2	8.7	295.8	116.6
3.7	125.8	49.6	8.8	299.2	117.9
3.8	129.2	50.9	8.9	302.6	119.3
3.9	132.6	52.3	9.0	306.0	120.6
4.0	136.0	53.6	9.1	309.4	121.9
4.1	139.4	54.9	9.2	312.8	123.3
4.2	142.8	56.3	9.3	316.2	124.6
4.3	146.2	57.6	9.4	319.6	126.0
4.4	149.6	59.0	9.5	323.0	127.3
4.5	153.0	60.3	9.6	326.4	128.6
4.6	156.4	61.6	9.7	329.8	130.0
4.7	159.8	63.0	9.8	333.2	131.3
4.8	163.2	64.3	9.9	336.6	132.7
4.9	166.6	65.7			
5.0	170.0	67.0			

Language Setting

The Setup menu, feedback information, etc. for this unit can be changed to appear in the selected language.

Setting item:

Language*¹ (Language*²)

Setting contents:

English / Deutsch / Français / Español /
Português / Italiano / Nederlands / Suomi /
Norsk / Svenska / Dansk / русский язык /
Slovenčina / Polski / Český / Magyar / Ελληνικά /
עברית / العربية / Türkçe / 中文 /
Bahasa Indonesia

*1 Display in the currently selected language.

*2 Always display in English.

Visual Setup

[Visual] is selected on the General Setup Menu screen in step 1. See "General Setup" (page 27).

You can set up items related to an image.

Settable items differ depending on the application.

[Video] (Video media)*³:

Visual EQ / Brightness / Colour / Tint / Contrast / Sharpness

[Camera]*⁴:

Brightness / Colour / Contrast

*3 "Video" can be selected while a video is playing.

*4 The camera names are not displayed when "Off" is set (page 41).

Selecting the Visual EQ Mode (Factory's setting)

You can select a mode suitable for the subject image.

Setting item:

Visual EQ

Setting contents:

Off (Initial setting) / Night / Soft / Sharp / Contrast

Off: Initial Setting

Night: Suitable for movies in which dark scenes frequently appear.

Soft: Suitable for CGs and animated films.

Sharp: Suitable for old movies where images are not clearly shown.

Contrast: Suitable for recent movies.

- To return to the default video settings, set this function to Off. Any Visual EQ selection or changes made are reset their initial settings.

Adjusting Brightness

Setting item:

Brightness

Setting content:

-15 to +15 (Initial setting: 0)

You can adjust the brightness between MIN (-15) and MAX (+15). When it reaches the minimum or maximum point, the display shows "MIN" or "MAX" respectively.

Adjusting Colour of Picture

Setting item:

Colour

Setting content:

-15 to +15 (Initial setting: 0)

You can adjust the colour between MIN (-15) and MAX (+15). When it reaches the minimum or maximum point, the display shows "MIN" or "MAX" respectively.

Adjusting Tint of Picture

Setting item:

Tint

Setting content:

R15 to G15 (Initial setting: 0)

Adjust the Colour from R15 to G15.

Adjusting Image Contrast

Setting item:

Contrast

Setting content:

-15 to +15 (Initial setting: 0)

You can adjust the contrast between MIN (-15) and MAX (+15). When it reaches the minimum or maximum point, the display shows "MIN" or "MAX" respectively.

Adjusting Picture Quality

Setting item:

Sharpness

Setting content:

-5 to +5 (Initial setting: 0)

Picture quality adjustment range is -5 to +5. "SOFT" and "HARD" appear as the minimum and maximum values specified.

Saving and calling the adjusted picture quality

When adjusting audio (video media), you can store the settings made for "Adjusting Brightness, Colour, Tint, Contrast and Sharpness."

Setting item:

Preset 1 / Preset 2

- 1 After completing "Adjusting Brightness, Colour, Tint, Contrast and Sharpness" (page 34), touch and hold [Preset 1] or [Preset 2] to save the settings.
- 2 Touch [Preset 1] or [Preset 2] to call the saved settings.

Screen Setup

[Screen] is selected on the General Setup Menu screen in step 2. See "General Setup" (page 27).

You can set up the brightness, colour, display, etc., of the screen.

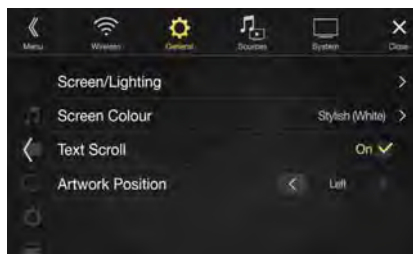

Screen/Lighting Customise

- 1 Touch [Screen/Lighting] in the Display/Key Setup Menu screen.

The Screen/Lighting setup screen appears.

Setting item:

Dimmer / Key Illumination Level / Screen Dimmer Level

Setting the Brightness of the Backlighting

Backlighting is provided by LEDs light built into the liquid crystal panel. The illumination control adjusts the brightness of the backlighting based on the car ambient lighting for easier viewing.

Setting item:

Dimmer

Setting contents:

Auto (Initial setting) / On / Off

- Auto: Adjust the brightness of the background illumination of the monitor automatically to the brightness of the car interior.
- On: Keep the background illumination of the monitor dark.
- Off: Deactivate Auto Dimmer mode to keep the background illumination of the monitor bright.

- When "On" is set, the setting is also applied for the button lighting in "Adjusting the Dimmer of Button Lighting at Night" (page 34), and "Adjusting the Minimum Level of Backlight" (page 35).

Adjusting the Dimmer of Button Lighting at Night

You can adjust the brightness of the button lighting at night with the dimmer.

Setting item:

Key Illumination Level

Setting level:

-2 to +2 (Initial setting: 0)

- This setting is only available when "Dimmer" is set to "On."

Adjusting the Minimum Level of Backlight

You can adjust the brightness of the backlight. This function could be used, for instance, to change the screen brightness while travelling at night.

Setting item:

Screen Dimmer Level

Setting content:

-15 to +15 (Initial setting: 0)

You can adjust the level between MIN (-15) and MAX (+15). When it reaches the minimum or maximum point, the display shows "MIN" or "MAX" respectively.

- This setting is only available when "Dimmer" is set to "On" or "Auto."

Switching the Display Colour

You can choose from 8 different display colours.

Setting item:

Screen Colour

Setting contents:

Blue / Light blue / Aqua blue / Red / Light Green / Green / Amber / White

Setting the Text Scroll

Scroll display is available if folder name, file name or tag information is entered.

Setting item:

Text Scroll

Setting contents:

Off / On (Initial setting)

- Off: Turns off the scroll mode.
On: Turns on the Auto scroll mode. Scroll display is repeated as long as the mode is turned on.

Switching the Artwork Position

You can set the artwork position to the centre or the left.

Setting item:

Artwork Position

Setting contents:

Centre / Left (Initial setting)

General Setup

[General] is selected on the General Setup Menu screen in step 1. See "General Setup" (page 27).

You can set up items related to the clock, etc.



Format settings

The character code to be used for tag text information displayed on the screen can be selected from 7 character codes.

Setting item:

Format Sel.

Setting contents:

Latin-1 / Latin-9 (Initial setting) / Russian / Chinese / Thai / Arabic / Hebrew

- | | |
|----------|--------------|
| Latin-1: | ISO 8859-1 |
| Latin-9: | ISO 8859-15 |
| Russian: | ISO 8859-5 |
| Chinese: | GB18030-2005 |
| Thai: | CP874 |
| Arabic: | CP1256 |
| Hebrew: | CP1255 |

Setting the Clock Display

You can select the clock display type, 12-hour or 24-hour, depending on your preference.

Setting item:

Clock Mode

Setting contents:

12h (Initial setting) / 24h

Setting the Time

Setting item:

Time Adjust

Additional items:

Hour / Minute

Setting content:

AM12 - PM12 or 0-23 / 0-59

Hour: Adjust the hour.

Minute: Adjust the minute.

- Cannot be adjusted while no GPS signal is received.

Setting Security code

You can set the system to be unusable without entering a password. When you turn this setting to "On" and set a password, password input is required when the system is connected to a battery and turned on for the first time.

Setting item:

Security Code

Setting contents:

Off (Initial setting) / On

Setting the password

1 Touch the checkbox "Off" () of the Security Code.

2 After the confirmation message appears, touch [OK].

The password setting screen is displayed.

3 Enter a password, then touch [OK].

- Enter the 6-digit number.
- Input numbers are displayed as "*".
- Touch [] to delete an entered number.

4 Enter the same password again, then touch [OK].

The password is set and the system returns to the General Setup Menu screen, then the checkbox of the Security Code is set to "On" ()

- If you forget a registered password, you can not use this unit. In this case, service will be required.

Clearing the password

1 Touch the checkbox "On" () of the Security Code.

The password setting screen is displayed.

2 Enter the password you have set, then touch [OK].

The password is cleared and the system returns to the General Setup Menu screen, then the checkbox of the Security Code is set to "Off" ()

- Input numbers are displayed as "*".

About iLX-F903D

[About] enables you to check the Serial Number, Firmware Version, Model Name, and to initialise various settings.

Displaying the Product Information

You can view the version information of this product. Make note of this information and refer to it whenever you contact Alpine Tech Support or an Alpine-authorized dealer.

Setting contents:

Serial Number / Firmware Version / Model Name

Initializing the System

You can initialise all data, to restore the factory settings. Remove the USB flash drive, etc. from the system before operation

Setting item:

Clear All Settings

1 Touch [Reset] of "Clear All Settings."

2 After the confirmation message appears, touch [OK].

The confirmation screen appears again.

3 Touch [OK].

The system starts initialisation.

- Do not turn on/off the power, change the ignition key position or remove the screen panel until system restart is completed.

Setting Demo mode to Off/On

This unit has a Demonstration feature for the display. When you install and use the unit for the first time, the unit will enter demo mode automatically. To quit demo mode, set Demo mode to Off.

Setting item:

Demo mode

Setting contents:

Off / On (Initial setting)

- If you perform an operation during the Demo mode, the demonstration is temporarily stopped.

Car Setup

[Car] is selected on the General Setup Menu screen in step 1. See “General Setup” (page 27).

Steering wheel Setting

Set this item when Apple CarPlay is used/Android smartphone which installed Android Auto App is connected. This setting influences Apple CarPlay/Android Auto mode.

Setting item:

Steering wheel

Setting contents:

Left (Initial setting) / Right

Installation Setup

Vehicle Setup enables you to check the connection status of Reverse Lead/Parking Brake Lead.

Setting item:

Installation Status

The Installation check screen is displayed.



Sources Setup

[Sources] is selected on the Setup main screen in step 3. See “Setup Operation” (page 24).

Sources Setup Menu screen



<Setting items>

Radio
PI Seek
RDS Regional
PTY Language
PTY31
FM Tuner Setting
DAB
Alarm
Announcement Mode
FM Linking
DAB Antenna Power
AUX*1
AUX Name*2
Signal*2
HDMI*3
Apple CarPlay*4

*1 This setting cannot be changed while the AUX source is being selected.

*2 This setting is only available when “AUX” is set to “On” (☑).

*3 This setting cannot be changed while the HDMI source is being selected.

*4 This setting cannot be adjusted when an iPod/iPhone is connected or Apple CarPlay/iPod source is being selected.

The following steps 1 to 3 are common to each “Setting item” of Audio Setup. See each section for details.

- 1 Select the desired item.**
- 2 To switch the setting, touch [⟨], [⟩], [+], [–], or mark the checkboxes “Off” (☐) or “On” (☑).**
 - If “>” appears, there is a further hierarchy. Touch the desired item.
- 3 Touch [X] to return to the main source screen.**
 - To return to the previous List screen, touch [⟪] or [⟩] in the previous page. For details, see “About Basic Operation for List Screen” (page 14).

Radio Setup

[Radio] is selected on the Sources Setup Menu screen in step 1. See "Sources Setup" (page 37).

You can set up the items related to the radio reception sensitivity, etc.



PI SEEK Setting

Setting item:

PI Seek

Setting contents:

Auto / Off (Initial setting)

Receiving RDS Regional (Local) Stations

When Off is selected, the unit automatically keeps receiving the local RDS station.

Setting item:

RDS Regional

Setting contents:

On (Initial setting) / Off

Switching the Display Language of PTY (Programme Type)

Setting item:

PTY Language

Setting contents:

ENG (Initial setting) / GER / FRE / SPA / POR / ITA / DUT / DAN / FIN / NOR / SWE / RUS

ENG:	English
GER:	German
FRE:	French
SPA:	Spanish
POR:	Portuguese
ITA:	Italian
DUT:	Dutch
DAN:	Danish
FIN:	Finnish
NOR:	Norwegian
SWE:	Swedish
RUS:	Russian

Setting PTY31 (Emergency Broadcast) Reception

PTY31 (Emergency Broadcast) reception can be set to On/Off.

Setting item:

PTY31

Setting contents:

On (Initial setting) / Off

- The unit automatically gives priority to an emergency broadcast whenever it begins, and interrupts the programme you are currently listening to when PTY31 is set to "On".
- The unit will show "Alarm" in the display during PTY31 reception.
- This setting works with the Alarm (Emergency Broadcast) of DAB.

Setting the TUNER (FM) Tone Quality (Tuner Condition)

This unit can set your preferred tone quality for FM radio source.

Setting item:

FM Tuner Setting

Setting contents:

Normal (Initial setting) / HiFi / Stable

Normal: Standard setting

HiFi: High-quality setting

Stable: Control noise

- Noise may be more noticeable when HiFi is set, depending on the reception status. In this case, the Normal setting is recommended.

DAB Setting

[DAB] is selected on the Sources setup menu in step 1. Refer to "Sources Setup" (page 37).



Setting Alarm (Emergency Broadcast) Reception

Turn Alarm (Emergency Broadcast) reception On/Off.

Setting item:

Alarm

Setting contents:

Off / On (Initial setting)

- Off: Emergency Broadcasts will not be received.
On: Emergency broadcasts are received regardless of source.

- This setting works with PTY31 (Emergency Broadcast) of RDS.
- When an emergency broadcast is received, the volume level will be automatically changed to the memorised level in the traffic information mode. For details, see "Receiving Traffic Announcement" (page 51).

Setting Announcement Reception

You can select your desired station from 8 announcement types.

If "On" is set, when the selected announcement is received, the unit will switch to the DAB source screen automatically and will receive the broadcast.

Setting item:

Announcement Mode → Transport News / Warning/Service / Area Weather News / Event Announcement / Special Event / Program Information / Sport News / Financial News

Setting contents:

Off (Initial setting) / On

Setting the FM Linking ON/OFF (Service Following)

This unit provides FM Linking function which can switch the source from DAB+/DMB to FM radio when the digital signal is weak.

Setting item:

FM Linking

Setting contents:

Off / On (Initial setting)

- Off: Keep receiving the digital signal, even when the digital signal is weak.
On: If the digital signal is weak, this unit will switch to receive the analogue FM radio signal automatically. When receiving an analogue FM radio signal, the "FM Linking" indicator is displayed.

Setting the DAB Antenna ON/OFF

You can choose whether to supply power to DAB Antenna Connector by this setting. Confirm the type of DAB Antenna (sold separately) before installing the DAB antenna. If an active antenna that needs power supply from this unit is used, set DAB Antenna Power to On; if a passive antenna that does not need power supply from this unit is used, make sure to set DAB Antenna Power to Off, otherwise, a malfunction may occur.

Setting item:

DAB Antenna Power

Setting contents:

Off (Initial setting) / On

- Off: When no DAB Antenna is connected or the connected DAB Antenna does not need power supply from this unit.
On: When the connected DAB Antenna needs power supply from this unit.

- If the "DAB Antenna error." message is displayed on the unit, this setting becomes invalid. For details on what to do if "DAB Antenna error," is displayed, see "If this Message Appears" (page 75).

AUX Setup

[AUX] is selected on the Sources Setup Menu screen in step 1. See “Sources Setup” (page 37).

You can set up the items related to the Auxiliary device.



Setting item:

AUX

Setting contents:

Off / On (Initial setting)

- Off: AUX source is not displayed.
- On: AUX source is displayed.

■ Usable 4-pole mini AV plug

The unit accepts the following 4-pole mini AV plug pin-out:

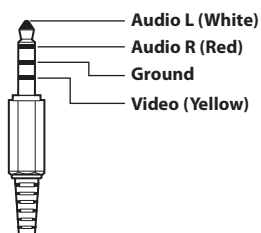

- Please check pin-out carefully before use of this product. Depending on the cable, there may be no picture and/or sound.

Setting the Auxiliary (AUX) Name

Make sure the AUX is set to “On” (☑). See “AUX Setup” (page 40).

Setting item:

AUX Name

Setting contents:

AUX (Initial setting) / AUX DVD / GAME

Switching the Visual Input Signal System

You can make this setting only when AUX is set to “On” (☑). See “AUX Setup” (page 40).

Setting item:

Signal

Setting contents:

Auto (Initial setting) / NTSC/PAL

- Auto: The video input signal type (NTSC or PAL) will be automatically selected.
- NTSC/PAL: Choose the video input signal type manually.

HDMI Setup

[HDMI] is selected on the Sources Setup Menu screen in step 1. See “Sources Setup” (page 37).

You can set the name of an external device connected via HDMI.



Setting item:

HDMI

Setting contents:

HDMI (Initial setting) / DVD

- HDMI: Set when a smartphone is connected via HDMI.
- DVD: Set when an external DVD player is connected.

Apple CarPlay Setup

[Apple CarPlay] is selected on the Sources Setup Menu in step 1. See “Sources Setup” (page 37).

Before connecting an iPhone 5 or later, turn on this item to use the Apple CarPlay function.

Setting item:

Apple CarPlay

Setting contents:

On (Initial setting) / Off

- On: Set before an iPhone 5 or later is connected, the Apple CarPlay can be used, but the iPod source, iHeartRadio and Spotify of Alpine Connect are not available at this time. Alpine Tunelt App is not available normally also.
- Off: Set when you want to use the iPod source, etc., of the connected iPhone 5 or later.

- This setting is invalid for music playing of iPhone 4S and iPod.

System Setup

[System] is selected on the Setup main screen in step 3. See “Setup Operation” (page 24).

■ System Setup Menu screen



<Setting items>

Camera	Camera Select
	Camera Signal*1
	Guide Adjustment*1
	Interrupt (Power OFF)*1
CAN-I/F*2	Default Vehicle Screen
	Climate screen interrupt time
	Parking sensor interrupt
Unit	External AP
Application	Alpine TuneIt App*3

*1 When Camera Select is set to “Off,” you cannot select this item.

*2 CAN-I/F BOX should be connected before this operation.

*3 Set this setting after closing the Alpine TuneIt App.

The following steps 1 to 3 are common to each “Setting item” of System Setup. See each section for details.

- 1 Select the desired item.**
- 2 To switch the setting, touch [<], [>], [+], [-], or mark the checkboxes “Off” () or “On” ().**
 - If “>” appears, there is a further hierarchy. Touch the desired item.
- 3 Touch [X] to return to the main source screen.**
 - To return to the previous List screen, touch [<<] or [<] in the previous page. For details, see “About Basic Operation for List Screen” (page 14).

Camera Setup

[Camera] is selected on the System Setup Menu screen in step 1. See “System Setup” (page 41).

You can set up items related to the Camera.



Setting the Camera Input

Setting item:

Camera Select

Setting contents:

Off (Initial setting) / Rear

Off: No camera is connected
Rear: Rear camera is connected

Setting the Camera Signal Input

When the camera is connected, the video input signal type can be chosen.

Further setting item:

Camera Signal

Setting contents:

NTSC (Initial setting) / PAL

Adjusting the Rear Camera Guide

You can adjust the camera guide position.

Setting item:

Guide Adjustment

- 1 Touch [Guide Adjustment].**
The camera guide adjustment screen is displayed.
- 2 Touch [Adjust].**
 - If [Adjust] does not appear, proceed to step 3.
- 3 Touch the guide you intend to adjust.**
Guide line can also be selected by touching [▼] [▲].

■ Rear Camera screen example

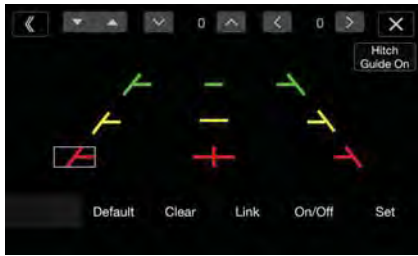

- You cannot adjust the position of the yellow guide line “—” in the centre independently. It is controlled by a system to be the centre of the two yellow guide lines “/” and “\” on the left and right, or the central green line “—” and red guide line “+”.

4 Touch [∨], [∧], [⟨] or [⟩] to adjust the position of the guide.

- Touching [Clear] clears adjustments and returns to the setting before guide line alteration.

5 After the adjustment is completed, touch [Set].

Adjusting Guides Simultaneously

<Rear Camera>

1 Touch [Link].

The 3 vertical guides of the currently-selected guide link together, allowing them to be adjusted simultaneously.



- Note on the yellow guide line “—” in the centre
The yellow guide line “—” in the centre is controlled by a system that locates it in the centre of the two yellow guide lines, “/” and “\” on the left and right, or the green line “—” on the top and red guide line “+” below. Therefore you cannot move it manually.

Turning Guide Display On/Off

Turning the selected guide off.

1 Touch [On/Off].

The currently selected guide will turn off.

2 To turn the guide on, touch [On/Off] again.

- Guides that are turned off are still adjustable.

Returning Guides to Default

1 Touch [Default].

A message window will appear.

2 Touch [OK].

Adjusted values will return to default settings.

Camera Interrupt Setting (Power OFF Mode)

You can set whether to display the rear camera image when the gear lever is moved to the reverse (R) position while the unit is turned off. You can select this item only when Camera Select is “Rear.”

Setting item:

Interrupt (Power OFF)

Setting contents:

On (Initial setting) / Off

On: The rear camera image is displayed

Off: The rear camera image is not displayed

CAN-I/F Setup

[CAN-I/F] is selected on the System Setup Menu screen in step 1. See “System Setup” (page 41).

- CAN-I/F BOX should be connected before this operation.

Setting the Default Vehicle Screen

Touch the Menu screen (page 16) to display the Info mode screen, and then set the following.

Setting item:

Default Vehicle Screen

Setting contents:

Climate / Park sensor / Last mode (Initial setting)

- For details on the Vehicle Info mode screen, see “About Vehicle Interlock Function” (page 72).

Setting the Climate Interrupt Time

You can set the time displayed in the Climate screen.

Setting item:

Climate screen interrupt time

Setting contents:

None / 5 sec (Initial setting) / 10 sec / Continuous display

None: The Climate screen is not displayed when you adjust the air conditioner, etc.

5 sec/10 sec*: The screen is displayed for 5 seconds/10 seconds, then returns to the previous screen.

Continuous display: The Climate screen is continuously displayed.

- * If you set the air conditioner, etc., while the Climate screen is displayed, the screen will continuously be displayed.

- For details, see “About Vehicle Interlock Function” (page 72).

Setting the Parking Sensor Interrupt On/Off

Set to "On" to display the Parking Assist screen if a vehicle detects an obstacle.

Setting item:

Parking sensor interrupt

Setting contents:

Off / On (Initial setting)

- For details, see "About Vehicle Interlock Function" (page 72).

Unit Setup

[Unit] is selected on the System Setup Menu screen in step 1. See "System Setup" (page 41).

Make this setting when you use an external audio processor.

Setting the External AP

When using an external audio processor, set to "On" (☑).

Setting item:

External AP

Setting contents:

Off (Initial setting) / On

- When this setting is "On," the Volume level is fixed at 10. Also, Balance/Fader/Subwoofer Level/Subwoofer Phase/Bass/Treble/MX HD/EQ Presets/Dual HD EQ/X-OVER/Time Correction/Defeat/Phone Speaker/Default Sound Settings are set to "Off" or "Flat" and cannot be adjusted.
- Use the external AP to adjust volume.

Application Setup

[Application] is selected on the System Setup Menu screen in step 1. See "System Setup" (page 41).

Set Alpine TuneIt App to USB (iPhone) when an iPhone is connected, or set to Bluetooth (Android) when an Android Smartphone is paired.

Setting item:

*Alpine TuneIt App*1*

Setting contents:

*Off / USB (iPhone) (Initial setting) / Bluetooth (Android)*2*

Off: No Smartphone is connected.

USB (iPhone): When an iPhone is connected to the unit's USB port, you can programme the unit's sound tuning parameters, or communicate with SNS.

Bluetooth (Android): Set this when an Android Smartphone is paired with this unit via Bluetooth technology. And after Bluetooth Audio is connected, you can programme the unit's sound tuning parameters, or communicate with SNS.

- Set this setting after closing the Alpine TuneIt App.
- For this function to work properly, specific applications must be installed on your Smartphone before connection. Consult your Alpine dealer or the Alpine website for details.
- Only the iPhone and certain Android Smartphones support this function.

*1 Set this setting after closing the Alpine TuneIt App.

*2 Not displayed when Bluetooth is set to Off. For details, see "Bluetooth Setup" (page 25).

Android Auto (Optional)

What is Android Auto

Android Auto is designed to make it easier to use apps from your phone while you're on the road. Navigate with Google Maps, listen to playlists or podcasts from your favourite apps, and more.

Activate Android Auto

Download the Android Auto App from the Google Play store before continuing.

Just plug in your smartphone to the unit's USB connector, then follow the prompt to pair your smartphone with the unit.

- The connected smartphone with Android Auto will disconnect other phone's Bluetooth connection and pair to the unit.

1 Press the  (MENU) button.
The Menu screen is displayed.

2 Touch [Android Auto].

The Android Auto screen is displayed.

- When a used smartphone is reconnected, touch the pop-up message-“Android Auto connected” within 5 seconds to access to Android Auto screen, or you can ignore prompt by touching [X] on the top right.
- You can make a call, use voice recognition function and Android Auto's compatible navigation app, etc.,
- Only Google approved apps with necessary driver-safety measures in place can be used.

Apple CarPlay (Optional)

Apple CarPlay is a smarter, safer way to use your iPhone in the car. Apple CarPlay takes the things you want to do with your iPhone while driving and puts them right on the unit. You can get directions, make calls, send and receive messages, and listen to music, all in a way that allows you to stay focused on the road. Just plug in your iPhone to the unit and go.

- Before using this function, turn Apple CarPlay to On (page 40) and plug in your iPhone using Lightning to USB Cable (Supplied with iPhone) to the unit.
- Some functions may not be available while driving.
- About iPhone models usable with this unit, see “iPod/iPhone (Optional)” (page 56). Only an iPhone 5 or later compatible with Apple CarPlay function.

Access to Apple CarPlay

1 Press the  (MENU) button.
The Menu screen is displayed.

2 Touch [Apple CarPlay].

The Apple CarPlay mode is activated.

Touch the desired App icon on the unit, or use Siri function by pressing  button.

- When a used iPhone 5 or later is reconnected, touch the pop-up message-“Apple CarPlay connected.” within 5 seconds to access to Apple CarPlay screen, or you can ignore prompt by touching [X] on the top right.
- The App must be Apple CarPlay compatible in order to appear in the Home screen.

Radio/RDS

■ RDS (FM1/FM2) main screen example



Function mode



- ① Source Title/Band display
Displays the band of the signal currently being received.
- ② RDS indicator
- ③ Info area
Station Info. Mode: PTY / Frequency or PS / Artist Name / Song Name / Album Name
Radio Text Mode: Frequency / Radio Text
 - For details on switching the display of the Radio text, see "Displaying Radio Text" (page 48).
- ④ Preset mode button
Touch or swipe to the right when you use the Preset mode screen.

■ Preset mode screen example



- ⑤ Preset button
Swipe vertically in the list to change pages.
- ⑥ PTY list button
Swipe to the right when you use the PTY list screen.

■ MW/LW band main screen example



Function mode



- ① Band display
Displays the band of the signal currently being received.
- ② Frequency display
- ③ Preset mode button
Touch or swipe to the right when you use the Preset mode screen.





■ Preset mode screen example













- ④ Preset button
Swipe vertically in the list to change pages.

Radio Basic Operation

Listening to the Radio

- 1 Press the  (MENU) button and select radio mode.**
The display shows the radio mode screen.
 - You can select and change the source from the Favourite screen (page 19).
- 2 Touch .**
The radio band select pop up screen is displayed.
 -  button displays the current selected band. (e.g. [FM1])
- 3 Select the desired band from FM1/FM2/MW/LW.**
- 4 Touch .**
The tuning mode selection popup is displayed.
 -  button displays the current selected mode. (e.g. [DX Seek])
- 5 Touch the desired tuning mode.**
The radio frequency up or down button changes depending on the tuning mode.

DX Seek	Local Seek	Manual
		
PTY	Preset	
		

 - There are two modes you can select for auto tuning, DX and Local:
 - DX Seek (Distance) mode;
Both strong and weak stations will be tuned in.
 - Local Seek mode;
Only strong stations will be tuned in.
The initial setting is DX.
 - Manual mode;
The frequency is manually tuned in steps
 - PTY Seek mode (RDS FM Radio Mode only);
The currently selected programme type station will be tuned.
 - Preset (Preset UP/DN) mode;
You can directly switch preset stations.
- 6 Touch [, ] or [, ] to change the radio frequency up or down respectively.**
In manual mode, touch and hold to change the frequency continuously.
 - The ,  buttons provide the same functions above.

Presetting Stations Manually

- 1 Tune in a desired radio station you wish to store in the preset memory by manual or automatic seek tuning.**
- 2 Touch the Preset number you want to store, for at least 2 seconds.**
The selected station is stored.
- 3 Repeat the procedure to store up to 11 other stations onto the same band.**
To use this procedure for other bands, simply select the desired band and repeat the procedure.
A total of 48 stations can be stored in the preset memory (12 stations for each band; FM1, FM2, MW or LW).
 - For details on switching to the Preset mode screen, see ③ in "MW/LW band main screen example" (page 45).
 - If a preset memory has already been set in the same preset number, it will be cleared and the new station will be memorised.

Presetting Stations Automatically





The tuner can automatically seek and store 12 strong stations in the selected band in ascending order of frequency.

Select the desired band then touch and hold (Auto Memory).

- The tuner automatically seeks and stores 12 strong stations into the preset buttons in ascending order of frequency. When automatic storing has completed, the station stored in the preset 1 is selected.
- If no stations are stored, the tuner will return to the original station you were listening to before the automatic storing procedure began.
 - You can cancel this process by touching  (Auto Memory) while the tuner is automatically seeking stations. Canceling will return the tuner preset to the previous setting.

Tuning to Preset Stations

You can tune in the preset stations in memory on either band using its preset number.

- 1 Touch .**
The radio band select pop up screen is displayed.
 -  button displays the current selected band. (e.g. [FM1])
- 2 Select the desired band from FM1/FM2/MW/LW.**
- 3 Touch any one of the Preset numbers you have already stored in the Preset mode screen.**
The preset station is received.
 - For details on switching to the Preset mode screen, see ③ in "MW/LW band main screen example" (page 45).
 - You can also switch the preset station by touching  or  when the tuning mode of "Preset" is chosen.

Inputting Frequency Directly and Receiving the Radio Station

You can input a frequency of the same band directly and receive the radio station.

- 1 Touch [] (Direct Tune).**
The numeric keypad input mode screen appears.
- 2 Touch a desired number.**

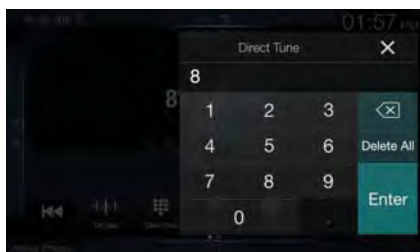

Touch [] to delete an entered number.
Touch [**Delete All**] to delete all entered numbers.

- 3 Touch [Enter] on the numeric keypad mode screen to confirm your selection.**
Touch [] to hide the keypad display.

RDS Operation

Turning AF (Alternative Frequencies) On or Off

The RDS (Radio Data System) is a radio information system using the 57 kHz subcarrier of regular FM broadcasts. The RDS allows you to receive a variety of information such as traffic information, station names, and to automatically re-tune to a stronger transmitter that is broadcasting the same programme.

Touch [] (AF) to select the AF (Alternative Frequency) ON or OFF mode.

In AF ON mode, the "AF" Indicator lights up.

- RDS mode is not be displayed for the MW or LW band.
- When the AF ON mode is selected, the unit automatically tunes to a strong signal station in the AF list.
- Use the AF OFF mode when automatic re-tuning is not required.

Tips

- The RDS digital data includes the following:

PI	Programme Identification
PS	Programme Service Name
AF	List of Alternative Frequencies
TP	Traffic Programme
TA	Traffic Announcement
PTY	Programme Type
EON	Enhanced Other Networks
- Refer to page 38 about "PI SEEK Setting," "Receiving RDS Regional (Local) Stations," "Switching the Display Language of PTY (Programme Type)" and "Setting PTY31 (Emergency Broadcast) Reception."

Interruption Function



If the Interruption Function is enabled, when the following broadcast is received, the unit switches to the Radio source screen automatically, and will receive broadcasts.

- PTY31 (Emergency Broadcast)*1, 2
- TA (Traffic Announcement)*3
- News programme*2

*1 Set PTY31 to "On" in "Setting PTY31 (Emergency Broadcast) Reception" (page 38).

*2 Not interrupted during the DAB broadcast reception.

*3 The Interruption Function for Traffic Announcements works with DAB broadcasts. Therefore, even if the current source is RDS, a Traffic Announcement by DAB broadcast may interrupt.

- "RDS Alarm"/"RDS T.Info"/"RDS News" is displayed in the Band display section during each respective broadcast reception.
- To cancel the Interruption function, touch the RDS main screen or press  (MENU)//  buttons.
- When the interruption broadcast is over, the unit returns to the previous screen.
- Does not interrupt during Hands-free phone talk. During camera image display, only the sound may be interrupted.
- The volume level will be memorised if the volume is adjusted during interruption broadcast reception. When an interruption broadcast is received the next time, the volume level is automatically adjusted to the memorised level.

Receiving Traffic Announcement

Touch [] (TA).

The "TA" indicator lights up and the unit switches to standby mode for the traffic announcement.

When the traffic announcement is received, the "TP" indicator lights up and the unit switches to the radio source screen to receive it.

- The "TP" indicator lights up during standby mode off in a condition other than radio source to indicate that the unit is receiving the traffic announcement.
- If the traffic announcement broadcast signal falls below a certain level, the unit remains in the receiving mode for 1 minute. If the signal remains below a certain level for over 70 seconds, "TA" will blink in the display.

News Programme Interruption

Touch [] (News).

The "NEWS" indicator lights up and the unit switches to standby mode for the News programme. When the News programme is received, the unit switches to the radio source screen to receive it.

Receiving Traffic Information Manually

1 Touch [] (TA) to turn on the Traffic Information mode.

The "TA" indicator lights up.

2 Touch [or].

Seeks the broadcast station which is broadcasting the traffic information.

- You can seek the traffic information in DX Seek mode or Local Seek mode.

Selecting the Receivable PTY

You can select and receive the currently receivable stations in the PTY list screen.

1 Touch the PTY list button.

The Select PTY list screen is displayed.



- For details on switching to the PTY list screen, see ⑥ in "Preset mode screen example" (page 45).

■ PTY list screen example



2 Select the desired programme type in the PTY list screen.

PTY Seek starts and the receivable programme type is received. If no PTY station is found, "No PTY." will be displayed.

- Touch [] or [] to select the same programme type station as the currently selected programme type after switching the tuning mode to PTY (PTY Seek) mode.

Displaying Radio Text

Text messages from a radio station can be displayed.

1 Tune in a radio station that transmits text messages.

2 Touch [] (Info) in the FM radio mode repeatedly to switch to the desired display.

Station Info.Mode → Radio Text Mode → Station Info.Mode

Station Info. Mode

PTY/Frequency or PS/Artist Name/Song Name/Album Name

Radio Text Mode

Frequency/Radio Text

DAB/DAB+/DMB

DAB main screen example



Function mode



- ① Source Title/Announcement
- ② DAB indicator (Signal Strength/Service Component/FM Linking)
- ③ Info area
 - Station Info Mode
 - Frequency, Channel No./Ensemble Label/Service Label/PTY Name
 - Dynamic Label Mode
 - Dynamic Label (Displaying the information related to the current receiving station)
 - For details on switching the display, see "Displaying DAB Text" (page 52).
- ④ Slide Show
 - Displays the program information, artist photos, and advertisements that are synchronised with the Service component currently being received.*
 - You can change the artwork position. For details, see "Switching the Artwork Position" (page 35).
- ⑤ Preset mode button
 - Touch or swipe to the right when you use the Preset mode screen.

* They may not be displayed, depending on the Service component currently being received.

Preset mode screen example



- ⑥ Preset button
 - Swipe vertically in the list to change pages.
- ⑦ Full Search mode button (All Service list, Current Ensemble list or PTY list is displayed)
 - Swipe to the right when you use the Full Search mode screen.

- Confirm the type of DAB antenna (sold separately) before using the DAB/DAB+/DMB function. If an active antenna that needs power supply from this unit is used, set DAB Antenna Power to On; if a passive antenna that does not need power supply from this unit is used, make sure to set DAB Antenna Power to Off; otherwise, a malfunction may occur. See "Setting the DAB Antenna ON/OFF" (page 39).
- When FM Linking is set to On, if the digital signal is weak, this unit will switch to receive the analogue FM radio signal automatically and the source icon for Radio displays as FM Linking. For details, see "Setting the FM Linking ON/OFF (Service Following)" (page 39).
- This product does only support the "Receiver Profile 1 - Standard Audio Receiver" according to the official classification of WorldDMB Forum.

Listening to DAB/DAB+/DMB

- 1 Press the (MENU) button and select DAB mode. The display shows the DAB mode screen.

- You can select and change the source from the Menu screen (page 16) or the Favourite screen (page 19).

- 2 Touch .

The tuning mode selection popup is displayed.

- button displays the current selected mode. (e.g. [Ensemble Seek])

- 3 Touch the desired tuning mode.



- Ensemble Seek mode; Receivable ensembles will be tuned in automatically.
- Ensemble Manual mode; Each ensemble is tuned in one step at a time manually.
- PTY Seek mode; Service (Primary Component) of the selected PTY will be tuned in.
- Service (Service Up/Down) mode; Service Components in the All Service list will be switched.
- Preset (Preset UP/DN) mode; The Preset station will be tuned in directly.

4 Touch [◀]/[▶], [◀◀]/[▶▶] or [◀◀]/[▶▶] to change the Service or Ensemble up or down respectively.

Touch and hold to change the Service or Ensemble continuously.

- The ◀◀, ▶▶ buttons provide the same functions above.

Presetting Service

1 Select the band and ensemble, and then tune in a desired service you wish to store in the preset memory.

2 Touch the preset number you want to store, for at least 2 seconds.

The selected station is stored.

The display shows the service label or channel number memorised.

3 Repeat the procedure to store up to 17 other stations onto the same band.

To use this procedure for other bands, simply select the desired band and repeat the procedure.

- A total of 18 services can be stored in the preset memory.
- If you store a service in a preset memory which already has a service, the current service will be cleared and replaced with the new service.
- For details on switching to the Preset mode screen, see ⑤ in “DAB main screen example” (page 49).

Tuning to Preset Service

You can tune in the preset stations in memory on either band using its preset number.

Touch any one of the preset buttons that has a service stored to it.

The preset service is received.

- For details on switching to the Preset mode screen, see ⑤ in “DAB main screen example” (page 49).

Service Component/PTY Search Function

You can select your favourite Service Component from the All Service list, Current Ensemble Service list or PTY Search list.

Service Search Function

1 Touch [Q] (Search).

- You can also touch the ⑦ Full Search mode button in the Preset mode screen or swipe to the right to display.

2 Touch [≡_{ALL}] (All) or [≡] (Current Ensemble).

The All Service list or Current Ensemble list in the Full Search mode screen is displayed.

ALL: All the currently available Service Component (Primary/Secondary) lists are displayed.

Current Ensemble: Selectable Service Component (Primary/Secondary) lists from the Ensemble currently being received are displayed.

3 Touch the desired Service component.

The Selected service component is received.

- A Secondary Service list that was derived from the Primary Services is displayed in the Service Component list.
- The TP indicator is displayed in the Service Component (Primary) list currently being received.
- The PTY is displayed in the Service Component (Primary) list currently being received.
- You can also narrow down the options and search the Service name using the alphabet search function. (Primary Component only) For details, see “Alphabet Search Function” (page 58).

PTY Search Function

1 Touch [≡_Q] (PTY Search).

A programme type list that was derived from the Primary Services currently being received as Service components is displayed.

- You can also touch the ⑦ Full Search mode button in the Preset mode screen or swipe to the right to display.
- When the All Service list or Current Ensemble list screen is being displayed, touch [Q] (PTY).

2 Touch the desired programme type.

The Service Component list that corresponds with the selected programme type is displayed.

3 Touch the desired Service Component.

The selected Service Component is received.

List Update Function

You can update each list while it is being displayed.

Touch [↻] (List Update).

The list is updated to the currently available list.

Interruption Function

If Interruption Function is enabled, when the following broadcast is received, the unit switches to the DAB source screen automatically, and will receive broadcasts.



- Alarm (Emergency Broadcast)*1,2
- TA(Traffic Announcement)*4
- Announcement*2,3
- News Announcement*2

*1 Set Alarm to "On" in "Setting Alarm (Emergency Broadcast) Reception" (page 39).

*2 Not interrupted during the RDS broadcast reception.

*3 Select the Announcement type received in "Setting Announcement Reception" (page 39), then set the Announcement setting to "On."

*4 The Interruption Function for Traffic Announcements works with RDS broadcasts. Therefore, even if the current source is DAB, a Traffic Announcement by RDS broadcast may interrupt.

- "DAB Alarm"/"DAB T.Info"/"DAB News" is displayed respectively on the Source title section during each broadcast reception. The display differs during announcement reception depending on the announcement type set in "Setting Announcement Reception" (page 39).
- To cancel the Interruption function, touch the DAB main screen or press  (MENU)// buttons.
- When the interruption broadcast is over, the unit returns to the previous screen.
- Does not interrupted during Hands-free phone talk. During camera image display, only the sound may be interrupted.
- The volume level will be memorised if the volume is adjusted during interruption broadcast reception. When an interruption broadcast is received the next time, the volume level is automatically adjusted to the memorised level.

Receiving Traffic Announcement

Touch  (TA).

The "TA" indicator lights up and the unit switches to standby mode for the traffic announcement.

When the traffic announcement is received, the "TP" indicator lights up and the unit switches to the DAB source screen to receive it.

- The "TP" indicator lights up during standby mode off in a condition other than the DAB source to indicate that the unit is receiving the traffic announcement.
- This setting works interlocked with the traffic announcement (Emergency Broadcast) of RDS.

News Programme Interruption

Touch  (News).

The "NEWS" indicator lights up and the unit switches to standby mode for the News announcement.

When the News announcement is received, the unit switches to the DAB source screen to receive it.

- This setting works interlocked with the News announcement (Emergency Broadcast) of RDS.

Inputting Channel Number Directly and Receiving the Broadcasts

You can receive your desired station by inputting the channel number directly.

1 Touch (Direct Tune).

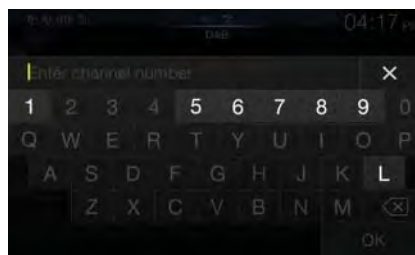

The numeric keypad input mode screen appears.

2 Input the desired channel number.



You can enter channel numbers of up to three digits.

Each time you enter a number, receivable channels will be narrowed down.

- Touch  to delete an entered number. To delete all the numbers you have entered, touch  for at least 2 seconds.



3 Touch [OK].

Switching to Secondary Service Components

When the current Service Component includes Secondary Service components, the Function mode switch  (Sub.Ch) becomes available.

Touch  (Sub.Ch).

The Primary indicator switches to the Secondary indicator, and the Secondary Service Component is received.

- When the Secondary Service Component finishes, the unit automatically switches to the Primary Service Component.
- Touch  (Sub.Ch) again to switch to the Primary Service Component while receiving the Secondary Service Component.
- If there are more than one Secondary Service Component, each time you touch  (Sub.Ch) the indicator changes in the order of Secondary1 → Secondary2 ... → Primary.

Displaying DAB Text

Text messages from a DAB station can be displayed.

- 1 Tune in a DAB station that transmits text messages.**
- 2 Touch [?] (Info) in the DAB mode repeatedly to switch to the desired display.**

Station Info Mode → Dynamic Label Mode → Station Info Mode

Station Info Mode

Frequency, Channel No./Ensemble Label/Service Label/PTY Name

Dynamic Label Mode

Dynamic Label (Displays the information related to the current receiving station)

About DAB/DAB+/DMB

What is DAB?

DAB (Digital Audio Broadcasting) is the third generation broadcasting technology following the traditional analogue technologies such as FM. The advantages of DAB include being more robust with regard to noise, interference, instability, etc., during radio signal transmission. Also, it can provide stereo CD-quality sound and digital information, and it can resist multipath interference guaranteeing high-quality reception for fixed, portable and mobile devices.

What is DAB+?

WorldDMB, the organisation in charge of the DAB standards, announced DAB+, a major upgrade to the DAB standard in 2006, when the HE-AAC v2 audio codec (also known as eAAC+) was adopted. The new standard, which is called DAB+, has also adopted the MPEG Surround audio format and stronger error correction coding in the form of Reed-Solomon coding. DAB+ has been standardised as ETSI TS 102 563.

What is DMB?

DMB (Digital Multimedia Broadcasting) is a future-orientated, new generation broadcasting system based on DAB (Digital Audio Broadcasting). Where DAB upgraded the traditional analogue sound of FM to a CD-quality level, DMB advances simple sound broadcasting to the multimedia arena, striving to provide a visual service while transmitting high-quality sound. Users include entertainment programmes, intellectual traffic navigation, electronic newspapers and magazines, information provided by financial markets, the Internet, and integrated city information. It can be widely used by mobile carriers such as buses, taxis, light railways, underground railways, trains, ferries, airports, and by all kinds of people in the home and office.

USB Flash drive (Optional)

You can play back music files (MP3/WMA/AAC/FLAC) and video files (AVI/MKV/MP4) stored in a USB flash drive on the internal player of this system.

⚠ WARNING

It is dangerous (and illegal in many states) for the driver to watch video while driving the vehicle. The driver may be distracted from looking ahead and an accident could occur.

Install the unit correctly so that the driver cannot watch video unless the car is stopped and the parking brake is applied.

If the unit is not installed correctly, the driver will be able to watch video while driving and may be distracted from looking ahead and cause an accident. The driver or other people could be severely injured.

■ USB Audio main screen example



Function mode



■ USB Video main screen example



- ① Artwork display
 - You can change the artwork position. For details, see "Switching the Artwork Position" (page 35).
- ② Current track no./Total song no.
- ③ Artist title
- ④ Song title
- ⑤ Album title
- ⑥ Elapsed time
- ⑦ Info mode switching button
- ⑧ Info mode display
- ⑨ File Name
- ⑩ Quick Search button
Touch or swipe to the right to use the Quick Search mode.

■ Quick Search mode screen example

Swipe vertically in the list to change pages.



- ⑪ Full Search mode button
Swipe to the right when you use the Full Search mode screen.

The USB Video operation screen display during video file playback

Touch the screen while the USB Video playback screen is displayed.

The USB Video operation screen is displayed.

- The operation screen changes to the visual screen in the USB Video mode for 5 seconds after an operation has been performed.
- For your safety, video is not displayed and only audio can be heard while driving.

Playback

1 Press the (MENU) button and select USB mode.

The display shows the USB mode screen.

- You can select and change the source in the Favourite screen (page 19).

2 Touch [] or [] or to select the desired track (file).

Returning to the beginning of the current (or previous) track (file):

Touch [].

Fast reverse*:

Touch and hold [].

Advancing to the beginning of the next track (file):

Touch [].

Fast forward*:

Touch and hold [].

- The ,  buttons provide the same functions above.

3 To pause playback, touch [/II].

Touching [/II] again will resume playback.

During playback, the [] indicator is displayed in Audio main screen. During a pause, the [II] indicator is displayed in the Audio main screen.

* For details on Fast-forwarding/Fast-reversing during USB video playback, see "Fast-forwarding/Fast-reversing (USB Video only)" (page 54).

- The playback time may not be correctly displayed when a VBR (Variable Bit Rate) recorded file is played back.
- If there is tag information, artist name/album name/track name is displayed.
- ID3 tag/WMA tag
If an MP3/WMA/AAC/FLAC file contains ID3 tag/WMA tag information, the ID3 tag/WMA tag information is displayed. (e.g., song name, artist name, and album name)

Fast-forwarding/Fast-reversing (USB Video only)

1 During playback, touch and hold [] (Fast-reverse) or touch and hold [] (Fast-forward).

Touch and hold for more than 1 second to forward/reverse at 8x speed. Keep touching to switch the speed to 16x and 32x.

2 Release [] or [] to return to normal playback.

- No sound is played back during fast-forwarding/fast-reversing.

Stopping Playback (USB Video only)

Touch [] during playback.

"STOP" indicator is displayed, and playback stops.

- Playback starts from the beginning when [/II] is touched while playback is stopped.

Repeat Play

1 Touch [].

The Repeat mode select pop up screen is displayed.

- The [] button displays the currently selected mode.

2 Select your desired Repeat mode.

Folder : Only files in a folder are repeatedly played back.

File : Only the file currently playing is repeatedly played back.

OFF : Repeat mode Off.

Random Play (USB Audio only)

1 Touch [].

The Random Play mode select pop up screen is displayed.

- The [] button displays the currently selected mode.

2 Select your desired Random Play mode.

ALL : All songs in the USB flash drive are played back in random sequence. Any one song does not play back again until all songs have been played back.

Folder : A Folder is selected randomly and songs in the Folder are played back in order. After all songs are played in a Folder, the next Folder is selected randomly.

File : Only files in a folder are played back in random sequence.

OFF : Random mode Off.

- If you select a track by using the search mode, the Random Play mode will be cancelled.

Searching for a Desired Song

You can search for your desired song by using one of two modes; the Quick Search mode and the Full Search mode.

Quick Search mode

Touch your desired Folder name or File name.

The selected Folder*¹ or File is played.

*1 The first file in the selected folder is played back.

- For details on switching to the Quick Search mode, see ⑩ in "USB Audio main screen example" (page 53).

Full Search mode

1 Touch [Audio] or [Video] to switch whether the search list displays music files or video files.

2 Touch your desired Folder name*² or File name.

When you select a File name, the selected song is played.

When you select a Folder name, repeat the same procedure to select another Folder name or File name.

*2 When you touch the [▶] by a Folder name, the unit plays from the first song in the Folder.

- For details on switching to the Full Search mode, see ⑪ in "Quick Search mode screen example" (page 53).
- To switch the displayed list or return to the previous page in the Full Search mode, see "About Basic Operation for List Screen" (page 14).

Switching Display Modes (During Video File Play Back)

You can switch the Display Mode while playing a Video File.

Touch [].

Each time you touch, the Display Mode is switched.

Fit → Fill → Fit

- The [] button displays the currently selected mode. (e.g. [Fit])
- You cannot operate them while driving.

Fit mode



The mode displays a picture while holding its aspect ratio.

- Black bands appear at the top/bottom or right/left side of the screen depending on the picture.

Fill mode



The mode displays a picture to fit its size vertically and horizontally with the monitor size.

About USB Video format

The video formats (USB Flash drive) supported by the unit are as follows.

- Supported Container: AVI, MKV, MP4
- Supported Video Coding: H.264/MPEG-4 AVC
- Supported Audio Coding: MP3, ACC, MPEG2 audio
- MAX File Size: 4GB

iPod/iPhone (Optional)

A separately sold Lightning to USB cable (KCU-471i), etc., is required. When the unit is connected by the above cable, the controls on the iPod are disabled.

- This unit does not support video playback from iPod/iPhone which connected to this unit via USB Connector.
- Internet or telephone functions, etc., of the iPhone or iPod touch are not controllable from the unit, but these functions can be controlled using the iPhone or iPod touch itself.
- Before an iPhone 5 or later is connected, turn Apple CarPlay to Off, then play iPod music. (page 40)

About iPod/iPhone models usable with this unit

- The following devices have been tested and shown to work with this unit. Correct function of earlier versions cannot be guaranteed.
 - iPod touch 6th generation: Ver.10.1.1
 - iPod touch 5th generation: Ver.9.3.5
 - iPod nano 7th generation: Ver.1.0.4
- The following devices have been tested and shown to work with this unit. Correct function of earlier versions cannot be guaranteed.
 - iPhone SE: Ver.10.1.1
 - iPhone 6S Plus: Ver.10.1.1
 - iPhone 6S: Ver.10.1.1
 - iPhone 6 Plus: Ver.10.1.1
 - iPhone 6: Ver.10.1.1
 - iPhone 5S: Ver.10.1.1
 - iPhone 5C: Ver.10.1.1
 - iPhone 5: Ver.10.1.1
 - iPhone 4S: Ver.9.3.5

■ iPod/iPhone main screen example

Audio mode

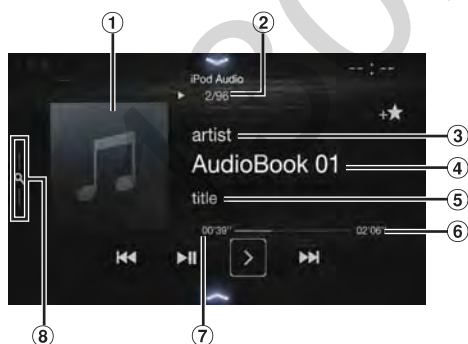

Function mode



- ① Artwork display
 - You can change the artwork position. For details, see "Switching the Artwork Position" (page 35).
- ② Current song no./Total song no.
- ③ Artist title/Release Date*1
- ④ Song title/Episode title*1
- ⑤ Album title/Podcast title*1
- ⑥ Total time for playing
- ⑦ Elapsed time
- ⑧ Quick Search button*2
 - Touch or swipe to the right when using Quick Search mode.

*1 Podcast mode.

*2 If you have never used Search mode with the currently connected iPod/iPhone, pressing the Quick Search button switches the screen to the Full Search mode screen.

■ Quick Search mode screen example

Swipe vertically in the list to change pages.

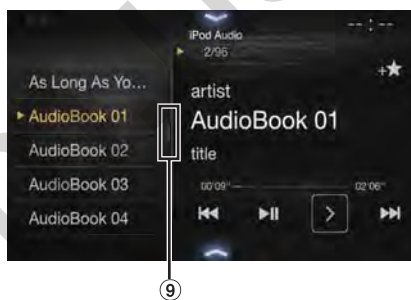

- ⑨ Full Search button
 - Swipe to the right when using Full Search mode.

Playback

1 Press the (MENU) button and select iPod mode.

The display shows the iPod mode screen.

- You can select and change the source in the Favourite screen (page 19).

2 Touch [] or [] or to select the desired track (file).

Returning to the beginning of the current (or previous) track (file):

Touch [].

Fast reverse the current track :

Touch and hold [].

Advancing to the beginning of the next track (file) :



Touch [].

Fast forward the current track :

Touch and hold [].

- The ,  buttons provide the same functions above.

3 To pause playback, touch [/II].

- If a song is playing on the iPod/iPhone before it is connected to the unit, it will continue playing when it is connected.
- An episode may have several chapters. The chapter can be changed by touching [] or [].
- If the artist, album or song name, created in iTunes, has too many characters, songs may not be played back when connected to the unit. Therefore, a maximum of 64 characters is recommended. The maximum number of characters for the unit is 64.
- Some characters may not be correctly displayed.

Searching for a Music File

An iPod/iPhone can contain thousands of songs. For this reason, this unit can make various searches using the search function as shown below.

Using the Playlist/Artist/Album/Podcast/Audiobook/Genre/Composer/Song/iTunes Radio search mode's individual hierarchy, you can narrow down your search as shown in the table below.

<MUSIC Search Menu>

Hierarchy 1	Hierarchy 2	Hierarchy 3	Hierarchy 4
Playlists	Songs	—	—
Artists	Albums	Songs	—
Albums	Songs	—	—
Songs	—	—	—
Podcasts	Episodes	—	—
Genres	Artists	Albums	Songs
Composers	Albums	Songs	—
Audiobooks	—	—	—
iTunes Radio	—	—	—

Quick Search Mode

In Quick Search mode, the list from the previous search mode is displayed. For example, if the last time you searched for songs was in Albums, the Album list is displayed. If you have not used the search mode, the list is not displayed in the Quick Search mode. In this case, go to the Full Search mode.

In Quick Search mode, touch the desired list (for example, Album list).

The selected Album is played.

- To switch into Quick Search mode, see ⑧ in "iPod/iPhone main screen example" (page 56).
- To search within an Album, go to the Full Search mode.

Full Search Mode

For example: Searching by Artist name

The following example explains how an Artists search is performed.

Another search mode can be used for the same operation, although the hierarchy differs.



1 Touch [Artists] in the Full Search mode screen.

The Artists search screen is displayed.

- To switch into Full Search mode, see ⑨ in "Quick Search mode screen example" (page 56).

2 Select the desired artist.

To play back the Artist directly

- Touch [] of the artist's name.
All songs of the selected artist are played back.

To search for the Album of the Artist

- Touch the selected artist name.
The Albums search screen of the selected artist is displayed.
- Touch [] of the desired album's name.
All songs of the selected album are played back.

To search for a Song in the Album of the Artist

- Touch the desired artist's name.
All albums of the selected artist are displayed.

3 Touch the desired album's name.

All songs of the selected album are displayed.

4 Touch the desired song's name.

The selected song is played back.

- An alphabet skip function is available. See "Alphabet Search Function" (page 58).
- To switch the displayed list or return to the previous page in the Full Search mode, see "About Basic Operation for List Screen" (page 14).

Alphabet Search Function

The unit is provided with an alphabet search function for effective searching. When you use this function in the search mode, you can quickly search an artist or a song, etc.

This is an example of how to search Artist Name for names beginning with "R".

1 Touch "O-U" of the alphabet group.



"O P Q R S T U" of the alphabet group "O - U" is displayed.

2 Touch "R" you want to search.

Artist names beginning with "R" are displayed.



3 Touch your desired artist name.

- If there are no names in the list beginning with that letter, the next letter of the alphabet is searched.
For example: If there are no names beginning with "R," the search list begins with "S."

Repeat Play

Touch [↺] to repeatedly play back the currently track.

The tracks (files) will be played repeatedly.

Touch [↻] again to deactivate Repeat play.

Repeat All → Track Repeat ↺ → OFF ↻ → Repeat All

Random Play (Shuffle)

1 Touch [↻].

The Random Play mode select pop up screen is displayed.

- The [↻] button displays the currently selected mode.

2 Select your desired Random Play mode.

The selected Random Play mode changes the button.

- Album ↻: The songs on each album are played back in proper order. Upon completing of all the songs on the album, the next album is selected randomly. This continues until all albums have been played.
- Songs ↻: Song shuffle randomly plays back songs within a selected category (playlist, album, etc.). The songs within the category are played just once until all songs have been played.
- OFF ↻: Random mode Off.

- The action depends on the connected iPod.

HDMI Device (Optional)

Devices supporting HDMI can connect and play back through this unit (for example, an optional DVE-5300 (DVD Player), iPhone or other Smartphones). When making HDMI connections, you need to set HDMI on the unit suitable for the connected device. For details, see "HDMI Setup" (page 40).

- The HDMI/MHL connecting cable differs depending on the connected device corresponding to HDMI. Prepare optional HDMI/MHL connecting cable sets suitable for your device.

DVD Player Operation

You can operate discs using the Remote Control unit supplied with the DVE-5300 (DVD Player). For details on operating the Remote Control unit, refer to the Owner's Manual of the DVE-5300.

Press the  (MENU) button and select DVD (CD) mode.

The display shows the DVD (CD) mode screen.

- For details on the types of playable discs and formats, refer to the Owner's Manual of the DVE-5300.

The DVD operation screen display

Touch the screen while the DVD playback screen is displayed.



- The operation screen changes to the visual screen in the DVD mode for 5 seconds after an operation has been performed.
- If you try to activate the DVD while driving, the display will show the warning-Picture off for your safety.

HDMI Operation

■ iPhone, Smartphone, etc.

The output of your electronic device will be mirrored on this unit through the HDMI connector. Control from this unit is not possible.

- The electronic device must possess an HDMI output interface.
- Not all devices with an HDMI output interface can be recognised by this unit.
- Use only the Alpine Special HDMI connection cable.

1 Press the  (MENU) button and select HDMI mode.
The display shows the HDMI mode screen.

- You can select and change the source in the Favourite screen (page 19).
- For your safety, video is not displayed and only audio can be heard while driving.

2 In HDMI player mode, the screen of the device displays the content of electronic equipment by mirror image.

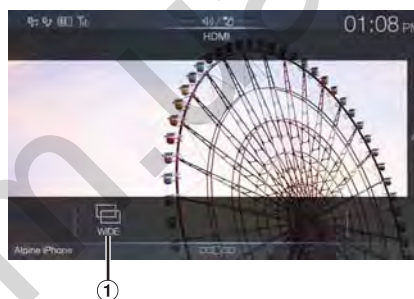

① You can select Display Mode.
For details, see "Switching Display Modes (During Video File Play Back)" (page 55).

- You cannot operate them while driving.

Bluetooth Operation

Setup Before Using

About Bluetooth

Bluetooth is a wireless technology allowing communication between a mobile device or personal computer over short distances. This enables a hands-free call or data transmission between Bluetooth compatible devices. Bluetooth transmission is available in the unlicensed 2.4 GHz spectrum if the distance between devices is within 10 metres. For details, refer to the Bluetooth website (<http://www.bluetooth.com/>).

- Depending on the Bluetooth version, a Bluetooth compatible device may not be able to communicate with this unit.
- Proper function of this unit with all Bluetooth compatible devices is not guaranteed. For handling of the Bluetooth compatible device, consult your Alpine dealer or Alpine website.
- Depending on the surroundings, Bluetooth wireless connection may be unstable.
- When you place a call, or perform setup operations, be sure to stop your car in a safe place.
- Depending on the connected Bluetooth compatible device(s), the function may differ. Also refer to the Owner's Manual of the connected device(s).

About the Hands-free Phone

Hands-free calls are possible when using a HFP (Hands-Free Profile) compatible mobile phone with this unit.

- Avoid performing a hands-free call in heavy traffic or on narrow or winding streets.
- Close the windows while calling to reduce background noise.
- If both calling parties are using hands-free devices, or the call is made in a noisy location, difficulty hearing the other person's voice is normal.
- Depending on telephone line conditions or certain mobile devices used, voices may sound unnatural.
- When using a microphone, speak as directly as you can into the microphone to obtain the best sound quality.
- Certain mobile phone features are dependent on the capabilities and settings of your service provider's network. Additionally, certain features may not be activated by your service provider, and/or the provider's network settings may limit the feature's functionality. Always contact your service provider about feature availability and functionality. Alpine reserves the right to change or modify any information or specifications without notice or obligation.
- Notice that when you connect an iPhone 5 or later/Android smartphone which installed Android Auto App, the operation screen may differ from this section.

Before Using Bluetooth

Before using the hands-free phone/audio function, the following settings need to be made.

- 1 Set "Bluetooth" to "On" (☑).
- 2 Register a Bluetooth device in this unit (page 25).
 - See "Bluetooth Setup" (page 25).
 - You can search for this unit using a Bluetooth compatible device, and then connect that Bluetooth compatible device to this unit. The unit name "iLX-F903D", is displayed on your phone and the initial number of the passcode is "0000." Also refer to the Owner's Manual of the connected device(s).

Hands-free Phone Control

Touch [Phone] in the Menu screen to display the Phone menu screen (page 60).



[Phone] button

Phone menu screen example



- ① Recent Events list*
You can display up to 60 items, such as phone numbers of the most recent incoming calls, missed calls and outgoing calls, and contact names that are registered in the Phone Book. When 60 items exist in the list, the oldest item is deleted when a further item is to be added.
- ② Contacts list*
You can make a phone call from the Phone Book, or edit the Phone book.
- ③ Keypad screen
Use to type a phone number.
- ④ Edit*
Use to edit the Contacts list.

* When you connect two Hands-Free Phones, the information of the Bluetooth device set to Primary is displayed.

Answering a Call

Incoming calls are announced by the received call ring tone and a displayed message (PHONE No., etc.).

- 1 An incoming call triggers the ringtone and an incoming call display.

Incoming call notification screen

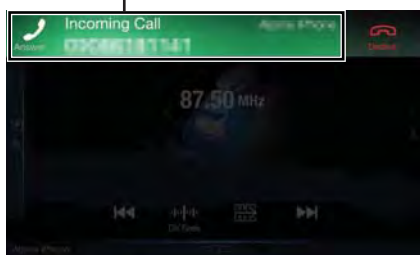

- 2 Touch incoming call notification screen. The call starts.

Call info area

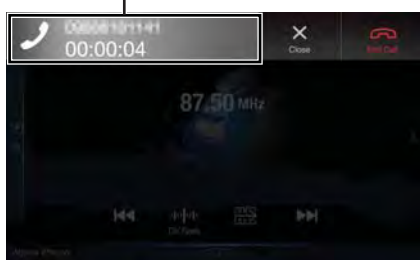

- During a call, the audio for the current mode on the unit is muted. After calling, playback will resume.
- When the caller's number is transmitted to the system, if the caller's name is stored in the phone book, the name is displayed. If the name is not stored, the number is displayed. When neither the name or the number is unavailable, "Unknown" is displayed.
- Touch [📞] (Decline) to reject an incoming call.
- Touch the call info area during a phone call to switch to the Phone Operation screen. Then you can adjust the speech volume, etc. For details, see "Operations During a Conversation" (page 64).
- Touch [X] during a conversation to hide the call info area. To display it again, Touch or swipe downward on [📞] on the upper part of the screen.
- During an incoming call or a conversation on the Primary (Secondary) Hands-Free Phone, if there is an incoming call on the Secondary (Primary) Hands-Free Phone, you cannot answer the call on the Secondary (Primary) Hands-Free Phone without first ending the call on the Primary (Secondary) Hands-Free Phone.

Hanging up the Telephone

- 1 Touch [📞] (End Call). The call finishes.

Call Waiting Function

If a call comes in from another phone during a call, a notice is displayed on the screen. This function can only be used if the connected mobile phone has a call waiting function service included.

Second incoming call during a conversation in the call info area

Second incoming call notification screen

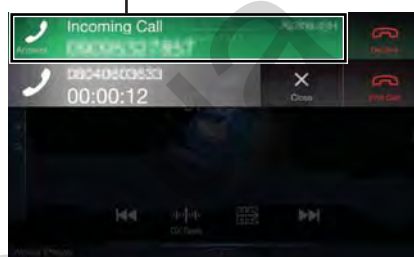

By touching the second incoming call notification screen, you can put the current call on hold and answer the second call.

Call On Hold screen

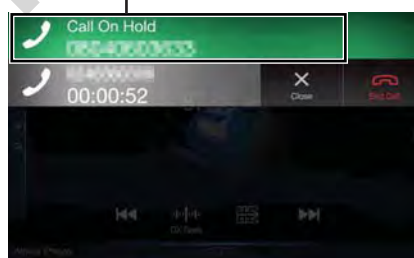

- To switch between calling parties, touch the on-hold screen.
- To finish a call, touch [📞] (End Call).

Second incoming call during a conversation in the Phone Operation screen

- The display or operation may differ depending on the connected mobile phone or the caller's mobile phone.

Second incoming call notification screen

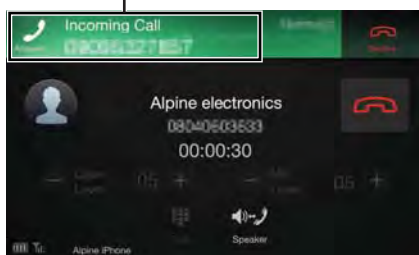

By touching the second incoming call notification screen, you can put the current call on hold and answer the second call.

Call On Hold screen

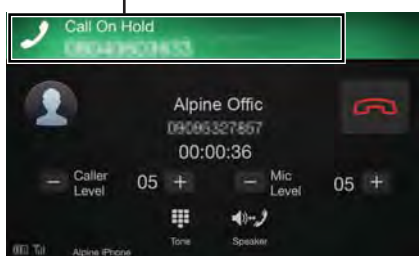

- To switch between calling parties, touch the on-hold screen, or press the **(PHONE)** button.
- To finish a call, touch **(End Call)**.
- This unit supports only the Call Waiting function of a mobile phone. The second call function and three-way calling function of a mobile phone cannot be operated from this unit. Also the screen display may malfunction.

Calling

Calling by Favourite Function

You can make a phone call using the Short Cut function of numbers that have been registered in Favourite. For details, see "Favourite Function" (page 19).

- 1 Press the ★ (Favourite) button.**
The Favourite screen is displayed.
- 2 Touch the Short Cut icon.**
A contact's name, phone number, and a confirmation message of the phone number are displayed.
- 3 Touch [Call].**
The phone call is started.

Making a phone call using the Phone Menu

Making a phone call from the Recent Events list

- 1 Touch [Recent] (Recents) to change to the Recent Events list screen.**



Dialled history:

Names or Numbers/Date

Received history:

Names or Numbers/Date

Missed Incoming history:

Names or Numbers/Date

- 2 Touch the name of the contact you want to call.**
The Detail info screen is displayed.
- 3 Touch [Call].**
The phone call is started.

Calling from the Contacts list (Phone Book)

- 1 Touch [Contacts] (Contacts) to change to the Contacts list screen.**
- 2 Touch the name of the contact you want to call.**
The Phone Operation screen is displayed.

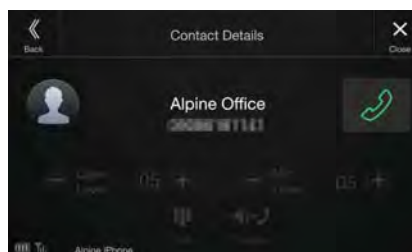

- 3 Touch [Call].**
The phone call is started.

Entering a Phone Number to Make a Call

1 Touch [Keypad].

The number input screen (Keypad) appears.



Touch [X] to delete an entered number.

Touch [Delete All] to delete all entered numbers.

2 Enter the phone number you wish to call.

- You can enter up to 31 digits.

3 Touch [Call].

A confirmation message of the phone number appears.

4 Touch [Call].

The phone call is started.

Using Voice Recognition function

You can use Siri function of your iPhone or make a telephone call by using voice operation of your smartphone.

Using Siri

You can use the Siri function of your iPhone. To use this function, set the Siri setting of your iPhone to ON.

- Connect your iPhone to the unit via Bluetooth, then set to "Hands-free" or "Both" (page 25).
- The available functions differ depending on the connected iPhone.
- Siri and other streaming services are enabled by connecting to compatible smartphones that are able to receive data. Please ensure that cellular data and/or Wi-Fi is turned on in the smartphone to enjoy these features.
- Extensive use of Siri or other streaming services may increase your phone's data usage. Please check with your phone company to ensure you have an appropriate Data plan.

1 Press the microphone button.

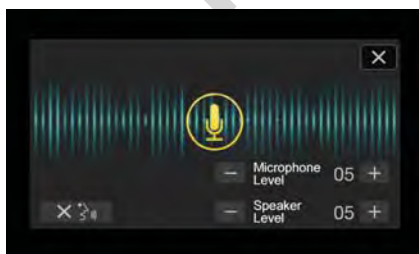

The Voice Control mode screen is displayed.

2 Speak into the microphone supplied with this unit.

- If no speech is detected, the unit may pause depending on version of the connected iPhone. In that case, touch the microphone icon [Microphone] in the centre of the Voice Control mode screen. You can continue to use the Voice Control mode.

3 To finish the Voice Control mode, touch [X] or press the microphone button.

- Depending on the iPhone, the Siri function may finish automatically.

Adjusting the volume

Adjust the speaker/microphone volumes in Voice Control mode.

Perform the same procedure to adjust the speaker/microphone volumes of hands-free phone.

Touch [-] or [+].

Adjust the speaker and microphone volumes.

Stopping input to the microphone

If the surrounding sound (road noise, etc.) is loud, you may wish to cut input to the microphone for 3 seconds.

Touch [X] or [Microphone].

Voice Dial Function

You can make a telephone call by using voice operation.

- Connect your smartphone to the unit via Bluetooth, then set to "Hands-free" or "Both" (page 25).

1 Press the microphone button.

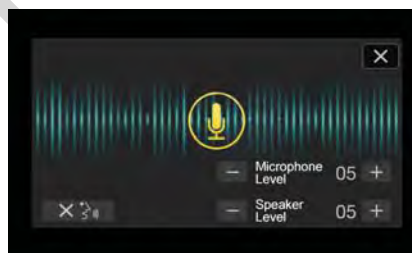

The Voice Dial mode screen is activated.

2 Say the telephone number* or name* you want to call, into the microphone.

- * The number and name depend on the voice dial information stored in the smartphone.

3 To finish the Voice Dial mode, touch [X] or press the microphone button.

- You can perform this operation only when a voice dial compatible smartphone is connected.
- The Voice Dial function performance depends on the recognition range of the smartphone and mounting location of the microphone. Note when the microphone is mounted.
- Voice dial operation depends on the function being available on the smartphone. For details, refer to the owner's manual of the smartphone.
- Depending on the smartphone, the Voice Dial operation may finish automatically.

Adjusting the volume

Adjust the speaker/microphone volume in Voice Dial mode. Perform the same procedure to adjust the speaker/microphone volume of hands-free phone.

Touch [–] or [+].

Adjust the speaker and microphone volumes.

Stopping input to the microphone

If the surrounding sound (road noise, etc.) is loud, you may wish to cut input to the microphone for 3 seconds.

Touch [X] .

Operations During a Conversation

Phone Operation screen

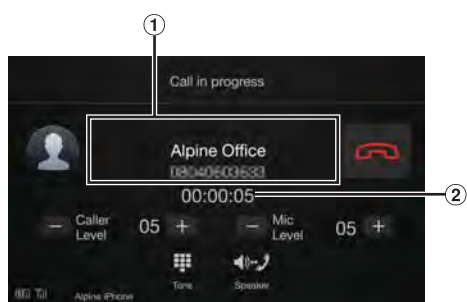

- 1 Name and phone number
 - If registered with a Group, the Group Name is also displayed. Although, depending on the connected mobile phone, it may not be displayed.
- 2 Conversation time

Adjusting the Speech Volume

You can adjust Caller Level and Mic. Level (Microphone Level) during a phone call.

Touch [–] or [+].

You can adjust the volume in 11 levels.

Changing the Voice Output

The voice output for calls is switchable between car speakers and the mobile phone speaker.

Touch [] (Speaker).

- Depending on the mobile phone, this operation may not be possible.

DTMF (Touch-Tone) Function

Transmits a DTMF (Touch-Tone) during a call.

- 1 Touch [] (Tone).
The number input screen (Keypad) appears.
- 2 Input number.
 - You can transmit a Touch-Tone signal during a call.

Phone Book Function

Phone Book screen example

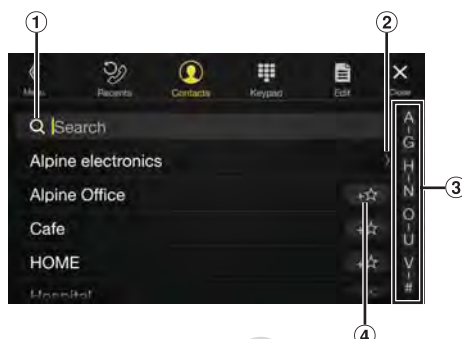

- 1 Use to search by directly inputting a name or phone number with the Keypad.
For details, see "How to Input Characters and Numbers (Keypad)" (page 18).
- 2 Displayed when multiple phone numbers are registered.
Touch [>] to display the registered phone number list.
- 3 Use to narrow down your search for names, etc.
For details, see "Alphabet Search Function" (page 58).
- 4 Touch [+★] to register as Favourite.

Synchronising the Phone Book

You can synchronise the system's phone book with the mobile phone's phone book.

- 1 Touch [] (Edit).
- 2 Touch [Download].
- 3 Touch [SYNC].
Synchronisation of the phone books starts.

- You can store up to 1,000 registered name in the phone book.
- You can store up to 5 phone numbers by one person's name.

Adding the Phone Book

- 1 Touch [] (Edit).
- 2 Touch [Download].
- 3 Touch [Add].
Stays on standby for connection of the mobile phone.
 - Touch [Cancel] to cancel the standby mode.
- 4 The mobile phone accesses this unit and then transfers the phone book from the mobile phone to this unit.
 - Mobile phone connection is cancelled while the phone book is being transferred.

Deleting the Phone Book Entries

Deleting One Entry from the Phone Book

- 1 Touch [Edit].
- 2 Touch the checkbox [] of the contact name (or phone number) you want to delete. A tick [] appears in the checkbox.
 - You can choose up to 10 names and numbers at a time.
- 3 Touch [Delete].
The confirmation screen is displayed.
If multiple phone numbers are registered, they are all deleted.

- 4 Touch [OK].
The selected number is deleted.

Deleting All Entries from the Phone Book

- 1 Touch [Edit].
- 2 Touch [Delete All].
The confirmation screen is displayed.
- 3 Touch [OK].
All entries of the phone book are deleted.

Searching in the Phone Book

You can make a call using the phone book search function.

- 1 Touch [Search].
The Input User Name screen (Keypad) is displayed.
- 2 Input the string of letters of the name that you want to search, then touch [OK].
A list of names beginning with the string of letters you entered is displayed.
- 3 Touch the name you want to call.
The Phone Operation screen is displayed.
- 4 Touch [Call].
The phone call is started.

- For details of how to input characters using the keypad, see "How to Input Characters and Numbers (Keypad)" (page 18).
- If there are fewer than five registered items in the phone book, you cannot use the phone book search function.

Bluetooth Audio

If a Bluetooth compatible mobile phone, portable player, etc. is connected by wireless, you can play back a song (operation is controllable from the unit).

- Operation may vary, depending on the Bluetooth compatible device.

Bluetooth Audio main screen example



Function mode



- ① Current track no./Total song no.
- ② Artist title
- ③ Song title
- ④ Album title
- ⑤ Elapsed time
- ⑥ Touch or swipe to the right to use the Quick Search mode and Full Search mode.

Quick Search mode screen example

Swipe vertically in the list to change pages.



- ⑦ Full Search button
Swipe to the right when using Full Search mode.

- The displayed onscreen buttons may differ depending on the AVRCP version.
- Song title/Artist title/Album title/Elapsed time do not display for AVRCP Ver. 1.0.
- To play back audio, a mobile phone or a portable player conforming to A2DP (Advanced Audio Distribution Profile) or AVRCP (Audio/Video Remote Control Profile) is required.
Not all functions work with all devices.
- During a call, sound on the Bluetooth audio source is paused.

Compatible AVRCP versions: 1.0, 1.3, 1.4, 1.5

- Available functions may differ depending on the AVRCP version.

Playback

1 Press the (MENU) button and select Bluetooth Audio mode.

The display shows the Bluetooth Audio mode screen.

- You can also select and change the source in the Favourite screen (page 19).

2 Touch [] or [] to select the desired track (file).

Returning to the beginning of the current file:

Touch [].

Fast backward the current file:



Touch and hold [].

Advance to the beginning of the next file:

Touch [].

Fast forward the current file:

Touch and hold [].

- The ,  buttons provide the same functions above.

3 To pause playback, touch [/||].

Repeat Play

Available for AVRCP Ver. 1.3, 1.4 and 1.5 only.

1 Touch [].

The Repeat mode select pop up screen is displayed.

- [] displays the currently selected mode.

2 Select your desired Repeat mode.

The selected Repeat mode changes the button.

All Track : Once all of the songs have finished playing, play back is repeated, starting with the first song.

Group : Only files in a group are repeatedly played back.

Single Track : Only the track currently playing is repeatedly played back.

Off : Repeat mode Off.

- Operations may differ depending on the connected Bluetooth compatible device.

Random Play

Available for AVRCP Ver. 1.3, 1.4 and 1.5 only.

1 Touch [].

The Random Play mode select pop up screen is displayed.

- The [] button displays the currently selected mode.

2 Select your desired Random Play mode.

The selected Random Play mode changes the button.

All Track : All songs in the BLUETOOTH compatible devices are played back in random sequence. Any one song does not play back again until all songs have been played back.

Group : A Group is selected randomly and songs in the Group are played back in order. After all songs are played in the Group, the next Group is selected randomly.

Off : Random mode Off.

- Operations may differ depending on the connected Bluetooth compatible device.

Search Function

Available for AVRCP Ver. 1.4 and 1.5 only.

The displayed list differs with the connected Bluetooth device.

You can search for your desired song by using one of two modes; the Quick Search mode and the Full Search mode.

Quick Search mode

Touch your desired Group name or File name.

The selected Group*¹ or file is played back.

*¹ The first file in the selected Group is played back.

- To switch into Quick Search mode, see ⑥ in "Bluetooth Audio main screen example" (page 65).

Full Search mode

Touch your desired Group name*² or File name.

When you select a File name, the selected song is played.

When you select a Group name, repeat the same procedure to select another Group name or File name.

*² When you touch the [] by a Group name, the unit plays from the first song in the Group.

- To switch into Full Search mode, see ⑦ in "Quick Search mode screen example" (page 65).
- To switch the displayed list or return to the previous page in the List screen, see "About Basic Operation for List Screen" (page 14).

Connecting a Bluetooth Device

Registering a Bluetooth device in the unit enables automatic connection. If it does not connect automatically, run through the connection procedure again.

- 1 Touch [📶] (Phone Setting).**
The Device Setting select pop up screen is displayed.
- 2 Touch [Reconnect].**
Bluetooth connection will start.

Disconnecting the Bluetooth Connection

- 1 Touch [📶] (Phone Setting).**
The Device Setting select pop up screen is displayed.
- 2 Touch [Disconnect].**
The Bluetooth connection is disconnected.

Changing the connecting Bluetooth Device

If multiple Bluetooth devices are registered in this device, you can change the connection among the registered devices.

- 1 Touch [📶] (Phone Setting).**
- 2 Touch [Change Phone].**
- 3 Touch [🎵] (Audio) or [📞] (Hands-free) of the selected device.**
The connection will transfer to the selected device.

Auxiliary Device (Optional)

Operating Auxiliary Devices (Optional)

To operate devices connected to the AUX terminals of the unit, follow the procedure described below.

- Set AUX to “On.” See “AUX Setup” (page 40).
- Depending on the connected unit, the onscreen buttons may not work, or their operation may differ.

⚠ WARNING

It is dangerous (and illegal in many states) for the driver to watch video while driving the vehicle. The driver may be distracted from looking ahead and an accident could occur.

Install the unit correctly so that the driver cannot watch video unless the car is stopped and the parking brake is applied.

If the unit is not installed correctly, the driver will be able to watch video while driving and may be distracted from looking ahead and cause an accident. The driver or other people could be severely injured.

Press the  (MENU) button and select Auxiliary (AUX)* mode.

The display shows the Auxiliary (AUX) mode screen.

* The name which is given as the mode name in “Setting the Auxiliary (AUX) Name” (page 40) is displayed.

- For your safety, video is not displayed and only audio can be heard while driving.
- You can select and change the source in the Favourite screen (page 19).
- For details on the connected auxiliary device, refer to its owner’s manual.

AUX Operation Screen Display During Video File Playback

Touch the screen.

The Auxiliary (AUX) operation screen is displayed.

- The operation screen changes to the visual screen in the Auxiliary (AUX) mode for 5 seconds after an operation has been performed. To hide the Auxiliary (AUX) operation screen, touch the video display area.

Operating an AUX, AUX DVD or GAME

■ Example for AUX, AUX DVD, GAME mode display



① (Display Mode)

For details, see “Switching Display Modes (During Video File Playback)” (page 55).

- You cannot operate them while driving.

Camera Operation (Optional)

When an optional rear camera is connected, the view video of camera can be output to the monitor.

Rear camera:

If a rear camera is connected, when the vehicle is reversed, the rear camera view (guide marks for vehicle width and available distance) is displayed automatically on the screen of this unit.

You can adjust the quality of the camera image.
Setting items: Brightness / Colour / Contrast
See "Visual Setup" (page 33).

Rear Camera Operation

Displaying the Rear Camera Image from the Menu screen

- 1 Press the  (MENU) button.
The menu screen is displayed.



[Camera] button

- You can also display the menu screen by touching the lower part of the Audio source screen or by swiping upward.
- 2 Touch [Camera].
The Rear Camera view is displayed.
- Touch the screen while the camera image is being displayed, and touch [X] or [⏪] to return to the main source screen or previous screen.
 - You can perform a Guide Adjustment. For details, see "Adjusting the Rear Camera Guide" (page 41).

Displaying the rear view video while the car is in reverse

- 1 Shift the gear lever to the reverse (R) position.
The rear view image is displayed while the car remains in reverse.
 - 2 If you shift the gear lever to a position other than reverse (R), the monitor returns to the previous screen.
- Never depend solely on the camera when backing up. Always turn and look and only use the camera for additional assistance.
 - This function is effective when the reverse wire is properly connected.
 - You can perform a Guide Adjustment. For details, see "Adjusting the Rear Camera Guide" (page 41).

Guide Display ON/OFF Setting

- 1 Touch the screen when the image from the camera is displayed.
The operation screen is displayed on the screen.
 - After a 5-second time-out, the operation screen returns to the camera display screen.
- 2 Touch [Guide Off] on the Rear camera display screen.
The guide disappears, and then the [Guide Off] switch changes to [Guide On].
- 3 Touch [Guide On] to turn on the guide.

Adjusting the Caution Display Location

- 1 Touch the screen when the image from the camera is displayed.
The operation screen is displayed on the screen.
 - After a 5-second time-out, the operation screen returns to the camera display screen.
- 2 Touch [↕ Caution].
 - For each touch, the caution location moves to the top or bottom of the screen.

About the Rear Camera Guide

To display the guide, set "Guide Display ON/OFF Setting" (page 69) to On. Also, to adjust the guide, see "Adjusting the Rear Camera Guide" (page 41). You can also turn off the guide in the Rear camera display screen.

■ Indication mark meaning

When the car is put into reverse gear, the monitor switches to the rear view camera image. Guides appear to help visualise the car's width and distance from the rear bumper.

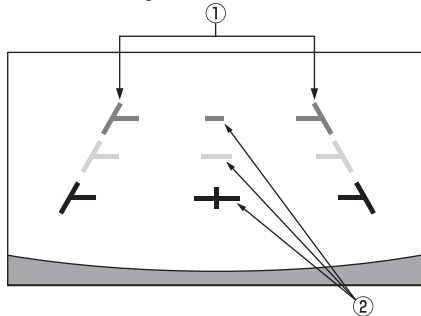

① Car width extension marks (red, yellow and green in order of distance)

If properly calibrated, the marks indicate the car's width. This helps guide the car's path when backing up in a straight line.

The marks represent the distance from the rear of the car (from the rear end of the bumper).

- The marks do not move in synchronisation with the steering wheel.
- Set the marks to suit the car's width.

② Distance guidance marks

The marks represent the distance from the rear of the car (from the rear end of the bumper).

- The marks do not move in synchronisation with the steering wheel.
- We recommend that you measure the actual distance to the marks when parked on a level surface.
- Depending on the condition of the car or road surface, the range of vision may vary.
- The camera has a limited range of vision. Objects at extreme angles to the camera (e.g. under the bumper or at opposite ends of the bumper) may not be in its field-of-vision.
- The rear camera image may have a tint which is different from the actual surroundings.
- Depending on the car, the guidance may deviate to the right or left. This is not a malfunction.

■ Distance guidance mark

The distance guides represent the ground level distance from the rear bumper. It is difficult to accurately estimate the distance to objects above ground level.

In the following example, the distance to A is 0.5 m and the distance to B is 1 m.

<Screen>

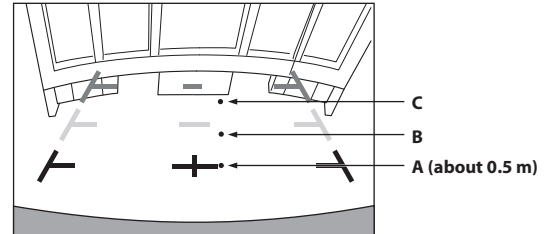

<Positions of A, B and C>

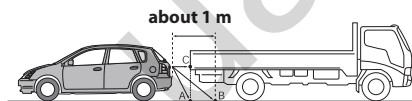

In the screen, according to the distance guidance marks, the truck seems to be parked about 1 m away (at the position B). In actual fact, however, if you reversed to position A, you would collide with the truck.

In the screen, positions A, B and C seem to be located in order of proximity. However, in actual fact, the position A and C are the same distance, and B is farther away than positions A and C.

- The car width extension mark represents the distance to the road surface. The distance to an object on the road is not accurately represented by the guides.

Error between the screen and the actual road surface

In the following conditions, errors are produced between the screen guidance and the actual road surface. (The illustrations represent a case when the camera is installed in the standard position.)

■ When there is a steep upward slope behind the car (example)

<Screen>

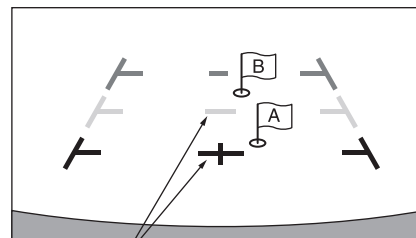

Distance guidance marks

<Situation of the car>

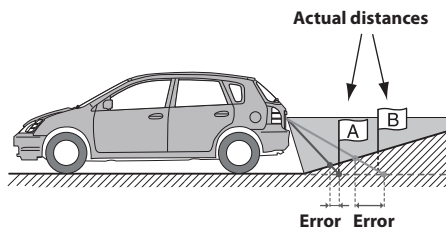

The distance guidance mark represents the distance to a flat road surface. Therefore in the case of an upward slope behind the car, the distance guides are displayed closer to the rear bumper than the actual distance. For example, if there is an obstacle on the upward slope, it may appear farther away than its actual position. Also, an error may occur between the guidance and the actual path of the car on the road surface.

■ When there is a steep downward slope behind the car (example)

<Screen>

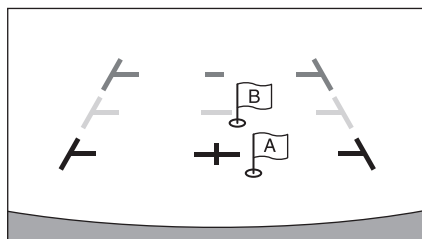

<Situation of the car>

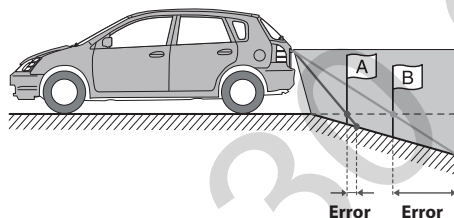

In the case of a downward slope behind the car, the distance guides are displayed farther from the rear bumper than the actual distance. If there is an obstacle on the downward slope, it seems closer than its actual position. Also, an error may occur between the guidance and the actual path of the car on the road surface.

About Vehicle Interlock Function

Communication between your vehicle and the unit allows you to set and display various functions of your vehicle.

Available functions differ depending on your vehicle. For details, refer to your vehicle's instruction manual.

Available Main Functions

- You can check the air conditioner settings on the Climate screen.*
- You can check for obstacles on the Parking Sensor screen.*
- You can adjust various settings for your vehicle from the unit.

* When the Interruption function is set to "On," the screen changes automatically when you adjust the air conditioner or the unit detects an obstacle. For details on the Interruption setup, see "CAN-I/F Setup" (page 42).

Vehicle Info mode

You can check the Climate screen and Park sensor screen from the Menu screen of the unit. For how to display the Menu screen, see "About the Menu Screen" (page 16).

1 Press and hold the ★ (Favourite) button or touch [🚗] (Vehicle Info) on the Menu screen.

The Vehicle Info mode screen is displayed.

2 Touch the desired tab on the upper part of the screen.

The Climate screen or Park sensor screen is displayed.

- By touching [⚙️] (Car Setting) on the Vehicle Info mode screen, you can use the unit to turn various settings related to your vehicle On/Off, set display formats, etc. For details on what functions you can set, refer to your vehicle's instruction manual.

Function Screen Examples

The screens that can be displayed on this unit differ, depending on the type of vehicle.

Climate screen example

The Climate screen turns on when you adjust the air conditioning in your vehicle. The icons of adjusted items are high lighted.



Parking Sensor screen

The Parking sensor screen turns on when the front or rear sensor on your vehicle detects an obstacle within a certain distance.

Parking Sensor Full screen example

When the front or rear sensor detects an obstacle within a certain distance, the Parking Sensor screen is displayed, and the indicator that corresponds with that area lights up.

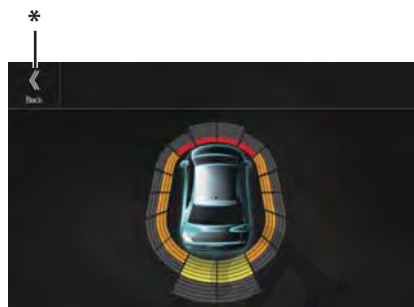

Indicator colours when an obstacle is detected.

Red: close distance
Orange: medium distance
Yellow: long distance

- Depending on the speed of the vehicle, when moving faster than a certain speed, the Parking Sensor screen may not be displayed.
- Vehicles that do not have the obstacle detection sensor cannot use this function.

* [⏪] is displayed only when the Rear camera is interlocked.

Parking Sensor Camera interlock screen example (Rear camera)

You can check for obstacles through an interlocked camera image by connecting a Rear Camera.

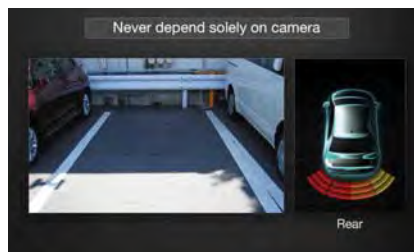

- Touch the Camera image area to switch to the Camera full screen. (While displaying the Camera full screen, touch the Camera screen, then touch [Sensor] to return to the Parking Sensor Camera interlock screen.)
- Touch the car icon to switch to the Parking sensor full screen. (Touch [⏪] on the Parking Sensor full screen to return to the Parking Sensor Camera interlock display.)
- To use this function, set the Camera Select setting to "Rear." For details, see "Setting the Camera Input" (page 41).

Information

Product Software Update

This product use software that can be updated through a USB flash drive. Download the software from the Alpine website and update the product using the USB flash drive.

Updating this product

Check the Alpine website for details on updating.

<http://www.alpine-europe.com>

Important information on the software

About the software licence of the product

The software installed in the product contains open-source software. See the following Alpine website for details on the open source software.

<http://www.alpine.com/e/oss/download>

About the Supported Formats

- For the list of video formats supported from a USB flash drive, see "About USB Video format" (page 55).

About MP3/WMA/AAC/FLAC



CAUTION

Except for private use, duplicating audio data (including MP3/WMA/AAC/FLAC data) or distributing, transferring, or copying it, whether for free or for a fee, without permission of the copyright holder is strictly prohibited by the Copyright Act and by international treaty.

What is MP3?

MP3, whose official name is "MPEG Audio Layer 3," is a compression standard prescribed by the ISO, the International Standardisation Organisation and MPEG which is a joint activity institution of the IEC.

MP3 files contain compressed audio data. MP3 encoding is capable of compressing audio data at extremely high ratios, reducing the size of music files to as much as one-tenth their original size. This is achieved while still maintaining near CD quality. The MP3 format realises such high compression ratios by eliminating the sounds that are either inaudible to the human ear or masked by other sounds.

What is WMA?

WMA, or "Windows Media™ Audio," is compressed audio data. WMA is similar to MP3 audio data.

What is AAC?

AAC is the abbreviation for "Advanced Audio Coding," and is a basic format of audio compression used by MPEG2 or MPEG4.

What is FLAC?

FLAC (Free Lossless Audio Codec) is an audio file codec for lossless compression, developed and offered as open source software. Codecs with lossy compression forms, such as MP3 and AAC, reduce part of the data to improve compression efficiency. However, FLAC can reconstruct compressed data to be an identical copy of the original data by performing lossless compression. The compression ratio of FLAC is about 50%.

Method for creating MP3/WMA/AAC/FLAC (USB Flash drive) files

Audio data is compressed using software with MP3/WMA/AAC/FLAC (USB Flash drive) codecs. For details on creating MP3/WMA/AAC/FLAC (USB Flash drive) files, refer to the user's manual for that software.

MP3/WMA/AAC/FLAC (USB Flash drive) files that are playable on this device have the file extensions.

MP3: "mp3"

WMA: "wma"

AAC: "m4a"

FLAC: "flac"/"fla"

WMA is not supported for the following files, Windows Media Audio Professional, Windows Media Audio 10 std or Windows Media Audio 10 Pro Lossless.

There are many different versions of the AAC format. Confirm that the software being used conforms to the acceptable formats listed above. It's possible that the format may be unplayable even though the extension is valid.

Playback of AAC files encoded by iTunes is supported.

Supported playback sampling rates and bit rates

MP3 (USB Flash drive)

Sampling rates: 48 kHz, 44.1 kHz, 32 kHz, 24 kHz, 22.05 kHz, 16 kHz, 12 kHz, 11.025 kHz, 8 kHz

Bit rates: 8 - 320 kbps

WMA (USB Flash drive)

Sampling rates: 48 kHz, 44.1 kHz, 32 kHz, 22.05 kHz, 16 kHz, 11.025 kHz, 8 kHz

Bit rates: 48 - 320 kbps

AAC (USB Flash drive)

Sampling rates: 48 kHz, 44.1 kHz, 32 kHz, 24 kHz, 22.05 kHz, 16 kHz, 12 kHz, 11.025 kHz, 8 kHz

Bit rates: 16 - 320 kbps

FLAC (USB Flash drive)

Sampling rates: 96kHz, 88.2kHz, 48kHz, 44.1kHz, 32kHz, 24kHz, 22.05kHz, 16kHz, 8kHz

Channel number: 1ch, 2ch

This device may not play back correctly depending on sampling rates.

ID3 tags/WMA tags

This device supports ID3 tag v1.0, v1.1, v2.2, v2.3, v2.4, and WMA tag Ver.1.x. If tag data is in an MP3/WMA/AAC file, this device can display the title (track title), artist name, and album name ID3 tag/WMA tag data.

For non-supported characters, "?" is displayed.

The number of characters may be limited, or not correctly displayed, depending on the tag information.

Playing back MP3/WMA/AAC/FLAC

MP3/WMA/AAC files are prepared, then written to a USB flash drive.

- Maximum numbers of playable files/folders
USB Flash drive: 10,000 files/folders (including Root Folder)
- Largest playable file size: 512 MB

Playback may not be performed if a disc exceeds the limitations described above.

If a file/folder name is long, the maximum possible number of files may decrease.

- Both Audio and Video files are counted if their formats are playable on this unit.

Media supported

The media that this device can play back a USB flash drive.

Corresponding File Systems

This device supports FAT 16/32.

The maximum nested folder depth is 8 (including the root directory). File names are limited to 256 characters (including the extension).

Valid characters for folder/file names are letters A-Z (all caps), numbers 0-9, and ' _ ' (underscore).

Order of files

Files are played back in the order that the writing software writes them to the disc. Therefore, the playback order may not be what's expected. Verify the writing order in the software's documentation. The playback order of the folders and files is as follows. (The following numbers may differ from actually displayed numbers.)

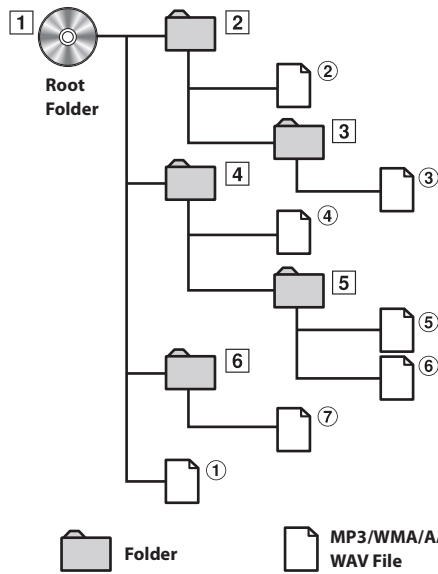

Terminology

Bit rate

This is the "sound" compression rate specified for encoding. The higher the bit rate, the higher the sound quality, but also the larger the files.

Sampling rate

This value shows how many times per second the data is sampled (recorded). For example, music CDs use a sampling rate of 44.1 kHz, so the sound is sampled (recorded) 44,100 times per second. The higher the sampling rate, the higher the sound quality, but also the larger the volume of data.

Encoding

Converting music CDs, WAVE (AIFF) files, and other sound files into the specified audio compression format.

Tag

Song information such as track titles, artist names, album names, etc., written into MP3/WMA/AAC/FLAC (USB flash drive) files.

Root folder

The root folder (or root directory) is found at the top of the file system. The root folder contains all folders and files. It is created automatically for all burned discs.

In Case of Difficulty

If you encounter a problem, please turn the power off, then on again. If the unit is still not functioning normally, please review the items in the following checklist. This guide will help you isolate the problem if the unit is at fault. Otherwise, make sure the rest of your system is properly connected, or then consult your authorized Alpine dealer.

Basic

No function or display.

- Vehicle's ignition is off.
 - If connected according to the instructions, the unit will not operate with the vehicle's ignition off.
- Improper power lead connections.
 - Check power lead connections.
- Blown fuse.
 - Check the fuse on the battery lead of the unit; replace with the proper value if necessary.
- Internal micro-computer malfunctioned due to interference noise, etc.
 - Press the RESET switch with a ballpoint pen or other pointed article.

No sound or unnatural sound.

- Incorrect setting of volume/balance/fader controls.
 - Readjust the controls.
- Connections are not properly or securely made.
 - Check the connections and firmly connect.

Screen not displayed.

- Brightness/Contrast control is set at the minimum position.
 - Adjust the Brightness/Contrast control.
- Temperature in the vehicle is too low.
 - Increase the vehicle's interior temperature to operation temperature range.
- Connections to the Auxiliary Device are not securely made.
 - Check the connections and firmly connect.
- The Parking Brake Lead is not connected.
- The Parking Brake is not engaged.
 - Connect the Parking Brake Lead, then engage the Parking Brake.

Movement of displayed picture is abnormal.

- Temperature in the vehicle is too high.
 - Allow the vehicle's interior temperature to cool.

Radio

Unable to receive stations.

- No antenna, or open connection in the antenna cable.
 - Make sure the antenna is properly connected; replace the antenna or cable if necessary.

Unable to tune stations in the seek mode.

- You are in a weak signal area.
 - Make sure the tuner is in DX mode.
- If the area you are in is a primary signal area, the antenna may not be grounded and connected properly.
 - Check your antenna connections; make sure the antenna is properly grounded at its mounting location.

- The antenna may not be the proper length.
 - Make sure the antenna is fully extended; if broken, replace the antenna with a new one.

Broadcast is noisy.

- The antenna is not the proper length.
 - Extend the antenna fully; replace it if it is broken.
- The antenna is poorly grounded.
 - Make sure the antenna is grounded properly at its mounting location.
- The station signal is weak and noisy.
 - If above solution does not work, tune in another station.

USB Audio

Unit does not operate.

- Condensation.
 - Wait a while (about 1 hour) for the condensation to dry.

Picture is unclear or noisy.

- Vehicle's battery power is weak.
 - Check the battery power and wiring.
(The unit may malfunction if the battery power is under 11 volts with a load applied.)

If this Message Appears

Various messages are displayed on the screen during operation. In addition to the messages telling you the current status or providing guidance for the next operation, there are also the following error messages. If one of these error messages is displayed, carefully follow the instructions in the solution column.

System

If you are driving, please pull over before using this function.

- A setup operation, etc., was carried out while the vehicle was running.
 - Move the vehicle to a safe location, stop, and engage the parking brake, then carry out this operation.

USB current error.

- Abnormal current is run to the USB connector device.
 - Turn the ignition key off, and then set to ON again.
 - Attempt to connect another iPod/iPhone/USB Flash drive.

USB HUB is not supported.

- A USB flash drive with a hub is connected.
 - You cannot play back from a USB flash drive with a hub. USB hub connections are also not supported.

File Format not supported.

- A USB Video file that is not supported by this unit is selected.
 - Check if the video file is playable by seeing "About USB Video format" (page 55).
-

Audio/Visual

Connected USB device is not supported.

- An iPod/iPhone that is not supported by the unit is connected.
 - Connect an iPod/iPhone that is supported by the unit.
 - Reset the iPod.
 - A USB device that is not supported by the unit is connected.
 - Attempt to connect another USB flash drive.
 - Communication error.
 - Turn the ignition key off, and then set to ON again.
 - Check the display by reconnecting between the iPod/iPhone and the unit, using the iPod/iPhone cable.
 - Check the display by reconnecting between the USB flash drive and the unit.
 - Caused by the iPod/iPhone Software Version not being compatible with this unit.
 - Update the iPod/iPhone Software Version to be compatible with this unit.
 - The iPod/iPhone is not verified.
 - Change to another iPod/iPhone.
-

No data.

- There are no data in the iPod/iPhone.
 - Download data to the iPod/iPhone and connect to the unit.
 - There are no data in the USB flash drive.
 - Download data to the USB flash drive and connect to this unit.
-

Un-readable song was skipped.

- A copy-protected WMA file has been detected.
 - You can only play back non-copy-protected files.
 - A sampling rate/bit rate not supported by the unit is used.
 - Use a sampling rate/bit rate supported by the unit.
-

DAB Antenna error

- The DAB antenna cable is either damaged or not connected correctly to the product.
 - Check that the antenna cable is not kinked or otherwise damaged. Replace the antenna if necessary.
 - Abnormal current is run to the DAB Antenna.
 - Connect the antenna properly to a car with a 12 volt negative ground.
-

Bluetooth

Please connect Bluetooth audio device.

- The Bluetooth audio device was not connected correctly.
 - Check the settings for the unit and the Bluetooth audio device and reconnect.
-

Unable to download phonebook.

- Phonebook failed to read due to mobile phone disconnection, etc.
 - Check the mobile phone connection, and then conduct synchronising and adding again. (See page 64)
 - The connected mobile phone does not support synchronising of its phone book.
 - Connect the mobile phone that supports synchronising the phone book, then synchronise again. (See page 64)
-

HDMI

HDMI communication error,

Please check your device and operate it again.

- Communication error.
 - Turn the ignition key off, and then set to ON again.
 - Check the display by reconnecting between the HDMI device and the unit.
-

HDMI current error,

Please Connect your device again.

- Abnormal current is run to the HDMI connector device.
 - Turn the ignition key off, and then set to ON again.
 - Disconnect the HDMI device from the unit, and then reconnect it.
-

CAN Interface

CAN Communication Error

- Communication error.
 - Check the CAN Interface box connection.
-

Applying Alpine TuneIt App

You can not use Sound App

Because External AP is on.

- "Setting the External AP" (page 43) is "On."
 - When "External AP" (page 43) is set to "On," you cannot perform Sound Tuning from the Alpine TuneIt App. Set "External AP" to "Off" to perform Sound Tuning from the Alpine TuneIt App.
-

No operation

- Moisture condensation
 - Allow enough time for the condensation to evaporate (about 1 hour).
 - Ambient Temperature
 - Make sure the temperature inside the vehicle is between 0°C and 45°C (32°F and 113°F).
-

Specifications

MONITOR SECTION

Screen Size	9"
LCD Type	Transparent type TN LCD
Operation System	TFT active matrix
Number of Picture Elements	1,152,000 pcs. (800 × 480 × 3 (RGB))
Effective Number of Picture Elements	99% or more
Illumination System	LED

FM TUNER SECTION

Tuning Range	87.5 – 108.0 MHz
Mono Usable Sensitivity	8.1 dBf (0.7 μV/75 ohms)
50 dB Quieting Sensitivity	12 dBf (1.1 μV/75 ohms)
Alternate Channel Selectivity	80 dB
Signal-to-Noise Ratio	65 dB
Stereo Separation	35 dB
Capture Ratio	2.0 dB

MW TUNER SECTION

Tuning Range	531 – 1,602 kHz
Usable Sensitivity	25.1 μV/28 dBf

LW TUNER SECTION

Tuning Range	153 – 281 kHz
Sensitivity (IEC Standard)	31.6 μV/30 dBf

DAB SECTION

Tuning Range BAND III	174.93 – 239.2 MHz
Tuning Range L-BAND	1,452.96 – 1,490.6 MHz
Usable Sensitivity	-103 dBm
Signal-to-Noise Ratio	95 dB
Stereo Separation	85 dB

USB SECTION

USB requirements	USB 2.0
Max. Power Consumption	1,500 mA (CDP Support)
USB Class	USB (Mass Storage Class)
File System	FAT16/32
Number of Channels	2-Channels (Stereo)
Frequency Response*1	5 – 20,000 Hz (±1 dB)
Total Harmonic Distortion	0.008% (at 1 kHz)
Dynamic Range	95 dB (at 1 kHz)
Signal-to-Noise Ratio	100 dB
Channel Separation	85 dB (at 1 kHz)

*1 Frequency response may differ depending on the encoder software/bit rate.

HDMI SECTION

Input Format	480p/VGA
--------------	----------

GPS SECTION

GPS Reception frequency	1,575.42 ±1 MHz
GPS Reception sensitivity	-130 dB max.

GLONASS SECTION

GLONASS Reception frequency	1,597.807 MHz - 1,605.6305 MHz
GLONASS Reception sensitivity	-130 dB max.

Bluetooth SECTION

Bluetooth Specification	Bluetooth V3.0
Frequency band	2,402 - 2,480 MHz
Output Power	+4 dBm Max. (Power class 2)
Profile	HFP (Hands-Free Profile) OPP (Object Push Profile) PBAP (Phone Book Access Profile) A2DP (Advanced Audio Distribution Profile) AVRCP (Audio/Video Remote Control Profile) SPP (Serial Port Profile)

GENERAL

Power Requirement	14.4 V DC (11–16 V allowable)
Operating temperature	-4°F to +140°F (-20°C to + 60°C)
Maximum Power Output	50 W × 4
Audio output level	Preout (Front, Rear): 4V/10k ohms (max.) Preout (Subwoofer): 4V/10k ohms (max.)
Weight	2.56 kg (5 lbs. 10 oz)

CHASSIS SIZE

Width	178 mm (7")
Height	50 mm (2")
Depth	160 mm (6-5/16")

- Due to continuous product improvement, specifications and design are subject to change without notice.
- The LCD panel is manufactured using an extremely high precision manufacturing technology. Its effective pixel ratio is over 99.99%. This means that there is a possibility that 0.01% of the pixels could be either always ON or OFF.

About the Rules of Bluetooth Electromagnetic Radiation Regulation



Declaration of Conformity

DEVICES THAT EMIT RADIO WAVES. The following products and systems on your vehicle emit radio waves when in operation.

SIMPLIFIED EU DECLARATION OF CONFORMITY

Hereby, ALPINE ELECTRONICS, INC. declares that the radio equipment type iLX-F903D is in compliance with Directive 2014/53/EU. The full text of the EU declaration of conformity is available at the following internet address:

<http://www.alpine.com/e/research/doc/>

Compliant with UNECE Regulation 10 (E-Mark)



[EN] English	Hereby, Alpine Electronics, inc. declares that the radio equipment type iLX-F903D is in compliance with Directive 2014/53/EU. The full text of the EU declaration of conformity is available at the following internet address: http://www.alpine.com/e/research/doc/
[BG] Bulgarian	С настоящото Alpine Electronics, inc. декларира, че този тип радиос ъоръжение iLX-F903D е в съответствие с Директива 2014/53/ЕС. Цялостният текст на ЕС декларацията за съответствие може да се намери на следния интернет адрес: http://www.alpine.com/e/research/doc/
[CZ] Czech	Tímto Alpine Electronics, inc. prohlašuje, že typ rádiového zařízení iLX-F903D je v souladu se směrnicí 2014/53/EU. Úplné znění EU prohlášení o shodě je k dispozici na této internetové adrese: http://www.alpine.com/e/research/doc/
[DA] Danish	Hermed erklærer Alpine Electronics, inc., at radioudstyrstypen iLX-F903D er i overensstemmelse med direktiv 2014/53/EU. EU-overensstemmelseserklæringens fulde tekst kan findes på følgende internetadresse: http://www.alpine.com/e/research/doc/
[DE] German	Hiermit erkläre Alpine Electronics, inc., dass der Funkanlagentyp iLX-F903D der Richtlinie 2014/53/EU entspricht. Der vollständige Text der EU-Konformitätserklärung ist unter der folgenden Internetadresse verfügbar: http://www.alpine.com/e/research/doc/
[EL] Greek	Με την παρούσα ο/η Alpine Electronics, inc., δηλώνει ότι ο ραδιοεξοπλισμός iLX-F903D πληροί την οδηγία 2014/53/ΕΕ. Το πλήρες κείμενο της δήλωσης συμμόρφωσης ΕΕ διατίθεται στην ακόλουθη ιστ οσελίδα στο διαδίκτυο: http://www.alpine.com/e/research/doc/
[ES] Spanish	Por la presente, Alpine Electronics, inc. declara que el tipo de equiporadioeléctrico iLX-F903D es conforme con la Directiva 2014/53/UE. El texto completo de la declaración UE de conformidad está disponible en la dirección Internet siguiente: http://www.alpine.com/e/research/doc/
[ET] Estonian	Käesolevaga deklareerib Alpine Electronics, inc. et käesolev raadioseadme tüüp iLX-F903D vastab direktiivi 2014/53/EL nõuetele. ELi vastavusdeklaratsiooni täielik tekst on kättesaadav järgmisel internetiaadressil: http://www.alpine.com/e/research/doc/
[FI] Finnish	Alpine Electronics, inc. vakuuttaa, että radiolaitetyypin iLX-F903D on direktiivin 2014/53/EU mukainen. EU-vaatimustenmukaisuusvakuutuksen täysimittainen teksti on saatavilla seuraavassa internetosoitteessa: http://www.alpine.com/e/research/doc/
[FR] French	Le soussigné, Alpine Electronics, inc., déclare que l'équipement radioé lectrique du type iLX-F903D est conforme à la directive 2014/53/UE. Le texte complet de la déclaration UE de conformité est disponible à l'adresse internet suivante: http://www.alpine.com/e/research/doc/
[HR] Croatian	Alpine Electronics, inc. ovime izjavljuje da je radijska oprema tipa iLX-F903D u skladu s Direktivom 2014/53/EU. Cjeloviti tekst EU izjave o sukladnosti dostupan je na sljedećoj internetskoj adresi: http://www.alpine.com/e/research/doc/
[HU] Hungarian	Alpine Electronics, inc. igazolja, hogy a iLX-F903D típusú rádióberendezés s megfelel a 2014/53/EU irányelvnek. Az EU-megfelelőségi nyilatkozat teljes szövege elérhető a következő internetes címen: http://www.alpine.com/e/research/doc/
[IS] Icelandic	Hér, Alpine Electronics, inc. lýsir yfir að radióbúnaður tegund iLX-F903D er í samræmi við tilskipun 2014/53/ESB. The fullur texti af ESB-samræmisýfirlýsing er í boði á eftirfarandi veffangi: http://www.alpine.com/e/research/doc/
[IT] Italian	Il fabbricante, Alpine Electronics, inc., dichiara che il tipo di apparecchiatura radio iLX-F903D è conforme alla direttiva 2014/53/UE. Il testo completo della dichiarazione di conformità UE è disponibile al seguente indirizzo Internet: http://www.alpine.com/e/research/doc/
[LT] Lithuanian	Aš, Alpine Electronics, inc., patvirtinu, kad radijo įrenginių tipas iLX-F903D atitinka Direktyvą 2014/53/ES. Visas ES atitikties deklaracijos tekstas prieinamas šiuo interneto adresu: http://www.alpine.com/e/research/doc/
[LV] Latvian	Ar šo Alpine Electronics, inc. deklarē, ka radioiekārta iLX-F903D atbilst Direktīvai 2014/53/ES. Pilns ES atbilstības deklarācijas teksts ir pieejams šādā interneta vietnē: http://www.alpine.com/e/research/doc/
[MT] Maltese	B'dan, Alpine Electronics, inc., niddikjara li dan it-tip ta' tagħmir tar-radju iLX-F903D huwa konformi mad-Direttiva 2014/53/UE. It-test kollu tad-dikjarazzjoni ta' konformità tal-UE huwa disponibbli f'dan l-indirizz tal-Internet li ġej: http://www.alpine.com/e/research/doc/
[NL] Dutch	Hierbij verklaar ik, Alpine Electronics, inc., dat het type radioapparatuur iLX-F903D conform is met Richtlijn 2014/53/EU. De volledige tekst van de EU-conformiteitsverklaring kan worden geraadpleegd op het volgende internetadres: http://www.alpine.com/e/research/doc/

[NO] Norwegian	Herved Alpine Electronics, inc. erklærer at radioutstyr type iLX-F903D er i samsvar med direktiv 2014/53/EU. Den fullstendige teksten i EU-erklæring er tilgjengelig på følgende internettadresse: http://www.alpine.com/e/research/doc/
[PL] Polish	Alpine Electronics, inc. niniejszym oświadcza, że typ urządzenia radiowego iLX-F903D jest zgodny z dyrektywą 2014/53/UE. Pełny tekst deklaracji zgodności UE jest dostępny pod następującym adresem internetowym: http://www.alpine.com/e/research/doc/
[PT] Portuguese	O(a) abaixo assinado(a) Alpine Electronics, inc. declara que o presente tipo de equipamento de rádio iLX-F903D está em conformidade com a Diretiva 2014/53/UE. O texto integral da declaração de conformidade está disponível no seguinte endereço de Internet: http://www.alpine.com/e/research/doc/
[RO] Romanian	Prin prezenta, Alpine Electronics, inc. declară că tipul de echipamente radio iLX-F903D este în conformitate cu Directiva 2014/53/UE. Textul integral al declarației UE de conformitate este disponibil la următoarea adresă internet: http://www.alpine.com/e/research/doc/
[SK] Slovak	Alpine Electronics, inc. týmto vyhlasuje, že rádiové zariadenie typu iLX-F903D je v súlade so smernicou 2014/53/EÚ. Úplné EÚ vyhlásenie o zhode je k dispozícii na tejto internetovej adrese: http://www.alpine.com/e/research/doc/
[SL] Slovenian	Alpine Electronics, inc. potrjuje, da je tip radijske opreme iLX-F903D skladen z Direktivo 2014/53/EU. Celotno besedilo izjave EU o skladnosti je na voljo na naslednjem spletnem naslovu: http://www.alpine.com/e/research/doc/
[SV] Swedish	Härmed försäkrar Alpine Electronics, inc. att denna typ av radioutrustning iLX-F903D överensstämmer med direktiv 2014/53/EU. Den fullständiga texten till EU-försäkran om överensstämmelse finns på följande webbadress: http://www.alpine.com/e/research/doc/
[TR] Turkey	İşbu beyanla, Alpine Electronics, inc. radyo ekipmanı tipinin iLX-F903D, Directive 2014/53/EU yönergeline uyduğunu ilan eder. EU uyumluluk ilanının tam metnine (Declaration of Conformity) aşağıdaki internet adresinden ulaşılabilir. http://www.alpine.com/e/research/doc/

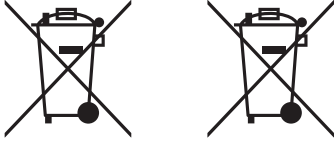

Information on Disposal of Old Electrical and Electronic Equipment and Battery (applicable for countries that have adopted separate waste collection systems)

If you want to dispose this product, do not mix it with general household waste. There is a separate collection system for used electronic products in accordance with legislation that requires proper treatment, recovery and recycling. Contact your local authority for details in locating a recycle facility nearest to you. Proper recycling and waste disposal will help conserve resources whilst preventing detrimental effects on our health and the environment.

130.com.ua