



PHONES

0 (800) 800 130
(050) 462 0 130
(063) 462 0 130
(067) 462 0 130

130
COM.UA

Internet store of
autogoods



SKYPE

km-130

CAR RECEIVERS — Receivers • Media receivers and stations • Native receivers • CD/DVD changers • FM-modulators/USB adapters • Flash memory • Facia plates and adapters • Antennas • Accessories |
CAR AUDIO — Car audio speakers • Amplifiers • Subwoofers • Processors • Crossovers • Headphones • Accessories | TRIP COMPUTERS — Universal computers • Model computers • Accessories |
GPS NAVIGATORS — Portable GPS • Built-in GPS • GPS modules • GPS trackers • Antennas for GPS navigators • Accessories | VIDEO — DVR • TV sets and monitors • Car TV tuners • Cameras • Videomodules
• Transcoders • Car TV antennas • Accessories | SECURITY SYSTEMS — Car alarms • Bike alarms • Mechanical blockers • Immobilizers • Sensors • Accessories | OPTIC AND LIGHT — Xenon • Bixenon • Lamps
• LED • Stroboscopes • Optic and Headlights • Washers • Light, rain sensors • Accessories | PARKTRONICS AND MIRRORS — Rear parktronic • Front parktronic • Combined parktronic • Rear-view mirrors
• Accessories | HEATING AND COOLING — Seat heaters • Mirrors heaters • Screen-wipers heaters • Engine heaters • Auto-refrigerators • Air conditioning units • Accessories | TUNING — Vibro-isolation
• Noise-isolation • Tint films • Accessories | ACCESSORIES — Radar-detectors • Handsfree, Bluetooth • Windowlifters • Compressors • Beeps, loudspeakers • Measuring instruments • Cleaners • Car seats
• Miscellaneous | MOUNTING — Installation kits • Upholstery • Grilles • Tubes • Cable and wire • Tools • Miscellaneous | POWER — Batteries • Converters • Start-charging equipment • Capacitors
• Accessories | MARINE AUDIO AND ELECTRONICS — Marine receivers • Marine audio speakers • Marine subwoofers • Marine amplifiers • Accessories | CAR CARE PRODUCTS — Additives • Washer fluid •
Care accessories • Car polish • Flavors • Adhesives and sealants | LIQUID AND OIL — Motor oil • Transmission oil • Brake fluid • Antifreeze • Technical lubricant



In store "130" you can find and buy almost all necessary goods for your auto in Kyiv and other cities, delivery by ground and postal services. Our experienced consultants will provide you with exhaustive information and help you to choose the very particular thing. We are waiting for you at the address

<https://130.com.ua>



FMB140

Advanced tracker with
CAN data reading feature

Quick
Manual
v1.4

Table of Contents

Know your device	3
Pinout.....	4
Wiring scheme.....	5
Set up your device	6
How to insert Micro-SIM card and connect the battery.....	6
PC Connection (Windows).....	7
How to install USB drivers (Windows).....	7
Configuration (Windows)	7
Quick SMS configuration	10
Mounting recommendations	11
LED indications	12
Characteristics	12
Basic characteristics	12
Electrical characteristics.....	14
Safety information	16
Certification and Approvals	17

Warranty	18
Warranty Disclaimer.....	18

Know your device

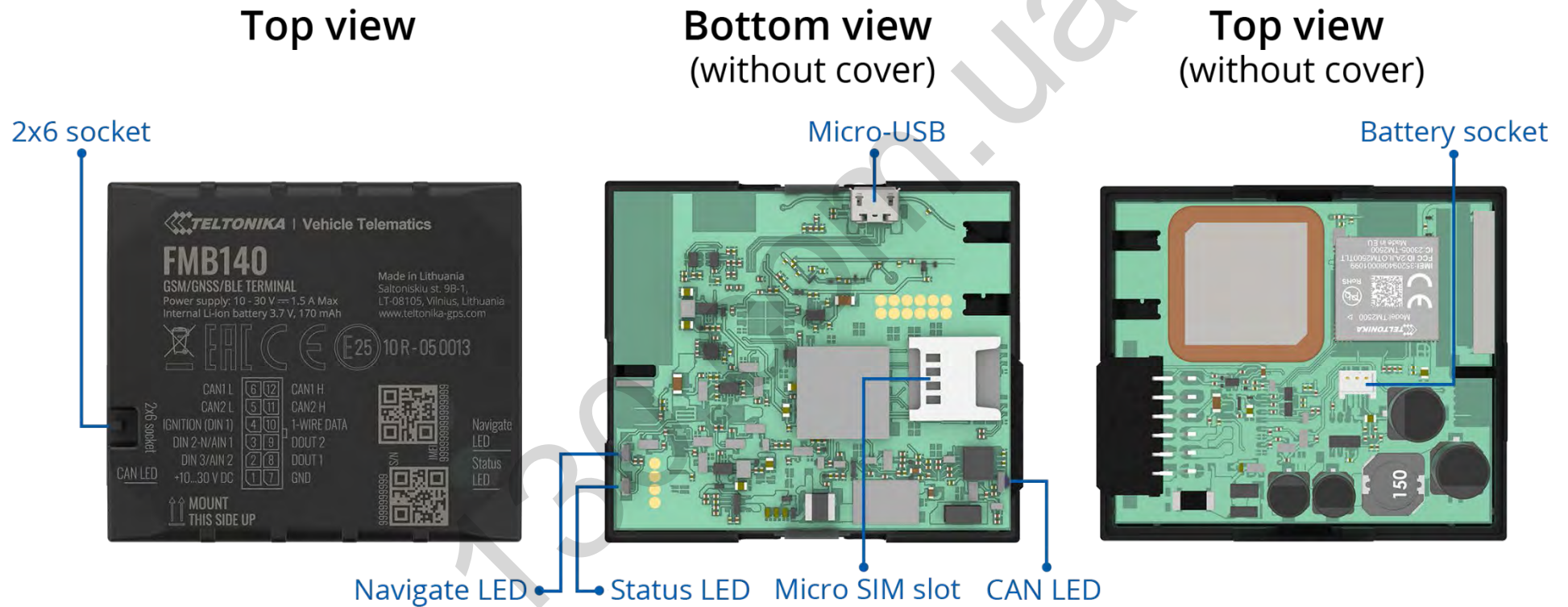

Figure 1 FMB140 device view

Pinout

Table 1 FMB140 2x6 socket pinout

PINNUMBER	PINNAME	DESCRIPTION
1	VCC (10-30)V DC (+)	Power supply (+10-30 V DC).
2	DIN 3 / AIN 2	Analog input, channel 2. Input range: 0-30 V DC / Digital input, channel 3.
3	DIN2-N / AIN1	Digital input, channel 2 / Analog input, channel 2. Input range: 0-30 V DC /GND Sense input
4	DIN1	Digital input, channel 1.
5	CAN2L	CAN LOW, 2 nd line
6	CAN1L	CAN LOW, 1 st line
7	GND (-)	Ground pin. (10-30)V DC (—)
8	DOUT 1	Digital output, channel 1. Open collector output. Max. 0,5 A DC..
9	DOUT 2	Digital output, channel 2. Open collector output. Max. 0,5 A DC.
10	1WIRE DATA	Data for 1-Wire devices.
11	CAN2H	CAN HIGH, 2 nd line
12	CAN1H	CAN HIGH, 1 st line



Figure 2 FMB140 2x6 socket pinout

Wiring scheme

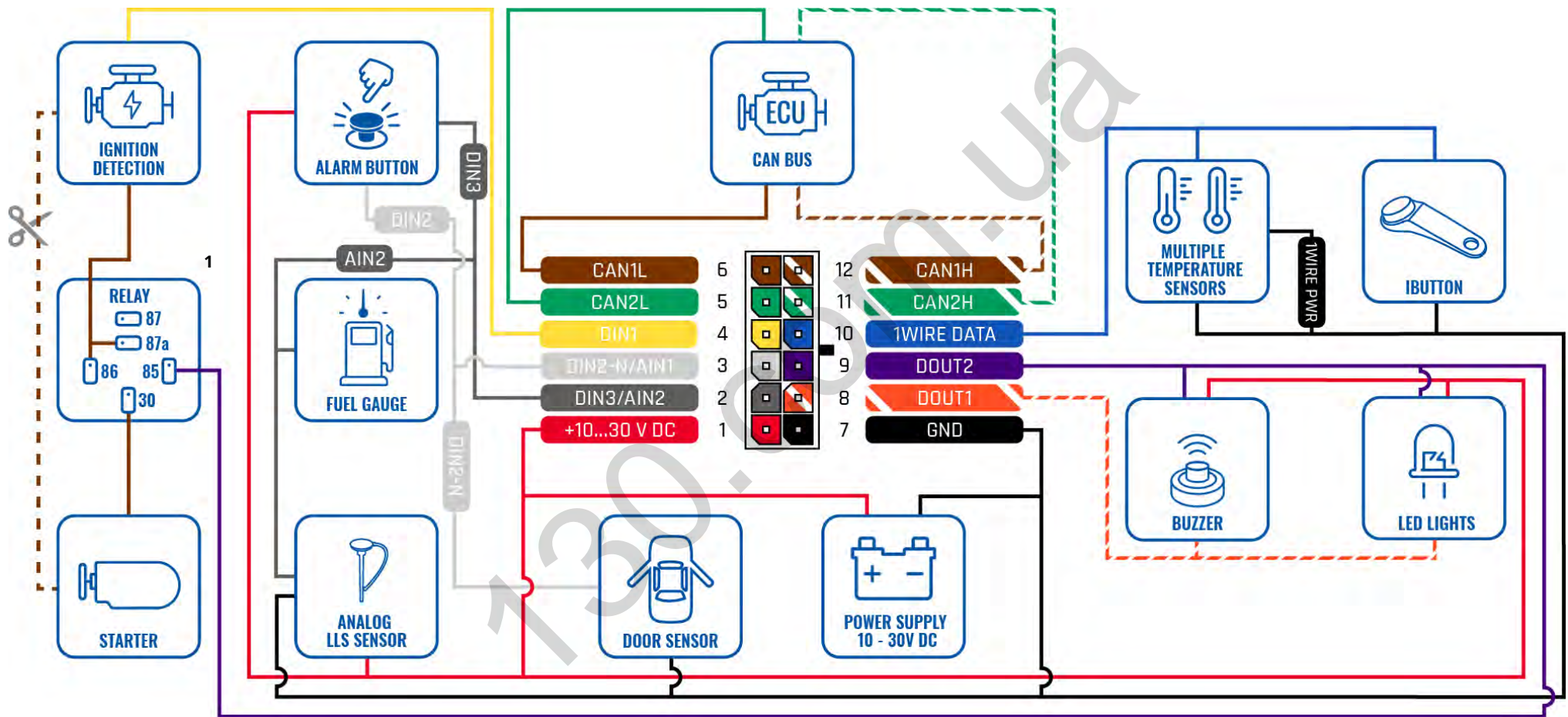

Figure 3 FMB140 Wiring scheme

¹ Automotive relay

Set up your device

How to insert Micro-SIM card and connect the battery

1. Gently remove FMB140 **cover** using **plastic pry tool** from both sides.
2. Insert **Micro-SIM** card as shown with **PIN request disabled** or read our [Wiki](#) how to enter it later in [Teltonika Configurator](#). Make sure that Micro-SIM card **cut-off corner** is pointing forward to slot.
3. Connect **battery** as shown to device. Position the battery in place where it does not obstruct other components.
4. After **configuration**, see "[PC Connection \(Windows\)](#)", attach device **cover** back.

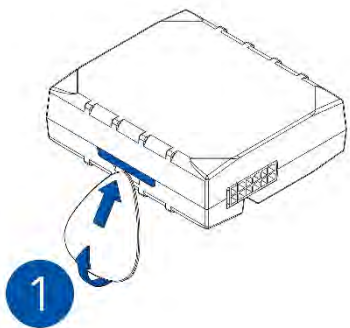

Figure 4 Cover removal

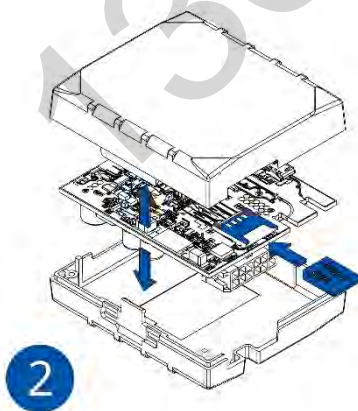

Figure 5 Micro-SIM card insert

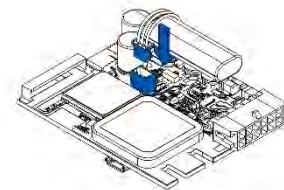

Figure 6 Battery connection

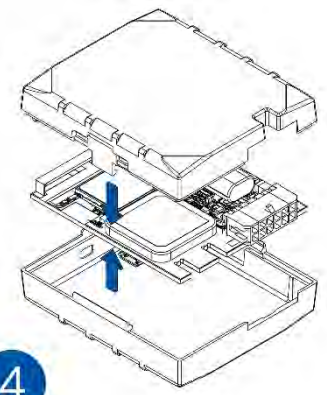

Figure 7 Attaching cover back

PC Connection (Windows)

1. Power-up FMB140 with **DC voltage (10 – 30 V)** power supply using **supplied power cable**. LED's should start blinking, see "[LED indications](#)".
2. Connect device to computer using **Micro-USB cable** or **Bluetooth** connection:
 - Using **Micro-USB cable**
 - You will need to install USB drivers, see "[How to install USB drivers \(Windows\)](#)"
 - Using **Bluetooth**
 - FMB140 Bluetooth is enabled by default. Turn on **Bluetooth** on your PC, then select **Add Bluetooth or other device > Bluetooth**. Choose your device named – "**FMBxxx_last_7_imei_digits**", without **LE** in the end. Enter default password **5555**, press **Connect** and then select **Done**.
3. You are now ready to use the device on your computer.

How to install USB drivers (Windows)

1. Please download COM port drivers from [here](#).
2. Extract and run **TeltonikaCOMDriver.exe**.
3. Click **Next** in driver installation window.
4. In the following window click **Install** button.

Setup will continue installing the driver and eventually the confirmation window will appear. Click **Finish** to complete the setup.

Configuration (Windows)

At first FMB140 device will have default factory settings set. These settings should be changed according to the user's needs. Main configuration can be performed via [Teltonika Configurator](#) software. Get the latest **Configurator** version from [here](#). Configurator operates on **Microsoft Windows OS** and uses prerequisite **MS .NET Framework**. Make sure you have the correct version installed.

Table 2 MS .NET requirements

MS.NET REQUIREMENTS			
Operating system	MS .NET Framework version	Version	Links
Windows Vista Windows 7 Windows 8.1 Windows 10	MS .NET Framework 4.6.2	32 and 64 bit	www.microsoft.com

Downloaded **Configurator** will be in compressed archive. Extract it and launch **Configurator.exe**. After launch software language can be changed by clicking  in the right bottom corner ([Figure 8 Language selection](#)).

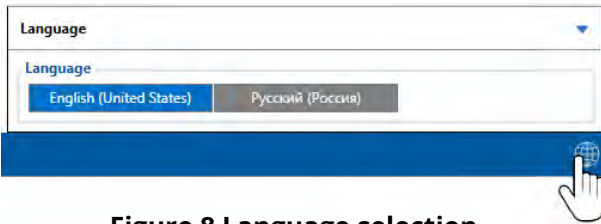

Figure 8 Language selection

Configuration process begins by pressing on connected device (Figure 9 Device connected via USB).



Figure 9 Device connected via USB

After connection to Configurator **Status window** will be displayed (Figure 10 Configurator Status window).

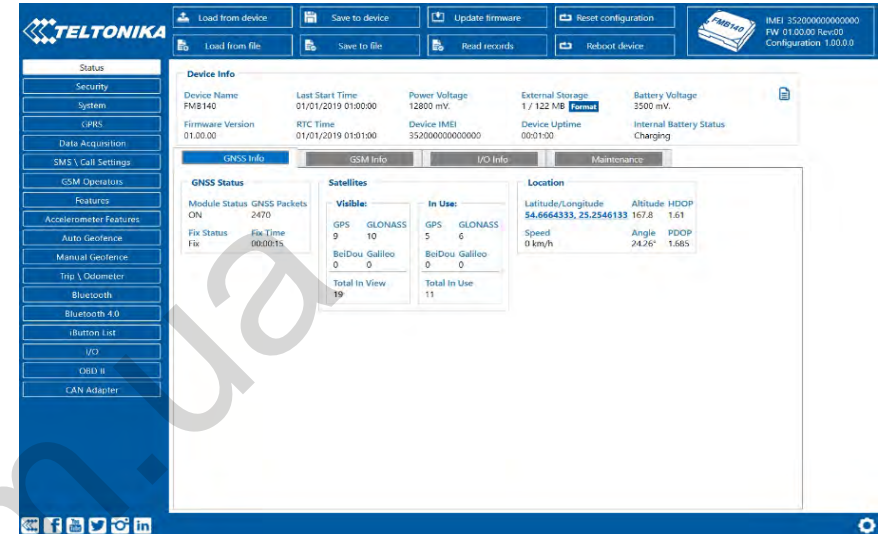



Figure 10 Configurator Status window

Various **Status window** tabs display information about **GNSS**, **GSM**, **I/O**, **Maintenance** and etc. FMB140 has one user editable profile, which can be loaded and saved to the device. After any modification of configuration the changes need to be saved to device using **Save to device** button. Main buttons offer following functionality:

1. **Load from device** – loads configuration from device.
2. **Save to device** – saves configuration to device.
3. **Load from file** – loads configuration from file.
4. **Save to file** – saves configuration to file.
5. **Update firmware** – updates firmware on device.
6. **Read records** – reads records from the device.

7.  **Reboot device** – restarts device.
8.  **Reset configuration** – sets device configuration to default.

Most important configurator section is **GPRS** – where all your server and [GPRS settings](#) can be configured and [Data Acquisition](#) – where data acquiring parameters can be configured.

More details about FMB140 configuration using Configurator can be found in our [Wiki](#).

130.com.ua

Quick SMS configuration

Default configuration has optimal parameters present to ensure best performance of track quality and data usage.

Quickly set up your device by sending this SMS command to it:

```
" setparam 2001:APN;2002:APN_username;2003:APN_password;2004:Domain;2005:Port;2006:0"
```

Note: Before SMS text, two space symbols should be inserted.

GPRS settings:

- 2001 – APN
- 2002 – APN username (if there are no APN username, empty field should be left)
- 2003 – APN password (if there are no APN password, empty field should be left)

Server settings:

- 2004 – Domain
- 2005 – Port
- 2006 – Data sending protocol (0 – TCP, 1 – UDP)



Default configuration settings

Movement and ignition detection:

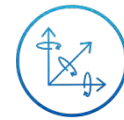

Vehicle movement will be detected by accelerometer



Ignition will be detected by vehicle power voltage between 13,2 – 30 V

Device makes a record **On Moving** if one of these events happen:



300 seconds passes



Vehicle turns 10 degrees



Vehicle drives 100 meters

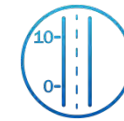

Speed difference between last coordinate and current position is greater than 10 km/h

Device makes a record **On Stop** if:



1 hour passes while vehicle is stationary and ignition is off

Records sending to server:



If device has made a record it is sent to the server every 120 seconds

After successful SMS configuration, FMB140 device will **synchronize time** and **update records** to **configured server**. Time intervals and default I/O elements can be changed by using [Teltonika Configurator](#) or [SMS parameters](#).

Mounting recommendations

- Connecting wires
 - Wires should be connected while the module is not plugged in.
 - Wires should be fastened to stable wires or other non-moving parts. Any heat emitting and/or moving objects should be kept away from the wires.
 - There should be no exposed wires. If factory isolation was removed while connecting the wires, the isolation material should be applied.
 - If the wires are placed in the exterior or in places where they can be damaged or exposed to heat, humidity, dirt, etc., additional isolation should be applied and the wires should not be loose.
 - Wires cannot be connected to the board computers or control units.
- Connecting power source
 - Be sure that after the car computer goes to sleep mode, power might be still available on the power wires. Depending on the car model, this may happen in 5 to 30 minutes period.
 - When the module is connected, measure the voltage again to make sure it did not decrease.
 - It is recommended to connect to the main power cable in the fuse box.
- 3 A, 125 V external fuse shall be used.
- Connecting ignition wire
 - Be sure to check if it is a real ignition wire i. e. power does not disappear after starting the engine.
 - Check if this is not an ACC wire (when key is in the first position, most of the vehicle electronics are available).
 - Check if power is still available when you turn off any of vehicles devices.
 - Ignition is connected to the ignition relay output. As alternative, any other relay, which has power output when ignition is on, may be chosen.
- Connecting ground wire
 - Ground wire is connected to the vehicle frame or metal parts that are fixed to the frame.
 - If the wire is fixed with the bolt, the loop must be connected to the end of the wire.
 - For better contact scrub paint from the spot where loop is going to be connected.

LED indications

Table 3 Navigation LED indications

BEHAVIOR	MEANING
Permanently switched on	GNSS signal is not received
Blinking every second	Normal mode, GNSS is working
Off	GNSS is turned off because: Device is not working or Device is in sleep mode
Blinking fast constantly	Device firmware is being flashed

Table 4 Status LED indications

BEHAVIOR	MEANING
Blinking every second	Normal mode
Blinking every two seconds	Sleep mode
Blinking fast for a short time	Modem activity
Off	Device is not working or Device is in boot mode

Table 5 CAN Status LED indications

BEHAVIOR	MEANING
Blinking fast constantly	Reading CAN data from vehicle
Permanently switched on	Wrong program number or wrong wire connection
Off	Wrong connection or CAN processor in sleep mode

Characteristics

Basic characteristics

Table 6 Basic characteristics

MODULE	
Name	Teltonika TM2500
Technology	GSM, GPRS, GNSS, BLUETOOTH
GNSS	
GNSS	GPS, GLONASS, GALILEO, BEIDOU, QZSS, AGPS
Receiver	Tracking: 33
Tracking sensitivity	-165 dBm
Accuracy	< 3 m
Hot start	< 1 s
Warm start	< 25 s
Cold start	< 35 s
CELLULAR	
Technology	GSM
2G bands	Quad-band 850/900/1800/1900 MHz
Data transfer	GPRS Multi-Slot Class 12 (up to 240 kbps), GPRS Mobile Station Class B
Data support	SMS (text/data)

POWER

Input voltage range	10-30 V DC with overvoltage protection
Back-up battery	170 mAh Li-Ion battery 3.7 V (0.63 Wh)
Internal fuse	3 A, 125 V
Power consumption	At 12V < 6 mA (Ultra Deep Sleep) At 12V < 8 mA (Deep Sleep) At 12V < 11 mA (Online Deep Sleep) At 12V < 20 mA (GPS Sleep) At 12V < 35 mA (nominal with no load) At 12V < 1.5 A Max. (with full Load / Peak)

BLUETOOTH

Specification	4.0 + LE
Supported peripherals	Temperature and Humidity sensor , Headset , OBDII dongle , Inateck Barcode Scanner, Universal BLE sensors support

INTERFACE

Digital Inputs	3
Negative Inputs	1 (Digital input 2)
Digital Outputs	2
Analog Inputs	2
CAN interfaces	2
1-Wire	1 (1-Wire data)
GNSS antenna	Internal High Gain
GSM antenna	Internal High Gain
USB	2.0 Micro-USB
LED indication	3 status LED lights
SIM	Micro-SIM + eSIM
Memory	128MB internal flash memory

PHYSICAL SPECIFICATION

Dimensions	65 x 56.6 x 20.6 mm (L x W x H)
Weight	55 g

OPERATING ENVIRONMENT

Operating temperature (without battery)	-40 °C to +85 °C
Storage temperature (without battery)	-40 °C to +85 °C
Operating humidity	5% to 95% non-condensing
Ingress Protection Rating	IP41
Battery charge temperature	0 °C to +45 °C
Battery discharge temperature	-20 °C to +60 °C
Battery storage temperature	-20 °C to +45 °C for 1 month -20 °C to +35 °C for 6 months

FEATURES

CAN Data	Fuel Level (Dashboard), Total fuel consumption, Vehicle speed (wheel), Vehicle driven distance, Engine speed (RPM), Accelerator pedal position
Sensors	Accelerometer
Scenarios	Green Driving , Over Speeding detection , Jamming detection , GNSS Fuel Counter , DOUT Control Via Call , Excessive Idling detection , Immobilizer , iButton Read Notification , Unplug detection , Towing detection , Crash detection , Auto Geofence , Manual Geofence , Trip
Sleep modes	GPS Sleep , Online Deep Sleep , Deep Sleep , Ultra Deep Sleep
Configuration and firmware update	FOTA Web , FOTA , Teltonika Configurator (USB, Bluetooth), FMBT mobile application (Configuration)
SMS	Configuration, Events, DOUT control, Debug
GPRS commands	Configuration, DOUT control, Debug
Time Synchronization	GPS, NITZ, NTP
Ignition detection	Digital Input 1, Accelerometer, External Power Voltage, Engine

Electrical characteristics

Table 7 Electrical characteristics

CHARACTERISTIC DESCRIPTION	VALUE			
	MIN.	TYP.	MAX.	UNIT
SUPPLY VOLTAGE				
Supply Voltage (Recommended Operating Conditions)	+10		+30	V
DIGITAL OUTPUT (OPEN DRAIN GRADE)				
Drain current (Digital Output OFF)			120	μA
Drain current (Digital Output ON, Recommended Operating Conditions)		0.1	0.5	A
Static Drain-Source resistance (Digital Output ON)		400	600	mΩ
DIGITAL INPUT				
Input resistance (DIN1)	47			kΩ
Input resistance (DIN2)	38.45			kΩ
Input resistance (DIN3)	150			kΩ
Input voltage (Recommended Operating Conditions)	0		Supply voltage	V
Input Voltage threshold (DIN1)		7.5		V
Input Voltage threshold (DIN2)		2.5		V
Input Voltage threshold (DIN3)		2.5		V

ANALOG INPUT				
Input voltage (Recommended Operating Conditions), Range 1	0		+10	V
Input resistance, Range 1		38.45		kΩ
Measurement error on 12V, Range 1		0.9		%
Additional error on 12 V, Range 1		108		mV
Measurement error on 30 V, Range 1		0.33		%
Additional error on 30 V, Range 1		88		mV
Input Voltage (Recommended Operating Conditions), Range 2	0		+30	V
Input resistance, Range 2		150		kΩ
Measurement error on 12 V, Range 2		0.9		%
Additional error on 12 V, Range 2		108		mV
Measurement error on 30 V, Range 2		0.33		%
Additional error on 30 V, Range 2		88		mV
OUTPUT SUPPLY VOLTAGE 1-WIRE				
Supply voltage	+4.5		+4.7	V
Output inner resistance		7		Ω
Output current ($U_{out} > 3.0$ V)		30		mA
Short circuit current ($U_{out} = 0$)		75		mA

NEGATIVE INPUT

Input resistance	38.45			kΩ
Input voltage (Recommended Operating Conditions)	0		Supply voltage	V
Input voltage threshold		0.5		V
Sink current			180	nA

CAN INTERFACE

Internal terminal resistors CAN bus (no internal termination resistors)				Ω
Differential input resistance	19	30	52	kΩ
Recessive output voltage	2	2.5	3	V
Differential receiver threshold voltage	0.5	0.7	0.9	V
Common mode input voltage	-30		30	V

130.com.ua

Safety information

This message contains information on how to operate FMB140 safely. By following these requirements and recommendations, you will avoid dangerous situations. You must read these instructions carefully and follow them strictly before operating the device!

- The device uses SELV limited power source. The nominal voltage is +12 V DC. The allowed voltage range is +10..+30 V DC.
- To avoid mechanical damage, it is advised to transport the device in an impact-proof package. Before usage, the device should be placed so that its LED indicators are visible. They show the status of device operation.
- When connecting the 2x6 connector wires to the vehicle, the appropriate jumpers of the vehicle power supply should be disconnected.
- Before unmounting the device from the vehicle, the 2x6 connector must be disconnected. The device is designed to be mounted in a zone of limited access, which is inaccessible to the operator. All related devices must meet the requirements of EN 62368-1 standard. The device FMB140 is not designed as a navigational device for boats.



Do not disassemble the device. If the device is damaged, the power supply cables are not isolated or the isolation is damaged, DO NOT touch the device before unplugging the power supply.



All wireless data transferring devices produce interference that may affect other devices which are placed nearby.



The device must be connected only by qualified personnel.



The device must be firmly fastened in a predefined location.



The programming must be performed using a PC with autonomic power supply.



Installation and/or handling during a lightning storm is prohibited.



The device is susceptible to water and humidity.



CAUTION: Risk of explosion if battery is replaced by an incorrect type. Dispose of used batteries according to the instructions.



Battery should not be disposed of with general household waste. Bring damaged or worn-out batteries to your local recycling center or dispose them to battery recycle bin found in stores.



Certification and Approvals

- [FMB140 RoHS](#)

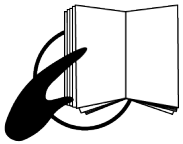

This sign on the package means that it is necessary to read the User's Manual before your start using the device. Full User's Manual version can be found in our [Wiki](#).



This sign on the package means that all used electronic and electric equipment should not be mixed with general household waste.



Hereby, Teltonika declare under our sole responsibility that the above described product is in conformity with the relevant Community harmonization: European Directive 2014/53/EU (RED).

Warranty

TELTONIKA guarantees its products to be free of any manufacturing defects for a period of **24 months**. With additional agreement we can agree on a different warranty period, for more detailed information please contact our sales manager.

Contact us teltonika.lt/company/contacts

All batteries carry a reduced 6 month warranty period.

If a product should fail within this specific warranty time, the product can be:

- Repaired
- Replaced with a new product
- Replaced with an equivalent repaired product fulfilling the same functionality
- TELTONIKA can also repair products that are out of warranty at an agreed cost.

Warranty Disclaimer

TELTONIKA PRODUCTS ARE INTENDED TO BE USED BY PERSONS WITH TRAINING AND EXPERIENCE. ANY OTHER USE RENDERS THE LIMITED WARRANTIES EXPRESSED HEREIN AND ALL IMPLIED WARRANTIES NULL AND VOID AND SAME ARE HEREBY EXCLUDED. ALSO EXCLUDED FROM THIS LIMITED WARRANTY ARE ANY AND ALL INCIDENTAL OR CONSEQUENTIAL DAMAGES INCLUDING BUT NOT LIMITED TO, LOSS OF USE OR REVENUE, LOSS OF TIME, INCONVENIENCE OR ANY OTHER ECONOMIC LOSS.

More information can be found at teltonika.lt/warranty-repair