



PHONES

0 (800) 800 130  
(050) 462 0 130  
(063) 462 0 130  
(067) 462 0 130

130  
COM.UA

Internet store of  
autogoods



SKYPE

km-130

CAR RECEIVERS — Receivers • Media receivers and stations • Native receivers • CD/DVD changers • FM-modulators/USB adapters • Flash memory • Facia plates and adapters • Antennas • Accessories |  
 CAR AUDIO — Car audio speakers • Amplifiers • Subwoofers • Processors • Crossovers • Headphones • Accessories | TRIP COMPUTERS — Universal computers • Model computers • Accessories |  
 GPS NAVIGATORS — Portable GPS • Built-in GPS • GPS modules • GPS trackers • Antennas for GPS navigators • Accessories | VIDEO — DVR • TV sets and monitors • Car TV tuners • Cameras • Videomodules  
 • Transcoders • Car TV antennas • Accessories | SECURITY SYSTEMS — Car alarms • Bike alarms • Mechanical blockers • Immobilizers • Sensors • Accessories | OPTIC AND LIGHT — Xenon • Bixenon • Lamps  
 • LED • Stroboscopes • Optic and Headlights • Washers • Light, rain sensors • Accessories | PARKTRONICS AND MIRRORS — Rear parktronic • Front parktronic • Combined parktronic • Rear-view mirrors  
 • Accessories | HEATING AND COOLING — Seat heaters • Mirrors heaters • Screen-wipers heaters • Engine heaters • Auto-refrigerators • Air conditioning units • Accessories | TUNING — Vibro-isolation  
 • Noise-isolation • Tint films • Accessories | ACCESSORIES — Radar-detectors • Handsfree, Bluetooth • Windowlifters • Compressors • Beeps, loudspeakers • Measuring instruments • Cleaners • Car seats  
 • Miscellaneous | MOUNTING — Installation kits • Upholstery • Grilles • Tubes • Cable and wire • Tools • Miscellaneous | POWER — Batteries • Converters • Start-charging equipment • Capacitors  
 • Accessories | MARINE AUDIO AND ELECTRONICS — Marine receivers • Marine audio speakers • Marine subwoofers • Marine amplifiers • Accessories | CAR CARE PRODUCTS — Additives • Washer fluid •  
 Care accessories • Car polish • Flavors • Adhesives and sealants | LIQUID AND OIL — Motor oil • Transmission oil • Brake fluid • Antifreeze • Technical lubricant



In store "130" you can find and buy almost all necessary goods for your auto in Kyiv and other cities, delivery by ground and postal services. Our experienced consultants will provide you with exhaustive information and help you to choose the very particular thing. We are waiting for you at the address

<https://130.com.ua>



# R3000iS/R3000iE

**SILENT INVERTER GASOLINE ENGINE GENERATOR**

## **Owner's Manual**

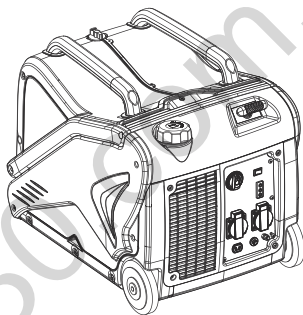

**CHONGQING RATO TECHNOLOGY CO., Ltd.**

130.com.ua

Thank you for choosing a silent inverter gasoline engine generator set of our company.

This manual contains the information on how to do that. Please read it carefully before operating. Operating safely and correctly can help you get the best results.

All information in this publication is based on the latest product information available at the time of printing. The contents in this manual may be different from the actual parts due to revision and other changes.

Our company reserves the right to make changes at any time without notice and without incurring any obligation. No part of this publication may be reproduced without our company's written permission.

This manual should be considered a permanent part of the generator and should accompany the generator if it is resold.

# SAFETY WARNINGS

Personal safety and property safety of you and others are very important. .  
Please read these messages which is preceded by a symbol  or **NOTICE** carefully.

## DANGER

You **WILL** be **KILLED** or **SERIOUSLY HURT** if you don't follow instructions.

## WARNING

You **CAN** be **KILLED** or **SERIOUSLY HURT** if you don't follow instructions.

## CAUTION

You **CAN** be **HURT** if you don't follow instructions.

## **NOTICE**

Your generator or other property could be damaged if you don't follow instructions.

# CONTENTS

SAFETY WARNINGS.....	2
1. SAFETY INFORMATION.....	5
2. LOCATION OF IMPORTANT LABELS.....	9
3. DESCRIPTION.....	10
3.1 Control panel.....	11
4. CONTROL FUNCTION.....	12
4.1 3 in 1 switch knob.....	12
4.2 Oil warning light (red).....	12
4.3 Overload indicator light (Red).....	13
4.4 AC pilot light (Green).....	13
4.5 DC protector.....	14
4.6 Engine smart control (ESC).....	14
4.7 Fuel tank cap.....	15
4.8 Fuel tank cap air vent knob.....	15
4.9 Ground (Earth) terminal.....	15
5. PREPARATION.....	16
5.1 fuel.....	16
5.2 Engine oil.....	17
5.3 Pre-operation check.....	18
6. OPERATION.....	19
6.1 Starting the engine.....	20
6.2 Stopping the engine.....	21
6.3 Alternating Current (AC) connection.....	22
6.4 Battery Charging.....	23
6.5 Application range.....	25

7. MAINTENANCE..... 27

- 7.1 Spark plug inspection..... 29
- 7.2 Carburetor adjustment..... 30
- 7.3 Engine oil replacement..... 30
- 7.4 Air filter..... 31
- 7.5 Muffler screen and spark Arrester..... 32
- 7.6 Fuel tank filter..... 33
- 7.7 Fuel filter..... 33

8. STORAGE..... 34

- 8.1 Drain the fuel..... 34
- 8.2 Engine..... 35

9. TROUBLESHOOTING..... 36

- 9.1 Engine won't start..... 36
- 9.2 Generator won't produce power..... 36

10. SPECIFICATIONS..... 37

11. WIRING DIAGRAM..... 38

# 1. SAFETY INFORMATION

Read and understand this owner's manual before operating your generator. It will help you avoid accidents if you get familiar with your generator's safe operation procedures.

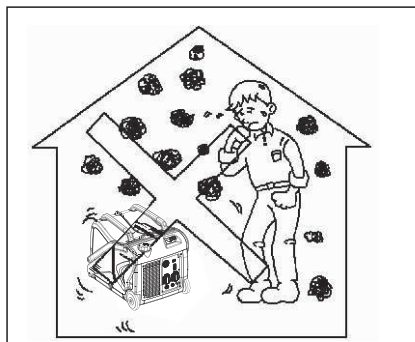

Never use it indoors



Never use it in a wet condition

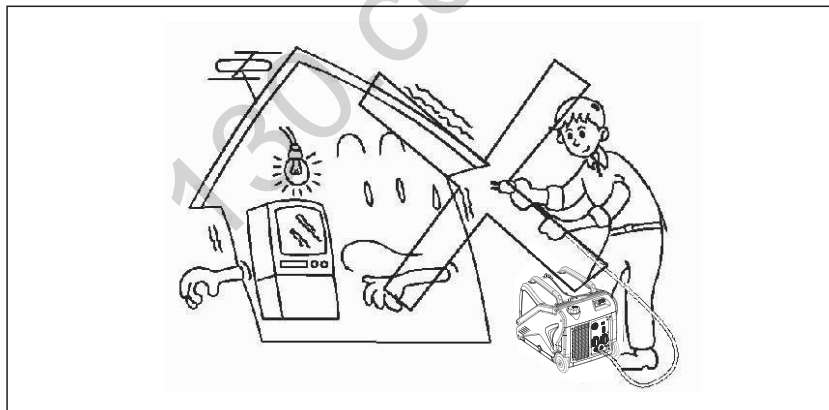

Never directly connect it to a home power system  
Keep out of children



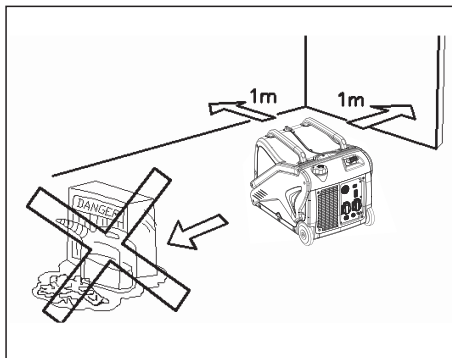

Keep it at least 1m away from  
inflammables

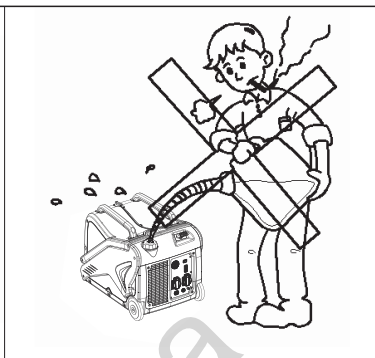

Never smoke when fueling

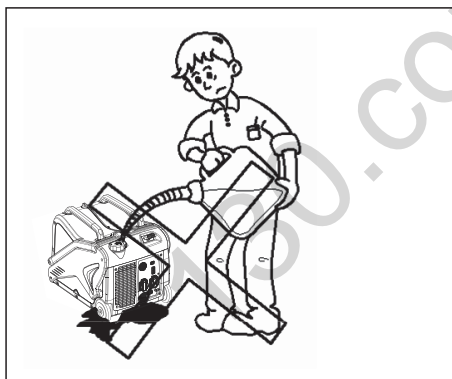

Don't spill when fueling

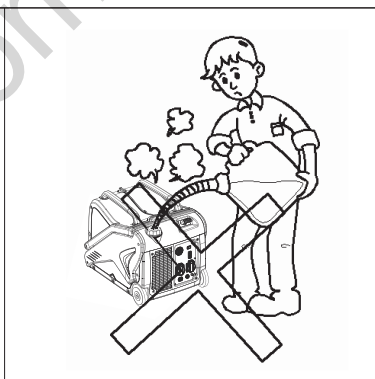

Stop the engine before fueling

## Connections to a Home Power Supply

### NOTICE

If the generator is to be connected to a home power supply as a standby, connection shall be performed by a professional electrician or by another person with proficient electrical skill.

When the loads are connected to the generator, please carefully check whether electrical connections are safe and reliable. Any improper connection may cause damage to the generator, or cause a fire.

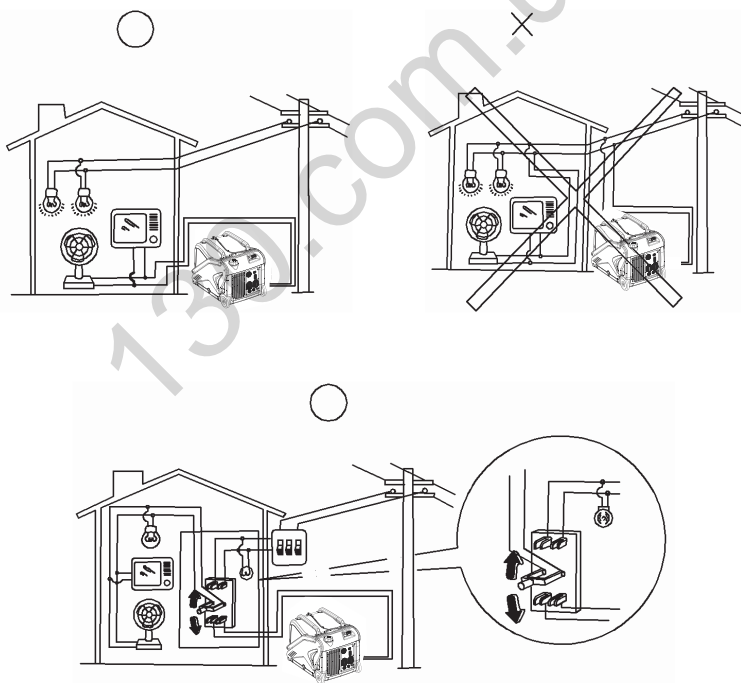

## Generator Ground Circuit

In order to prevent electric shock due to shoddy electrical appliances or wrong use of electricity, the generator must be grounded with a good-quality insulated conductor.

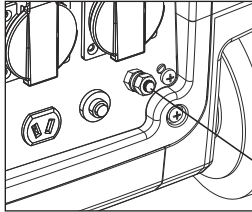

Ground terminal

### NOTICE

Make sure the control panel, louver and the inverter bottom side cooling well and without chips, mud and water come in. it may damage the engine, inverter or alternator if the cooling vent blocked.



Do not mix the generator with other stuff If moving, storing or running the unit.

It may cause the generator damage or bring property safety issue when the generator in leakage.

## 2. LOCATION OF IMPORTANT LABELS

Please read the following labels carefully before operation this machine.

TIP : Maintain or replace safety and instruction labels, as necessary.

①																																					
②																																					
③	<table border="1" style="width: 100%;"> <thead> <tr> <th colspan="2">Silent Inverter Gasoline Engine Generator</th> <th colspan="2">Silent Inverter Gasoline Engine Generator</th> </tr> <tr> <th colspan="2">Low power generator set</th> <th colspan="2">Low power generator set</th> </tr> </thead> <tbody> <tr> <td>Type:</td> <td>R1300SE Performance class: G2</td> <td>Type:</td> <td>R1300SE Performance class: G2</td> </tr> <tr> <td>Rated power/MP:</td> <td>2.8kW Output class: Class B</td> <td>Rated power/MP:</td> <td>2.8kW Output class: Class B</td> </tr> <tr> <td>Rated voltage:</td> <td>230V Rated power factor: 1</td> <td>Rated voltage:</td> <td>230V Rated power factor: 1</td> </tr> <tr> <td>Rated current:</td> <td>12A Weight: 23kg</td> <td>Rated current:</td> <td>12A Weight: 23kg</td> </tr> <tr> <td>Rated frequency:</td> <td>50Hz Total of connections: 20/16</td> <td>Rated frequency:</td> <td>50Hz Total of connections: 20/16</td> </tr> <tr> <td colspan="2">Serial number: The number is printed on the crankcase.</td> <td colspan="2">Serial number: The number is printed on the crankcase.</td> </tr> <tr> <td colspan="2">CHONGQING RATO POWER MANUFACTURING CORPORATION Chongqing RATO Power Park, Changshu District, Chongqing, P.R. China</td> <td colspan="2">CHONGQING RATO POWER MANUFACTURING CORPORATION Chongqing RATO Power Park, Changshu District, Chongqing, P.R. China</td> </tr> </tbody> </table>	Silent Inverter Gasoline Engine Generator		Silent Inverter Gasoline Engine Generator		Low power generator set		Low power generator set		Type:	R1300SE Performance class: G2	Type:	R1300SE Performance class: G2	Rated power/MP:	2.8kW Output class: Class B	Rated power/MP:	2.8kW Output class: Class B	Rated voltage:	230V Rated power factor: 1	Rated voltage:	230V Rated power factor: 1	Rated current:	12A Weight: 23kg	Rated current:	12A Weight: 23kg	Rated frequency:	50Hz Total of connections: 20/16	Rated frequency:	50Hz Total of connections: 20/16	Serial number: The number is printed on the crankcase.		Serial number: The number is printed on the crankcase.		CHONGQING RATO POWER MANUFACTURING CORPORATION Chongqing RATO Power Park, Changshu District, Chongqing, P.R. China		CHONGQING RATO POWER MANUFACTURING CORPORATION Chongqing RATO Power Park, Changshu District, Chongqing, P.R. China	
Silent Inverter Gasoline Engine Generator		Silent Inverter Gasoline Engine Generator																																			
Low power generator set		Low power generator set																																			
Type:	R1300SE Performance class: G2	Type:	R1300SE Performance class: G2																																		
Rated power/MP:	2.8kW Output class: Class B	Rated power/MP:	2.8kW Output class: Class B																																		
Rated voltage:	230V Rated power factor: 1	Rated voltage:	230V Rated power factor: 1																																		
Rated current:	12A Weight: 23kg	Rated current:	12A Weight: 23kg																																		
Rated frequency:	50Hz Total of connections: 20/16	Rated frequency:	50Hz Total of connections: 20/16																																		
Serial number: The number is printed on the crankcase.		Serial number: The number is printed on the crankcase.																																			
CHONGQING RATO POWER MANUFACTURING CORPORATION Chongqing RATO Power Park, Changshu District, Chongqing, P.R. China		CHONGQING RATO POWER MANUFACTURING CORPORATION Chongqing RATO Power Park, Changshu District, Chongqing, P.R. China																																			

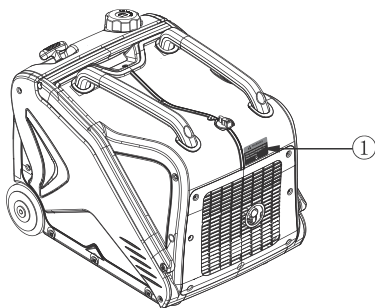
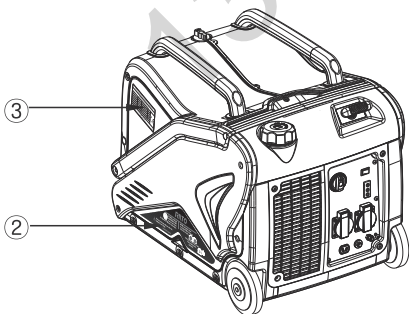

### 3. DISCRPTION

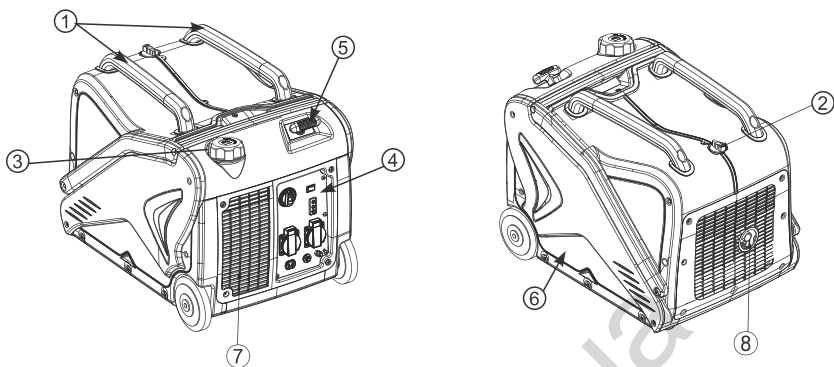

- ① Carrying handle
- ② Knob
- ③ Fuel tank cap
- ④ Control panel
- ⑤ Recoil starter
- ⑥ Oil filler cap
- ⑦ Louver
- ⑧ Muffler

### 3.1 Control panel

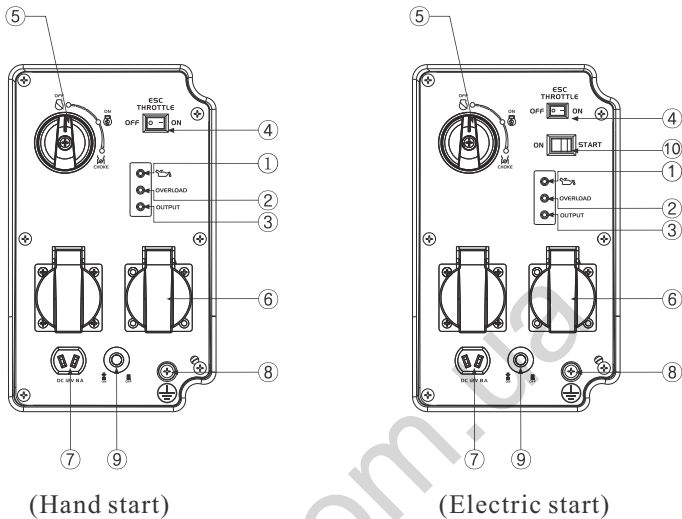

- ① Oil warning light
- ② Overload indicator light
- ③ AC pilot light
- ④ ESC(Engine Smart Control)
- ⑤ 3 in 1 switch knob (including start/stop switch, fuel valve and choke)
- ⑥ AC receptacle
- ⑦ DC receptacle
- ⑧ Ground (earth) terminal
- ⑨ DC protector
- ⑩ Engine switch

## 4. CONTROL FUNCTION

### 4.1 3 in 1 switch knob for 3000is

(Hand start)

- ① Engine switch \fuel valve  “OFF”;  
Ignition circuit is switched off. Fuel is switched off.

The engine will not run.

- ② Engine switch \fuel valve \ choke  “ON”;

Ignition circuit is switched on. Fuel is switched on. Choke is switched on.

The engine can be running.

- ③ Engine switch \fuel valve \ chock  “CHOKE”;

Ignition circuit is switched on. Fuel is switched on. Choke is switched off.

The engine can be start.

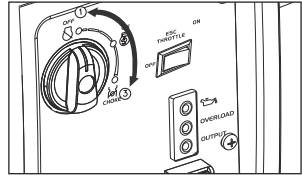

(Electric start)

- ① Engine switch \fuel valve  “OFF”;  
Ignition circuit is switched off. Fuel is switched off.

The engine will not run.

- ② Engine switch \fuel valve \ choke  “ON”;

Ignition circuit is switched on. Fuel is switched on. Choke is switched on.

The engine can be running.

- ③ Engine switch \fuel valve \ chock  “CHOKE”;

Ignition circuit is switched on. Fuel is switched on. Choke is switched off.

The engine can be start.

- ④ Engine switch "START"

It is used the instant for start (only for R3000IE).

- ⑤ Engine switch "ON"

The engine will not run (only for R3000IE).

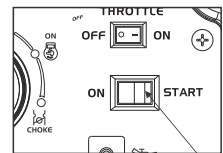

START

**TIP:** The choke “” is not required to start a warm engine.

## 4.2 Oil warning light (red)

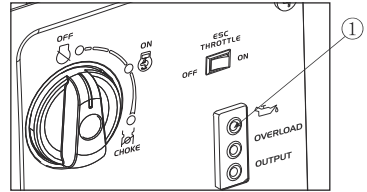

When the oil level falls below the lower level, the oil warning light ① comes on and then the engine stops automatically. Unless you refill with oil, the engine will not start again.

**Tip:** If the engine stalls or does not start, turn the engine switch to “ON” and then pull the recoil starter.

If the oil warning light flickers for a few seconds, the engine oil is insufficient. Add oil and restart.

## 4.3 Overload indicator light (Red)

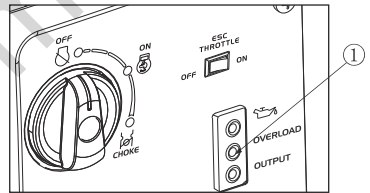

The overload indicator light ① comes on when an overload of a connected electrical device is detected, the inverter control unit overheats, or the AC output voltage rises. Then, the AC protector will trip, stopping power generation in order to protect the generator and any connected electric devices. The AC pilot light (Green) will go off and the overload indicator light (Red) will stay on, but the engine will not stop running.

When the overload indicator light comes on and power generation stops, proceed as follows:

1. Turn off any connected electric devices and stop the engine.
2. Reduce the total wattage of connected electric devices within the rated output.



3. Check for blockages in the cooling air inlet and around the control unit.  
If any blockages are found, remove.
4. After checking, restart the engine.

**Tip:** The overload indicator light may come on for a few seconds at first when using electric devices that require a large starting current, such as a compressor or a submergible pump. However, this is not a malfunction.

#### 4.4 AC pilot light (Green)

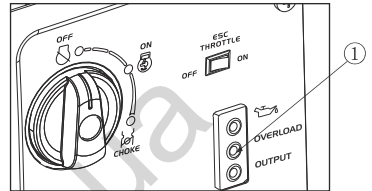

The AC pilot light ① comes on when the engine starts and produces power.

#### 4.5 DC protector

The DC protector turns to “OFF” ② automatically when electric device being connected to the generator is operating and current above the rated flows. To use this equipment again, turn on DC protector by pressing its button to “ON” ①

① “ON”

Direct current is output.

② “OFF”

Direct current is not output.

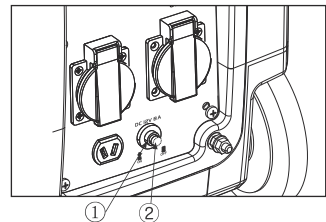

Reduce the load of the connected electric device below the specified rated output of the generator if the DC protector turns off. If the DC protector turns off again, stop using the device immediately and consult our company authorized dealer.

## 4.6 Engine smart control (ESC)

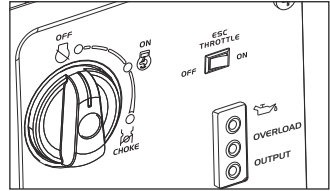

### ① “ON”

When the ESC switch is turned to “ON”, the economy control unit controls the engine speed according to the connected load. The results are better fuel consumption and less noise.

### ② “OFF”

When the ESC switch is turned to “OFF”, the engine runs at the rated r/min(3600r/min) regard-less of whether is a load connected or not.

### Tip:

The ESC must be turned to “OFF” when using electric devices that require a large starting current, such as a compressor of a submergible pump.

## 4.7 Fuel tank cap

Remove the fuel tank cap by turning it counterclockwise.

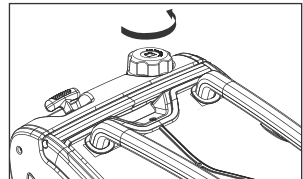

## 4.8 Ground (Earth) terminal

Ground (Earth) terminal ① connects the earth line for prevention of electric shock.

When the electric device is earthed, always the generator must be earthed.

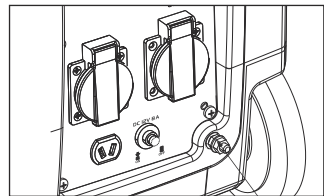

## 5. PREPARATION

### 5.1 Fuel

#### **⚠ DANGER**

- Fuel is highly flammable and poisonous. Check “SAFETY INFORMATION” carefully before filling.
- Do not overfill the fuel tank, otherwise it may overflow when the fuel warms up and expands.
- After fill the fuel, make sure the fuel tank cap is tightened securely.



#### **NOTICE**

- Immediately wipe off spilled fuel with a clean, dry, soft cloth, since fuel may deteriorate painted surfaces or plastic parts.
- Use only unleaded gasoline. The use of leaded gasoline will cause severe damage to internal engine parts.

Remove the fuel tank cap and fill the fuel into the tank up to the red level.

- ① Red line
- ② Fuel level

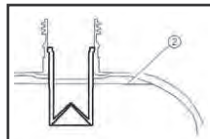
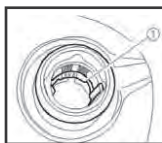

Recommended fuel:

Unleaded gasoline

Fuel tank capacity:

Total: 7L

## 5.2 Engine oil

### NOTICE

The generator has been shipped without engine oil. Do not start the engine till fill with the sufficient engine oil.

1. Place the generator on a level surface.
2. Remove the screws ①, and then remove the cover ②.
3. Remove the oil filler cap ③.

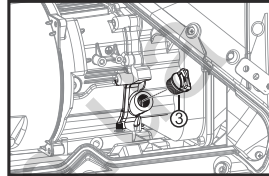
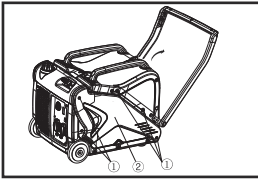

4. Fill the specified amount of the recommended engine oil, and then install and tighten the oil filler cap.
5. Install the cover and tighten the screws.

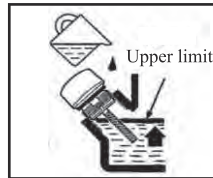
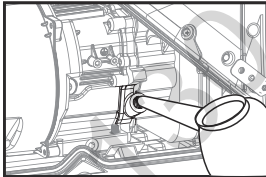

Recommended engine oil: SAE SJ 10W-40

Recommended engine oil grade: API Service SJ type or higher

Engine oil quantity: 0.5 L

## 5.3 PRE-OPERATION CHECK



If any item in the Pre-operation check is not working properly, have it inspected and repaired before operating the generator.

The condition of a generator is the owner's responsibility. Vital components can start to deteriorate quickly and unexpectedly, even if the generator unused.

**TIP:** Pre-operation checks should be made each time the generator is used.

### Pre-operation check

#### Fuel (See page 16)

- Check fuel level in fuel tank.
- Refuel if necessary.

#### Engine oil (See page 17)

- Check oil level in engine.
- If necessary, add recommended oil to specified level.
- Check generator for oil leakage.

#### The point where abnormality was recognized by use

- Check operation.
- If necessary, add recommended oil to specified level.
- If necessary, consult our company authorized dealer.

## 6. OPERATION

### WARNING

- Never operate the engine in a closed area or it may cause unconsciousness and death within a short time. Operate the engine in a well ventilated area.
- Before starting the engine, do not connect any electric devices.

### NOTICE

- The generator has been shipped without engine oil. Do not start the engine till fill with the sufficient engine oil.
- Do not tilt the generator when adding engine oil. This could result in overfilling and damage to the engine.

### TIP:

The generator can be used with the rated output load at standard atmospheric conditions.

“Standard atmospheric conditions”

Ambient temperature 25°C

Barometric pressure 100kPa

Relative humidity 30%

The output of the generator varies due to change temperature, altitude (lower air pressure at higher altitude) and humidity.

The output of the generator is reduced when the temperature, the humidity and the altitude are higher than standard atmospheric conditions.

Additionally, the load must be reduced when using in a confined areas, as generator cooling is affected.

## 6.1 Starting the engine

(Hand start)

1. Turn the ESC switch to “OFF” ①.

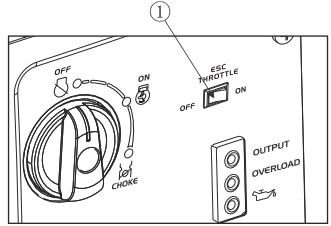

2. Turn the 3 in 1 switch to “CHOKE” ③,

- a. Ignition circuit is switched on.
- b. Fuel is switched on.
- c. chock is switched off

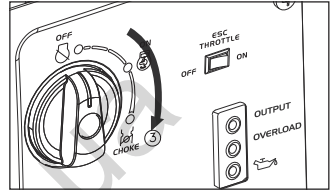

**TIP:** The choke is not required to start a

warm engine. Push the choke knob in to the position ② “ON”.

3. Pull slowly on the recoil starter until it is engaged, then pull it briskly.

**TIP:** Grasp the carrying handle firmly to prevent the generator from falling over when pulling the recoil starter.

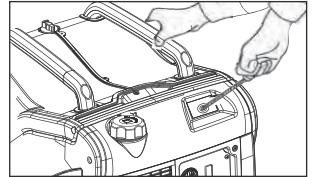

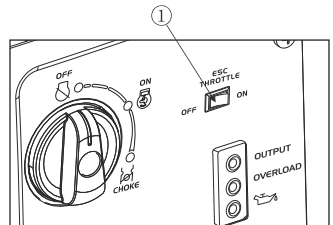

(Electric start)

1. Turn the ESC switch to “OFF” ①.

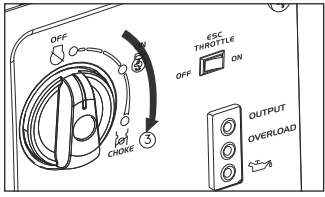

2. Turn the 3 in 1 switch to  "CHOKE" ③,
  - a. Ignition circuit is switched on.
  - b. Fuel is switched on.
  - c. chock is switched off



**TIP:** The choke is not required to start a warm engine. Push the choke knob in to the position  "ON".

3. Press the engine switch to "START".  
the engine can be start.

**TIP:** When starting the engine, it will be automatic reset to "ON"

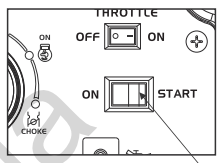

START

4. After the engine starts, warm up the engine until the engine does not stop when the choke knob is returned to the  "ON" position ④.

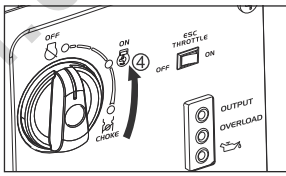

**TIP:** When starting the engine, with the ESC "ON", and there is no load on the generator:

- In ambient temperature below 0°C(32°F), the engine will run at the rated r/min (4500r/min) for 5 minutes to warm up the engine.
- In ambient temperature below 5°C(41°F), the engine will run at the rated r/min (4500r/min) for 3 minutes to warm up the engine.
- The ESC unit operates normally after the above time period, while the ESC is "ON".

## 6.2 Stopping the engine

**TIP:** Turn off any electric devices.

1. Turn the ESC to "OFF" ①.

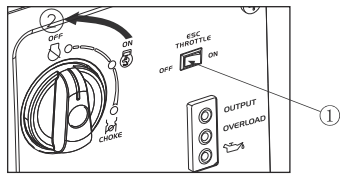



2. Disconnect any electric devices.

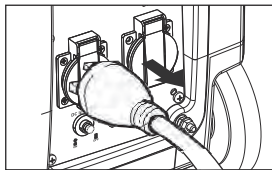

3. Turn the 3 in 1 switch to  “OFF” ②,

a. Ignition circuit is switched off.

b. Fuel is switched off.

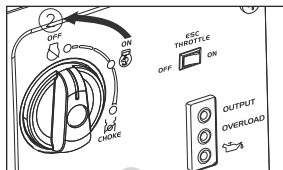

### 6.3 Alternating Current (AC) connection

#### WARNING

Be sure any electric devices are turned off before plugging them in.

#### NOTICE

- Be sure all electric devices including the lines and plug connections are in good condition before connection to the generator.
- Be sure the total load is within generator rated output.
- Be sure the receptacle load current is within receptacle rated current.
- The generator (STATOR WINDING) is isolated from the AC receptacle ground pin.
- Electrical devices that require a grounded receptacle pin connection will not function if the receptacle ground pin is not functional.

**TIP:** Make sure to ground (Earth) the generator. When the electric device is earthed, always the generator must be earthed.

1. Start the engine.
2. Turn the ESC to “ON”.
3. Plug in to AC receptacle.
4. Make sure the AC pilot light is on.
5. Turn on any electric devices.

**TIP:** The ESC must be turned to “OFF” to increase engine speed to rated rpm. If the generator is connected to multiple loads or electricity consumers, please remember to first connect the one with the highest starting current. and last connect the one with the lowest starting current.

## 6.4 Battery Charging

**Battery Model:** 6DM7

Battery Type: Free maintained lithium battery

Capacity: 6.5Ah

Method of replacement the battery

1. Remove the cover and then pull outward on the areas of the cover.
2. Loosen the bolt ②.
3. Remove the bracket ③.
4. Take out the battery ④.

**TIP:**

- The generator DC rated voltage is 12V.
  - Start the engine first, and then connect the generator to the battery for charging.
  - Before starting to charge the battery, make sure that the DC protector is turned on.
1. Start the engine.
  2. Connect the red battery charger lead to the positive (+) battery terminal.

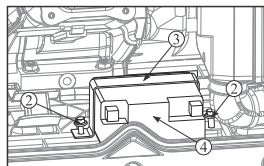
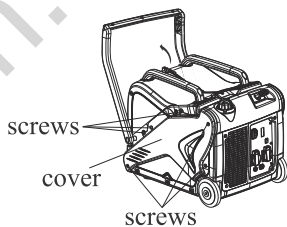

3. Connect the black battery charger lead to the negative (-) battery terminal.
4. Turn the ESC “off” to start battery charging.

#### **NOTICE**

- Be sure the ESC is turned off while charging the battery.
- The battery is no need to maintenance. After the power of the battery is consumed, do not throw the battery into the dustbin and take it to the location service organization.
- If you do not plan to use the machine for a long period of time, it is a good idea to disconnect the negative battery cable from the battery for storage. After disconnecting the cable, cover the free end with an insulator such as electrical tape
- Be sure to connect the red battery charger lead to the positive (+)battery terminal ,and connect the black lead to the negative (-) battery terminal. Do not reverse these positions.
- Connect the battery charger leads to the battery terminals securely so that they are not disconnected due to engine vibration or other disturbances.
- Charge the battery in the correct procedure by following instructions in the owner’s manual for the battery.
- The DC protector turns off automatically if current above the rated flows during battery charging. To restart charging the battery, turn the DC protector on by pressing its button to “ON”. If the DC protector turns off again, top charging the battery immediately and consult our company authorized dealer.

#### **TIP:**

- Follow instructions in the owner’s manual for the battery to determine the end of battery charging.
- Measure the specific gravity of electrolyte to determine if the battery is fully charged. At full charge, the electrolyte specific gravity is between 1.26 and 1.28.

- It is advisable to check the specific gravity of the electrolyte at least once every hour to prevent overcharging the battery.



**Never smoke or make and break connections at the battery while charging. Sparks may ignite the battery gas.**

**Battery electrolyte is poisonous and dangerous, causing severe burns, etc. contains sulfuric (sulphuric) acid. Avoid contact with skin, eyes or clothing.**

**Antidote:**

**EXTERNAL-** Flush with water.





**INTERNAL-** Drink large quantities of water or milk. Follow with milk of magnesia, beaten egg or vegetable oil . Call physician immediately.

**EYES:** Flush with water for 15 minutes and get prompt medical attention. Batteries produce explosive gases. Keep sparks, flame, cigarettes, etc., away. Ventilate when charging or using in closed space. Always cover eyes when working near batteries.

**KEEP OUT OF REACH OF CHILDREN.**

## 6.5 Application range

When using the generator, make sure the total load is within rated output of a generator. Otherwise, generator damage may occur.

AC				DC 
Power factor	1	0.8–0.95	0.4–0.75 (Efficiency 0.85)	
Rated output power	≤ 28,00W	≤ 2,240W	≤ 1,120W	Rated voltage 12V

**TIP:**

- Application wattage indicates when each device is used by itself.
- The simultaneous usage of AC and DC power is possible but total wattage should not exceed the rated output.

**EX:**

Generator rated output		2, 800W
Frequency	Power factor	
AC	1.0	$\leq 2, 800W$
DC	---	96W (12V/8.3A)

- The overload indicator light ① comes on when total wattage exceeds the application range.

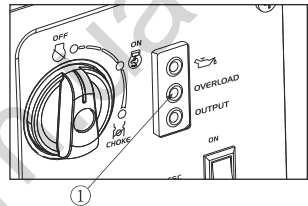

**NOTICE**

- Do not overload. The total load of all electrical appliances must not exceed the supply range of the generator. Overloading will damage the generator.
- When supplying precision equipment, electronic controllers, PCs, Electronic computers, microcomputer based equipment or battery chargers, keep the generator a sufficient distance away to prevent electrical interference from the engine. Also ensure that electrical noise from the engine does not interfere with any other electrical devices located near the generator.
- If the generator is to supply medical equipment, advice should first be obtained from the manufacturer, a medical professional or hospital.
- Some electrical appliances or general-purpose electric motors have High starting currents, and cannot therefore be used, even if they lie within the supply ranges given in the above table. Consult the equipment manufacturer for further advice.

## 7. MAINTENANCE

The engine must be properly maintained to ensure its operation be safe, economy and trouble-free, as well as eco-friendly.

In order to keep your gasoline engine in good working condition, it must be periodically serviced. The following maintenance schedule and routine inspection procedures must be carefully followed:

Items		Frequency	Each time	First 1 month or first 20hrs of operation	Thereafter, every 3 months or every 50hrs of operation	Every year or every 100 hrs of operation	
Engine oil	Check-Refill		✓				
	Replace			✓	✓		
Reduction gear oil(if equipped)	Oil level check		✓				
	Replace			✓	✓		
Air filter element	Check		✓				
	Clean			✓			
	Replace				✓		
Deposit Cup ( if equipped)	Clean					✓	
Spark Plug	Check-adjust					✓	
	Replace	Every year or 250 hrs of operation					
Spark arrester	Clean				✓		
Idling ( if equipped)*	Check-adjust					✓	
Valve clearan- -ce *	Check-adjust					✓	
Fuel tank & fuel filter *	Clean					✓	
Fuel line	Check	Every 2 years( change if necessary)					
Cylinder head, piston	Clean up carb-on *			<225cc, Every 125hrs	≥ 225cc, Every 250hrs		
<p>* These items should be maintained and repaired by our authorized dealer, unless the owner has appropriate tools and is proficient with mechanical maintenance.</p> <p>* The installation and major repair work shall be carried out only by specifically trained personnel.</p>							

## NOTICE

- If the gasoline engine frequently works under high temperature or heavy load, change the oil every 25 hours.
- If the engine frequently work under dusty or other severe circumstances, clean the air filter element every 10 hours; If necessary, change the air filter element every 25 hours.
- The maintenance period and the exact time (hour), the one which comes first should govern.
- If you have missed the scheduled time to maintain your engine, do it as soon as possible.

## WARNING

**Stop the engine before servicing. Put the engine on a level surface and remove the spark plug cap to prevent the engine from starting. Do not operate the engine in a poorly ventilated room or other enclosed area. Be sure to keep good ventilation in working area. The exhaust from the engine may contain poisonous CO, inhalation can cause shock, unconsciousness and even death.**

## 7.1 Spark plug inspection

The spark plug is important engine components, which should be checked periodically.

1. Remove the spark plug cap ②, and Insert the tool ⑤ through the hole from the outside of the cover.

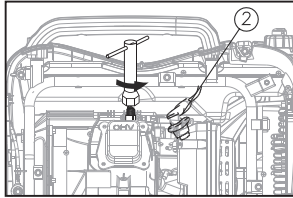

2. Insert the handlebar ④ into the tool ⑤ and turn it counterclockwise to remove the spark plug.
3. Check for discoloration and remove the carbon. The porcelain insulator around the center electrode of spark plug should be a medium-to-light tan color.
4. Check the spark plug type and gap.

Standard Spark Plug: F6RTC  
Spark Plug Gap: 0.7-0.8mm

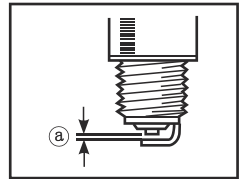

**TIP:** The spark plug gap should be measured with a wire thickness gauge and, if necessary, adjusted to specification.

5. Install the spark plug.

Spark Plug Torque: 28N.m

**TIP:** If a torque wrench is not available when installing a spark plug, a good estimate of the correct torque is 1/4-1/2 turn past finger tight. However, the spark plug should be tightened to the specified torque as soon as possible.

6. Install the spark plug cap and spark plug cover.



## 7.2 Carburetor adjustment

The carburetor is a vital part of the engine. Adjusting should be left to our company authorized dealer with the professional knowledge, specialized date, and equipment to do so properly.

## 7.3 Engine oil replacement

### WARNING

Avoid draining the engine oil immediately after stopping the engine. The oil is hot and should be handled with care to avoid burns.

1. Place the generator on a level surface and warm up the engine for several minutes. The stop the engine and turn the 3 in 1 switch knob, fuel tank cap air vent knob to “OFF”.
2. Remove the screws ① and then remove the cover ②.

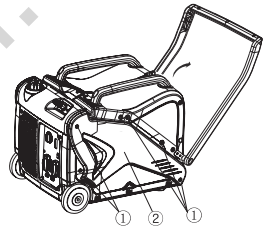

3. Remove the oil filler cap ③.

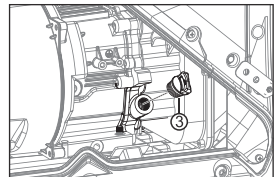

4. Place an oil pan under the engine. Tilt the generator to drain the oil completely.

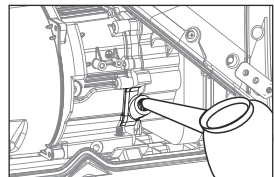

5. Replace the generator on a level surface.

### NOTICE

**Do not tilt the generator when adding engine oil. This could result in overfilling and damage to the engine.**

6. Add engine oil to the upper level.

Recommended engine oil: SAE SJ 10W-40

Recommended engine oil grade: API Service SJ type or higher

Engine oil quantity: 0.5L

7. Wipe the cover clean, and wipe up any spilled oil.

#### NOTICE

**Be sure no foreign material enters the crankcase.**

8. Install the oil filler cap.

9. Install the cover and tighten the screws.

### 7.4 Air filter

1. Remove the screws ①, and then remove the cover ②.

2. Remove the screw ③ and then remove the air filter case cover ④.

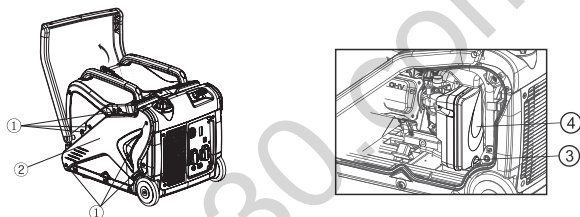

3. Remove the foam element ⑤.

4. Wash the foam element in solvent and dry it.

5. Oil the foam element and squeeze out excess oil.

The foam element should be wet but not dripping.

#### NOTICE

**Do not wring out the foam element when squeezing it. This could cause it to tear.**

6. Insert the foam element into the air filter case.

**TIP:** Be sure the foam element sealing surface matches the air filter so there is no air leak.

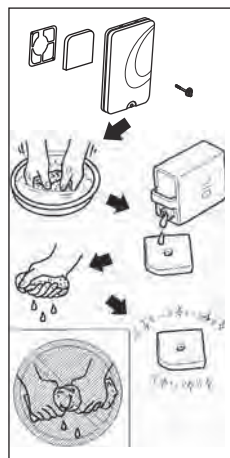

**The engine should never run without the foam element; excessive piston and cylinder wear may result.**

7. Install the air filter case cover in its original position and tighten the screw.
8. Install the cover and tighten the screws.

## 7.5 Muffler screen and spark arrester



**The engine and muffler will be very hot after the engine has been run. Avoid touching the engine and muffler while they are still hot with any part of your body or clothing during inspection or repair.**

1. Remove the screws ①, and then pull outward on the areas of the cover ② shown.

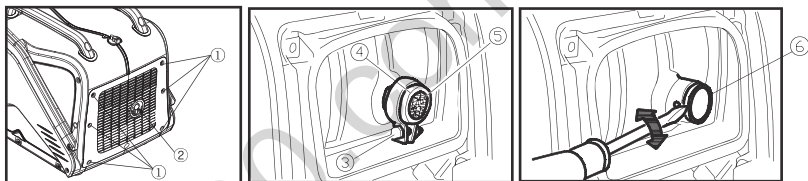

2. Loosen the bolt ③ and then remove the muffler cap ④, the muffler screen ⑤ and spark arrester ⑥.
3. Clean the carbon deposits on the muffler screen and spark arrester using a wire brush.

### NOTICE

**When cleaning, use the wire brush lightly to avoid damaging or scratching of muffler screen and spark arrester.**

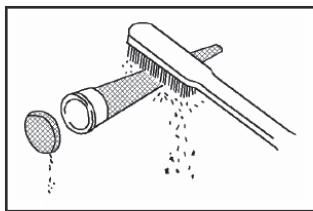

4. Check the muffler screen and spark arrester. Replace them if damaged.
5. Install the spark arrester.

**TIP:**

Align the spark arrester projection ⑦ with the hole ⑧ in the muffler pipe.

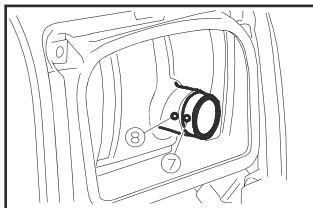

6. Install the muffler screen and the muffler cap.
7. Install the cover and tighten the screws.

## 7.6 Fuel tank filter



**Never use the gasoline while smoking or in the vicinity of an open flame.**

1. Remove the fuel tank cap and filter.
2. Clean the filter with gasoline.
3. Wipe the filter and install it.
4. Install the fuel tank cap.

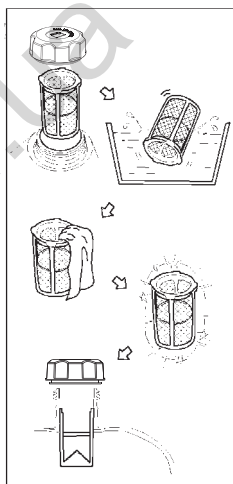

**Be sure the fuel tank cap is tightened securely.**

## 8. STORAGE AND TRANSPORTATION

Long term storage of your machine will require some preventive procedures to guard against deterioration.

### 8.1 Drain the fuel

1. Turn the 3 in 1 switch to “OFF” ①.

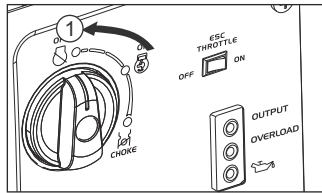

2. Remove the fuel tank cap, remove the filter . Extract the fuel from the fuel tank into an approved gasoline container. Then, install the fuel tank cap.

#### **⚠ WARNING**

**Fuel is highly flammable and poisonous. Check “SAFETY INFORMATION” (See page 5) carefully.**

#### **NOTICE**

**Immediately wipe off spilled fuel with a clean, dry, soft cloth, since fuel may deteriorate painted surfaces or plastic parts.**

3. Start the engine ( See Page 20 ) and leave it run until it stops. The engine stops in approx. 20 minutes. Time by running out of fuel.

#### **TIP:**

- Do not connect with any electrical devices. (unloaded operation)
- Duration of the running engine depends on the amount of the fuel left in the tank.

4. Remove the screws, and then remove the cover.

5. Drain the fuel from the carburetor by loosening the drain screw on the carburetor float chamber.
6. Turn the 3 in 1 switch to “OFF”.
7. Tighten the drain screw.
8. Install the cover and tighten the screws.
9. Turn the fuel tank cap air vent knob to “OFF” after the engine has completely cools down.

## **8.2 Engine**

Perform the following steps to protect the cylinder, piston ring, etc. from corrosion.

1. Remove the spark plug, pour about one table- spoon of SAE 10W-30 into the spark plug hole and reinstall the spark plug. Recoil start the engine by turning over several times (with 3 in 1 switch knob off) to coat the cylinder walls with oil.
2. Pull the recoil starter until you feel compression. Then stop pulling. (This prevents the cylinder and valves from rusting).
3. Clean exterior of the generator. Store the generator in a dry, well-ventilated place, with the cover placed over it.

## 9. TROUBLESHOOTING

### 9.1 Engine won't start

#### 1. Fuel systems

No fuel supplied to combustion chamber.

- No fuel in tank...Supply fuel.
- Fuel in tank....Fuel tank cap air vent knob and fuel cock knob to “ON”
- Clogged fuel filter .... Clean fuel filter.
- Clogged carburetor.... Clean carburetor.

#### 2. Engine oil system

Insufficient

- Oil level is low.... Add engine oil.



#### 3. Electrical systems

- Put the 1 in 3 switch to “CHOKE” and pull the recoil starter ... Poor spark.
- Spark plug dirty with carbon or wet ... Remove carbon or wipe spark plug dry.
- Faulty ignition system ... consult our company authorized dealer.

### 9.2 Generator won't produce power

- Safety device (DC protector) to “OFF”.... Press the DC protector to “ON”.
- The AC pilot light (Green) go off .... Stop the engine, then restart.

## 10. SPECIFICATIONS

	Item	R3000iS/R3000iE
Generator	Type	Silent Inverter
	Rated frequency (Hz)	50
	Rated voltage (V)	230
	Rated output power (kW)	2.8
	Maximum output power (kW)	3
	Power factor	1
	Charging Voltage (DC) (V)	12
	According to Directive 2000/14/EC and 2005/88/EC Guaranteed sound power level: 96dB(A) Measured sound pressure: 74dB(A) K=2dB	
Engine	Engine	R210
	Engine type	Single cylinder, 4-Stroke, forced air cooling, OHV
	Displacement (cc)	212
	Fuel type	Unleaded Gasoline
	Fuel tank capacity (L)	7
	Fuel Consumption(g/(kW·h))	≤395
	Continue Running Time (at rated power) (h)	5
	Oil Capacity (L)	0.5
	Spark Model No.	F6RTC
	Starting mode	Recoil starter
Generator set	Length×Width×Height (mm)	605×432×493
	Net weight (kg)	37



# 11. WIRING DIAGRAM

R3000iS

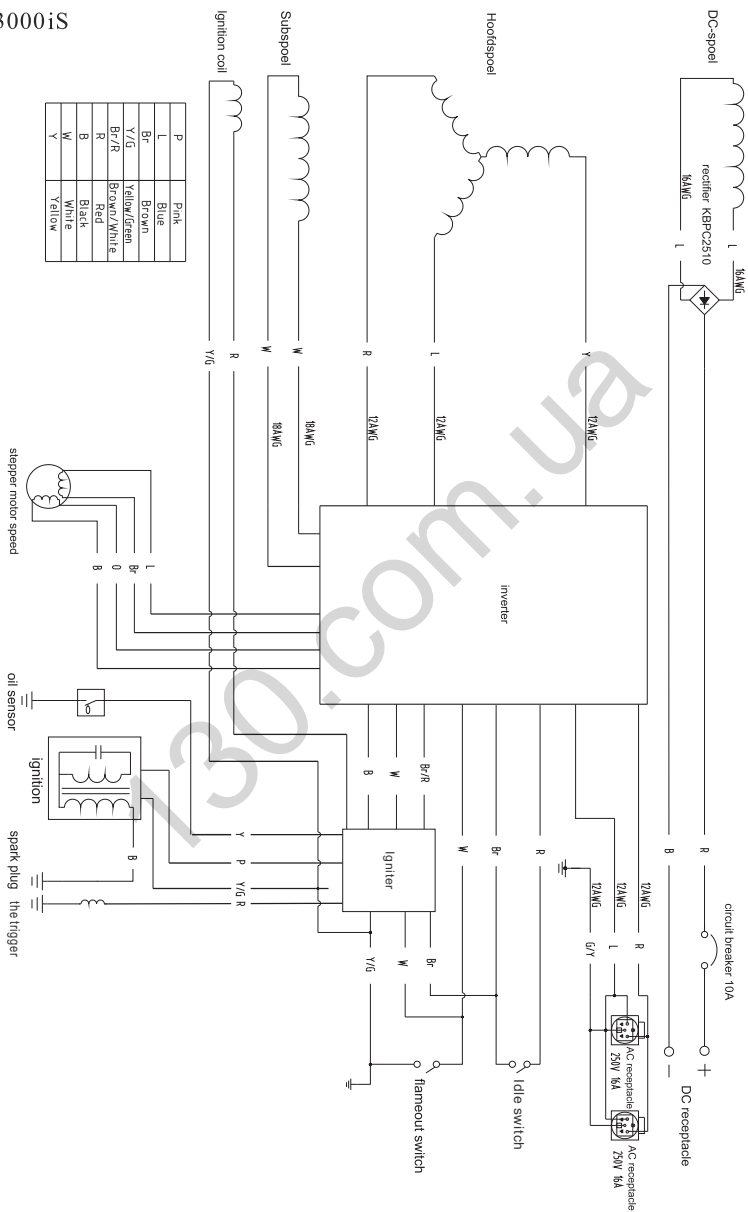

# R3000iE : It Begins running to depend on the start motor

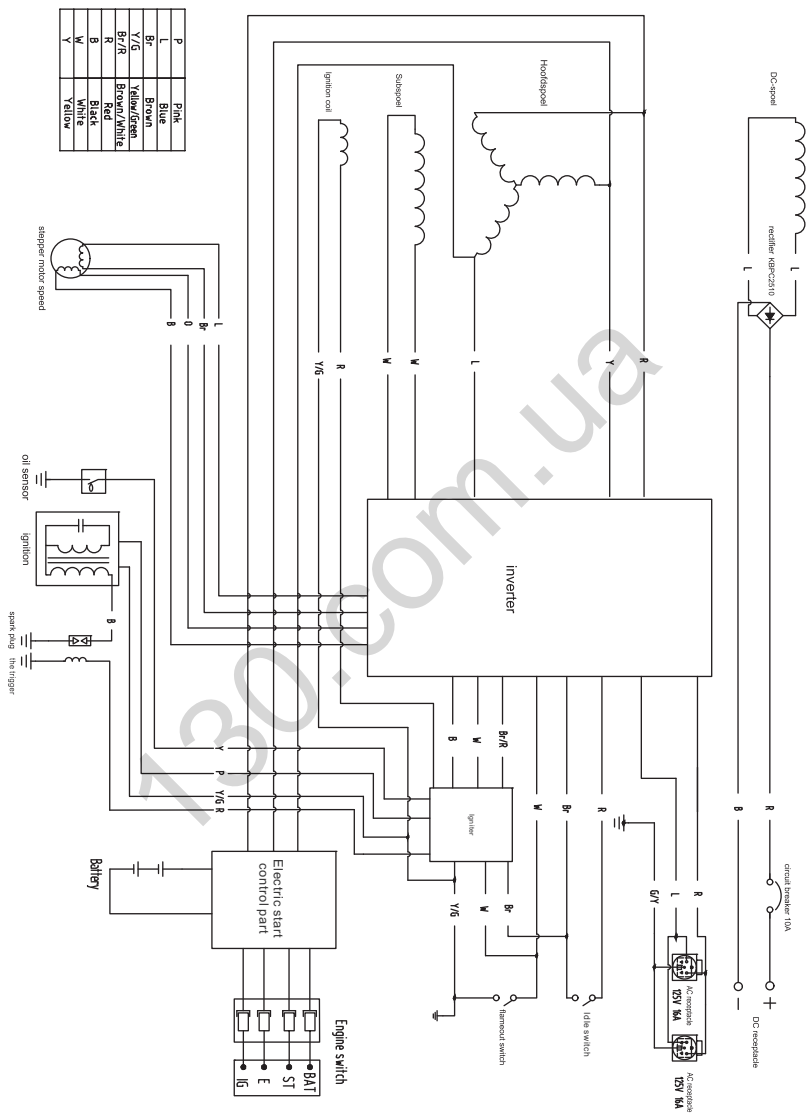

# R3000iE : It Begins running to depend on control parts

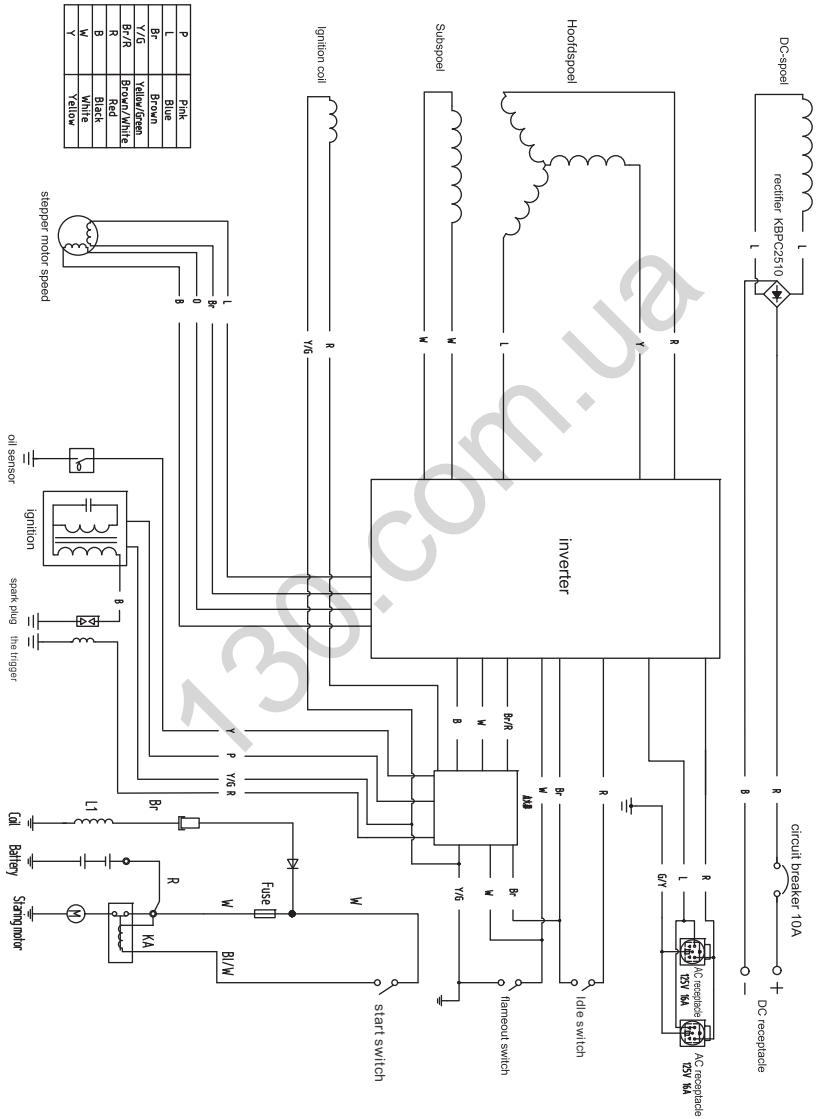

130.com.ua

130.com.ua

93004-Y2P0720-0000

Autogoods "130"