



PHONES

0 (800) 800 130  
(050) 462 0 130  
(063) 462 0 130  
(067) 462 0 130

130  
COM.UA

Internet store of  
autogoods



SKYPE

km-130

CAR RECEIVERS — Receivers • Media receivers and stations • Native receivers • CD/DVD changers • FM-modulators/USB adapters • Flash memory • Facia plates and adapters • Antennas • Accessories |  
 CAR AUDIO — Car audio speakers • Amplifiers • Subwoofers • Processors • Crossovers • Headphones • Accessories | TRIP COMPUTERS — Universal computers • Model computers • Accessories |  
 GPS NAVIGATORS — Portable GPS • Built-in GPS • GPS modules • GPS trackers • Antennas for GPS navigators • Accessories | VIDEO — DVR • TV sets and monitors • Car TV tuners • Cameras • Videomodules  
 • Transcoders • Car TV antennas • Accessories | SECURITY SYSTEMS — Car alarms • Bike alarms • Mechanical blockers • Immobilizers • Sensors • Accessories | OPTIC AND LIGHT — Xenon • Bixenon • Lamps  
 • LED • Stroboscopes • Optic and Headlights • Washers • Light, rain sensors • Accessories | PARKTRONICS AND MIRRORS — Rear parktronic • Front parktronic • Combined parktronic • Rear-view mirrors  
 • Accessories | HEATING AND COOLING — Seat heaters • Mirrors heaters • Screen-wipers heaters • Engine heaters • Auto-refrigerators • Air conditioning units • Accessories | TUNING — Vibro-isolation  
 • Noise-isolation • Tint films • Accessories | ACCESSORIES — Radar-detectors • Handsfree, Bluetooth • Windowlifters • Compressors • Beeps, loudspeakers • Measuring instruments • Cleaners • Car seats  
 • Miscellaneous | MOUNTING — Installation kits • Upholstery • Grilles • Tubes • Cable and wire • Tools • Miscellaneous | POWER — Batteries • Converters • Start-charging equipment • Capacitors  
 • Accessories | MARINE AUDIO AND ELECTRONICS — Marine receivers • Marine audio speakers • Marine subwoofers • Marine amplifiers • Accessories | CAR CARE PRODUCTS — Additives • Washer fluid •  
 Care accessories • Car polish • Flavors • Adhesives and sealants | LIQUID AND OIL — Motor oil • Transmission oil • Brake fluid • Antifreeze • Technical lubricant



In store "130" you can find and buy almost all necessary goods for your auto in Kyiv and other cities, delivery by ground and postal services. Our experienced consultants will provide you with exhaustive information and help you to chose the very particular thing. We are waiting for you at the address

<https://130.com.ua>

polk®

# REACT SOUND BAR

---

Owner's Manual

What you can do with this unit .....	4	Playback .....	22
Accessories .....	6	Enjoying TV, movies and music .....	22
Inserting the batteries .....	7	Listening to music on a Bluetooth device .....	23
Operating range of the remote control unit .....	7	Pairing a Bluetooth device for the first time .....	23
Part names and functions .....	8	Pairing with other Bluetooth devices .....	24
Sound bar .....	8	Listening to music with a paired Bluetooth device ...	24
Remote control unit .....	12	Spotify Connect function .....	25
Connections .....	14	Settings .....	26
Positioning .....	14	Settings .....	26
Positioning the sound bar .....	14	Adjusting the volume .....	26
Connecting a TV .....	17	Adjusting the subwoofer volume .....	26
Connection 1: TV equipped with an HDMI connector and compatible with the ARC (Audio Return Channel) .....	18	Adjusting the dialogue sound .....	26
Connection 2: TV equipped with an optical digital connector .....	19	Selecting a listening mode .....	27
Connecting the power cords .....	20	Turning off the sound temporarily .....	27
Getting the Alexa App .....	21	Operating this unit using the remote control of a TV .....	28

Tips .....	30
Troubleshooting .....	30
Power does not turn on / Power is turned off .....	31
Operations cannot be performed through the remote control unit .....	31
No sound comes out .....	32
Bluetooth playback does not work .....	33
The HDMI Control function does not work .....	34
Alexa does not respond even if called .....	34
LED is dark .....	34
Resetting factory settings .....	35
Appendix .....	36
About HDMI .....	36
Power management .....	37
Power modes .....	37
Trademark information .....	39
Specifications .....	40
Sound bar .....	40

Thank you for purchasing this Polk product.  
To ensure proper operation, please read this owner's manual carefully before using the product.  
After reading this manual, be sure to keep it for future reference.

## What you can do with this unit

This sound bar enables you to connect this unit to your TV to enjoy high-quality sound.

### ■ Playing TV audio

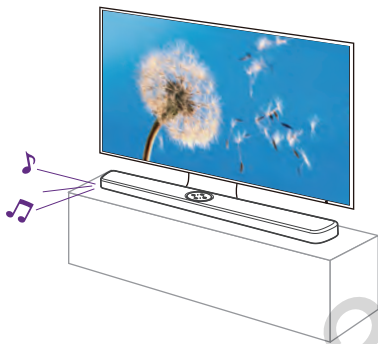

[Related information]

- "Enjoying TV, movies and music" (👉 p. 22)

### ■ Using the app for smartphones/tablets (Alexa App) for easy operation

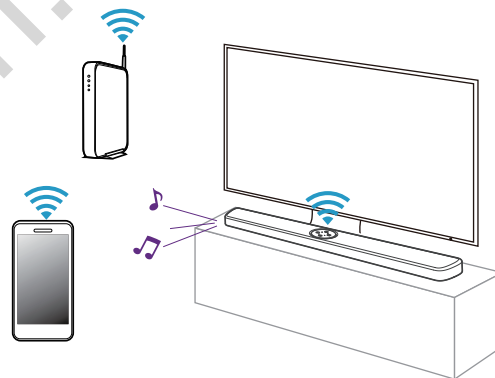

[Related information]

- "Getting the Alexa App" (👉 p. 21)

## ■ Operating by talking to Alexa

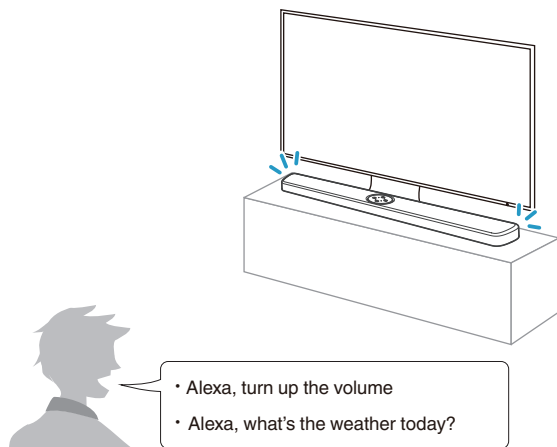

- Alexa isn't available in certain languages and countries.

[Related information]

- "Getting the Alexa App" (👉 p. 21)

## ■ Playing a Bluetooth device

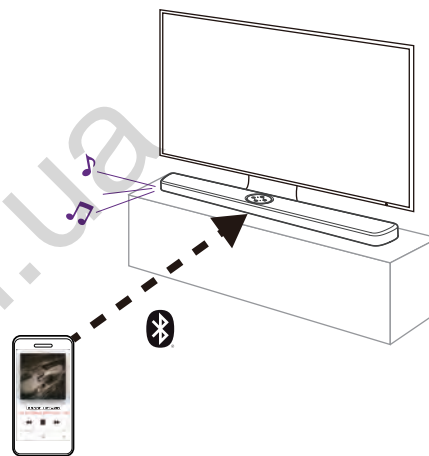







[Related information]

- "Listening to music on a Bluetooth device" (👉 p. 23)

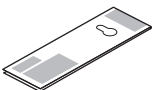
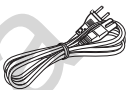
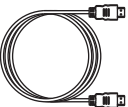
## Accessories

Check that the following parts are supplied with the product.

 <p>Quick Start Guide</p>	 <p>Safety Instructions</p>	 <p>Wall mount template</p>	 <p>Power cord</p>	 <p>HDMI cable</p>
 <p>Optical digital cable</p>	 <p>Wall mount spacers</p>	 <p>Remote control unit</p>	 <p>R03/AAA batteries</p>	

## Inserting the batteries

- 1 Slide the rear cover off the remote control unit in the arrow direction.

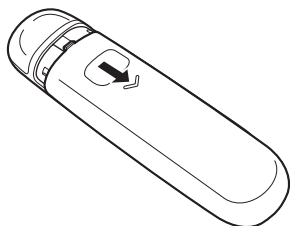

- 2 Insert two batteries correctly into the battery compartment as indicated.

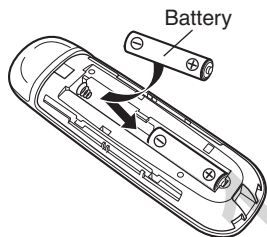

- 3 Put the rear cover back on.

### NOTE

- Remove the batteries from the remote control unit if it will not be in use for long periods.
- If the battery fluid should leak, carefully wipe the fluid off the inside of the battery compartment and insert new batteries.

## Operating range of the remote control unit

Point the remote control unit at the remote sensor when operating it.

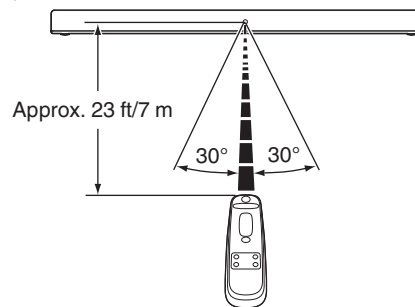



## Part names and functions

### Sound bar

#### ■ Top panel

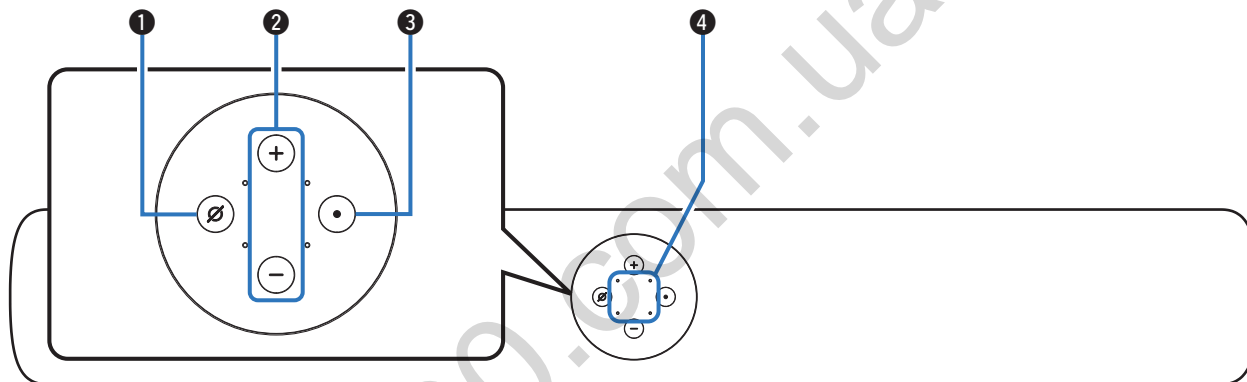

For details, see the next page.

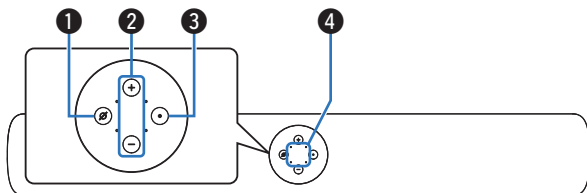

### 1 Microphone mute button (Ø)

This disables the microphone. While the microphone is disabled, the button lights up in red. Pressing the button again enables the microphone.

### 2 Volume buttons (+, -)

These adjust the volume level. (👉 p. 26)

### 3 Action button (●)

This invokes Alexa.

You cannot operate the button while the microphone is muted.

### Ambient light sensor

This detects the ambient brightness and automatically adjusts the brightness of the status LED, the light bar, and the microphone mute button to correspond with the ambient brightness.

### 4 Microphone

This is the microphone to talk to Alexa.



- Do not put anything on top of the sound bar. Doing so may lead to accidental operations.
- This microphone cannot be used for calls.

## ■ Front panel

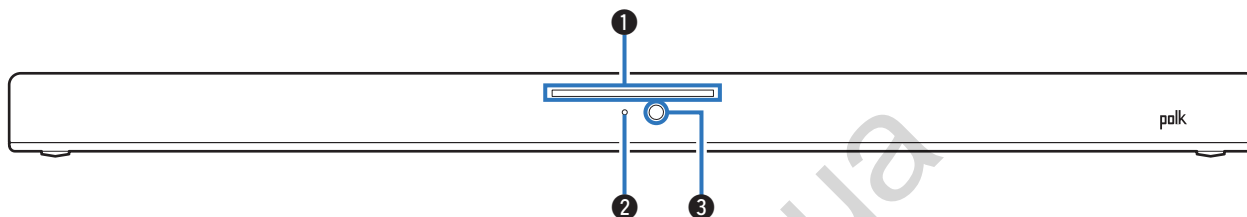

### ① Light bar

While Alexa responds, the LED lights up.

When the volume button is pressed, the LED displays the volume level.

### ② Status LED

Displays the status of input source / audio decoding / sound mode, etc.

Input source	TV(HDMI ARC)	○ (White)
	TV(Optical)	○ (White)
	Bluetooth	● (Blue)
Audio decoding	(PCM)	● (Orange)
	(DTS)	● (Yellow)
	(Dolby)	● (Green)
Sound mode	Night mode	● (Purple)

### ③ Remote control sensor

This receives signals from the remote control unit. (🔗 p. 7)

## ■ Rear panel

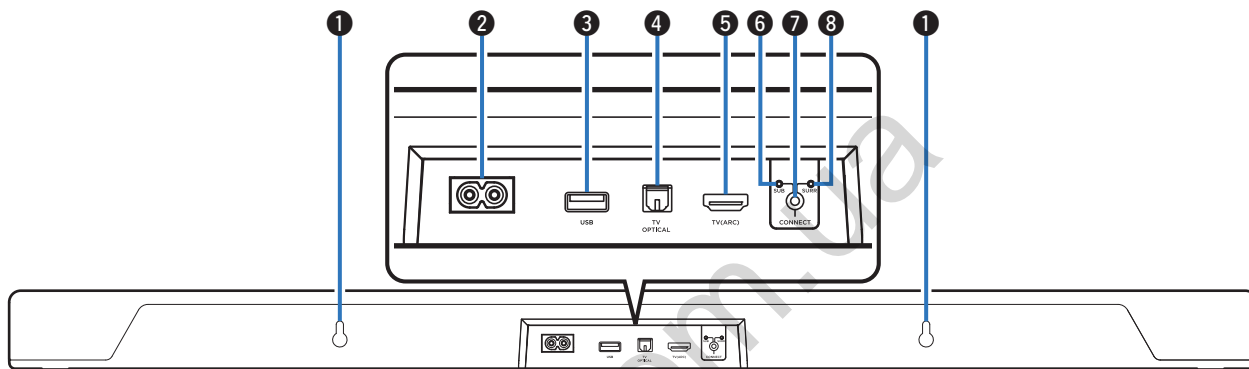

### ❶ Wall hook hole

Used to mount the sound bar on a wall. (👉 p. 15)

### ❷ AC inlet

Used to connect the power cord. (👉 p. 20)

### ❸ USB port

USB playback is available.

### ❹ Optical digital input connector (TV OPTICAL)

Use the included optical digital cable to connect a TV with an optical digital terminal. (👉 p. 19)

### ❺ HDMI connector (TV (ARC))

Use the included HDMI cable to connect an ARC function-compatible TV. (👉 p. 18)

### ❻ SUB LED

This LED lights up in green when the sound bar is paired with the optional subwoofer.

### ❼ CONNECT button

Used to pair the optional subwoofer and surround speakers with the sound bar.

### ❽ SURR LED

This LED lights up in green when the sound bar is paired with the optional surround speakers.

## Remote control unit

This section mainly explains remote control operations.

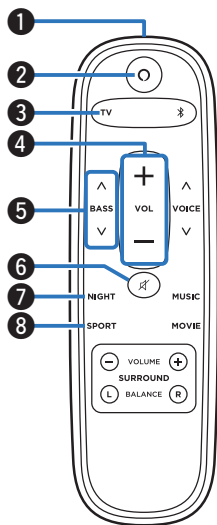

### 1 Remote control signal transmitter

This transmits signals from the remote control unit. (👉 p. 7)

### 2 Action button (○)

This invokes Alexa.

### 3 Input source button (TV)

This switches the input source to TV. (👉 p. 22)

### 4 Volume buttons (VOL +, -)

These adjust the volume level. (👉 p. 26)

### 5 Bass volume control buttons (BASS +, -)

This setting adjusts the volume level for the bass. (👉 p. 26)

### 6 Mute button (🔇)

This mutes the output audio. Press again to unmute. (👉 p. 27)

### 7 Night mode button (NIGHT)

Compresses the dynamic range (difference between loud and soft sounds) to make audio easier to hear at low volumes. (👉 p. 27)

### 8 Sport mode button (SPORT)

Enhances dialogue-rich content, like sporting events, news casts and talk shows. (👉 p. 27)

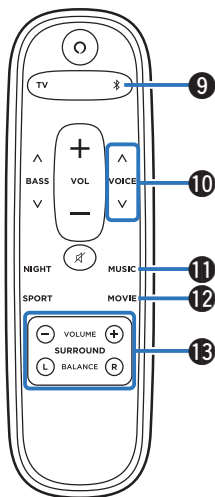

### 9 Input source button (TV)

This switches the input source to TV. (👉 p. 22)

### 10 Voice adjust buttons (VOICE +, -)

Adjust the volume of dialog in movies, vocals in music, etc. so these can be heard more easily. (👉 p. 26)

### 11 Music mode button (MUSIC)

Switches to the sound mode suitable for enjoying music. (👉 p. 27)

### 12 Movie mode button (MOVIE)

Enjoy movie theater-like surround sound. (👉 p. 27)

### 13 Surround buttons (SURROUND)

Used to adjust the surround sound channel volume and balance when optional surround speakers are connected.

## Positioning

### Positioning the sound bar

Position the sound bar in front of your TV, etc., on a flat surface.

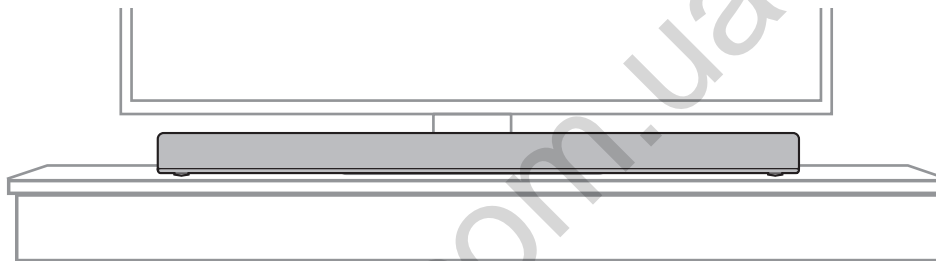

#### NOTE

- When positioning the sound bar in front of your TV, make sure the sound bar does not obstruct the TV's remote control light sensor, etc.

## ■ When hanging the sound bar on a wall

The sound bar has a wall hook hole to hang it on a wall. When hanging it on a wall, position it in a flat, vertical position.

To ensure safety, request a contractor perform the mounting work when mounting onto a wall.

### NOTE

- In order to use the unit safely, do not place items on or hang items from the unit.
- Be sure to fix connection cables to the wall to ensure that cannot be pulled or tripped over causing this unit to fall. Check that the unit is mounted safely after the mounting work is complete.
- Also, periodically check the safety of this unit and whether there is a possibility that the unit may fall.
- When hanging it on a wall, position it so as to show the microphone hole on the top panel of the sound bar. If you position it so as not to show the microphone hole, the microphone may not pick up your voices talking to Alexa. Be careful of the positioning because the TV on the wall may hide the microphone hole.
- Polk cannot accept any responsibility for damage, injury or accidents caused by problems with the mounting location or mounting method.

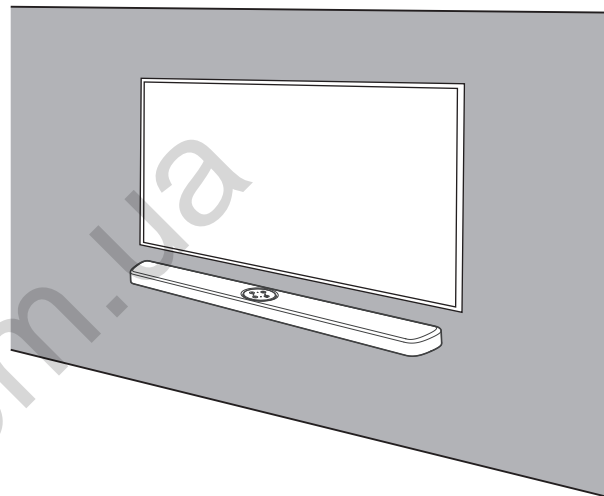





- When hanging it on a wall, use the included wall mount template.

[How to use the wall mount template]

- ① Affix the template to the location you would like to mount the sound bar.
- ② Screw in the wall mount screws by following the template.  
Consult a construction professional about the proper wall mount screws for the material and strength of your wall.
- ③ Remove the template from the wall.
- ④ Mount the included wall mount spacer on the spine of the sound bar.  
Mounting the wall mount spacer creates a space for cords to pass through between the sound bar and the wall.
- ⑤ Mount the sound bar on the wall.

130.com.ua

## Connecting a TV

How to connect a TV depends on the connectors and functions equipped on the TV.



- Enable the TV's HDMI control function when using an HDMI cable to connect this device to your TV. (See the TV owner's manual for details.)
- Turn off the TV's speaker or minimize the volume when using this device.
- HDMI cable connection is recommended, but connection can be performed without an HDMI cable.

### NOTE

- Make sure all devices are off when connecting.
- Do not plug device power cords into an outlet until all devices have been connected.

## Connection 1: TV equipped with an HDMI connector and compatible with the ARC (Audio Return Channel)

Use the included HDMI cable to connect this device to an ARC function-compatible TV.

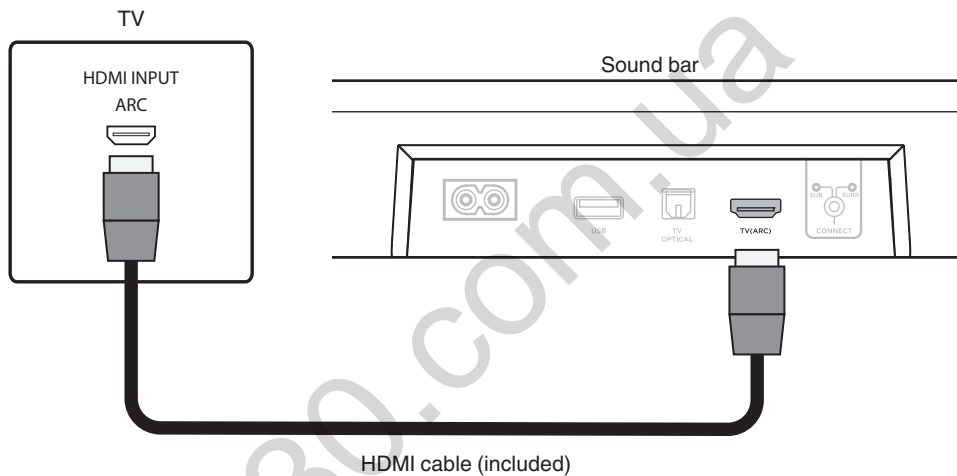

- The TV also needs to be compatible with the ARC function.

## Connection 2: TV equipped with an optical digital connector

Use the included optical digital cables to connect this device to your TV.

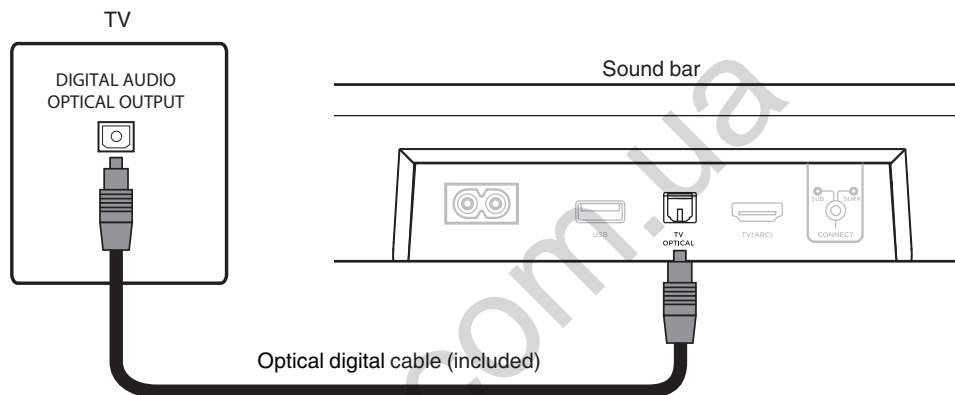

- Line up the optical digital cable with the shape of the terminal to insert.

## Connecting the power cords

After completing all the connections, insert the power plug into the power outlet.

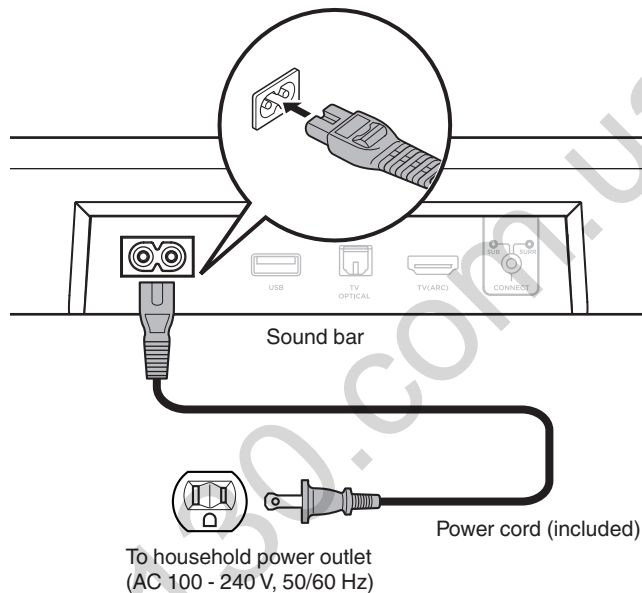

## Getting the Alexa App

Install the Alexa App on your mobile device and connect this unit to the network.



- If you are already using a product with Alexa built-in, it is automatically connected to this unit.
- Check whether your mobile device is connected to your home router before you operate it.
- Enable Bluetooth on your mobile device.

### 1 Install the (free) Alexa App on your mobile device.

Download "Alexa App" from the App Store or the Google Play store.

### 2 Configure the settings according to the instructions on the App screen.

## Enjoying TV, movies and music

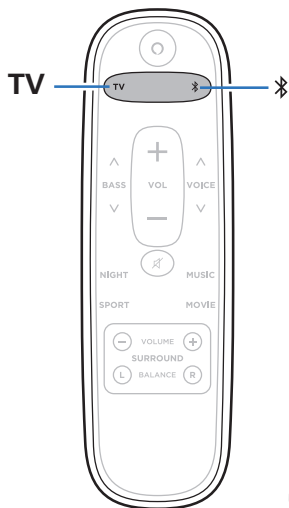

### 1 Press the input source button.

TV:	Device connected to the TV (HDMI ARC/ OPTICAL)
 :	Bluetooth device

### 2 Play the device connected to this unit.

For details, see the relevant device manual.



- Connect an HDMI control-compatible TV and this device via HDMI and enable the HDMI control to enable linked control from either device. (p. 36)

## Listening to music on a Bluetooth device

Music files stored on Bluetooth devices such as smartphones, digital music players, etc. can be enjoyed on this unit by pairing and connecting this unit with the Bluetooth device.

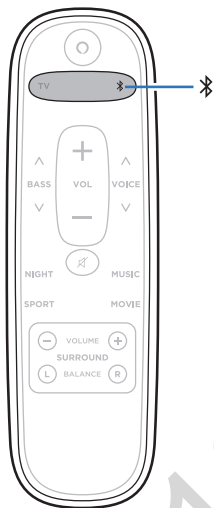

### Pairing a Bluetooth device for the first time

Pair a Bluetooth device with this unit.

Once the Bluetooth device has been paired, it does not need to be paired again.

- 1 Press  to switch the input source to "Bluetooth".**  
Automatically switches to pairing mode the first time it is used.  
The status display LED blinks in blue when this unit is in pairing mode.
- 2 Activate the Bluetooth settings on your Bluetooth device.**
- 3 Select "Polk React Sound Bar" (Default) from the list of devices displayed on the screen of the Bluetooth device.**  
The status display LED lights up in blue and this device and the Bluetooth device are paired.



## Pairing with other Bluetooth devices

- 1 Press **⌘** to switch the input source to "Bluetooth".
- 2 Activate the Bluetooth settings on your Bluetooth device.
- 3 Push **⌘** on this device until the status display LED blinks in blue.
- 4 Select "Polk React Sound Bar" (Default) from the list of devices displayed on the screen of the Bluetooth device.

The status display LED lights up in blue and this device and the Bluetooth device are paired.



- This unit can be paired with a maximum of 8 Bluetooth devices. When a 9th Bluetooth device is paired, it will be registered in place of the oldest registered device.

## Listening to music with a paired Bluetooth device

- 1 Press **⌘** to switch the input source to "Bluetooth".
- 2 Activate the Bluetooth settings on your Bluetooth device.  
The status display LED lights up in blue and connects to the last Bluetooth device connected. If the connection is cut, perform connection again.
- 3 Play music using any app on your Bluetooth device.

## Spotify Connect function

Spotify is all the music you'll ever need. Millions of songs available instantly. Just search for the music you love, or let Spotify play you something great. Spotify works on your phone, tablet, computer and home speakers. So you'll always have the perfect soundtrack for whatever you're doing. Now you can enjoy Spotify with your free account as well as Premium account. Use your phone, tablet or computer as a remote control for Spotify.

Go to [www.spotify.com/connect](http://www.spotify.com/connect) to learn how.

The Spotify software is subject to third party licenses found here:

[www.spotify.com/connect/third-party-licenses](http://www.spotify.com/connect/third-party-licenses)

130.com.ua

## Settings

Perform the below operations and settings as needed.

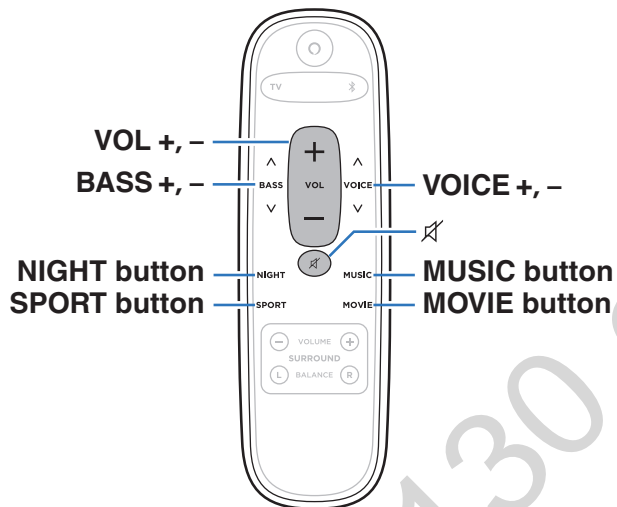

### Adjusting the volume

#### 1 Use VOL + or VOL – to adjust the volume.

The light bar changes to the volume display when these buttons are pressed.

### Adjusting the subwoofer volume

#### 1 Use BASS + or BASS – to adjust the bass volume.

The light bar changes to the volume display when these buttons are pressed.

### Adjusting the dialogue sound

Adjust the volume of dialog in movies, vocals in music, etc. so these can be heard more easily.

#### 1 Use VOICE + or VOICE – to adjust the voice volume.

The light bar changes to the volume display when these buttons are pressed.

## Selecting a listening mode

### 1 Press the listening mode button to select a listening mode.

When the button is pressed, the rightmost status display LED flashes and the listening mode changes.

<b>MOVIE:</b>	Enjoy movie theater-like surround sound.
<b>NIGHT:</b>	Compresses the dynamic range (difference between loud and soft sounds) to make audio easier to hear at low volumes.
<b>MUSIC:</b>	Enjoy the full presence of a wide, encompassing acoustic field.
<b>SPORT:</b>	Enhances dialogue-rich content, like sporting events, news casts and talk shows.

## Turning off the sound temporarily

### 1 Press .

The status LED blinks in white.



- To cancel, press  again.

## Operating this unit using the remote control of a TV

There are three ways to operate this unit using the remote control of a TV.

### • HDMI control function

Connect this unit to a TV that supports the HDMI control function with an HDMI cable and enable the HDMI control setting on the TV to perform basic operations on this unit (changing the input source, turning the power on and off, adjusting the volume) with the remote control of the TV.

Refer to "HDMI control function" for more information about the HDMI control function. (📖 p. 36)

### • Remote control preset function

If your TV is connected via optical, you may be able control the volume and mute functions on this unit from your TV without any further setup if your TV is one of supported brands.

### • Remote control learning function

If your TV does not support the HDMI control function, use this unit's remote control learning function. This enables you to operate this unit with the remote control of a TV. ("Using the remote control learning function" (📖 p. 28))

## ■ Using the remote control learning function

**1** Press and hold the  $\emptyset$  for 3 seconds or more until the voice guidance responds.

**2** Point the remote control of this unit at the remote sensor of this unit and press the remote control button to be learned (e.g. VOL +) once.

The voice guidance responds.

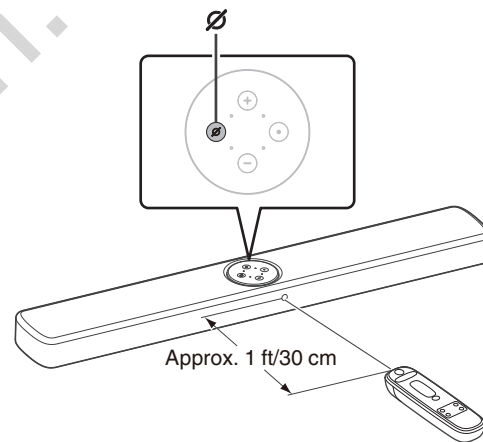

### 3 Point the remote control of the TV at the remote control sensor of this unit and press the remote control button to be learned (e.g. the button to increase the volume) 3 times.

If learning is successful, the status LED blinks in green once, and the voice guidance responds.

If learning is unsuccessful, the status LED blinks in red once. Repeat steps 2 and 3 if this happens.



- When the status LEDs blink in white again, press the TV remote control button (e.g. the button to increase the volume) once more.

### 4 To learn a new function, repeat steps 2 and 3 with the next function.

### 5 Press and hold the main unit's $\emptyset$ for 3 seconds.

The unit exits remote control learning mode.

### 6 Confirm that the operation (e.g. increasing the volume) can be performed on this unit with the TV remote control.



- To delete all learned data, press and hold  $\emptyset$  on the sound bar for 10 seconds.
- Operations cannot be performed with the remote control learning function during the low energy mode.
- Other operations cannot be performed when in remote control learning mode.
- Remote control learning may not be possible depending on the type of TV remote control.

## Troubleshooting

---

If a problem should arise, first check the following:

1. **Are the connections correct?**
2. **Is the set being operated as described in the owner's manual?**
3. **Are the other devices operating properly?**

If this unit does not operate properly, check the corresponding symptoms in this section.

If the symptoms do not match any of those described here, consult your dealer as it could be due to a fault in this unit. In this case, disconnect the power immediately and contact the store where you purchased this unit.

## Power does not turn on / Power is turned off

### Power does not turn on.

- Check whether the power plug is correctly inserted into the power outlet. (👉 p. 20)

### Power automatically turns off.

- If no operations have been performed for 20 minutes or more and audio is not being input, this device automatically switches to voice initiated mode.  
Turn this device's power on again. (👉 p. 37)

## Operations cannot be performed through the remote control unit

### Operations cannot be performed through the remote control unit.

- Battery is worn out. Replace with new battery. (👉 p. 7)
- Operate the remote control unit within a distance of about 23 ft/7 m from this unit and at an angle of within 30°. (👉 p. 7)
- Remove any obstacle between this unit and the remote control unit.
- Insert the battery in the proper direction, checking the ⊕ and ⊖ marks. (👉 p. 7)
- The set's remote control sensor is exposed to strong light (direct sunlight, inverter type fluorescent bulb light, etc.). Move the set to a place in which the remote control sensor will not be exposed to strong light.



## No sound comes out

### No sound comes out.

- Check the connections for all devices. (👉 p. 14)
- Insert connection cables all the way in.
- Check that input connectors and output connectors are not reversely connected.
- Check cables for damage.
- Check that a proper input source is selected. (👉 p. 22)
- Adjust the volume. (👉 p. 26)
- Make sure volume is not muted. (👉 p. 27)

130.com.ua

## Bluetooth playback does not work

### Cannot pair with a Bluetooth device.

- It may be that Bluetooth is not enabled on the Bluetooth device. See the owner's manual of the Bluetooth device to enable the Bluetooth function.
- This device may be paired with another Bluetooth device. Select this unit from the list of devices displayed on the screen of the Bluetooth device.
- Bring the Bluetooth device near to this unit.
- Turn the power of the Bluetooth device off and on again, and then try again.
- Only 1 Bluetooth device can be connected at a time.

### The sound is cut off.

- Bring the Bluetooth device near to this unit.
- Remove obstructions between the Bluetooth device and this unit.
- To prevent electromagnetic interference, locate this unit away from microwave ovens, wireless LAN devices and other Bluetooth devices.
- Pair with the Bluetooth device again. (👉 p. 23)

## The HDMI Control function does not work

### The HDMI Control function does not work.

- You cannot operate devices that are not compatible with the HDMI Control function. In addition, depending on the connected device or the settings, the HDMI Control function may not work. In this case, operate the external device directly.
- Check that the HDMI Control function setting is enabled on all devices connected to this unit.

## Alexa does not respond even if called

### The microphone is disabled.

- Press the  button to enable the microphone.

## LED is dark

### LED is dark.

- This unit has a built-in illuminance sensor in one of the buttons on the top panel. Make sure the button is not in shadow and is clean.  
( p. 9)

## Resetting factory settings

Perform this procedure if the display is abnormal or if operations cannot be performed.

Various settings are reset to the factory default values. Make settings again.

### 1 Press and hold the Action button until the light bar turns orange (about 25 seconds).

- The light bar turns blue indicating the reset sequence has started.
- This unit automatically restarts in a factory default values.

130.com.ua

## About HDMI

This unit supports the following HDMI functions.

- **ARC (Audio Return Channel) function**

Enjoy movies, music, etc., on your TV simply by connecting an ARC function-compatible TV to this device via HDMI.

- **HDMI control function**

Connect an HDMI control-compatible TV and this device via HDMI and enable the HDMI control to enable linked control from either device.

- **Input source switching**

If the TV is turned on, this device automatically powers on and switches the input source.

- **Power off link**

The TV power off operation is linked so this device also turns off.

- **Volume adjustment**

The volume of this unit can be adjusted using the TV remote control.

- **Audio output destination switching**

If this unit is turned on, TV audio is output from this unit. If this device is turned off, TV audio is output from the speakers of the TV.

### NOTE

- Some functions may not operate depending on the connected TV.

# Power management

## Power modes

### ■ Voice initiated mode

This unit has prepared a voice initiated mode in active mode. It is a voice initiated mode that reduces the power consumption as low as possible by reducing the operation of other peripheral circuits including the digital signal processor while operating the main feature voice control.

#### ❑ Wi-Fi

After around 20 minutes of no operation and no network access after playing music via Wi-Fi. This unit enters the voice initiated mode.

#### ❑ Bluetooth

After the Bluetooth connection is disconnected and there is around 20 minutes of no operation and no network access after playing music via Bluetooth. This unit enters the voice initiated mode.

#### ❑ Optical input

After around 20 minutes of no operation after optical device is put into voice initiated mode.

#### ❑ HDMI output (ARC)

Connect this unit and the ARC compatible TV with HDMI cable and play TV. Around 20 minutes after TV is put into voice initiated mode.

## ■ Standby mode

This unit can be placed into standby mode, in which its standby power consumption is lower than in voice initiated mode.

- Press the mic mute button twice while holding down the action button.

The voice guidance responds, and light on the light bar spins.



- You also press the action button, the device enters the voice initiated mode.

## ■ Off

To completely turn off the power to the device you must remove the mains plug from the power outlet.

## Trademark information



The Bluetooth® word mark and logos are registered trademarks owned by the Bluetooth SIG, Inc. and any use of such marks by Polk Audio is under license. Other trademarks and trade names are those of their respective owners.



Manufactured under license from Dolby Laboratories. Dolby, Dolby Audio, Pro Logic, and the double-D symbol are trademarks of Dolby Laboratories Licensing Corporation.



For DTS patents, see <http://patents.dts.com>. Manufactured under license from DTS, Inc. DTS, Digital Surround, and the DTS logo are registered trademarks or trademarks of DTS, Inc. in the United States and other countries. © 2020 DTS, Inc. ALL RIGHTS RESERVED.



The terms HDMI, HDMI High-Definition Multimedia Interface, and the HDMI Logo are trademarks or registered trademarks of HDMI Licensing Administrator, Inc.



# Specifications

## Sound bar

### ■ General

Operating temperature:	5 °C - 35 °C
Power supply:	AC 100 - 240 V, 50/60 Hz
Power consumption:	30 W
Power consumption in voice initiated mode:	3.9 W (Wi-Fi) 3.8 W (Bluetooth) 3.8 W (HDMI,ARC) 3.9 W (Optical)
Power consumption in standby mode:	0.4 W
Sampling frequency:	32 kHz, 44.1 kHz, 48 kHz
Supported audio formats:	Linear PCM, Dolby Digital, DTS Digital Surround

## ■ Wireless LAN section

<b>Network type (wireless LAN standard):</b>	Conforming to IEEE 802.11a/b/g/n/ac
<b>Used frequency range:</b>	2.4 GHz, 5 GHz

## ■ Bluetooth section

<b>Communications system:</b>	Bluetooth Version 4.2
<b>Transmission power:</b>	Power Class 2
<b>Maximum communication range:</b>	Approx. 32.8 ft/10 m in line of sight*
<b>Used frequency range:</b>	2.4 GHz band
<b>Modulation scheme:</b>	FHSS (Frequency-Hopping Spread Spectrum)
<b>Supported profiles:</b>	A2DP (Advanced Audio Distribution Profile) 1.3 AVRCP (Audio Video Remote Control Profile) 1.6
<b>Corresponding codec:</b>	SBC, AAC
<b>Transmission range (A2DP):</b>	20 Hz – 20,000 Hz

\*The actual communication range varies depending on the influence of such factors as obstructions between devices, electromagnetic waves from microwave ovens, static electricity, cordless phones, reception sensitivity, antenna performance, operating system, application software etc.

## ■ Dimensions (Unit : in. (mm))

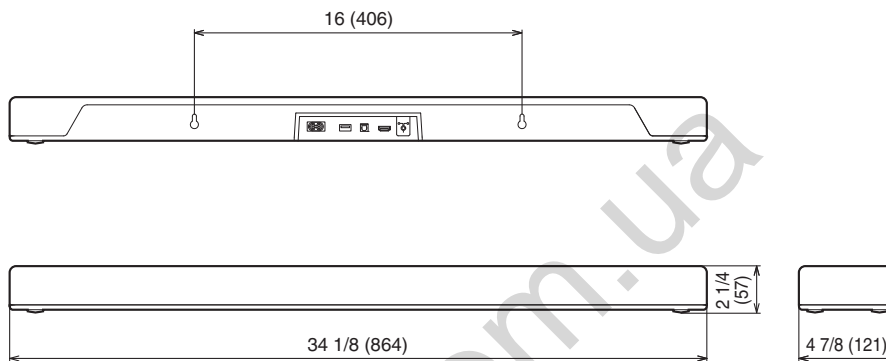

## ■ Weight : 6 lbs 6 oz (2.9 kg)

130.com.ua

**polk**<sup>®</sup>

3520 10804 00AK  
©2020 Sound United. All Rights Reserved.

Autogoods "130"