



PHONES

0 (800) 800 130
(050) 462 0 130
(063) 462 0 130
(067) 462 0 130

130
COM.UA

Internet store of
autogoods



SKYPE

km-130

CAR RECEIVERS — Receivers • Media receivers and stations • Native receivers • CD/DVD changers • FM-modulators/USB adapters • Flash memory • Facia plates and adapters • Antennas • Accessories |
 CAR AUDIO — Car audio speakers • Amplifiers • Subwoofers • Processors • Crossovers • Headphones • Accessories | TRIP COMPUTERS — Universal computers • Model computers • Accessories |
 GPS NAVIGATORS — Portable GPS • Built-in GPS • GPS modules • GPS trackers • Antennas for GPS navigators • Accessories | VIDEO — DVR • TV sets and monitors • Car TV tuners • Cameras • Videomodules
 • Transcoders • Car TV antennas • Accessories | SECURITY SYSTEMS — Car alarms • Bike alarms • Mechanical blockers • Immobilizers • Sensors • Accessories | OPTIC AND LIGHT — Xenon • Bixenon • Lamps
 • LED • Stroboscopes • Optic and Headlights • Washers • Light, rain sensors • Accessories | PARKTRONICS AND MIRRORS — Rear parktronic • Front parktronic • Combined parktronic • Rear-view mirrors
 • Accessories | HEATING AND COOLING — Seat heaters • Mirrors heaters • Screen-wipers heaters • Engine heaters • Auto-refrigerators • Air conditioning units • Accessories | TUNING — Vibro-isolation
 • Noise-isolation • Tint films • Accessories | ACCESSORIES — Radar-detectors • Handsfree, Bluetooth • Windowlifters • Compressors • Beeps, loudspeakers • Measuring instruments • Cleaners • Car seats
 • Miscellaneous | MOUNTING — Installation kits • Upholstery • Grilles • Tubes • Cable and wire • Tools • Miscellaneous | POWER — Batteries • Converters • Start-charging equipment • Capacitors
 • Accessories | MARINE AUDIO AND ELECTRONICS — Marine receivers • Marine audio speakers • Marine subwoofers • Marine amplifiers • Accessories | CAR CARE PRODUCTS — Additives • Washer fluid •
 Care accessories • Car polish • Flavors • Adhesives and sealants | LIQUID AND OIL — Motor oil • Transmission oil • Brake fluid • Antifreeze • Technical lubricant



In store "130" you can find and buy almost all necessary goods for your auto in Kyiv and other cities, delivery by ground and postal services. Our experienced consultants will provide you with exhaustive information and help you to choose the very particular thing. We are waiting for you at the address

<https://130.com.ua>

Station. Using this product in this condition may result in permanent damage to the system.

- Do not disassemble or modify this product, as there are high-voltage components inside which may cause an electric shock. Be sure to consult your dealer or the nearest authorized Pioneer Service Station for internal inspection, adjustments or repairs.

Before using this product, be sure to read and fully understand the following safety information:

- Do not operate this product if doing so will divert your attention in any way from the safe operation of your vehicle. Always observe safe driving rules and follow all existing traffic regulations. If you experience difficulty in operating this product or reading the display, park your vehicle in a safe location and apply the parking brake before making the necessary adjustments.
- Never set the volume of this product so high that you cannot hear outside traffic and emergency vehicles.
- Keep this manual handy as a reference for operating procedures and safety information.
- Certain functions (such as viewing of screen and certain button operations) offered by this product could be dangerous (possibly resulting in serious injury or death) and/or unlawful if used while driving. Screen display and button operation are disabled for this product while the vehicle is moving.

To ensure safe driving

▲ WARNING

- In some countries the viewing of video image on a display inside a vehicle even by persons other than the driver may be illegal. Where such regulations apply, they must be obeyed.

Precautions before connecting the system

▲ CAUTION

- Firmly install this product so it does not fall off the window. If this product is not firmly installed, it may fall off the window while driving and cause an accident. Periodically inspect this product.
- Secure all wiring with cable clamps or electrical tape. Do not allow any bare wiring to remain exposed.
- It is extremely dangerous to allow cables to become wound around the steering column or gearstick. Be sure to install this product, its cables, and wiring away in such so that they will not obstruct or hinder driving.
- Make sure that the cables and wires will not interfere with or become caught in any of the vehicle's moving parts, especially the steering wheel, gearstick, handbrake, sliding seat tracks, doors, or any of the vehicle's controls.
- Do not route wires where they will be exposed to high temperatures. If the insulation heats up, wires may become damaged, resulting in a short circuit or malfunction and permanent damage to the product.
- Do not shorten any cables. If you do, the protection circuit (fuse holder, fuse resistor or filter, etc.) may fail to work properly.
- Never feed power to other electronic products by cutting the insulation of the power supply cable of this product and tapping into the cable. The current capacity of the cable will be exceeded, causing overheating.

To prevent damage

▲ WARNING

- When replacing the fuse, be sure to only use a fuse of the rating prescribed on this product.

Precautions before installation

▲ CAUTION

- Never install this product in places where, or in a manner that:
 - Could injure the driver or passengers if the vehicle stops suddenly.
 - May interfere with the driver's operation of the vehicle, such as on the floor in front of the driver's seat, or close to the steering wheel or gearstick.
 - To ensure proper installation, be sure to use the supplied parts in the manner specified. If any parts are not supplied with this product, use compatible parts in the manner specified after you have the parts' compatibility checked by your dealer. If parts other than supplied or compatible ones are used, they may damage internal parts of this product or they may work loose and the product may become detached.
- Do not install this product where it may
 - (i) obstruct the driver's vision,
 - (ii) impair the performance of any of the vehicle's operating systems or safety features, including airbags, hazard lamp buttons or
 - (iii) impair the driver's ability to safely operate the vehicle.
- Never install this product in front of or next to the place in the dashboard, door, or pillar from which one of your vehicle's airbags would deploy. Please refer to your vehicle's owner's manual for reference to the deployment area of the frontal airbags.
- Consult with your nearest dealer if installation requires drilling holes or other modifications of the vehicle.
- Before making a final installation of this product, temporarily connect the wiring to confirm that the connections are correct and the system works properly.
- Do not install this product in places subject to high temperatures or humidity, such as:
 - Places close to a heater, vent or air conditioner.
 - Places that may be exposed to rain, such as close to the door or on the vehicle's floor.

Precautions for cigarette lighter plug

▲ WARNING

- When using a power supply in the vehicle, use the dedicated cigarette lighter plug. Using a plug other than the specified plug may result in fire, electric shock, or product failure.
- Unplug the cigarette plug after using the product and when the product will not be used for a long period of time. Depending on the vehicle, the cigarette socket may not be turned off even when the engine is turned off.
- Fully insert the cigarette lighter plug. Poor contact may occur due to vibrations while driving, resulting in an extremely dangerous situation where the unit overheats.
- Regularly inspect and clean the cigarette lighter socket. Foreign material inside the cigarette lighter socket, such as ashes, may cause heat generation due to poor contact, resulting in fire or electric shock.

Disclaimer

- Given the large number of variables and conditions that can be involved in an accident, Pioneer cannot guarantee that every accident or occurrence will trigger the recording feature in this device.
- This product features may not operate properly due to the effects of settings, how this product is installed, the condition of the microSD card, and driving conditions (including the road conditions).
- If brightly colored objects are placed on the dashboard, they may be reflected in the front windshield and the camera image. Do not place brightly colored objects on the dashboard.
- This product is not guaranteed to be effective as evidence in an accident.
- This product is not guaranteed to save video in all situations.
- You may not be able to recognize the conditions in the front of the vehicle in recorded video, depending on the ambient conditions, such as the weather and time.

- LED traffic signals may appear as flashing or flickering when recorded with this product. The color may also not be correctly identifiable. Pioneer Corporation accepts no responsibility whatsoever for these phenomena.
- This product saves video before and after an accident occurs by detecting the impact (acceleration) with the G-sensor (accelerometer). However, this product is not guaranteed to save video in all situations.
- Pioneer Corporation accepts no responsibility whatsoever for product failures or damage that occur due to the microSD card wearing out.
- Pioneer Corporation does not make any assurances that microSD card problems will be repaired by formatting the card. Pioneer Corporation bears no responsibility for files that are erased from the microSD card or damage that occurs from formatting the card. Format the microSD card according to your own judgment and at your own responsibility.

How to read this Manual

Notation	Meaning
	These symbols are used to draw your attention to items you should be aware of when using this product and items you should be aware of to maintain its performance.
Note /Notes	Notes provide useful tips and extra information about product features.
[○○]	Square brackets are used to indicate selectable items displayed on the screen.
→ “○○○○”	Quotation marks are used to indicate references and settings.

- The illustrations and example screens used in this manual may differ from the actual product.
- The actual screens of the product may be changed without prior notification for the purpose of improvements to product performance and features.

- In this manual, the microSDHC memory card is referred to as "the microSD card" for convenience.

Usage Precautions

▲ Precautions When Handling this product

- The driver may manually set the device to save video to assist in the monitoring of driver performance.
- There are limits to the scope of video that can be recorded with this product (→ *Specifications*). First check the video that will be recorded before using this product.
- Be careful not to infringe on the privacy of any subject in video recorded with this product when using said video. You are fully responsible for the use of said video. Video recorded with this product may include personal information, such as license plate numbers.
- When this product is not fully charged immediately after purchase and the power to this product is

stopped (the engine is turned off and the Cigarette Lighter Power Cable is unplugged), the recording time may be shorter or this product may not be able to record video.

- The internal battery is a consumable part. The operating time will slowly decrease as the battery is repeatedly charged. Contact Pioneer support if you feel that the operating time has become too short.
- If this product is used near another device that uses GPS, such as a car navigation system, that device may temporarily be unable to receive radio waves from GPS satellites due to radio interference. There may also be a negative impact on the functions of surrounding devices.
- Pioneer does not offer a data recovery service for corrupted or deleted files.

- The storage areas on the microSD card are split into the four areas shown in the following diagram according to the type of recording.

	Continuous video file storage area
	Event video file storage area
	Parking mode video file storage area
	Photo file storage area

You can change the percentage of space used by these storage areas.

→ *“System” - “SD card partition”*

- Note that files be overwritten when there is insufficient free space in the file storage areas. We recommend that you back up any important files you want to keep.
- *“Using this product” - “Backing Up Recorded Files”*
- You can view video files on your PC. However, the video may stutter or stop depending on the performance of the PC.
- The power terminal will be extremely hot immediately after using the cigarette lighter. The tip of the Cigarette Lighter Power Cable may melt or short circuit if it is plugged in while hot. Wait for the terminal to cool before plugging in the Cigarette Lighter Power Cable.
- Do not touch the lens with your hands. Wipe the lens off with a soft cloth if you touch it.

▲ Precautions When Handling the microSD Card

▲ CAUTION

- Keep the microSD card out of the reach of small children to prevent them from accidentally swallowing it.
- To prevent data loss and damage to the microSD card, never remove it from this product while data is being transferred.
- If data loss or corruption occurs on the microSD card for any reason, it is usually not possible to recover the

When Replacing the Fuse

Check if the fuse has blown when the power will not turn on or the battery cannot be charged even though the included Cigarette Lighter Power Cable is connected.

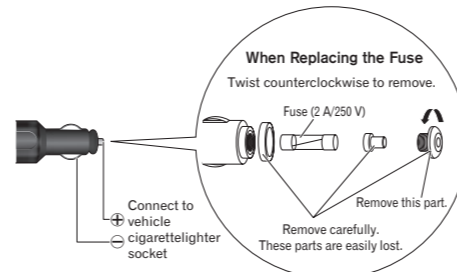

data. Pioneer accepts no liability for damages, costs or expenses arising from data loss or corruption.

- Never insert or eject a microSD card while driving.
- This product supports microSDHC cards (8 GB to 32 GB, Class 10). Not all microSDHC cards are guaranteed to work with this product.
- Format the microSD card before using it. Do not use a microSD card that contains other data, such as that from a PC.
- Do not eject the microSD card when it is being accessed. The file or card may be corrupted.
- Even if the microSD card is used normally, you may no longer be able to write data to the card or erase data from the card normally.
- The service life of the microSD card is not covered under the warranty.
- The microSD card is a consumable part. We recommend that you regularly replace the microSD card with a new card. If you use the microSD card for a long period of time, this product may no longer be able to save data to the card correctly due to bad sectors, or an error may occur and the card will no longer be usable.
- On rare occasions, a microSD card that is recognized by your computer may not be recognized by this product. In this case, depending on the problem with the microSD card, this product may be able to recognize the card by formatting it with this product format feature → *“System” - “Format SD card”*. However, all files, including protected files, saved to the microSD card will be erased when it is formatted. Always back up the files on the microSD card before formatting it.
- Pioneer Corporation does not make any assurances that microSD card problems will be repaired by formatting the card. Pioneer Corporation bears no responsibility for files that are erased from the microSD card or damage that occurs from formatting the card. Format the microSD card according to your own judgment and at your own responsibility.

Note

When the fuse has blown, replace the fuse with a new cartridge fuse (5.2 mm diameter/20 mm long), and firmly tighten the tip of the plug. Always replace the fuse with a fuse of the specified capacity (2 A/250 V).

Check the Accessories

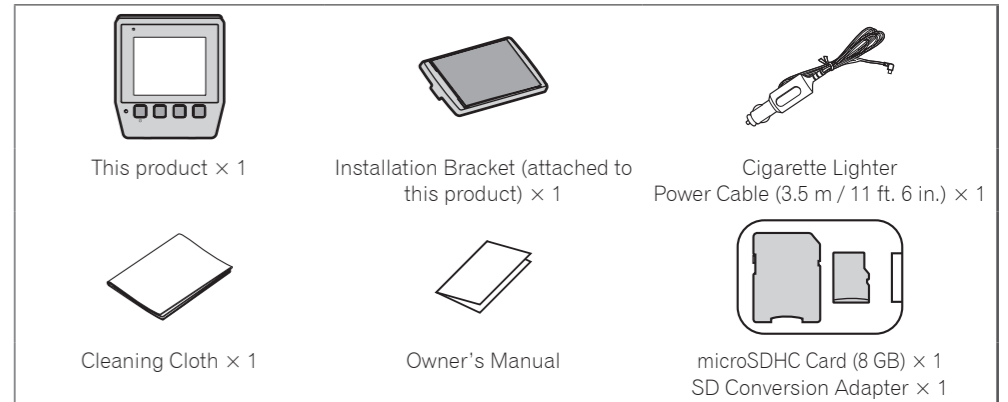

Before Installing the Product

▲ CAUTION

- First check with the vehicle manufacturer for precautions related to the installation work when installing the product in a vehicle equipped with airbags. Otherwise there is a risk of airbag malfunction.
- Always use the included parts as specified. There is a risk of product failure if other parts are used.
- Install this product in a location where it will not hinder vehicle equipment and the ability to drive the vehicle.

Installation Tips

Before Installing and Securing the Product

- First, temporarily connect this product and confirm that it operates correctly, and then install it. If the product does not operate correctly, check again if there is a mistake in the connection.

Before Applying Double-sided Tape

- Clean the location where the double-sided tape will be applied.

The double-sided tape cannot be reapplied once applied and peeled off because its adhesive power will weaken. Temporarily attach this product and carefully review the routing of the cable before applying the double-sided tape.

Installation Precautions

- This product is for installation to the front windshield only. Do not install it anywhere else inside or outside of the vehicle.
- Always install this product to the specified position of the front windshield and within the specified dimensions.
- Depending on the vehicle, it may not be possible to install this product to the specified position and within the specified dimensions. Consult with your dealer or the nearest authorized Pioneer Service Station for details.
- Do not cover this product or get the lens dirty.
- Do not place reflective objects near the lens.
- Take care when handling this product so that it does not drop and you do not touch the lens.
- Recording quality may be affected if the front windshield of the vehicle is coated or has been specially treated.
- This product may not be able to receive GPS signals if the front windshield of the vehicle has been specially treated.
- Check the GPS reception status indicator displayed on the screen of this product. If a GPS signal cannot be received, this product cannot be installed in this vehicle. → *“Using this product” - “Status Display”*
- Choose a working location free from dust and debris in the air.
- When the temperature is low or there is condensation on the glass, turn on the heater and defroster to warm up the window in order to prevent poor adhesion of the double-sided tape.

Installation

Specified Installation Position

- Install this product in a vehicle and at a position that satisfies all of the following conditions.
 - A position where the lens of this product is in the area swept by the windshield wipers.
 - A position where the lens of this product is not affected by the sun visor and frit band.
 - A position where this product faces in the horizontal direction to the front and side to side.
 - A position where the Cigarette Lighter Power Cable can easily reach the socket.
- This product must be slid to the left to remove it from the bracket after installation to the front windshield. If this product is installed too close to the rear view mirror when it is installed on the right side of the rear view mirror in a left-hand drive vehicle, you will not be able to remove it from the bracket.

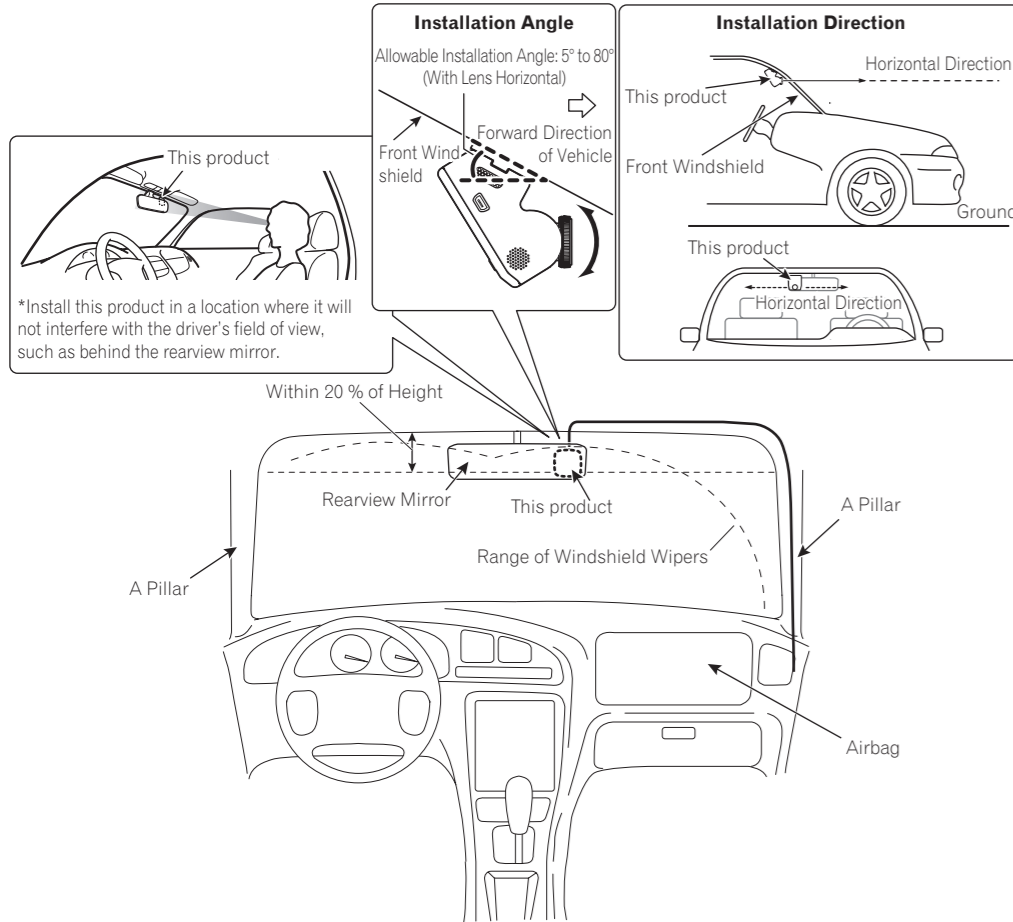

IMPORTANT

Always install this product in the specified installation position to ensure a safe field of view while driving and to achieve full performance from the product.

1 Clean the installation area of dirt and oils using the included cleaning cloth.

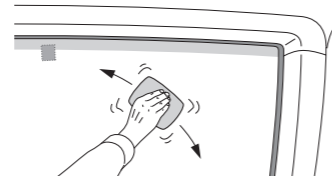

2 Install this product.

Peel off the sticker on the Installation Bracket (①) and attach this product to the front windshield. Firmly push the top of the product and both sides of the LCD (②). Never touch the surface of the LCD.

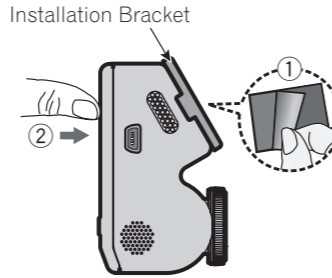

Use extreme care as the double-sided tape on the Installation Bracket in (①) is extremely strong, and it will be difficult to reapply the tape once it has been applied.

3 Route the cable.

Route the Cigarette Lighter Power Cable to the passenger seat side.

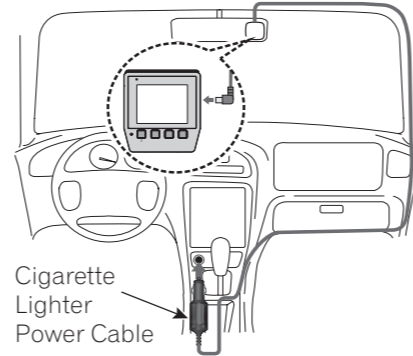

The power terminal will be extremely hot immediately after using the cigarette lighter. The tip of the Cigarette Lighter Power Cable may melt or short circuit if it is plugged in while hot. Wait for the terminal to cool before plugging in the Cigarette Lighter Power Cable.

4 Adjust the angle of the lens.

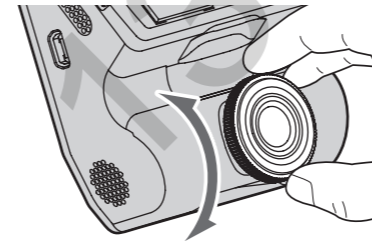

Note

A protective film is applied to the lens when the product is purchased. Peel off this film.

Removing this product

The Installation Bracket is attached to this product when the product is purchased. After this product is installed in the vehicle, remove this product from the Installation Bracket with the following steps.

1 Slide this product to the left as viewed from the LCD of this product.

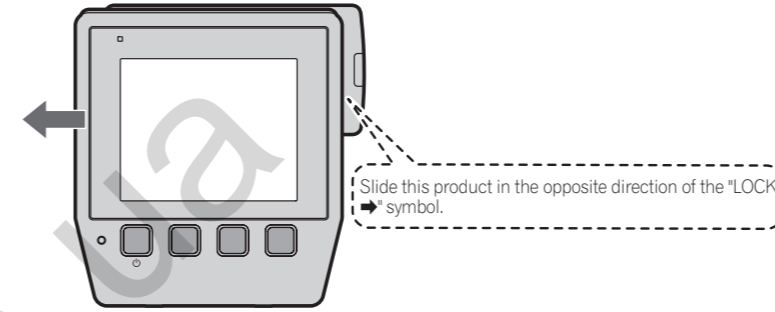

2 Remove this product so that the hooks on the Installation Bracket disengage from the slots on this product.

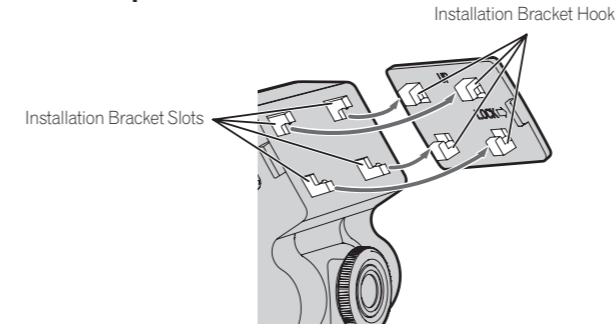

Reverse the steps to reattach this product. Line up and fit together the hooks on the Installation Bracket with the slots on this product, then slide this product to the right as viewed from the LCD (the direction indicated by the "LOCK" symbol on the Installation Bracket).

Part Names

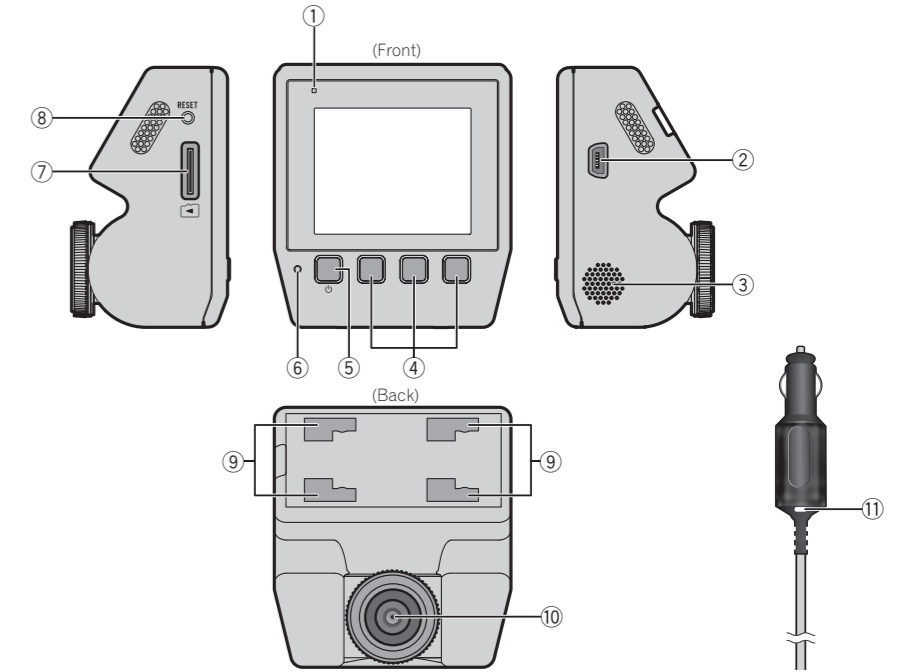

① System Indicator

② Mini USB Terminal (mini-B type)

The Cigarette Lighter Power Cable is connected to this terminal. You can also connect this product to your computer with a commercially available USB cable.

③ Speaker

④ Function Buttons

⑤ Power Button/Function Button

⑥ Microphone

⑦ microSD Card Slot

⑧ Reset Button

Press this button with the tip of a ballpoint pen to reset this product. (When the product is reset, the power turns off. To turn the power back on, press and hold the power button.)

⑨ Installation Bracket Slots

⑩ Lens

⑪ Indicator

The indicator is illuminated when powered.

Inserting and Ejecting the microSD Card

Turn off the power to this product when inserting and removing the microSD card.

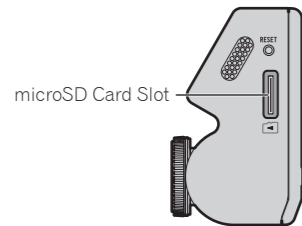

Inserting the microSD Card

Hold the top edge of the microSD card, position the microSD card so that the label is facing the backside of this product, and slowly insert it into the microSD card slot until it clicks.

Ejecting the microSD Card

Slowly push in the top edge of the microSD card until it clicks. The lock will be released. Pull out the microSD card.

Playing Files on a PC

You can play the files on the microSD card with your PC by inserting the microSD card ejected from this product into your PC, using the included SD Conversion Adapter if necessary.

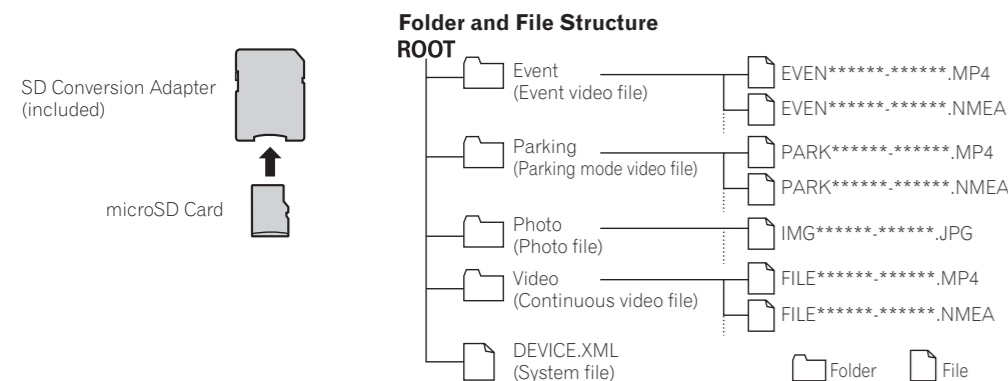

Notes

- The file name is automatically assigned a name using the year, month, day, hours, minutes, and seconds.
- Files with the extension ".NMEA" are administration files.
- Files can be played on your PC by connecting this product and PC with a commercially available USB cable.
- This product does not support USB 3.0.

Using this product

Before using this product, first stop the vehicle in a safe location and apply the parking brake.

This product Power

This product starts when the vehicle's engine is turned on (ACC ON), and it automatically starts recording. (Continuous recording)

The recorded video is saved to the microSD card as one file of the set increment of time, and when the microSD card runs out of free space, the files are overwritten starting from the oldest file.

CAUTION

- This product may not start when the engine is started if the internal battery is discharged or insufficiently charged. Start this product with the following methods when it does not start.
 - Press the power button on this product.
 - Charge this product and let it sit for about three minutes. Then unplug the plug of the Cigarette Lighter Power Cable from the cigarette power socket and plug it back in.

Notes

- Continuous recording will stop under the following circumstances.
- When the settings menu is displayed
 - When the power supply is stopped
 - During event recording
 - When parking mode has started

Manually Turning the Power On and Off

To manually turn this product power on and off, press and hold the power button for two or more seconds.

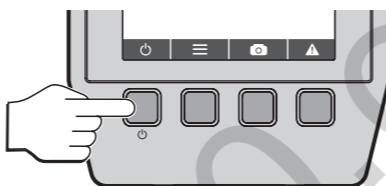

System Indicator Display

The operating status of this product is displayed with the system indicator.

System Indicator	Charging	Continuous Recording	Event/Parking Mode Recording
Illuminated green	○		
Illuminated red		○	
Illuminated amber			○

Check this product settings for the parking mode settings. → "This product Settings"

Function Buttons

The functions of the function buttons are indicated by the icons displayed at the bottom of the screen. The functions of the buttons will depend on the displayed screen.

Notes

- The following restrictions will occur when the product detects that the vehicle is moving faster than approx. 15 km/h. (Only when a GPS signal can be received.)
- The menu icon will be hidden.
 - The product switches to the recording state while the settings menu screen is displayed.

Recording



- Power off
- Display settings menu
- Take photo
- Record event

Settings menu

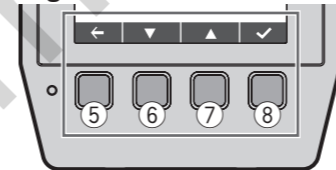

- Back
- Next settings screen
- Previous settings screen
- Confirm

Status Display

The status display shows the operating status of this product.



- Recording indicator**
This icon flashes during recording.
- Current time**
The time displayed here is recorded as the event recording time.
→ "System" - "Date/Time"
- GPS reception status**
The bars are green when receiving GPS signals. GPS signals cannot be received when the bars are white and a red x is displayed.
- Recording screen**

Notes

The following restrictions will occur when the product detects that the vehicle is moving faster than approx. 15 km/h. (Only when a GPS signal can be received.)

- If the monitor display is set to [Always On], the recording screen and the menu icon will be hidden.
- When the screen is off, the screen can be displayed by pressing any button.

Event Recording

Automatic Recording by Detecting Impacts (Event Recording)

The continuous video file when an impact was detected by this product, such as an impact with another vehicle, is saved to the "Event" folder as an event video file. The number of event video files and the recording time will depend on when the impact was detected.

When the impact was detected at the beginning of the file

When the impact was detected within 10 seconds of the start of the continuous video file, the current file where the impact was detected and the previous file (continuous video file 1 and 2 in the following diagram) are saved as the event video file.

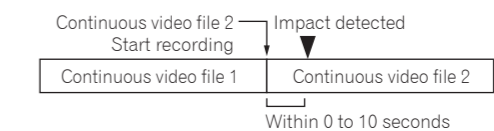

When the impact was detected at the end of the file

When the impact was detected in the 9 seconds before the end of the continuous video file, the file will be extended by 10 seconds of recording time and saved as the event video file. If an impact was detected during the extended period, a subsequent video file will be added and saved as an event video file. Video files will be repeatedly added while the impact continues.

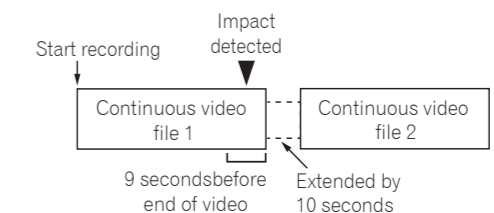

When the impact was detected at a time other than the beginning or end of the file

Only the continuous video file when the impact was detected is saved as the event video file.

Manual Recording (Manual Event Recording)

Switch to event recording by pressing the [▲] button during continuous recording. The recorded video is saved to the "Event" folder as an event video file. This product returns to continuous recording when event recording ends.

Notes

- Stop event recording by pressing the [■] button during event recording.
- The recording time can be set with "Video Clip Length".
→ "Video Recording" - "Video Clip Length"
- You can also adjust the sensitivity for detecting impacts.
→ "Video Recording" - "G-Sensor Sensitivity"

Parking Mode

Parking mode operates for a maximum of approximately 50 minutes after the power supplied to this product stops (the engine is turned off or the cigarette power cable is unplugged). If this product detects vibration or the movement of people/vehicles due to changes in the image, 20 seconds of video is recorded after the detected event.

Notes

- To use parking mode, under "Parking Mode", set "Parking Mode" to ON.
→ "Parking Mode" - "Parking Mode"
- You can adjust the sensitivity for detecting vibration.
→ "Parking Mode" - "G-Sensor Sensitivity"
- You can adjust the sensitivity for detecting the movement of people and vehicles.
→ "Parking Mode" - "Motion Detection"

Using this product

Before using this product, first stop the vehicle in a safe location and apply the parking brake.

Taking Photos

You can take a photo by pressing the  button during continuous recording.

Backing Up Recorded Files

When the free space of the file storage areas is low, recording proceeds by first deleting old files. We recommend that you back up any important files you want to keep with the following procedure.

Note

Prepare a spare microSD card in advance.

1 Replace the microSD card.

After recording a video or taking photos that you want to back up, first stop the vehicle in a safe location. Then turn off this product power, eject the microSD card, and replace it with a spare microSD card.

2 Copy or move the files to a PC.

Insert the microSD card into a PC, using the SD card adapter if necessary. Copy or move the videos and photo files to back up to a suitable location on the PC.

Note

For the folder and file structure → "Playing Files on a PC"

Playing Recorded Files

You can play recorded video files and view photo files.

1 Press the  button to open the settings menu.

2 Press the  /  function buttons, select [Playback], and then press .

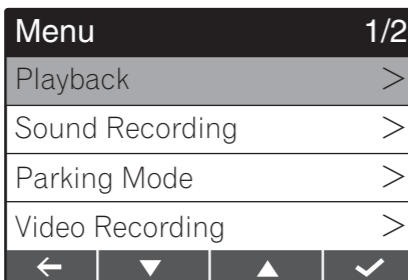

3 Press the  /  function buttons, select the folder, and then press .

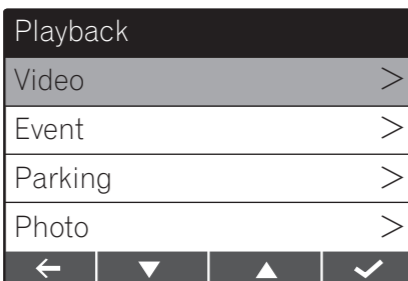

You can select the following folders.

- Video
- Event
- Parking
- Photo

The thumbnails of the selected folder will be displayed.



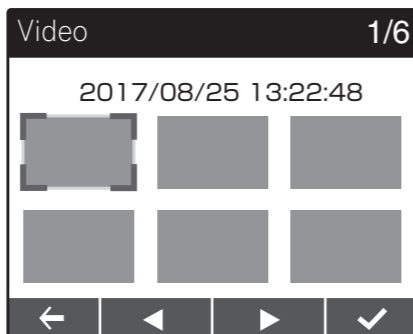



4 Press the  /  function buttons, select the file to play, and then press .



The selected file will play.

Note

You can perform the following operations by pressing the function buttons during playback.

- Press  to return to the thumbnails.
- Press  /  during video playback to play the previous/next movie. Press and hold the buttons to rewind or fast forward the video.
- Press  during video playback and a menu will be displayed that allows you to perform the following operations.
 - **Pause:** Pauses the video. Press again to start playback.
 - **Move to Event:** Moves the current video file to the event folder.
 - **Delete:** Deletes the current video file.
- Press  /  while viewing a photo to display the previous/next photo. Press  to delete the current photo.

This product Settings



Before using this product, first stop the vehicle in a safe location and apply the parking brake.

These settings configure this product. You can reset the settings to the default when the product is purchased. You can also format the microSD card and check this product version information. Note that continuous recording will stop while the setting screens are displayed.

1 Press the  button to open the settings menu.

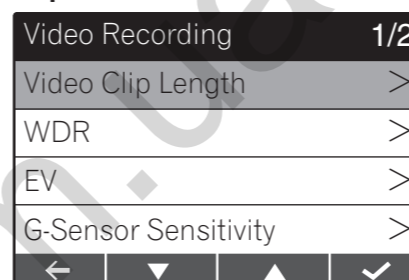
2 Press the  /  function buttons, select the setting, and then press .



3 Press the  /  function buttons, select the value for the setting, and then press .

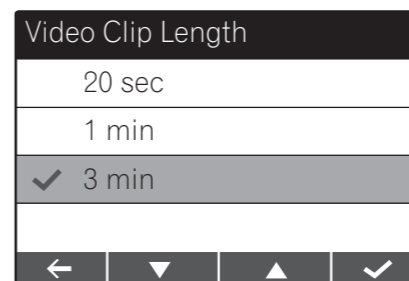

To complete the settings, press the  button until returning to the recording screen.

Configurable Features

Bold: Default setting value when the product is purchased.

Setting	Details	Values
Playback	Select [Video], [Event], [Parking], or [Photo] to play and delete recorded videos and photo files. → "Using this product" - "Playing Recorded Files"	
Sound Recording	Sets whether or not to record sound around this product when recording video files.	[ON]/[OFF]
Parking Mode	<p>Parking Mode</p> <p>Detection Method</p> <p>Auto Entry</p> <p>Motion Detection</p> <p>G-Sensor Sensitivity</p>	<p>[ON]/[OFF]</p> <p>[Both Motion & G-sensor]/ [Only G-sensor]/[Only Motion]</p> <p>[Easy]/[Medium]/[Difficult]/ [OFF]</p> <p>[Low]/[Medium]/[High]</p> <p>[Low]/[Medium]/[High]</p>

Setting	Details	Values	
Video Recording	<p>Video Clip Length</p> <p>WDR(Wide Dynamic Range)</p> <p>EV(Exposure Value)</p> <p>G-Sensor Sensitivity</p> <p>Speed Stamp</p> <p>Text Stamp</p>	<p>Sets the recording time for one continuous recording video file.* 1</p> <p>Sets use of the feature that automatically adjusts the image in situations where there is a large difference between light and dark.</p> <p>Sets the exposure level for adjusting image brightness.</p> <p>Sets the sensitivity for detecting vibration and impact during continuous recording.</p> <p>Sets whether or not to display the travel speed in the video file.</p> <p>Sets a maximum of 12 characters that will be displayed at the bottom right of the image when playing a video file.</p>	<p>[20 sec]/[1 min]/[3 min] * 3</p> <p>[ON]/[OFF]</p> <p>[-1]~[0]~[+1]</p> <p>[1]~[4]~[6]</p> <p>[ON]/[OFF]</p>
System	<p>Date/Time</p> <p>System Sound</p> <p>Volume</p> <p>LCD Standby</p> <p>Language</p> <p>Distance Unit</p> <p>SD card partition</p> <p>Restore to Defaults</p> <p>Version</p>	<p>Select [Use GPS time] or [Manual] and set the date and time. When [Use GPS time] is selected, the date and time will be automatically set using Greenwich Mean Time (GMT) received as a signal from the GPS satellites. When using [Use GPS time], set the time zone ([GMT-12:00] to [GMT+12:00]) and Daylight Saving Time for the region where the product will be used. (The default setting when the product is purchased is [GMT-06:00].)</p> <p>Sets whether or not to output alarm sounds and menu beeps.</p> <p>Sets the volume when playing video files.</p> <p>Sets the screen to be [Always On] or the time to display the screen.</p> <p>Sets the language used to display the screen.</p> <p>Sets the unit of distance/speed.</p> <p>Sets the percentage of memory to use for saving continuous video, events, parking mode video, and photos. → "Guide to Recording Time and No. of Photos"</p> <p>Restores all settings to the defaults when the product is purchased.</p> <p>Allows you to check the version information of this product firmware.</p>	<p>[Use GPS time]/[Manual]</p> <p>[ON]/[OFF]</p> <p>[1]~[3]~[5]</p> <p>[Always On]/ [10 sec screen off]/ [1 min screen off]/ [3 min screen off]</p> <p>[English]/[繁體中文]/[简体中文]/ [Русский]/[Nederlands]/ [Français]/[Deutsch]/[Español Mexicano]/[ไทย]/[Bahasa Indonesia]</p> <p>[Meter]/[Mile]</p> <p>[79% 10% 10% 1%]/ [59% 30% 10% 1%]/ [Last storage 20 clips 10 clips 400 pics]</p>
Format SD card		Formats the microSD card. All files on the card will be deleted.* 2	

*1 Approx. 20 seconds of video is recorded for parking mode videos. If vibrations or the movements of people and vehicles are detected during recording, the recording time will be extended approx. 20 seconds at a time up to a maximum of approx. 1 minute.

*2 If the microSD card experiences a problem, the "SD card error" screen will be displayed.

*3 In California in the United States of America, set this to 20 seconds to comply with state laws.

Guide to Recording Time and No. of Photos

The following table provides estimates of the video recording times and number of photos possible with different "SD card partition" settings. The actual values will depend on various factors, such as the microSD card being used, subject being recorded, and recording conditions.

The "SD card partition" setting is expressed as follows.

Example: [79% 10% 10% 1%]

As a percentage of memory card capacity, the continuous recording time will be 79%, the event recording time will be 10%, the parking mode time will be 10%, and the number of photos will be 1%.

Guide to Recording Time and No. of Photos with an 8 GB microSD Card

SD card partition	Continuous Recording	Event Recording	Parking Mode Recording	No. of Photos
[79% 10% 10% 1%]	Approx. 1 hours 9 minutes	Approx. 6 minutes	Approx. 7 minutes	Approx. 500 photos
[59% 30% 10% 1%]	Approx. 45 minutes	Approx. 24 minutes	Approx. 7 minutes	Approx. 500 photos
Remaining capacity*1	Approx. 15 minutes	20 files	10 files	400 photos

Guide to Recording Time and No. of Photos with an 32 GB microSD Card

SD card partition	Continuous Recording	Event Recording	Parking Mode Recording	No. of Photos
[79% 10% 10% 1%]	Approx. 4 hours 47 minutes	Approx. 33 minutes	Approx. 35 minutes	Approx. 2 000 photos
[59% 30% 10% 1%]	Approx. 3 hours 35 minutes	Approx. 1 hour 48 minutes	Approx. 35 minutes	Approx. 2 000 photos
Remaining capacity*1	Approx. 5 hours	20 files	10 files	400 photos

*1 This setting saves 20 files for event recording, 10 files for parking mode recording, 400 photos, and continuous recordings in the remaining memory.

Guide to Recording Time When Fully Charged

Parking mode standby time: Maximum of approx. 50 minutes

Guide to Charging Time

Approx. 3 hours

Note

The recording times are estimates. The actual recording times will depend on the scenery being recorded and charge status of the battery.

GPS

- GPS (Global Positioning System) is a system that measures your current position by receiving position measurement radio signals from GPS satellites.
- The GPS satellite signals cannot pass through solid matter (except glass). The signals from GPS satellites may be blocked when this product is in the following locations.
 - Inside tunnels and parking structures
 - On the bottom level of a two-level highway
 - Around concentrations of skyscrapers
 - In a dense forest

Trademarks & Copyrights

- microSDHC logo is a trademark of SD-3C, LLC.



Troubleshooting

Check the following information before sending the product in for repairs.

Symptom	Cause	Action
An error occurred during the display and operation of the this product .	The microcomputer in this product is malfunctioning.	Press the reset button.
A file that should have been saved cannot be found.	If there is insufficient space in the storage areas of the microSD card, the files will be overwritten in order from the oldest files.	We recommend that you back up any important files you want to keep. → "Using this product" - "Backing Up Recorded Files"
The product makes parking mode files when I get in and out of the vehicle.	The vibration when people get in and out of the vehicle and the movement of people are being detected.	Adjust the combination of sensors and their sensitivity. → "Parking Mode" - "Detection Method", "G-Sensor Sensitivity", "Motion Detection"
There are many videos where nothing happens in the files recorded while parked.	The sensitivity of vibration detection and motion detection may not be appropriate.	Adjust the combination of sensors and their sensitivity. → "Parking Mode" - "Detection Method", "G-Sensor Sensitivity", "Motion Detection"
My vehicle was hit while parked, but a video file wasn't made.	This may be due to the service life of the battery.	Please consult with the nearest authorized Pioneer Service Station.
An accident occurred during driving, but a video file wasn't made.	The sensitivity of impact detection may not be appropriate.	Adjust the sensitivity of vibration detection. → "Video Recording" - "G-Sensor Sensitivity"
There's no sound when I play a video file.	The sound recording setting may be OFF.	Check the sound recording setting again. → "Sound Recording"

WARNING/DISPOSAL OF UNIT (For American Users, Canadian Users)

Please do NOT attempt to change the battery yourself. If the battery has died and you do not want us to replace your battery, you should follow the disposal instructions below:

- Never dispose of used batteries/electronics with ordinary solid wastes, since they contain toxic substances.
- Always dispose of used batteries/electronics in accordance with the prevailing community regulations that apply to the disposal of batteries/electronics. If there are no local regulations concerning battery/electronics disposal, please dispose of the device in a waste bin for electronic devices.
- Many electronics retailers now recycle batteries and other electronic components at no charge. Check to see which ones in your area do so.

Please Recycle the Rechargeable Battery (For other than American and Canadian Users)

This product uses a lithium ion battery. Lithium ion batteries are a valuable resource that can be recycled. Remove the lithium ion battery from the product when replacing the battery or disposing of the product and recycle it. Remove the lithium ion battery from the product with the following procedure when disposing of the product.

CAUTION

- The purpose of this section is to describe how to remove the internal battery when disposing of the product. This product warranty will be void when you open the product.
- Fully discharge the internal battery before removing it to prevent short circuits. The battery still retains a charge even when the power does not turn on. We recommend that you leave the product for a number of days before removing the battery.
- Eject the microSD card before removing the battery.
- Be careful not to injure yourself when disassembling the case.

- 1 Remove the two screws on the bottom of this product.



Note

Remove the screws with a commercially available #0 Phillips screwdriver.

- 2 Release the four hooks that hold the display side of the case.

The locations of the hooks are shown in the following diagram.

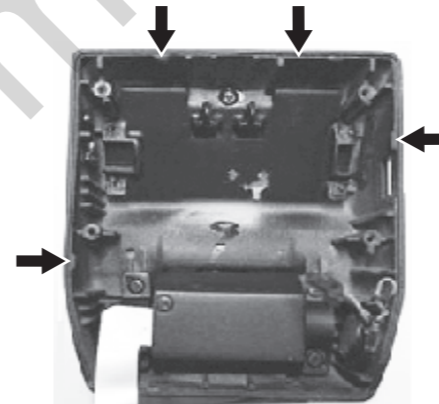

Note

The hooks can be released with a flathead screwdriver.

- 3 Disconnect the display-side connector.

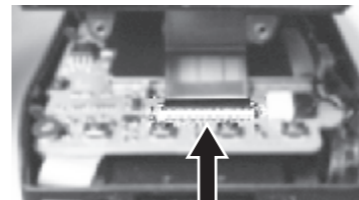

- 4 Disconnect the speaker connector, and remove the four screws holding the board.

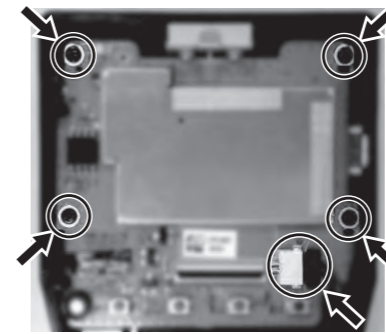

- 5 Lift up the board, disconnect the connector, and remove the battery.

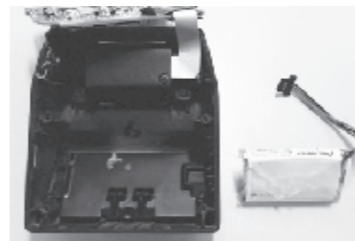
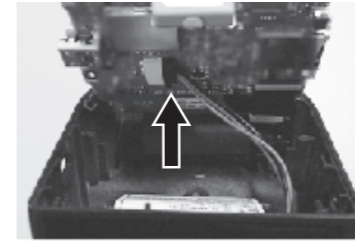

CAUTION

The battery is attached with double-sided tape. If the battery is difficult to remove, insert a flathead screwdriver in between the battery and case to remove it. Be careful not to damage the battery when doing so.

Specifications

Recording Medium	microSDHC card, Class 10 (8 GB to 32 GB)
Imaging Element	CMOS sensor, 2.07 million pixels
Recording Angles	95° horizontal, 52° vertical, 111° diagonal
F-Number	F2.0
Recording Resolution	Full HD (1 920 × 1 080 pixels)
GPS	Built-in
G-Sensor	3-axis G-sensor (During event recording: level can be set in 6 steps/ during parking mode: level can be set in 3 steps)
Recording Methods	Continuous recording/event recording/manual event recording/ parking mode recording
Video File Structure	20 sec/1 min/3 min
Display	2-inch LCD
Sound Recording	Can be set to ON or OFF
Frame Rate	27.5 fps
Compression Method (Video)	MP4 (H.264 + ADPCM codec)
Compression Method (Photo)	JPEG
Power Supply Voltage	This product 5 VDC (includes a 12 V/24 V Cigarette Lighter Power Cable)
Power Consumption	1.8 W (2.8 W when charging)
Dimensions (W × H × D)	61 mm × 67 mm × 39.2 mm (2-3/8 in. × 2-5/8 in. 1-1/2 in.) (This product)
Weight	87 g(1.9 lbs) (excluding the Installation Bracket and Cigarette Lighter Power Cable, etc.)
Operating Temperature	-10 °C to +60 °C (-50 °F to +140 °F)
Internal Battery Capacity	500 mAh

Note

Specifications and design are subject to possible modifications without notice due to improvements.