



PHONES

0 (800) 800 130
(050) 462 0 130
(063) 462 0 130
(067) 462 0 130

130
COM.UA

Internet store of
autogoods



SKYPE

km-130

CAR RECEIVERS — Receivers • Media receivers and stations • Native receivers • CD/DVD changers • FM-modulators/USB adapters • Flash memory • Facia plates and adapters • Antennas • Accessories |
 CAR AUDIO — Car audio speakers • Amplifiers • Subwoofers • Processors • Crossovers • Headphones • Accessories | TRIP COMPUTERS — Universal computers • Model computers • Accessories |
 GPS NAVIGATORS — Portable GPS • Built-in GPS • GPS modules • GPS trackers • Antennas for GPS navigators • Accessories | VIDEO — DVR • TV sets and monitors • Car TV tuners • Cameras • Videomodules
 • Transcoders • Car TV antennas • Accessories | SECURITY SYSTEMS — Car alarms • Bike alarms • Mechanical blockers • Immobilizers • Sensors • Accessories | OPTIC AND LIGHT — Xenon • Bixenon • Lamps
 • LED • Stroboscopes • Optic and Headlights • Washers • Light, rain sensors • Accessories | PARKTRONICS AND MIRRORS — Rear parktronic • Front parktronic • Combined parktronic • Rear-view mirrors
 • Accessories | HEATING AND COOLING — Seat heaters • Mirrors heaters • Screen-wipers heaters • Engine heaters • Auto-refrigerators • Air conditioning units • Accessories | TUNING — Vibro-isolation
 • Noise-isolation • Tint films • Accessories | ACCESSORIES — Radar-detectors • Handsfree, Bluetooth • Windowlifters • Compressors • Beeps, loudspeakers • Measuring instruments • Cleaners • Car seats
 • Miscellaneous | MOUNTING — Installation kits • Upholstery • Grilles • Tubes • Cable and wire • Tools • Miscellaneous | POWER — Batteries • Converters • Start-charging equipment • Capacitors
 • Accessories | MARINE AUDIO AND ELECTRONICS — Marine receivers • Marine audio speakers • Marine subwoofers • Marine amplifiers • Accessories | CAR CARE PRODUCTS — Additives • Washer fluid •
 Care accessories • Car polish • Flavors • Adhesives and sealants | LIQUID AND OIL — Motor oil • Transmission oil • Brake fluid • Antifreeze • Technical lubricant



In store "130" you can find and buy almost all necessary goods for your auto in Kyiv and other cities, delivery by ground and postal services. Our experienced consultants will provide you with exhaustive information and help you to choose the very particular thing. We are waiting for you at the address

<https://130.com.ua>

Pioneer

Operation Manual

CD RDS RECEIVER

DEH-80PRS



Made for



iPod



iPhone



English

Thank you for purchasing this PIONEER product.

To ensure proper use, please read through this manual before using this product. It is especially important that you read and observe **WARNING**s and **CAUTION**s in this manual. *Please keep the manual in a safe and accessible place for future reference.*

01 Before you start

- Information to User **3**
- The Safety of Your Ears is in Your Hands **3**
- About this unit **4**
- After-sales service for Pioneer products **4**
- In case of trouble **5**
- Visit our website **5**
- Resetting the microprocessor **5**
- Switching the DSP setting mode **5**
- Switching between RCA input modes **6**
- Demo mode **6**
- About this manual **6**

- Bluetooth profiles **47**
- Copyright and trademark **47**
- Specifications **49**

02 Operating this unit

- Head unit **7**
- Remote control **7**
- Set up menu **8**
- Basic operations **8**
- Use and care of the remote control **9**
- Menu operations identical for function settings/audio adjustments/initial settings/lists **10**
- Tuner **10**
- CD/CD-R/CD-RW and external storage devices (USB, SD) **12**
- iPod **15**
- Using Pandora® **17**
- Audio adjustments **19**
- Using Bluetooth wireless technology **31**
- Initial settings **35**
- Other functions **37**

Additional information

- Troubleshooting **40**
- Error messages **41**
- Handling guidelines **43**
- Compressed audio compatibility (disc, USB, SD) **45**
- iPod compatibility **46**
- Sequence of audio files **46**

Before you start

FCC ID: AJDK047

MODEL NO.: DEH-80PRS

IC: 775E-K047

This device complies with Part 15 of FCC Rules and Industry Canada licence-exempt RSS standard(s). Operation is subject to the following two conditions: (1) this device may not cause interference, and (2) this device must accept any interference, including interference that may cause undesired operation of this device. This transmitter must not be co-located or operated in conjunction with any other antenna or transmitter.

The antenna for Bluetooth cannot be removed (or replaced) by user.

This equipment complies with FCC/IC radiation exposure limits set forth for an uncontrolled environment and meets the FCC radio frequency (RF) Exposure Guidelines in Supplement C to OET65 and RSS-102 of the IC radio frequency (RF) Exposure rules. This equipment has very low levels of RF energy that it deemed to comply without maximum permissive exposure evaluation (MPE). But it is desirable that it should be installed and operated keeping the radiator at least 20 cm or more away from person's body (excluding extremities: hands, wrists, feet and ankles).

Note

This equipment has been tested and found to comply with the limits for a Class B digital device, pursuant to Part 15 of the FCC Rules. These limits are designed to provide reasonable protection against harmful interference in a residential installation. This equipment generates, uses and can radiate radio frequency energy and, if not installed and used in accordance with the instructions, may cause harmful interference to radio communications. However, there is no guarantee that interference will not occur in a particular installation. If this equipment does cause harmful interference to radio or television reception, which can be determined by turning the equipment off and on, the user is encouraged to try to correct the interference by one or more of the following measures:

- Reorient or relocate the receiving antenna.
- Increase the separation between the equipment and receiver.
- Connect the equipment into an outlet on a circuit different from that to which the receiver is connected.
- Consult the dealer or an experienced radio/TV technician for help.

Information to User

Alteration or modifications carried out without appropriate authorization may invalidate the user's right to operate the equipment.

The Safety of Your Ears is in Your Hands

Get the most out of your equipment by playing it at a safe level—a level that lets the sound come through clearly without annoying blaring or distortion and, most importantly, without affecting your sensitive hearing. Sound can be deceiving. Over time, your hearing “comfort level” adapts to higher volumes of sound, so what sounds “normal” can actually be loud and harmful to your hearing. Guard against this by setting your equipment at a safe level BEFORE your hearing adapts.

Before you start

ESTABLISH A SAFE LEVEL:

- Set your volume control at a low setting.
- Slowly increase the sound until you can hear it comfortably and clearly, without distortion.
- Once you have established a comfortable sound level, set the dial and leave it there.

BE SURE TO OBSERVE THE FOLLOWING GUIDELINES:

- Do not turn up the volume so high that you can't hear what's around you.
- Use caution or temporarily discontinue use in potentially hazardous situations.
- Do not use headphones while operating a motorized vehicle; the use of headphones may create a traffic hazard and is illegal in many areas.

About this unit

The tuner frequencies on this unit are allocated for use in North America. Use in other areas may result in poor reception.

WARNING

Handling the cord on this product or cords associated with accessories sold with the product may expose you to chemicals listed on proposition 65 known to the State of California and other governmental entities to cause cancer and birth defect or other reproductive harm. **Wash hands after handling.**

CAUTION:
USE OF CONTROL OR ADJUSTMENT OR PERFORMANCE OF PROCEDURES OTHER THAN THOSE SPECIFIED HEREIN MAY RESULT IN HAZARDOUS RADIATION EXPOSURE.

CAUTION:
THE USE OF OPTICAL INSTRUMENTS WITH THIS PRODUCT WILL INCREASE EYE HAZARD.

CAUTION

- Do not allow this unit to come into contact with liquids. Electrical shock could result. Also, damage to this unit, smoke, and overheating could result from contact with liquids.
- Always keep the volume low enough to hear outside sounds.
- Avoid exposure to moisture.
- If the battery is disconnected or discharged, any preset memory will be erased.

Important (Serial number)

The serial number is located on the bottom of this unit. For your own security and convenience, be sure to record this number on the enclosed warranty card.

Note

Function setting operations are completed even if the menu is cancelled before the operations are confirmed.

After-sales service for Pioneer products

Please contact the dealer or distributor from where you purchased this unit for after-sales service (including warranty conditions) or any other information. In case the necessary information is not available, please contact the companies listed below:

Please do not ship your unit to the companies at the addresses listed below for repair without advance contact.

Before you start

U.S.A.

Pioneer Electronics (USA) Inc.
CUSTOMER SUPPORT DIVISION
P.O. Box 1760
Long Beach, CA 90801-1760
800-421-1404

CANADA

Pioneer Electronics of Canada, Inc.
CUSTOMER SATISFACTION DEPARTMENT
340 Ferrier Street
Unit 2
Markham, Ontario L3R 2Z5, Canada
1-877-283-5901
905-479-4411

For warranty information please see the Limited Warranty sheet included with this unit. 

In case of trouble

Should this unit fail to operate properly, please contact your dealer or nearest authorized PIONEER Service Station. 

Visit our website

<http://www.pioneerelectronics.com>
in Canada

<http://www.pioneerelectronics.ca>

- Learn about product updates (such as firmware updates) for your product.
- Register your product to receive notices about product updates and to safeguard purchase details in our files in the event of loss or theft.
- Access owner's manuals, spare parts information, service information, and much more. 

Resetting the microprocessor

The microprocessor must be reset in the following situations:

- Before using this unit for the first time after installation
- If the unit fails to operate properly
- When strange or incorrect messages appear on the display

1 Remove the front panel.

For details, refer to *Removing the front panel to protect your unit from theft* on page 9.

2 Press RESET with a pen tip or other pointed instrument.

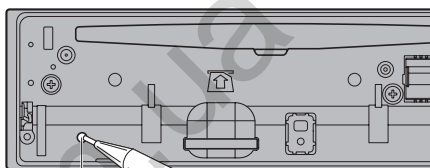

RESET button 

Switching the DSP setting mode

This unit features two operation modes: the 3-way network mode (NW) and the standard mode (STD). You can switch between modes as desired. Initially, the DSP setting is set to the standard mode (STD).

- After switching, reset the microprocessor.

WARNING

Do not use the unit in standard mode when a speaker system for 3-way network mode is connected to this unit. This may cause damage to the speakers.

Before you start

1 Use a thin, flathead screwdriver to change the DSP switch on the bottom of this unit.

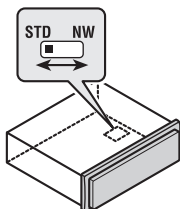

2 Press RESET with a pen tip or other pointed instrument.

Note

This unit's audio settings will continue to remain in the memory even if the battery is disconnected or the microprocessor reset. If you want to reset the audio settings, refer to **AUDIO reset** (*audio reset*) on page 36.

Switching between RCA input modes

If you connect the unit to an audio device with RCA output, or to one with no RCA output, you can set it up so that the audio from the audio device is output through speakers connected to the unit. Change settings as necessary based on whether the connected device has RCA output or not.

- For more details on how to connect the unit, refer to the installation manual.
- **Use a thin, flathead screwdriver to change the RCA input mode switch on the bottom of this unit.**

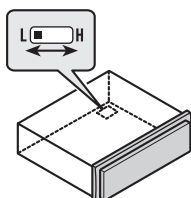

- **L** (Low) - If inputting from the RCA output of a connected device
- **H** (High) - If inputting from the speaker output of a connected device

Demo mode

Important

- Failure to connect the red lead (ACC) of this unit to a terminal coupled with ignition switch on/off operations may lead to battery drain.
- Remember that if the feature demo continues operating when the car engine is turned off, it may drain battery power.

The demo starts automatically if you do not operate this unit within about 30 seconds since it was last operated or if the ignition switch is set to ACC or ON while it is turned off. To cancel the demo mode, press and hold (➡/DISP). Press and hold (➡/DISP) again to start. You can also deactivate demo mode in the initial settings. Select **Demonstration** (*demo display setting*) and turn off the demo display. For details, refer to *Initial settings* on page 35.

About this manual

- In the following instructions, USB memories, USB portable audio players, and SD memory cards are collectively referred to as "external storage devices (USB, SD)". If only USB memories and USB portable audio players are indicated, they are collectively referred to as "USB storage devices".
- In this manual, iPod and iPhone will be referred to as "iPod".

Operating this unit

Head unit

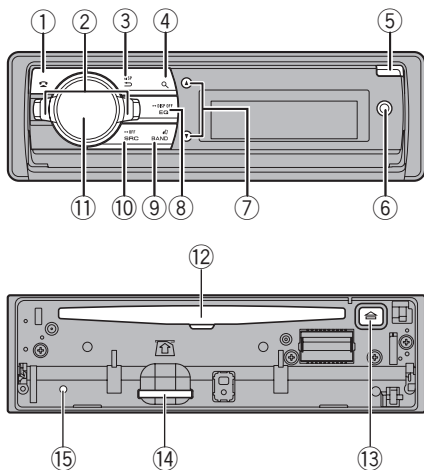

Part	Part
① (phone/on hook)	⑨ BAND/ (iPod)
② LEVER	⑩ SRC/OFF
③ DISP	⑪ MULTI-CONTROL (M.C.)
④ (list)	⑫ Disc loading slot
⑤ Open button	⑬ (eject)
AUX input jack (3.5 mm stereo jack)	SD memory card slot
⑥ Auto TA and EQ microphone input jack	⑭ Remove the front panel to access the SD memory card slot.
⑦	⑮ RESET
⑧ EQ/DISP OFF	

CAUTION

Use a Pioneer USB cable when connecting the USB audio player/USB memory device as devices connected to the unit directly will protrude out, which is dangerous.

Do not use unauthorized products.

Remote control

Remote controller buttons marked with the same numbers as on the unit operate in the same way as the corresponding unit button regardless of button name.

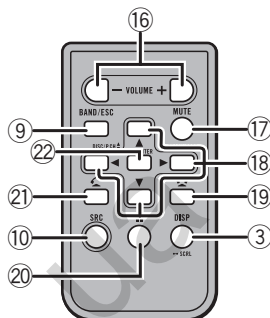

Part	Operation
⑯ VOLUME	Press to increase or decrease volume.
⑰ MUTE	Press to mute. Press again to unmute.
⑱	Press to perform manual seek tuning, fast forward, reverse and track search controls. Also used for controlling functions.
⑲	While operating the phone, press to end a call or reject an incoming call.
⑳ 	Press to pause or resume playback.
㉑	Press to start talking on the phone while operating a phone.
㉒ LIST/ENTER	Press to display the disc title, track title, folder, or file list depending on the source. While in the operating menu, press to control functions.



Set up menu

When you turn the ignition switch to ON after installation, set up menu appears on the display.

You can set up the menu options below.

1 After installation of this unit, turn the ignition switch to ON.

SET UP appears.

2 Turn **M.C.** to switch to **YES**.

- If you do not operate for 30 seconds, the set up menu will not be displayed.
- If you prefer not to set up at this time, turn **M.C.** to switch to **NO**.

If you select **NO**, you cannot set up in the set up menu.

3 Press **M.C.** to select.

4 Perform the following procedures to set the menu.

To proceed to the next menu option, you need to confirm your selection.

Language select (multi-language)

- 1 Turn **M.C.** to select the desired language.
English—Français—Español
- 2 Press **M.C.** to confirm the selection.

Calendar (setting the date)

- 1 Turn **M.C.** to change the year.
- 2 Press **M.C.** to select day.
- 3 Turn **M.C.** to change the day.
- 4 Press **M.C.** to select month.
- 5 Turn **M.C.** to change the month.
- 6 Press **M.C.** to confirm the selection.

Clock (setting the clock)

- 1 Turn **M.C.** to adjust hour.
- 2 Press **M.C.** to select minute.
- 3 Turn **M.C.** to adjust minute.
- 4 Press **M.C.** to confirm the selection.

Contrast (display contrast setting)

- 1 Turn **M.C.** to adjust the contrast level.
0 to **15** is displayed as the level is increased or decreased.
- 2 Press **M.C.** to confirm the selection.

Demonstration (demo display setting)

- 1 Turn **M.C.** to set the demo display to off.
- 2 Press **M.C.** to confirm the selection.
Quit appears.

5 To finish your settings, turn **M.C.** to select **YES**.

- If you prefer to change your setting again, turn **M.C.** to switch to **NO**.

6 Press **M.C.** to select.

Notes

- Because demonstration mode is the function for displaying at stores, do not use this function while driving.
- You can set up the menu options in the initial settings. For details about the settings, refer to *Initial settings* on page 35.
- You can cancel set up menu by pressing **SRC/OFF**. 

Basic operations

Important

- Handle gently when removing or attaching the front panel.
- Avoid subjecting the front panel to excessive shock.
- Keep the front panel out of direct sunlight and high temperatures.
- To avoid damaging the device or vehicle interior, remove any cables and devices attached to the front panel before detaching it.

Operating this unit

Removing the front panel to protect your unit from theft

The front panel can be detached to deter theft.

① Press the open button to open the front panel.

② Grip the left side of the front panel and pull it gently outward.

Take care not to grip it too tightly or to drop the front panel and protect it from contact with water or other fluids to prevent permanent damage.

③ Always keep the detached front panel in a protection device such as a protection case.

Re-attaching the front panel

① Reattach the front panel by holding it upright to the unit and clipping it securely into the mounting hooks.

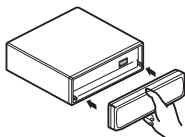

Turning the unit on

① Press **SRC/OFF** to turn the unit on.

Turning the unit off

① Press and hold **SRC/OFF** until the unit turns off.

Selecting a source

① Press **SRC/OFF** to cycle between:

TUNER (tuner)—**CD** (CD player)—**USB1** (USB1)/**iPod1** (iPod1)—**Pandora1** (Pandora1)—**USB2** (USB2)/**iPod2** (iPod2)—**Pandora2** (Pandora2)—**SD** (SD memory card)—**AUX1** (AUX1)—**AUX2** (AUX2)—**BT Audio** (BT audio)

Adjusting the volume

① Turn **M.C.** to adjust the volume.

communications for the USB storage device first before proceeding.

- If connecting both **USB1** (USB storage device1)/**iPod1** (iPod connected using USB input1) and **USB2** (USB storage device2)/**iPod2** (iPod connected using USB input2) at the same time, use a Pioneer USB cable (CD-U50E) in addition to the regular Pioneer USB cable.
- Set the application for Pandora to off when you select an iPod as the source. The source may be switched to Pandora automatically if the application is on.

Use and care of the remote control

Using the remote control

① Point the remote control in the direction of the front panel to operate.

When using for the first time, pull out the film protruding from the tray.

Replacing the battery

① Slide the tray out on the back of the remote control.

② Insert the battery with the plus (+) and minus (-) poles aligned properly.

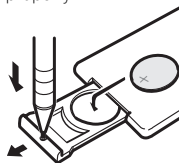

CAUTION

For safety reasons, park your vehicle when removing the front panel.

Notes

- When this unit's blue/white lead is connected to the vehicle's auto-antenna relay control terminal, the vehicle's antenna extends when this unit's source is turned on. To retract the antenna, turn the source off.
- When there are two USB storage devices connected to this unit and you want to switch between them for playback, disconnect

WARNING

- Keep the battery out of the reach of children. Should the battery be swallowed, consult a doctor immediately.
- Batteries (battery pack or batteries installed) must not be exposed to excessive heat such as sunshine, fire or the like.

CAUTION

- Use one **CR2025 (3 V)** lithium battery.

Operating this unit

- Remove the battery if the remote control is not used for a month or longer.
- There is a danger of explosion if the battery is incorrectly replaced. Replace only with the same or equivalent type.
- Do not handle the battery with metallic tools.
- Do not store the battery with metallic objects.
- If the battery leaks, wipe the remote control completely clean and install a new battery.
- When disposing of used batteries, comply with governmental regulations or environmental public institutions' rules that apply in your country/area.
- "Perchlorate Material – special handling may apply.
See www.dtsc.ca.gov/hazardouswaste/perchlorate. (Applicable to California, U.S.A.)"

Important

- Do not store the remote control in high temperatures or direct sunlight.
- The remote control may not function properly in direct sunlight.
- Do not let the remote control fall onto the floor, where it may become jammed under the brake or accelerator pedal. 

Menu operations identical for function settings/audio adjustments/initial settings/lists

Returning to the previous display
Returning to the previous list/category (the folder/category one level higher)

1 Press **DISP**.

Turning the demo display on or off

1 Press and hold **DISP**.

Returning to the ordinary display
Canceling the initial setting menu

1 Press **BAND/**.

Returning to the ordinary display from the list/category

1 Press **BAND/**.

Selecting a function or list

1 Turn **M.C.** or **LEVER**.

- In this manual, "Turn **M.C.**" is used to describe the operation used to select a function or list.



Tuner

Basic operations

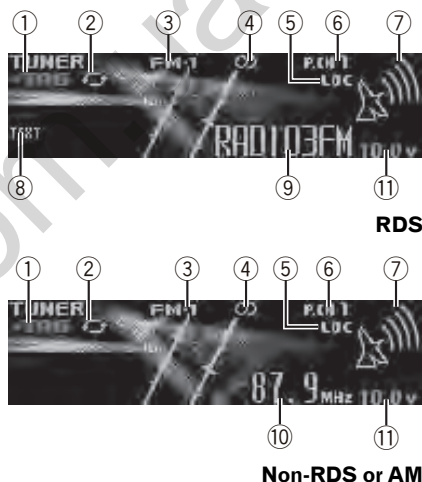

- 1 **TAG** indicator
- 2 Tags transferring indicator
- 3 Band indicator
- 4 (stereo) indicator
- 5 **LOC** indicator
Appears when local seek tuning is on.
- 6 Preset number indicator
- 7 Signal level indicator
- 8 **TEXT** indicator
Shows when the radio text is received.
- 9 Program service name
- 10 Frequency indicator
- 11 Voltage indicator
Shows the battery voltage.

Operating this unit

- The level displayed on the voltage indicator may differ from the actual voltage level.

<p>Selecting a band</p> <p>1 Press BAND/ until the desired band (FM-1, FM-2, FM-3 for FM or AM) is displayed.</p>
<p>Manual tuning (step by step)</p> <p>1 Turn LEVER.</p>
<p>Seeking</p> <p>1 Turn and hold down LEVER.</p> <ul style="list-style-type: none"> While turning and holding down LEVER, you can skip stations. Seek tuning starts as soon as you release LEVER.

Storing and recalling stations for each band

1 Press **Q** (list).

The preset screen is displayed.

2 Use **M.C.** to store the selected frequency in the memory.

Turn to change the preset number. Press and hold to store.

3 Use **M.C.** to select the desired station.

Turn to change the station. Press to select.

- All stations stored for FM bands can be recalled from each independent FM band.
- You can tune the channel up or down manually by pressing **▲** or **▼**.
- Press **BAND/** or **Q** (list) to return to the ordinary display.

Switching the display

Desired information can be displayed while tag information has been broadcasting.

<p>Selecting the desired text information</p> <p>1 Press DISP.</p> <p>Frequency or program service name—song title and artist name</p>

Using iTunes tagging

This function can be operated with the following iPod models.

- iPod touch 4th generation
- iPod touch 3rd generation
- iPod touch 2nd generation
- iPod touch 1st generation
- iPod classic 160GB
- iPod classic 120GB
- iPod classic
- iPod nano 6th generation
- iPod nano 5th generation
- iPod nano 4th generation
- iPod nano 3rd generation
- iPhone 4
- iPhone 3GS
- iPhone 3G
- iPhone

However, tag information can be stored in this unit even while other iPod models are used.

The song information (tag) can be saved from the broadcasting station to your iPod. The songs will show up in a playlist called “Tagged playlist” in iTunes the next time you sync your iPod. Then you can directly buy the songs you want from the iTunes Store.

- The tagged songs and the song that you can buy from the iTunes Store may be different. Make sure to confirm the song before you make the purchase.

<p>Storing the tag information to this unit</p> <p>1 Tune in to the broadcast station.</p> <p>2 Press and hold M.C. if TAG is indicated in the display while desired song is broadcasting.</p> <ul style="list-style-type: none"> While storing the tag data on this unit, TAG flashes.

<p>Storing the tagged information to your iPod</p> <p>1 Connect an iPod to the USB cable using an iPod Dock Connector.</p> <p>2 Select Tags transfer from the function settings to transfer tag information from this unit to the iPod. Refer to Tags transfer (Tags transfer) on page 17.</p> <ul style="list-style-type: none"> If you switch sources during tag transfer, the transfer will stop. To cancel the transfer, select Tags transfer from the function settings and then try transferring the tag information again.

Using radio text

Displaying radio text

You can display the currently received radio text and the three most recent radio texts.

- 1 Press and hold down **Q** (list) to display radio text.
 - You can turn off radio text display by pressing **DISP/SRC/OFF** or **BAND/**.
 - When no radio text is received, **NO TEXT** appears in the display.
- 2 Turn **LEVER** left or right to recall the three most recent radio texts.
- 3 Press **▲** or **▼** to scroll.

Storing and recalling radio text

You can store data from up to six radio text transmissions to the **RT Memo 1** to **RT Memo 6** keys.

- 1 Display the radio text you want to store in the memory.
- 2 Press **Q** (list).
The preset screen is displayed.
- 3 Use **LEVER** to store the selected radio text. Turn it to change the preset number. Press and hold down **M.C.** to store.
- 4 Use **LEVER** to select the desired radio text. Turn it to change the radio text. Press **M.C.** to select.
 - To return to the ordinary display, press **BAND/** or **Q** (list).

- The tuner automatically stores the three latest radio text broadcasts received, replacing the oldest text with the newest text.

Function settings

- 1 Press **M.C.** to display the main menu.
- 2 Turn **M.C.** to change the menu option and press to select **FUNCTION**.
- 3 Turn **M.C.** to select the function.

After selecting, perform the following procedures to set the function.

- If AM band is selected, only **BSM**, **Local** and **Tuning Mode** are available.

BSM (best stations memory)

BSM (best stations memory) automatically stores the six strongest stations in the order of their signal strength.

- 1 Press **M.C.** to turn BSM on.
To cancel, press **M.C.** again.

Local (local seek tuning)

Local seek tuning lets you tune in to only those radio stations with sufficiently strong signals for good reception.

- 1 Press **M.C.** to turn local on.
 - To cancel, press **M.C.** again.
- 2 Turn **LEVER** left or right to select the desired setting.

FM: **Level 1—Level 2—Level 3—Level 4**

AM: **Level 1—Level 2**

The highest level setting allows reception of only the strongest stations, while lower levels allow the reception of weaker stations.

Tuning Mode (LEVER tuning setting)

You can assign a function to the **LEVER** on the unit. Select **Manual** (manual tuning) to tune up or down manually or select **Preset** (preset channel) to switch between preset channels.

- 1 Press **M.C.** to select **Manual** or **Preset**.

CD/CD-R/CD-RW and external storage devices (USB, SD)

Basic operations

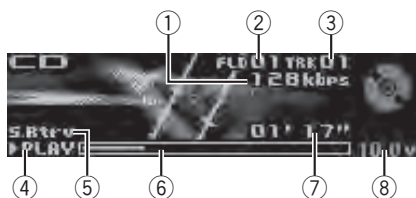

- 1 Bit rate/sampling frequency indicator
Shows the bit rate or sampling frequency of the current track (file) when the compressed audio is playing.
 - When playing back VBR (variable bit rate)-recorded AAC files, the average bit rate value is displayed. However, depending on the software used to decode AAC files, **VBR** may be displayed.
- 2 Folder number indicator
Shows the folder number currently playing when the compressed audio is playing.
- 3 Track number indicator
- 4 **PLAY/PAUSE** indicator
- 5 **S.Rtrv** indicator
Appears when Sound Retriever function is on.

Operating this unit

- ⑥ Song time (progress bar)
- ⑦ Play time indicator
- ⑧ Voltage indicator
 - Shows the battery voltage.
 - The level displayed on the voltage indicator may differ from the actual voltage level.

<p>Opening the front panel</p> <p>① Press the open button. Disc loading slot appears.</p>
<p>Playing a CD/CD-R/CD-RW</p> <p>① Insert the disc into the disc loading slot with the label side up.</p>
<p>Ejecting a CD/CD-R/CD-RW</p> <p>① Press ▲ (eject).</p>
<p>Playing songs on a USB storage device</p> <p>① Use a Pioneer USB cable to connect the USB storage device to the unit.</p> <ul style="list-style-type: none"> • Plug in the USB storage device using the USB cable.
<p>Stopping playback of files on a USB storage device</p> <ul style="list-style-type: none"> • You may disconnect the USB storage device at any time.
<p>Playing songs on an SD memory card</p> <p>① Remove the front panel. For details, refer to <i>Removing the front panel to protect your unit from theft</i> on page 9.</p> <p>② Insert an SD memory card into the SD card slot. Insert it with the contact surface facing down, and press on the card until it clicks and completely locks into place.</p> <p>③ Re-attach the front panel.</p> <p>④ Press SRC/OFF to select SD as the source. Playback will start.</p>
<p>Stopping playback of files on an SD memory card</p> <p>① Remove the front panel. For details, refer to <i>Removing the front panel to protect your unit from theft</i> on page 9.</p> <p>② Press on the SD memory card until it clicks. The SD memory card is ejected.</p> <p>③ Pull out the SD memory card.</p> <p>④ Re-attach the front panel.</p>
<p>Selecting a folder</p> <p>① Press ⏪ or ⏩.</p>
<p>Selecting a track</p> <p>① Turn LEVER.</p>
<p>Fast forwarding or reversing</p> <p>① Turn and hold down LEVER to the right or left.</p>

Returning to root folder

- ① Press and hold **BAND/⏪**.

Switching between compressed audio and CD-DA

- ① Press **BAND/⏪**.

Switching between playback memory devices

You can switch between playback memory devices on USB storage devices with more than one Mass Storage Device-compatible memory device.

- ① Press **BAND/⏪**.

- You can switch between up to 32 different memory devices.

Notes

- When playing compressed audio, there is no sound during fast forward or reverse.
- Disconnect USB storage devices from the unit when not in use.
- If there are two USB storage devices connected to this unit, the device connected to the input of the selected source is the one that is operated.
- Disconnect communications for the USB storage device before switching to operation of the other device.

Displaying text information

Selecting the desired text information

- ① Press **⇒/DISP**.

Notes

- Depending on the version of iTunes used to write MP3 files to a disc or media file types, incompatible text stored within an audio file may be displayed incorrectly.
- Text information items that can be changed depend on the media.

Selecting and playing files/tracks from the name list

If there are external storage devices (USB, SD) connected to the unit, this function is only available when **Music browse** is set to **OFF**. Refer to **Music browse** (*music browse*) on page 35.

- 1 Press **🔍 (list)** to switch to the file/track name list mode.

Operating this unit

2 Use M.C. to select the desired file name (or folder name).

Changing the file or folder name <ol style="list-style-type: none"> 1 Turn M.C. You can also perform this operation by turning LEVER.
Playing <ol style="list-style-type: none"> 1 When a file or track is selected, press M.C.
Viewing a list of the files (or folders) in the selected folder <ol style="list-style-type: none"> 1 When a folder is selected, press M.C.
Playing a song in the selected folder <ol style="list-style-type: none"> 1 When a folder is selected, press and hold M.C.

Browsing for a song

- This function is only available when a file on an external storage device (USB, SD) or a song on an iPod is being played.
- If there are external storage devices (USB, SD) connected to the unit, this function is only available when **Music browse** is set to **USB memory1**, **USB memory2** or **SD card**. Refer to **Music browse** (*music browse*) on page 35.

1 Press **Q** (list) to switch to the top menu of the list search.

2 Use M.C. to select a category/song.

Changing the name of the song or category <ol style="list-style-type: none"> 1 Turn M.C. Artists (artists)—Albums (albums)—Songs (songs)—Genres (genres) You can also perform this operation by turning LEVER.
Playing <ol style="list-style-type: none"> 1 When a song is selected, press M.C.
Viewing a list of songs in the selected category <ol style="list-style-type: none"> 1 When a category is selected, press M.C.
Playing a song in the selected category <ol style="list-style-type: none"> 1 When a category is selected, press and hold M.C.
Searching the list by alphabet <ol style="list-style-type: none"> 1 When a list for the selected category is displayed, press Q to switch to alphabet search mode. 2 Turn M.C. to select a letter. 3 Press M.C. to display the alphabetical list.

Notes

- This unit must create an index in order to facilitate **Artists**, **Albums**, **Songs**, and **Genres** searches. Typically, it will take approximately 70 seconds to create an index for 1 000 songs, and we recommend that up to 3 000 songs be used. Please note that certain types of file may take longer to index than others.
- Depending on the number of files in the USB storage device, there may be a delay when displaying a list.
- Keys may not have any effect during the creation of an index or list.
- Lists are recreated each time the unit is turned on.

Function settings

1 Press M.C. to display the main menu.

2 Turn M.C. to change the menu option and press to select FUNCTION.

3 Turn M.C. to select the function.

After selecting, perform the following procedures to set the function.

Play mode (repeat play)

- 1 Press **M.C.** to select a repeat play range.
CD/CD-R/CD-RW
 - **Disc repeat** – Repeat all tracks
 - **Track repeat** – Repeat the current track
 - **Folder repeat** – Repeat the current folder**External storage device (USB, SD)**
 - **All repeat** – Repeat all files
 - **Track repeat** – Repeat the current file
 - **Folder repeat** – Repeat the current folder

Random mode (random play)

- 1 Press **M.C.** to turn random play on or off.

Link play (link play)

Operating this unit

- 1 Press **M.C.** to display the setting mode.
- 2 Turn **M.C.** to change the mode; press to select.
 - **Artist** – Plays an album of the artist currently being played.
 - **Album** – Plays a song from the album currently being played.
 - **Genre** – Plays an album from the genre currently being played.

The selected song/album will be played after the currently playing song.

- This function is only available for external storage devices (USB, SD).

Pause (pause)

- 1 Press **M.C.** to pause or resume.

Sound Retriever (sound retriever)

Automatically enhances compressed audio and restores rich sound.

- 1 Press **M.C.** to select the desired setting.
 - OFF** (off)—**1—2**
 - 1** is effective for low compression rates, and **2** is effective for high compression rates.



Playing songs on an iPod

- 1 Connect an iPod to the USB cable using an iPod Dock Connector.

Selecting a track (chapter)

- 1 Turn **LEVER**.

Fast forwarding or reversing

- 1 Turn and hold down **LEVER** to the right or left.

Selecting an album

- 1 Press **▲** or **▼**.

Notes

- The iPod cannot be turned on or off when the control mode is set to **AUDIO**.
- Disconnect headphones from the iPod before connecting it to this unit.
- The iPod will turn off about two minutes after the ignition switch is set to OFF.

Displaying text information

Selecting the desired text information

- 1 Press **⇒/DISP**.

iPod

Basic operations

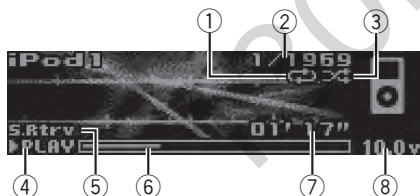

- ① Repeat indicator
- ② Song number indicator
- ③ Shuffle indicator
- ④ **PLAY/PAUSE** indicator
- ⑤ **S.Rtrv** indicator
Appears when Sound Retriever function is on.
- ⑥ Song time (progress bar)
- ⑦ Play time indicator
- ⑧ Voltage indicator
Shows the battery voltage.
 - The level displayed on the voltage indicator may differ from the actual voltage level.

Browsing for a song

1 Press **Q** (list) to switch to the top menu of the list search.

2 Use **M.C.** to select a category/song.

Changing the name of the song or category

- 1 Turn **M.C.**
 - Playlists** (playlists)—**Artists** (artists)—**Albums** (albums)—**Songs** (songs)—**Podcasts** (podcasts)—**Genres** (genres)—**Composers** (composers)—**Audiobooks** (audiobooks)
 - You can also perform this operation by turning **LEVER**.

Playing

- 1 When a song is selected, press **M.C.**

Viewing a list of songs in the selected category

- 1 When a category is selected, press **M.C.**

Operating this unit

Playing a song in the selected category

- 1 When a category is selected, press and hold **M.C.**

Searching the list by alphabet

- 1 When a list for the selected category is displayed, press **Q** to switch to alphabet search mode.
- 2 Turn **M.C.** to select a letter.
- 3 Press **M.C.** to display the alphabetical list.

Notes

- You can play playlists created with the PC application (MusicSphere). The application will be available on our website.
- Playlists that you created with the PC application (MusicSphere) are displayed in abbreviated form.

Playing songs related to the currently playing song

You can play songs from the following lists.

- Album list of the currently playing artist
- Song list of the currently playing album
- Album list of the currently playing genre

1 Press and hold **M.C.** to switch to link play mode.

2 Turn **M.C.** to change the mode; press to select.

- **Artist** – Plays an album of the artist currently being played.
- **Album** – Plays a song from the album currently being played.
- **Genre** – Plays an album from the genre currently being played.

The selected song/album will be played after the currently playing song.

Notes

- The selected song/album may be canceled if you operate functions other than link search (e.g. fast forward and reverse).
- Depending on the song selected to play, the end of the currently playing song and the beginning of the selected song/album may be cut off.

Operating this unit's iPod function from your iPod

You can listen to the sound from your iPod applications using your car's speakers, when **APP** is selected.

This function is not compatible with the following iPod models.

- iPod with video
- iPod nano 1st generation

APP Mode is compatible with the following iPod models.

- iPod touch 4th generation (software version 4.1 or later)
- iPod touch 3rd generation (software version 3.0 or later)
- iPod touch 2nd generation (software version 3.0 or later)
- iPod touch 1st generation (software version 3.0 or later)
- iPhone 4 (software version 4.1 or later)
- iPhone 3GS (software version 3.0 or later)
- iPhone 3G (software version 3.0 or later)
- iPhone (software version 3.0 or later)

- 1 Press **BAND/** to switch the control mode.
 - **iPod** – This unit's iPod function can be operated from the connected iPod.
 - **APP** – Play back the sound from your iPod applications.
 - **AUDIO** – This unit's iPod function can be operated from this unit.

Function settings

1 Press **M.C.** to display the main menu.

2 Turn **M.C.** to change the menu option and press to select **FUNCTION**.

3 Turn **M.C.** to select the function.

After selecting, perform the following procedures to set the function.

Play mode (repeat play)

- 1 Press **M.C.** to select a repeat play range.
 - **Repeat One** – Repeat the current song
 - **Repeat All** – Repeat all songs in the selected list

Shuffle mode (shuffle)

Operating this unit

- 1 Press **M.C.** to select your favorite setting.
 - **Shuffle Songs** – Play back songs in the selected list in random order.
 - **Shuffle Albums** – Play back songs from a randomly selected album in order.
 - **Shuffle OFF** – Cancel random play.

Shuffle all (shuffle all)

- 1 Press **M.C.** to turn shuffle all on.
To turn off, set **Shuffle mode** in the **FUNCTION** menu to off.

Link play (link play)

- 1 Press **M.C.** to display the setting mode.
- 2 Turn **M.C.** to change the mode; press to select.
For details about the settings, refer to *Playing songs related to the currently playing song* on the previous page.

Pause (pause)

- 1 Press **M.C.** to pause or resume.

Tags transfer (Tags transfer)

Transfer the tag information contained in the tuner source.

- 1 Press **M.C.** to store the tag information. Refer to *Using iTunes tagging* on page 11.

Audiobooks (audiobook speed)

- 1 Press **M.C.** to select your favorite setting.
 - **Faster** – Playback at a speed faster than normal
 - **Normal** – Playback at normal speed
 - **Slower** – Playback at a speed slower than normal

Sound Retriever (sound retriever)

- 1 Press **M.C.** to select the desired setting.
OFF (off)—**1**—**2**
1 is effective for low compression rates, and **2** is effective for high compression rates.

Notes

- Switching the control mode to **iPod** pauses song playback. Operate the iPod to resume playback.
- The following functions are still accessible from the unit even if the control mode is set to **iPod/APP**.
 - Pausing
 - Fast forward/reverse

— Track up/down

- When the control mode is set to **iPod/APP**, only **Pause**, **Tags transfer** or **Sound Retriever** is available.
- The browse function cannot be operated from this unit.

Using Pandora®

IMPORTANT:

Requirements to access the Pandora music service using the Pioneer car audio/video products:

- Apple iPhone (first generation), iPhone 3G, iPhone 3GS, iPhone 4G, iPod touch 1G, iPod touch 2G, iPod touch 3G or iPod touch 4G (firmware version 3.0 or later).

Certain firmware versions for the iPod touch and iPhone may not be compatible with the Pandora application. If this appears to be the case, please update the firmware to a version that is compatible with Pandora.

- Latest version of the Pandora application for the iPhone, downloaded to your device. (Search Apple iTunes App Store for "Pandora").
- Current Pandora account (Free account and paid accounts available from Pandora; create a free account online at <http://www.pandora.com/register> or through the Pandora application for the iPhone).
- iPhone Data Plan.

Note: If the Data Plan for your iPhone does not provide for unlimited data usage, *additional charges from your carrier may apply* for accessing the Pandora service via 3G and/or EDGE networks.

- Connection to the Internet via 3G, EDGE or Wi-Fi network.
- Optional Pioneer adapter cable connecting your iPhone to the Pioneer car audio/video products.

Limitations:

- Access to the Pandora service will depend on the availability of a cellular and/or Wi-Fi network for purposes of allowing your iPhone to connect to the Internet.

Operating this unit

- Ability of the Pioneer car audio/video products to access the Pandora service is subject to change without notice and could be affected by any of the following: compatibility issues with future firmware versions of iPhones; compatibility issues with future firmware versions of the Pandora application for the iPhone; changes to the Pandora music service by Pandora; discontinuation of the Pandora music service by Pandora.
- Certain functionality of the Pandora service is not available when accessing the service through the Pioneer car audio/video products, including, but not limited to, creating new stations, deleting stations, emailing current stations, buying tracks from iTunes, viewing additional text information, logging in to Pandora, and adjusting Cell Network Audio Quality.

Pandora Internet radio is a music service not affiliated with Pioneer. More information is available at <http://www.pandora.com>.

You can play the Pandora by connecting your iPod which was installed the Pandora application.

Notes

- Two iPods can be connected to this unit at the same time. Settings are the same as those for **Pandora1** and **Pandora2**.
- If there are two iPods connected to this unit, the iPod connected to the input of the selected source is the one that is operated.
- Disconnect communications for the selected iPod before switching to operation of the other iPod.

Basic operations



- ① Thumbs Up/Thumbs Down indicator

- ② QuickMix indicator
 ③ **PLAY/PAUSE** indicator
 ④ **S.Rtrv** indicator
 Appears when Sound Retriever function is on.
 ⑤ Song time (progress bar)
 ⑥ Play time indicator
 ⑦ Voltage indicator
 Shows the battery voltage.
- The level displayed on the voltage indicator may differ from the actual voltage level.

Playing tracks

- ① Connect an iPod to the USB cable using an iPod Dock Connector.
 ② Start up the Pandora application installed on the iPod.

Giving a Thumbs Up

- ① Press **▲** to give a "Thumbs Up" for the track currently playing.

Giving a Thumbs Down

- ① Press **▼** to give a "Thumbs Down" for the track currently playing and to skip to the next track.

Skipping tracks

- ① Turn **LEVER** to the right.

Displaying text information

Selecting the desired text information

- ① Press **➡/DISP**.

Selecting and playing the QuickMix/station list

- 1 Press **🔍 (list)** to switch to the QuickMix/station list mode.

Operating this unit

2 Use M.C. to select the QuickMix or desired station.

Changing the sort order

① Press **Q** (list).

- **ABC** – You can sort the items in the list alphabetically
- **DATE** – You can sort the items in the list in order of the dates on which the items were created

Changing QuickMix or stations

① Turn **M.C.**

Playing

① When QuickMix or the station is selected, press **M.C.**

Function settings

1 Press M.C. to display the main menu.

2 Turn M.C. to change the menu option and press to select FUNCTION.

3 Turn M.C. to select the function.

After selecting, perform the following procedures to set the function.

Bookmark (bookmark)

① Press **M.C.** to store track information.

Pause (pause)

① Press **M.C.** to pause or resume.

Sound Retriever (sound retriever)

① Press **M.C.** to select the desired setting.
1—2—OFF (off)
1 is effective for low compression rates, and **2** is effective for high compression rates.



Audio adjustments

Operation modes

This unit features two operation modes: the 3-way network mode (NW) and the standard mode (STD). You can switch between modes as desired. Initially, the DSP setting is set to the standard mode (STD). (Refer to *Switching the DSP setting mode* on page 5.)

- The 3-way network mode (NW) lets you create a 3-way multi-amp, multi-speaker system with separate speakers for reproduction of high, middle and low frequencies (bands), each driven by a dedicated power amp. The 3-way network mode provides network and time alignment functions, two functions essential for a multi-amp, multi-speaker system, to enable precise control over settings for each frequency range.
- The standard mode (STD) lets you create a 4-speaker system with front and rear speakers, or a 6-speaker system with front and rear speakers and subwoofers.

⚠ Important

This unit's audio settings will continue to remain in the memory even if the battery is disconnected or the microprocessor reset. If you want to reset the audio settings, refer to **AUDIO reset** (*audio reset*) on page 36.

Operation mode marks

This manual uses the following marks to make the description clear.

NW : This mark indicates a function only in 3-way network mode or an operation in 3-way network mode.

STD : This mark indicates a function available only in standard mode or an operation in standard mode.

- The functions and operations which do not carry either mark are commonly used in the 3-way network mode and standard mode.

3-way network mode

Adjusting the audio easily

By carrying out the following settings/adjustments in the order shown, you can effortlessly create a finely-tuned sound field.

- ① *Using the position selector* (**POSI**)
- ② *Auto TA and EQ (auto-time alignment and auto-equalizing)*
- ③ *Using balance adjustment* (**BAL**)
- ④ *Recalling equalizer curves*

Operating this unit

Adjusting the audio finely

By carrying out the following settings/adjustments in the order shown, you can effortlessly create a finely-tuned sound field.

- ① *Adjusting time alignment* (**TA1, TA2**)
- ② *Adjusting network* (**NW 1, NW 2, NW 3, NW 4**)
- ③ *Adjusting equalizer curves* (**EQ 1**)
- ④ *Adjusting the 16-band graphic equalizer* (**EQ 2**)

Standard mode

Adjusting the audio easily

The following functions let you easily adjust your audio system to match the car interior acoustic characteristics, which vary depending on the type of car.

- ① *Using the position selector* (**POSI**)
- ② *Auto TA and EQ (auto-time alignment and auto-equalizing)*
- ③ *Using fader/balance adjustment* (**F/B**)
- ④ *Recalling equalizer curves*

Adjusting the audio finely

By carrying out the following settings/adjustments in the order shown, you can effortlessly create a finely-tuned sound field.

- ① *Using time alignment* (**TA1, TA2**)
- ② *Using subwoofer output* (**SW 1**)
- ③ *Adjusting subwoofer settings* (**SW 2**)
- ④ *Adjusting low pass filter attenuation slope* (**SW 3**)
- ⑤ *Setting the high pass filter for front speakers* (**F.HPF 1, F.HPF 2**)
- ⑥ *Setting the high pass filter for rear speakers* (**R.HPF 1, R.HPF 2**)
- ⑦ *Adjusting equalizer curves* (**EQ 1**)
- ⑧ *Adjusting the 16-band graphic equalizer* (**EQ 2**)

Extra functions

These functions are helpful in adjusting the sound to suit your system or your personal preferences.

- *Adjusting loudness* (**LOUD**)
- *Adjusting source levels* (**SLA**)
- *Using automatic sound levelizer* (**ASL**)

Introduction of audio adjustments



①

① Audio display

1 Press M.C. to display the main menu.

2 Turn M.C. to change the menu option and press to select AUDIO.

3 Turn M.C. to select the audio function.

After selecting, perform the following procedures to set the audio function.

3-way network mode

BAL (balance adjustment)—**NW 1** (network adjustment 1)—**NW 2** (network adjustment 2)—**NW 3** (network adjustment 3)—**NW 4** (network adjustment 4)—**POSI** (position selector)—**TA1** (time alignment setting)—**TA2** (time alignment adjusting)—**LOUD** (loudness)—**EQ 1** (graphic equalizer)—**EQ 2** (16-band graphic equalizer)—**A.EQ** (auto-equalizer on/off)—**ASL** (automatic sound levelizer)—**SLA** (source level adjustment)

Standard mode

F/B (balance adjustment)—**POSI** (position selector)—**TA1** (time alignment setting)—**TA2** (time alignment adjusting)—**LOUD** (loudness)—**EQ 1** (graphic equalizer)—**EQ 2** (16-band graphic equalizer)—**SW 1** (subwoofer on/off)—**SW 2** (subwoofer cut-off frequency)—**SW 3** (subwoofer slope)—**F.HPF 1** (front high pass filter slope)—**F.HPF 2** (front high pass filter cut-off frequency)—**R.HPF 1** (rear high pass filter slope)—**R.HPF 2** (rear high pass filter cut-off frequency)—**A.EQ** (auto-equalizer on/off)—**ASL** (automatic sound levelizer)—**SLA** (source level adjustment)

Operating this unit

4 Press M.C. to display the setting mode.

- You can also switch between the audio functions in reverse order by turning **M.C.** counter-clockwise.
- When selecting FM as the source, you cannot switch to **SLA**.
- When selecting **OFF** in **TA1**, you cannot switch to **TA2**.
- You can select **SW 2** and **SW 3** only when subwoofer output is turned on in **SW 1**.
- To return to the display of each source, press **BAND/⏪**.

Notes

- If you do not operate the audio function within about 30 seconds, the display is automatically returned to the source display.
- EQ 2** (16-band graphic equalizer), **TA2** (time alignment adjusting), **NW 1** (network adjustment 1), **NW 2** (network adjustment 2), **NW 3** (network adjustment 3) and **NW 4** (network adjustment 4) functions are not canceled automatically.

Switching left and right channel

You can adjust following functions for left and right channel independently or commonly.

3-way network mode

- Adjusting network* (**NW 1**, **NW 2**, **NW 3**)
- Adjusting the 16-band graphic equalizer* (**EQ 2**)

Standard mode

- Adjusting subwoofer settings* (**SW 2**)
- Adjusting low pass filter attenuation slope* (**SW 3**)
- Setting the high pass filter for front speakers* (**F.HPF 1**, **F.HPF 2**)
- Setting the high pass filter for rear speakers* (**R.HPF 1**, **R.HPF 2**)
- Adjusting the 16-band graphic equalizer* (**EQ 2**)

1 Use M.C. to select the audio function described above.

2 Press M.C. and hold to switch between left/right common mode and left/right independent mode.

L/R (left/right common mode)—**Left** (left)—**Right** (right)

3 Adjust these functions as desired.

Using the position selector

One way to assure a more natural sound is to clearly position the stereo image, putting you right in the center of the sound field. The position selector function lets you automatically adjust the speakers' output levels and inserts a delay time to match the number and position of occupied seats.

1 Use M.C. to select POSI in the audio function menu.

Refer to *Introduction of audio adjustments* on the previous page.

2 Turn LEVER to select a listening position.

OFF (off)—**Front Left** (front seat left)—**Front Right** (front seat right)—**Front** (front seats)—**All** (all seats) **STD**

Using balance adjustment

You can select a balance setting that provides an ideal listening environment in all occupied seats.

- This function is only available in 3-way network mode **NW**.

1 Use M.C. to select BAL.

Refer to *Introduction of audio adjustments* on the previous page.

2 Turn LEVER to adjust the left/right speaker balance.

Left 25 to **Right 25** is displayed as the left/right speaker balance moves from left to right.

Using fader/balance adjustment

You can change the fader/balance setting to provide an ideal listening environment for all of the occupied seats.

- This function is only available in standard mode **STD**.

1 Use M.C. to select F/B.

Refer to *Introduction of audio adjustments* on page 20.

2 Turn LEVER to adjust the front/rear speaker balance.

Front 25 to **Rear 25** is displayed as the front/rear speaker balance moves from front to rear.

- Select **F/R 00** when only using two speakers.

3 Press M.C. to display the left/right speaker balance mode.

4 Turn LEVER to adjust the left/right speaker balance.

Left 25 to **Right 25** is displayed as the left/right speaker balance moves from left to right.

Using time alignment

The distance between the listening position and each speaker can be adjusted with this function.

1 Use M.C. to select TA1 in the audio function menu.

Refer to *Introduction of audio adjustments* on page 20.

2 Turn LEVER to select the time alignment.

Initial (initial)—**Custom** (custom)—**Auto TA** (auto-time alignment)—**OFF** (off)

- Initial** is the factory supplied time alignment.
- Custom** is an adjusted time alignment that you can create for yourself.
- Auto TA** is the time alignment created by auto TA and EQ. (Refer to *Auto TA and EQ (auto-time alignment and auto-equalizing)* on page 29.)

- You cannot select **Auto TA** if auto TA and EQ has not been carried out. In this case, **Please set Auto TA** appears.

Adjusting time alignment

The distance between the selected position and each speaker can be adjusted.

- An adjusted time alignment is memorized in **Custom**.

1 Use M.C. to select TA 1.

Refer to *Introduction of audio adjustments* on page 20.

2 Press M.C. to select a unit of distance. (cm) (centimeter)—(inch) (inch)

3 Press ⇨/DISP to display the upper tier.

4 Use M.C. to select TA2.

Refer to *Introduction of audio adjustments* on page 20.

- Can't Adjust TA. Set POS. FL/FR** appears when neither **Front Left** nor **Front Right** is selected in the position selector mode (**POSI**).
- When selecting **OFF** in **TA1**, you cannot switch to **TA2**.

5 Turn M.C. to select the speaker to be adjusted.

3-way network mode

High L (high-range left)—**High R** (high-range right)—**Mid L** (middle-range left)—**Mid R** (middle-range right)—**Low L** (low-range left)—**Low R** (low-range right)

Standard mode

Front L (front left)—**Front R** (front right)—**Rear R** (rear right)—**Rear L** (rear left)—**SubW. L** (subwoofer left)—**SubW. R** (subwoofer right)

- You cannot select **SubW. L** and **SubW. R** when the subwoofer output is off.

Operating this unit

6 Turn LEVER to adjust the distance between the selected speaker and the listening position.

400.0cm to 0.0cm is displayed as the distance is increased or decreased, if you have selected centimeters **((cm))**.

160inch to 0inch is displayed as the distance is increased or decreased, if you have selected inches **((inch))**.

- You can adjust the distance for the other speakers in the same way.

7 Press BAND/ to cancel the time alignment mode.

About the network function

The network function lets you divide the audio signal into different frequency bands, and then reproduce each of them through separate speaker units.

You can then make precise adjustments to the reproduced frequency band (with a low-pass filter or high-pass filter), level, phase and other parameters to match the characteristics of each speaker unit.

Adjustable parameters

The network function enables adjustment of the following parameters. Make adjustments in line with the reproduced frequency band and characteristics of each connected speaker unit.

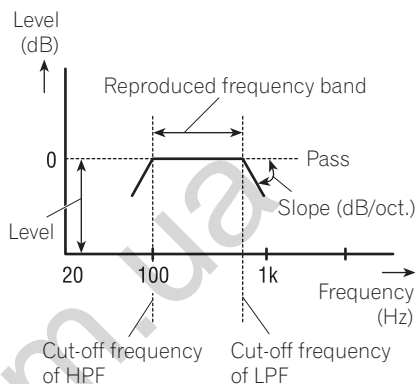

Reproduced frequency band

Adjusting the HPF (high-pass filter) or LPF (low-pass filter) cut-off frequency lets you set the reproduced frequency band for each speaker unit.

- The HPF cuts frequencies (low) below the set frequency, letting high frequencies through.
- The LPF cuts frequencies (high) above the set frequency, letting low frequencies through.

Level

The difference in reproduced levels between speaker units can be corrected.

Slope

Adjusting the HPF/LPF slope (filter attenuation slope) lets you adjust the continuity of sound between speaker units.

- The slope indicates the number of decibels (dB) the signal is attenuated when the frequency is one octave higher (lower) (Unit: dB/oct.). The steeper the slope, the more the signal is attenuated.

Phase

You can switch phase (normal, reverse) for each speaker unit's input signal. When the continuity of sound between speakers is imprecise, try switching phase. This may improve the continuity of sound between speakers.

Points concerning network adjustments

Cut-off frequency adjustment

- With the low-range speaker installed in the rear tray, if you set **Low LPF** cut-off frequency high, bass sound is separated so that it appears to come from the rear. You are recommended to set **Low LPF** cut-off frequency to 100 Hz or lower.
- The maximum input power setting for middle-range and high-range speakers is usually lower than low-range speakers. Please be aware that if the **Mid HPF** or **HighHPF** cut-off frequency is set lower than required, strong bass signal input may damage the speaker.

Level adjustment

The basic frequencies of many musical instruments are in the middle range. First perform middle-range level adjustment, followed by high-range and then low-range level adjustment in that order.

Slope adjustment

- If you set a small absolute value for the slope (for a gentle slope), interference between adjacent speaker units can easily result in degraded frequency response.
- If you set a large absolute value for the slope (for a steep slope), continuity of sound between speaker units is degraded, and sounds appear to be separated.
- If you set the slope to 0 dB/oct. (pass), the audio signal bypasses the filter, so the filter does not have an effect.

Phase adjustment

When the cross-over point value for filters on both sides is set to -12 dB/oct., the phase is reversed 180 degrees at the filter cut-off frequency. In this case, reversing the phase assures improved sound continuity.

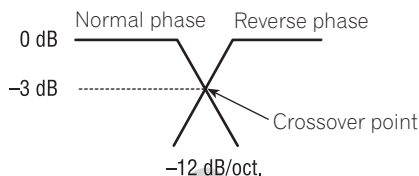

Muting the speaker unit (filter)

You can mute each speaker unit (filter). When a speaker unit (filter) is muted, no sound is outputted from that speaker.

- If you mute the selected speaker unit (filter), **MUTE** blinks and no adjustments are possible.
- Even if any speaker unit (filter) is muted, you can adjust the parameters for other speaker units (filters).

1 Use M.C. to select NW 1.

Refer to *Introduction of audio adjustments* on page 20.

2 Turn LEVER to select the speaker unit (filter) to be adjusted.

Low LPF (low-range speaker LPF)—**Mid HPF** (middle-range speaker HPF)—**Mid LPF** (middle-range speaker LPF)—**HighHPF** (high-range speaker HPF)

3 Press M.C. to mute the selected speaker unit (filter).

MUTE blinks in the display.

- To cancel the muting, press **M.C.** again.

Adjusting network

1 Use M.C. to select NW 1.

Refer to *Introduction of audio adjustments* on page 20.

Operating this unit

2 Turn LEVER to select the speaker unit (filter) to be adjusted.

Low LPF (low-range speaker LPF)—**Mid HPF** (middle-range speaker HPF)—**Mid LPF** (middle-range speaker LPF)—**HighHPF** (high-range speaker HPF)

3 Press \rightarrow /DISP to display the upper tier.

4 Use M.C. to select NW 2.

Refer to *Introduction of audio adjustments* on page 20.

5 Turn M.C. to select the cut-off frequency (crossover frequency) of the selected speaker unit (filter).

Low LPF: 25—31.5—40—50—63—80—100—125—160—200—250 (Hz)

Mid HPF: 25—31.5—40—50—63—80—100—125—160—200—250 (Hz)

Mid LPF: 1.25k—1.6k—2k—2.5k—3.15k—4k—5k—6.3k—8k—10k—12.5k (Hz)

HighHPF: 1.25k—1.6k—2k—2.5k—3.15k—4k—5k—6.3k—8k—10k—12.5k (Hz)

6 Turn LEVER to adjust the level of the selected speaker unit (filter).

±0dB to **-24dB** is displayed as the level is increased or decreased.

+6dB to **-24dB** is displayed as the level is increased or decreased, only if you have selected **Low LPF**.

7 Press \rightarrow /DISP to display the upper tier.

8 Use M.C. to select NW 3.

Refer to *Introduction of audio adjustments* on page 20.

9 Turn LEVER to select the slope of the selected speaker unit (filter).

Low LPF: -36—-30—-24—-18—-12 (dB/oct.)

Mid HPF: -24—-18—-12—-6—Pass (0) (dB/oct.)

Mid LPF: -24—-18—-12—-6—Pass (0) (dB/oct.)

HighHPF: -24—-18—-12—-6 (dB/oct.)

10 Press M.C. to switch the phase of the selected speaker unit (filter).

NOR (normal)—**REV** (reverse)

▪ You can adjust the parameters for other speaker units (filters) in the same way.

11 Press \rightarrow /DISP to display the upper tier.

12 Use M.C. to select NW 4.

Refer to *Introduction of audio adjustments* on page 20.

13 Press M.C. to select stereo or monaural.

Stereo (stereo)—**MONO** (monaural)

▪ You can operate this procedure only when **Low LPF** is selected.

14 Press BAND/ \leftarrow to cancel the network adjustment mode.

Using subwoofer output

This unit is equipped with a subwoofer output which can be turned on or off. When a subwoofer is connected to this unit, turn the subwoofer output on.

The subwoofer output phase can be switched between normal and reverse.

• This function is only available in standard mode **STD**.

1 Use M.C. to select SW 1.

Refer to *Introduction of audio adjustments* on page 20.

2 Press M.C. to turn subwoofer output on.

ON appears in the display. Subwoofer output is now on.

▪ To turn subwoofer output off, press **M.C.** again.

3 Turn LEVER to select stereo or monaural.

Stereo (stereo)—**MONO** (monaural)

Adjusting subwoofer settings

The cut-off frequency and output level can be adjusted when the subwoofer output is on.

1 Use M.C. to select SW 2.

Refer to *Introduction of audio adjustments* on page 20.

- When the subwoofer output is on, you can select **SW 2**.

2 Turn M.C. to select cut-off frequency. 50—63—80—100—125 (Hz)

Only frequencies lower than those in the selected range are outputted from the subwoofer.

3 Turn LEVER to adjust the output level of the subwoofer.

+6 to **-24** is displayed as the level is increased or decreased.

Adjusting low pass filter attenuation slope

When the subwoofer output is on, you can adjust the continuity of sound between speaker units.

1 Use M.C. to select SW 3.

Refer to *Introduction of audio adjustments* on page 20.

- When the subwoofer output is on, you can select **SW 3**.

2 Press M.C. to select the phase of subwoofer output.

NOR (normal)—**REV** (reverse)

3 Turn LEVER to select slope.

-18—**-12**—**-6** (dB/oct.)

Note

When slope of subwoofer and high pass filter are **-12dB**, and same cut-off frequency, the phase is reversed 180 degrees at the cut-off frequency. In this case, reversing the phase assures improved sound continuity.

Using the high pass filter

When you do not want low sounds from the subwoofer output frequency range to play from the front or rear speakers, turn on the HPF (high pass filter). Only frequencies higher than those in the selected range are output from the front or rear speakers.

- This function is only available in standard mode **STD**.

Muting the speaker units (filters)

You can mute front and rear speaker units (filters) separately. When speaker units (filters) are muted, no sound is outputted from those speakers.

- Even if the speaker unit (filter) is muted, you can adjust the muted speaker units (filters). However, mute is automatically canceled when the level is adjusted.

1 Use M.C. to select F.HPF 1 (or R.HPF 1).

Refer to *Introduction of audio adjustments* on page 20.

2 Press M.C. to mute the selected speaker unit (filter).

MUTE is displayed.

- To cancel the muting, press **M.C.** again.

Setting the high pass filter for front speakers

1 Use M.C. to select F.HPF 1.

Refer to *Introduction of audio adjustments* on page 20.

2 Turn LEVER to select slope.

-12—**-6**—**Pass** (dB/oct.)

- If you set the slope **Pass** (0 dB/oct.), the audio signal bypasses the filter, so the filter does not have an effect.

3 Press \rightarrow /DISP to display the upper tier.

4 Use M.C. to select F.HPF 2.

Refer to *Introduction of audio adjustments* on page 20.

Operating this unit

5 Turn M.C. to select cut-off frequency.

50—63—80—100—125—160—200 (Hz)

Only frequencies higher than those in the selected range are output from the front speakers.

6 Turn LEVER to adjust the output level of the front speakers.

0 to -24 is displayed as the level is increased or decreased.

Setting the high pass filter for rear speakers

1 Use M.C. to select R.HPF 1.

Refer to *Introduction of audio adjustments* on page 20.

2 Turn LEVER to select slope.

-12—-6—Pass (dB/oct.)

▪ If you set the slope **Pass** (0 dB/oct.), the audio signal bypasses the filter, so the filter does not have an effect.

3 Press \rightarrow /DISP to display the upper tier.

4 Use M.C. to select R.HPF 2.

Refer to *Introduction of audio adjustments* on page 20.

5 Turn M.C. to select cut-off frequency.

50—63—80—100—125—160—200 (Hz)

Only frequencies higher than those in the selected range are output from the rear speakers.

6 Turn LEVER to adjust the output level of the rear speakers.

+6 to -24 is displayed as the level is increased or decreased.

Using the auto-equalizer

The auto-equalizer is the equalizer curve created by auto TA and EQ (refer to *Auto TA and EQ (auto-time alignment and auto-equalizing)* on page 29).

You can turn the auto-equalizer on or off.

1 Use M.C. to select A.EQ in the audio function menu.

Refer to *Introduction of audio adjustments* on page 20.

▪ If auto TA and EQ has not been carried out, **Please set Auto EQ** appears. This indicates that you cannot turn this function on.

2 Press M.C. to turn the auto-equalizer on.

Auto EQ ON appears in the display.

▪ To turn auto-equalizer off, press **M.C.** again.

Recalling equalizer curves

You can adjust the equalization to match the car's interior acoustic characteristics as desired.

There are seven stored equalizer curves which you can easily recall at any time. Here is a list of the equalizer curves.

Display	Equalizer curve
Super bass	Super bass
Powerful	Powerful
Natural	Natural
Vocal	Vocal
Flat	Flat
Custom1	Custom 1
Custom2	Custom 2

- **Custom1** and **Custom2** are adjusted equalizer curves that you create. Adjustments can be made with a 16-band graphic equalizer.
- When **Flat**, no changes are made to the sound. You can check the effects of the equalizer curves by switching alternatively between **Flat** and another equalizer curve.

● Press EQ/DISP OFF to select the equalizer.

Press **EQ/DISP OFF** repeatedly to switch between the following equalizers:

Powerful—Natural—Vocal—Flat—Custom1—Custom2—Super bass

Adjusting equalizer curves

The factory supplied equalizer curves, with the exception of **Flat**, can be adjusted to a fine degree (nuance control).

1 Use M.C. to select EQ 1.

Refer to *Introduction of audio adjustments* on page 20.

2 Turn M.C. to select an equalizer curve.

3 Turn LEVER to adjust the equalizer curve.

+6 to -6 is displayed as the equalizer curve is increased or decreased.

- The actual range of the adjustments are different depending on which equalizer curve is selected.
- The equalizer curve with all frequencies set to 0 cannot be adjusted.

Adjusting the 16-band graphic equalizer

You can adjust the level of each band for the **Custom1** and **Custom2** equalizer curves.

- A separate **Custom1** curve can be created for each source. If you make adjustments when a curve other than **Custom2** is selected, the equalizer curve settings will be recorded in **Custom1**.
- A **Custom2** curve that is common for all sources can be created. If you make adjustments when the **Custom2** curve is selected, the **Custom2** curve will be updated.

1 Recall the equalizer curve you want to adjust.

Refer to *Recalling equalizer curves* on the previous page.

2 Use M.C. to select EQ 2.

Refer to *Introduction of audio adjustments* on page 20.

3 Turn M.C. to select the equalizer band to adjust.

20—31.5—50—80—125—200—315—500—800—1.25k—2k—3.15k—5k—8k—12.5k—20k (Hz)

4 Turn LEVER to adjust the level of the equalizer band.

+6 to -6 is displayed as the level is increased or decreased.

- You can then select another band and adjust the level.

5 Press BAND/⏏ to cancel the 16-band graphic equalizer adjustment.

Adjusting loudness

Loudness compensates for deficiencies in the low-frequency and high-frequency ranges at low volume.

1 Use M.C. to select LOUD in the audio function menu.

Refer to *Introduction of audio adjustments* on page 20.

2 Press M.C. to turn loudness on.

- To turn loudness off, press M.C. again.

Adjusting source levels

With SLA (source level adjustment), the volume levels of each source can be adjusted to prevent significant differences between sources.

- Settings are based on the FM volume level, which remains unchanged.

1 Compare the FM volume level with the level of the source you wish to adjust.

2 Use M.C. to select SLA in the audio function menu.

Refer to *Introduction of audio adjustments* on page 20.

Operating this unit

3 Turn LEVER to adjust the source volume.

+4 to **-4** is displayed as the source volume is increased or decreased.

Notes

- The AM volume level can also be adjusted with this function.
- The USB/SD volume level can also be adjusted with this function.

Using automatic sound levelizer

During driving, noise in the car changes according to the driving speed and road conditions. The automatic sound levelizer (**ASL**) monitors such varying noise and automatically increases the volume level, if this noise becomes greater. The sensitivity (variation of volume level to noise level) of ASL can be set to one of five levels.

1 Use M.C. to select ASL.

Refer to *Introduction of audio adjustments* on page 20.

2 Press M.C. to turn ASL on.

- To turn ASL off, press **M.C.** again.

3 Turn LEVER to select the desired ASL level.

Low (low)—**Mid-L** (mid-low)—**Mid** (mid)—**Mid-H** (mid-high)—**High** (high)

Auto TA and EQ (auto-time alignment and auto-equalizing)

Auto-time alignment automatically adjusts the time alignment according to the distance between the listening position and each speaker. The auto-equalizer automatically measures the car's interior acoustic characteristics, and then creates an auto-equalizer curve based on that information.



WARNING

As a loud tone (noise) may be emitted from the speakers when measuring the car's interior

acoustic characteristics, never perform auto TA or auto EQ while driving.



CAUTION

- Thoroughly check the conditions before performing auto TA and EQ as the speakers may be damaged if these functions are performed when:
 - The speakers are incorrectly connected. (For example, when a rear speaker is connected as a subwoofer output.)
 - A speaker is connected to a power amp delivering output higher than the speaker's maximum input power capability.
- If the microphone is placed in an unsuitable position the measurement tone may become loud and measurement may take a long time, resulting in battery drainage. Be sure to place the microphone in the specified location.

Before operating the auto TA and EQ function

- Perform auto TA and EQ in a quiet place, with both the car engine and air conditioning switched off. Also turn off any car phones or portable telephones in the car, or remove them from the car. Sounds other than the measurement tone (such as surrounding sounds, engine sound, telephones ringing) may prevent correct measurement of the car's interior acoustic characteristics.
- Be sure to perform auto TA and EQ using the supplied microphone. Using another microphone may prevent measurement, or result in incorrect measurement of the car's interior acoustic characteristics.
- In order to perform auto TA and EQ, the front speaker must be connected.
- When muting the front speaker units, auto TA and EQ cannot be carried out. (Refer to page 26.)
- When this unit is connected to a power amp with input level control, auto TA and EQ may not be possible if the power amp's input level is set below the standard level.

- When this unit is connected to a power amp with an LPF, turn this LPF off before performing auto TA and EQ. Also set the cut-off frequency for the built-in LPF of an active subwoofer to the highest frequency.
- The time alignment value resulting from auto TA and EQ has been calculated by a computer and is the optimum delay time that will give accurate results. Be sure to use the resulting value although it may differ from the actual distance when:
 - The reflected sound within the car is strong and delays occur.
 - The LPF on active subwoofers or external amps delay the lower sounds.
- Auto TA and EQ changes the audio settings as follows:
 - The fader/balance settings return to the center position. (Refer to *Using fader/balance adjustment* on page 22.)
 - The graphic equalizer curve switches to **Flat**. (Refer to page 27.)
 - When a subwoofer is connected to this unit, it will be adjusted automatically to both subwoofer output and high pass filter setting for rear speaker.
- Previous settings for auto TA and EQ will be overwritten.
- When connecting tweeters, please confirm the tweeter's usable frequency range. When you set the cut-off frequency, set higher than the lowest usable frequency of the tweeter.
- Auto TA uses higher range than 10 kHz for measurement. Therefore, using the tweeter that cannot reproduce 10 kHz frequency range may damage the tweeter. When auto TA and EQ is operated, be sure to set the appropriate cut-off frequency. Also, use the tweeter that can reproduce 10 kHz at the lowest usable frequency.

Performing auto TA and EQ

1 Stop the car in a place that is quiet, close all the doors, windows and sun roof, and then turn the engine off.

- If the engine is left running, the noise from the engine may cause incorrect auto TA and EQ.

2 Fix the supplied microphone in the center of the headrest of the driver's seat, facing forward.

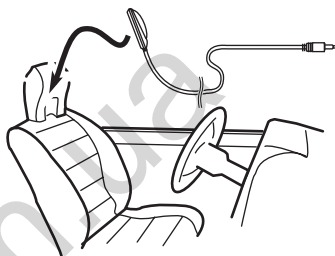

- The auto TA and EQ may differ depending on where you place the microphone. If desired, place the microphone on the front passenger seat to perform auto TA and EQ.

3 Turn the ignition switch to ON or ACC.

- If the air conditioner or heater is turned on, turn it off. The noise from the fan may cause incorrect auto TA and EQ.
- Press **SRC/OFF** to turn the source on if this unit is turned off.

4 Select the position for the seat on which the microphone is placed.

Refer to *Using the position selector* on page 21.

- If no position is selected before auto TA and EQ is started, **Front Left** is automatically selected.

5 Press SRC/OFF and hold until the unit turns off.

6 Press and hold EQ/DISP OFF to enter the auto TA and EQ measurement mode.

The front panel opens automatically.

Operating this unit

- 7 Plug the microphone into the microphone input jack on this unit.**

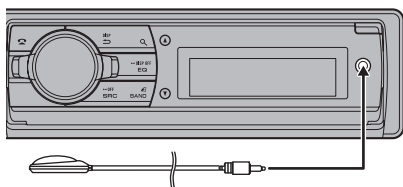

- 8 Press M.C. to start the auto TA and EQ.**

- 9 When the 10-second countdown starts, get out of the car and close the door within 10 seconds.**

The measurement tone (noise) is outputted from the speakers, and auto TA and EQ begins.

- When all speakers are connected, auto TA and EQ is completed in about six minutes.
- To stop auto TA and EQ, press **M.C.** again.
- To cancel auto TA and EQ part way through, press **BAND/** .

- 10 When auto TA and EQ is completed, Complete is displayed.**

When correct measurement of car interior acoustic characteristics is not possible, an error message is displayed. (Refer to *Auto TA and EQ* on page 43.)

- 11 Press BAND/** **to cancel the auto TA and EQ mode.**

- 12 Store the microphone carefully in the glove compartment or another safe place.**

If the microphone is subjected to direct sunlight for an extended period, high temperatures may cause distortion, color change or malfunction.

Using Bluetooth wireless technology

Using Bluetooth telephone

Important

- Since this unit is on standby to connect with your cellular phone via Bluetooth wireless technology, using it without the engine running can drain the battery power.
- Operations may vary depending on the kind of cellular phone.
- Advanced operations that require attention such as dialing numbers on the monitor, using the phone book, etc., are prohibited while driving. Park your vehicle in a safe place when using these advanced operations.

Setting up for hands-free phoning

Before you can use the hands-free phoning function you must set up the unit for use with your cellular phone.

- | | |
|---|--|
| 1 | Connection
Operate the Bluetooth telephone connection menu. Refer to <i>Connection menu operation</i> on the next page. |
| 2 | Function settings
Operate the Bluetooth telephone function menu. Refer to <i>Phone menu operation</i> on page 34. |

Basic operations

- | | |
|-----------------------------------|--|
| Making a phone call | <ul style="list-style-type: none"> • Refer to <i>Phone menu operation</i> on page 34. |
| Answering an incoming call | 1 When a call is received, press M.C. |
| Ending a call | 1 Press . |
| Rejecting an incoming call | 1 When a call is received, press . |
| Answering a call waiting | 1 When a call is received, press M.C. |
| Switching between callers on hold | 1 Press M.C. |

Operating this unit

Canceling call waiting

① Press .

Adjusting the other party's listening volume

① Turn **LEVER** while talking on the phone.

- When private mode is on, this function is not available.

Turning private mode on or off

① Press **BAND**/ while talking on the phone.

Switching the information display

① Press /**DISP** while talking on the phone.

Notes

- If private mode is selected on the cellular phone, hands-free phoning may not be available.
- The estimated call time appears in the display (this may differ slightly from the actual call time).

Connection menu operation

Important

- Be sure to park your vehicle in a safe place and apply the parking brake when performing this operation.
- Connected devices may not operate properly if more than one Bluetooth device is connected at a time (e.g. a phone and a separate audio player are connected simultaneously).

1 Press and hold to display the connection menu.

- You cannot operate this step during a call.

2 Turn **M.C.** to select the function.

After selecting, perform the following procedures to set the function.

Device list (connecting or disconnecting a device from the device list)

- When no device is selected in the device list, this function is not available.
- ① Press **M.C.** to display the setting mode.
 - ② Turn **M.C.** to select the name of a device you want to connect/disconnect.
 - Press and hold **M.C.** to switch the Bluetooth device address and device name.
 - ③ Press **M.C.** to connect/disconnect the selected device.

Once the connection is established, **Connected** is displayed.

Delete device (deleting a device from the device list)

- When no device is selected in the device list, this function is not available.
- ① Press **M.C.** to display the setting mode.
 - ② Turn **M.C.** to select the name of a device you want to delete.
 - Press and hold **M.C.** to switch the Bluetooth device address and device name.
 - ③ Press **M.C.** to display **Delete YES**.
 - ④ Press **M.C.** to delete a device information from the device list.
 - While this function is in use, do not turn off the engine.

Add device (connecting a new device)

- ① Press **M.C.** to start searching.
 - To cancel, press **M.C.** while searching.
 - If this unit fails to find any available cellular phones, **Not found** is displayed.
- ② Turn **M.C.** to select a device from the device list.
 - Press and hold **M.C.** to switch the Bluetooth device address and device name.
- ③ Press **M.C.** to connect the selected device.
 - To complete the connection, check the device name (**Pioneer BT Unit**). Enter the PIN code on your device if necessary.
 - PIN code is set to **0000** as the default. You can change this code.
 - 6-digit number appears on the display of this unit. Once the connection is established, this number disappears.
 - If you are unable to complete the connection using this unit, use the device to connect to the unit.
 - If three devices are already paired, **Device Full** is displayed and it is not possible to perform this operation. In this case, delete a paired device first.

Operating this unit

Special device (setting a special device)

Bluetooth devices that are difficult to establish a connection with are called special devices. If your Bluetooth device is listed as a special device, select the appropriate one.

- 1 Press **M.C.** to display the setting mode.
 - If three devices are already paired, **Device Full** is displayed and it is not possible to perform this operation. In this case, delete a paired device first.
- 2 Turn **M.C.** to display a special device. Press to select.
- 3 Turn **M.C.** to display this unit's device name, Bluetooth device address and PIN code.
- 4 Use a device to connect to this unit.
 - To complete the connection, check the device name (**Pioneer BT Unit**) and enter the PIN code on your device.
 - PIN code is set to **0000** as the default. You can change this code.

Auto connect (connecting to a Bluetooth device automatically)

- 1 Press **M.C.** to turn automatic connection on or off.

Visibility (setting the visibility of this unit)

To check the availability of this unit from other devices, Bluetooth visibility of this unit can be turned on.

- 1 Press **M.C.** to turn the visibility of this unit on or off.
 - While setting **Special device**, Bluetooth visibility of this unit is turned on temporarily.

Pin code input (PIN code input)

To connect your device to this unit via Bluetooth wireless technology, you need to enter a PIN code on your device to verify the connection. The default code is **0000**, but you can change it with this function.

- 1 Press **M.C.** to display the setting mode.
- 2 Turn **M.C.** to select a number.
- 3 Press **M.C.** to move the cursor to the next position.
- 4 After inputting PIN code, press and hold **M.C.**
 - After inputting, pressing **M.C.** returns you to the PIN code input display, and you can change the PIN code.

Device INFO (Bluetooth device address display)

- 1 Press **M.C.** to display the setting mode.
- 2 Turn **M.C.** left to switch to the Bluetooth device address.
 - Turning **M.C.** right returns to the device name.

Bluetooth Audio

Important

- Depending on the Bluetooth audio player connected to this unit, the available operations will be limited to the following two levels:
 - A2DP profile (Advanced Audio Distribution Profile): You can only playback songs on your audio player.
 - AVRCP profile (Audio/Video Remote Control Profile): You can perform playback, pause playback, select songs, etc.
- Since there are a number of Bluetooth audio players available on the market, available operations will vary extensively. When operating your player with this unit, refer to the instruction manual that came with your Bluetooth audio player as well as this manual.
- Information related to a song (such as the elapsed playing time, song title, song index, etc.) cannot be displayed on this unit.
- As the signal from your cellular phone may cause noise, avoid using it when you are listening to songs on your Bluetooth audio player.
- When a call is in progress on the cellular phone connected to this unit via Bluetooth wireless technology, the sound of the Bluetooth audio player connected to this unit is muted.
- When the Bluetooth audio player is in use, you cannot connect to a Bluetooth telephone automatically.
- Playback continues even if you switch from your Bluetooth audio player to another source while listening to a song.

Setting up for Bluetooth audio

Before you can use the Bluetooth audio function you must set up the unit for use with your Bluetooth audio player. This entails establishing a Bluetooth wireless connection between this unit and your Bluetooth audio player, and pairing your Bluetooth audio player with this unit.

Basic operations



- ① Device name
Shows the device name of the connected Bluetooth audio player.
- ② Voltage indicator
Shows the battery voltage.
 - The level displayed on the voltage indicator may differ from the actual voltage level.

Fast forwarding or reversing

- ① Turn and hold down **LEVER** to the right or left.

Selecting a track

- ① Turn **LEVER**.

Starting playback

- ① Press **BAND/**.

Play (play)

- ① Press **M.C.** to start playback.

Stop (stop)

- ① Press **M.C.** to stop the playback.

Pause (pause)

- ① Press **M.C.** to turn pause on.

Phone menu operation

Important

Be sure to park your vehicle in a safe place and apply the parking brake when performing this operation.

1 Press to display the phone menu.

2 Turn M.C. to select the function.

After selecting, perform the following procedures to set the function.

Missed calls (missed call history)

Dialed calls (dialed call history)

Received calls (received call history)

- ① Press **M.C.** to display the phone number list.
- ② Turn **M.C.** to select a name or phone number.
- ③ Press **M.C.** to make a call.
 - To display details about the contact you selected, press and hold **M.C.**

PhoneBook (phone book)

Function settings

1 Press M.C. to display the main menu.

2 Turn M.C. to change the menu option and press to select FUNCTION.

3 Turn M.C. to select the function.

After selecting, perform the following procedures to set the function.

Operating this unit

- The phone book in your cellular phone will be transferred automatically when the phone is connected to this unit.
 - Depending on the cellular phone, the phone book may not be transferred automatically. In this case, operate your cellular phone to transfer the phone book. The visibility of this unit should be on. Refer to **Visibility** (*setting the visibility of this unit*) on page 33.
- 1 Press **M.C.** to display **SEARCH** (alphabetical list).
 - 2 Turn **M.C.** to select the first letter of the name you are looking for.
 - Press and hold **M.C.** to select the desired character type.
 - 3 Press **M.C.** to display a registered name list.
 - 4 Turn **M.C.** to select the name you are looking for.
 - 5 Press **M.C.** to display the phone number list.
 - 6 Turn **M.C.** to select a phone number you want to call.
 - 7 Press **M.C.** to make a call.

Phone Function (phone function)

You can set **Auto answer**, **Ring tone** and **PH.B. Name view** from this menu. For details, refer to *Function and operation* on this page.

Function and operation

1 Display Phone Function.

Refer to **Phone Function** (*phone function*) on this page.

2 Press M.C. to display the function menu.

3 Turn M.C. to select the function.

After selecting, perform the following procedures to set the function.

Auto answer (automatic answering)

- 1 Press **M.C.** to turn automatic answering on or off.

Ring tone (ring tone select)

- 1 Press **M.C.** to turn the ring tone on or off.

PH.B.Name view (phone book name view)

- 1 Press **M.C.** to switch between the lists of names.



Initial settings



- 1 Function display

- Shows the function status.

1 Press and hold SRC/OFF until the unit turns off.

2 Press M.C. and hold until the initial setting menu appears in the display.

3 Turn M.C. to select the initial setting.

After selecting, perform the following procedures to set the initial setting.

Language select (multi-language)

For your convenience, this unit equips multiple language display. You can select the language best suited to your first language.

- 1 Press **M.C.** to select the language.

English—Français—Español

Calendar (setting the date)

- 1 Press **M.C.** to select the segment of the calendar display you wish to set.
Year—Day—Month
- 2 Turn **M.C.** to set the date.

Clock (setting the clock)

- 1 Press **M.C.** to select the segment of the clock display you wish to set.
Hour—Minute
- 2 Turn **M.C.** to adjust the clock.

EngineTime alert (elapsed time display setting)

This setting allows you to measure the length of time that elapses from when the machine is turned on and display the amount of elapsed time per set period. Also, you will hear alarm.

- 1 Press **M.C.** to select your favorite setting.

OFF—15Minutes—30Minutes

Music browse (music browse)

Operating this unit

When operating external storage devices (USB, SD), you can select files from the list.

- 1 Press **M.C.** to select the setting.

OFF—USB memory1—USB memory2—SD card

Warning tone (warning tone setting)

If the front panel is not detached from the head unit within four seconds of turning off the ignition, a warning tone sounds. You can turn off the warning tone.

- 1 Press **M.C.** to turn the warning tone on or off.

AUX1 (front AUX input setting)/AUX2 (rear RCA input setting)

Activate this setting when using an auxiliary device connected to this unit.

- 1 Press **M.C.** to turn auxiliary setting on or off.

Dimmer (dimmer setting)

To prevent the display from being too bright at night, the display is automatically dimmed when the car's headlights are turned on. You can turn the dimmer on or off.

- 1 Press **M.C.** to turn dimmer on or off.

Contrast (display contrast setting)

- 1 Press **M.C.** to select the setting mode.
- 2 Turn **M.C.** to adjust the contrast level.
0 to 15 is displayed as the level is increased or decreased.

Digital ATT (digital attenuator)

When listening to a CD or other source on which the recording level is high, setting the equalizer curve level to high may result in distortion. You can switch the digital attenuator to low to reduce distortion.

- Sound quality is better at the high setting so this setting is usually used.

- 1 Press **M.C.** to select the setting.

HIGH (high)—**LOW** (low)

AUDIO reset (audio reset)

You can reset all audio functions.

- 1 Press **M.C.**
Does it RESET? appears in the display.

- 2 Press **M.C.**

- 3 Turn **M.C.** to select desired setting.

Are You Sure? appears in the display.

- 4 Press **M.C.**

Complete appears in the display and audio functions are reset.

- To cancel this function on the way, press **BAND/⏪**.

Internal AMP (power amp setting)

This unit features high power amplifier. However, in particular system, external amplifiers are used instead of internal amplifier. If you use external amplifiers in order to establish a multi-amp system, and don't use internal amplifier, it is recommended to turn off the internal amplifier. Turning off internal amplifier reduces the noise that comes from the behavior of internal amplifier.

- 1 Press **M.C.** to turn the internal power amplifier on or off.

Demonstration (demo display setting)

- 1 Press **M.C.** to turn the demo display on or off.

Ever-scroll (scroll mode setting)

When ever scroll is set to **ON**, recorded text information scrolls continuously in the display. Set to **OFF** if you prefer the information to scroll just once.

- 1 Press **M.C.** to turn the ever scroll on or off.

BT AUDIO (Bluetooth audio activation)

You need to activate the **BT Audio** source in order to use a Bluetooth audio player.

- 1 Press **M.C.** to turn the **BT Audio** source on or off.

Clear memory (resetting the Bluetooth wireless technology module)

Bluetooth device data can be deleted. To protect personal information, we recommend deleting this data before transferring the unit to other persons. The following settings will be deleted.

- phone book entries on the Bluetooth telephone
- preset numbers on the Bluetooth telephone
- registration assignment of the Bluetooth telephone
- call history of the Bluetooth telephone
- information of the connected Bluetooth telephone
- PIN code of the Bluetooth device

- 1 Press **M.C.** to show the confirmation display.

YES is displayed. Clearing memory is now on standby.

If you do not want to reset phone memory, turn **M.C.** to display **CANCEL** and press to select.

- 2 Press **M.C.** to clear the memory.

Cleared is displayed and the settings are deleted.

- While this function is in use, do not turn off the engine.

BT Version info. (Bluetooth version display)

You can display the system versions of this unit and of Bluetooth module.

Operating this unit

Software (updating the bluetooth software)

This function is used to update this unit with the latest bluetooth software. For about bluetooth software and updating, refer to our website.

- Never turn the unit off while the bluetooth software is being updated.
- Press **M.C.** to display the data transfer mode. Follow the on-screen instructions to finish updating the bluetooth software.



Other functions

Using AUX1 and AUX2 source

About AUX1 and AUX2

There are two methods to connect auxiliary devices to this unit.

AUX1 source

When connecting auxiliary device using the front AUX input.

- You need to activate the AUX setting in the initial setting menu. Refer to **AUX1** (front AUX input setting)/**AUX2** (rear RCA input setting) on the previous page.

1 Insert the mini plug into the AUX input jack on this unit.

For more details, refer to *Head unit* on page 7.

This auxiliary device is automatically set to **AUX1**.

2 Press SRC/OFF to select AUX1 as the source.

AUX2 source

When connecting auxiliary device using the rear RCA input.

- You need to activate the AUX setting in the initial setting menu. Refer to **AUX1** (front AUX input setting)/**AUX2** (rear RCA input setting) on the previous page.

1 Use the rear RCA input to connect an auxiliary device.

For more details, refer to the installation manual.

This auxiliary device is automatically set to **AUX2**.

2 Press SRC/OFF to select AUX2 as the source.

Using different entertainment displays

You can enjoy entertainment displays while listening to each sound source.

Important

ENTERTAINMENT will not display if the temperature is detected as being below 10°C. If this occurs, please wait for the unit to warm up before proceeding.

Switching the display indication

1 Press M.C. to display the main menu.

2 Turn M.C. to change the menu option and press to select ENTERTAINMENT.

3 Turn M.C. to select the function.

4 Press M.C. to display the Background.

5 Turn M.C. to change the display.

Background visual—genre—background picture 1—background picture 2—background picture 3—background picture 4—spectrum analyzer1—spectrum analyzer2—level indicator—level meter—simple display—movie screen —calendar

- Genre display changes depending on the genre of music.
- Genre display may not operate correctly depending on the application used to encode audio files.

Turning the clock display on or off

1 Press M.C. to display the main menu.

Operating this unit

2 Turn M.C. to change the menu option and press to select ENTERTAINMENT.

3 Turn M.C. to select the function.

Select the clock setting.

4 Press M.C. to select the desired setting.

Clock display—elapsed time display—clock off

Selecting the illumination color

This unit is equipped with multiple-color illumination. You can select desired colors for the keys and display of this unit. You also can customize the colors you want to use.

Selecting the key color from the illumination color list

You can select desired colors for the keys of this unit.

1 Press M.C. to display the main menu.

2 Turn M.C. to change the menu option and press to select ILLUMI.

3 Turn M.C. to display Key and press to select.

4 Turn M.C. to select the illumination color.

You can select one option from the following list.

- **27** preset colors (**WHITE** to **ROSE**)
- **SCAN** (cycle through all colors)
- Three sets of colors (**WARM**, **AMBIENT**, **CALM**)
- **CUSTOM** (customized illumination color)

Notes

- When **SCAN** is selected, the system automatically cycles through the **27** preset colors.
- When **WARM** is selected, the system automatically cycles through the warm colors.
- When **AMBIENT** is selected, the system automatically cycles through the ambient colors.

- When **CALM** is selected, the system automatically cycles through the calm colors.
- When **CUSTOM** is selected, the customized color saved is selected.

Selecting the display color from the illumination color list

You can select the desired colors for the display of this unit.

1 Press M.C. to display the main menu.

2 Turn M.C. to change the menu option and press to select ILLUMI.

3 Turn M.C. to switch to Display and press to select.

4 Turn M.C. to select the illumination color.

You can select one option from the following list.

- **27** preset colors (**WHITE** to **ROSE**)
- **SCAN** (cycle through all colors)
- Three sets of colors (**WARM**, **AMBIENT**, **CALM**)
- **CUSTOM** (customized illumination color)

Note

For details about colors on the list, refer to *Selecting the key color from the illumination color list* on this page.

Selecting key and display color from the illumination color list

You can select the desired colors for the keys and display of this unit.

1 Press M.C. to display the main menu.

2 Turn M.C. to change the menu option and press to select ILLUMI.

3 Turn M.C. to display Key & Display and press to select.

Operating this unit

4 Turn M.C. to select the illumination color.

You can select one option from the following list.

- **27** preset colors (**WHITE** to **ROSE**)
- **SCAN** (cycle through all colors)
- Three sets of colors (**WARM**, **AMBIENT**, **CALM**)

Notes

- You cannot select **CUSTOM** in this function.
- Once you select a color in this function, colors on the keys and display of this unit automatically switch to the color you selected.
- For details about colors on the list, refer to *Selecting the key color from the illumination color list* on the previous page.

Customizing the illumination color

1 Press M.C. to display the main menu.

2 Turn M.C. to change the menu option and press to select ILLUMI.

3 Turn M.C. to display Key or Display. Press to select.

4 Press M.C. and hold until the customizing illumination color setting appears in the display.

5 Press M.C. to select the primary color. R (red)—G (green)—B (blue)

6 Turn M.C. to adjust the brightness level.

Adjustment range: **0** to **60**

- You cannot select a level below **20** for all three of **R** (red), **G** (green), and **B** (blue) at the same time.
- You can also perform the same operation on other colors.

Notes

- You cannot create a custom illumination color when **SCAN** or a set of colors (**WARM**, **AMBIENT**, or **CALM**) is selected.
- You can create custom illumination colors for both **Key** and **Display**.

Switching the display indication and button illumination

Display indication and button illumination can be switched on or off.

● Press and hold EQ/DISP OFF.

Pressing and holding **EQ/DISP OFF** switches the display indication and button illumination on or off.

- Even if the display indication is turned off, operation can be conducted. If operation is conducted while the display indication is off, display will light up for a few seconds and then turn off again.

Additional information

Troubleshooting

Symptom	Cause	Action
The display automatically returns to the ordinary display.	You did not perform any operation within about 30 seconds.	Perform operation again.
The repeat play range changes unexpectedly.	Depending on the repeat play range, the selected range may change when another folder or track is being selected or during fast forwarding/reversing.	Select the repeat play range again.
A subfolder is not played back.	Subfolders cannot be played when Folder repeat (folder repeat) is selected.	Select another repeat play range.
NO XXXX appears when a display is changed (NO TITLE , for example).	There is no embedded text information.	Switch the display or play another track/file.
The display screen changes at random.	Demo mode is on.	<ul style="list-style-type: none"> Press and hold DISP to cancel demo mode. Turn off the demo display setting.
The display screen changes at random instead of displaying the clock continuously even with the clock display turned on.	Demo mode is on.	<ul style="list-style-type: none"> Press and hold DISP to cancel demo mode. Turn off the demo display setting.
The display screen changes at random even with the display off turned on.	Demo mode is on.	<ul style="list-style-type: none"> Press and hold DISP to cancel demo mode. Turn off the demo display setting.

Symptom	Cause	Action
The display indication does not turn off when EQ/DISP OFF is pressed and held down.	Demo mode is on.	<ul style="list-style-type: none"> Press and hold DISP to cancel demo mode. Turn off the demo display setting.
The unit is malfunctioning. There is interference.	You are using a device, such as a cellular phone, that transmits electric waves near the unit.	Move electrical devices that may be causing the interference away from the unit.
The sound from the Bluetooth audio source is not played back.	There is a call in progress on a Bluetooth connected cellular phone.	The sound will be played back when the call is terminated.
	A Bluetooth connected cellular phone is currently being operated.	Do not operate the cellular phone at this time.
	A call was made with a Bluetooth connected cellular phone and then immediately terminated. As a result, communication between this unit and the cellular phone was not terminated properly.	Reconnect the Bluetooth connection between this unit and the cellular phone.
Text information cannot be scrolled.	Display scrolling is stopped automatically when the temperature around this unit is 50°F or less.	Wait until it warms back up.
Movie playback is stopped and the simple display appears.	Movie playback is stopped automatically when the temperature around this unit is 50°F or less.	Wait until it warms back up.

Additional information

Symptom	Cause	Action
Sound from the iPod cannot be heard.	The audio output direction may switch automatically when the Bluetooth and USB connections are used at the same time.	Use the iPod to change the audio output direction.



Error messages

When you contact your dealer or your nearest Pioneer Service Center, be sure to note the error message.

CD player

Message	Cause	Action
ERROR-07, 11, 12, 17, 30	The disc is dirty.	Clean the disc.
	The disc is scratched.	Replace the disc.
ERROR-10, 11, 12, 15, 17, 30, A0	There is an electrical or mechanical error.	Turn the ignition switch OFF and back ON, or switch to a different source, then back to the CD player.
ERROR-15	The inserted disc is blank.	Replace the disc.
ERROR-23	Unsupported CD format.	Replace the disc.
FORMAT READ	Sometimes there is a delay between the start of playback and when you start to hear any sound.	Wait until the message disappears and you hear sound.
NO AUDIO	The inserted disc does not contain any playable files.	Replace the disc.
SKIPPED	The inserted disc contains DRM protected files.	Replace the disc.
PROTECT	All the files on the inserted disc are embedded with DRM.	Replace the disc.

External storage device (USB, SD)/iPod

Message	Cause	Action
NO DEVICE	No USB storage device or iPod is connected.	Connect a compatible USB storage device/iPod.
FORMAT READ	Sometimes there is a delay between the start of playback and when you start to hear any sound.	Wait until the message disappears and you hear sound.
NO AUDIO	There are no songs.	Transfer the audio files to the USB storage device and connect.
	The connected USB storage device has security enabled.	Follow the USB storage device instructions to disable the security.
SKIPPED	The connected USB storage device contains files embedded with Windows Media™ DRM 9/10.	Play an audio file not embedded with Windows Media DRM 9/10.
PROTECT	All the files in the USB storage device are embedded with Windows Media DRM 9/10.	Transfer audio files not embedded with Windows Media DRM 9/10 to the USB storage device and connect.
NOT COMPATIBLE	The USB device connected to is not supported by this unit.	<ul style="list-style-type: none"> • Connect a USB Mass Storage Class compliant device. • Disconnect your device and replace it with a compatible USB storage device.
	Non-compatible iPod	Disconnect your device and replace it with a compatible iPod.
	Non-compatible SD storage device	Remove your device and replace it with a compatible SD storage device.

Additional information

Message	Cause	Action
CHECK USB	The USB connector or USB cable has short-circuited.	Check that the USB connector or USB cable is not caught in something or damaged.
	The connected USB storage device consumes more than maximum allowable current.	Disconnect the USB storage device and do not use it. Turn the ignition switch to OFF, then to ACC or ON and then connect only compliant USB storage devices.
	The iPod operates correctly but does not charge.	Make sure the connection cable for the iPod has not shorted out (e.g., not caught in metal objects). After checking, turn the ignition switch OFF and back ON, or disconnect the iPod and reconnect.
ERROR-19	Communication failed.	<ul style="list-style-type: none"> • Perform one of the following operations. <ul style="list-style-type: none"> –Turn the ignition switch OFF and back ON. –Disconnect or eject the external storage device. –Change to a different source. Then, return to the USB or SD source. • Disconnect the cable from the iPod. Once the iPod's main menu is displayed, reconnect the iPod and reset it.
	iPod failure.	Disconnect the cable from the iPod. Once the iPod's main menu is displayed, reconnect the iPod and reset it.

Message	Cause	Action
ERROR-23	USB storage device was not formatted with FAT12, FAT16 or FAT32.	USB storage device should be formatted with FAT12, FAT16 or FAT32.
ERROR-16	The iPod firmware version is old.	Update the iPod version.
	iPod failure.	Disconnect the cable from the iPod. Once the iPod's main menu is displayed, reconnect the iPod and reset it.
STOP	There are no songs in the current list.	Select a list that contains songs.
Not found	No related songs.	Transfer songs to the iPod.

Bluetooth device

Message	Cause	Action
ERROR-10	The power failed for the Bluetooth module of this unit.	Turn the ignition switch OFF and then to ACC or ON. If the error message is still displayed after performing the above action, please contact your dealer or an authorized Pioneer Service Station.

Pandora

Message	Cause	Action
ERROR-19	Communication failed.	Disconnect the cable from the iPod. Once the iPod's main menu is displayed, reconnect the iPod and reset it.
Start up the Pandora Application	The Pandora application has not started running yet.	Start up the Pandora application from your iPod/iPhone.

Additional information

Message	Cause	Action
Try again later	Unable to save thumb rating. Unable to save BookMark. Pandora system is undergoing maintenance.	Try again later.
Skip limit reached	Skip limit reached.	Do not exceed the skip limit.
Check Application	This version of the Pandora application is not supported.	Connect an iPod/iPhone that has a compatible version of the Pandora application installed.
Check Device	Device error message displayed in Pandora Application. Unable to play music from Pandora.	Please check your iPod/iPhone.
No Available Station	No station found.	Create a station in the Pandora application on your iPod/iPhone.
No Active Stations	No station selected.	Select a station.

Auto TA and EQ

Message	Cause	Action
ERR:MIC check	The microphone is not connected.	Plug the supplied microphone securely into the jack.
ERR:Front Speaker, ERR:Front-Lch, ERR:Front-Rch, ERR:Rear-Lch, ERR:Rear-Rch, ERR:SubW-Lch, ERR:SubW-Rch, ERR:SubWoofer	The microphone cannot pick up the measuring tone of a speaker.	<ul style="list-style-type: none"> • Confirm that the speakers are connected correctly. • Cancel muting the front speaker units. • Correct the input level setting of the power amp connected to the speakers. • Set the microphone correctly.

Message	Cause	Action
ERR:Outside Noise	The surrounding noise level is too high.	<ul style="list-style-type: none"> • Stop your car in a place that is quiet, and switch off the engine, air conditioner and heater. • Set the microphone correctly.

Handling guidelines

Discs and player

Use only discs that feature either of the following two logos.



Use 12-cm discs. Do not use 8-cm discs or an adapter for 8-cm discs.

Use only conventional, fully circular discs. Do not use shaped discs.



Do not insert anything other than a CD into the CD loading slot.

Do not use cracked, chipped, warped, or otherwise damaged discs as they may damage the player.

Unfinalized CD-R/RW discs cannot be played back.

Do not touch the recorded surface of the discs.

Store discs in their cases when not in use.

Do not attach labels, write on or apply chemicals to the surface of the discs.

To clean a CD, wipe the disc with a soft cloth outward from the center.

Additional information

Condensation may temporarily impair the player's performance. Let it rest for about one hour to adjust to a warmer temperature. Also, wipe any damp discs off with a soft cloth.

Playback of discs may not be possible because of disc characteristics, disc format, recorded application, playback environment, storage conditions, and so on.

Road shocks may interrupt disc playback.

When using discs that can be printed on label surfaces, check the instructions and the warnings of the discs. Depending on the discs, inserting and ejecting may not be possible. Using such discs may result in damage to this equipment.

Do not attach commercially available labels or other materials to the discs.

- The discs may warp making the disc unplayable.
- The labels may come off during playback and prevent ejection of the discs, which may result in damage to the equipment.

External storage device (USB, SD)

Address any questions you have about your external storage device (USB, SD) to the manufacturer of the device.

Do not leave the external storage device (USB, SD) in places with high temperatures.

Depending on the external storage device (USB, SD), the following problems may occur.

- Operations may vary.
- The storage device may not be recognized.
- Files may not be played back properly.

USB storage device

Connections via USB hub are not supported.

Do not connect anything other than a USB storage device.

Firmly secure the USB storage device when driving. Do not let the USB storage device fall onto the floor, where it may become jammed under the brake or accelerator pedal.

Depending on the USB storage device, the following problems may occur.

- The device may generate noise in the radio.

SD memory card

This unit supports only the following types of SD memory cards.

- SD
- miniSD
- microSD
- SDHC

Keep the SD memory card out of the reach of children. Should the SD memory card be swallowed, consult a doctor immediately.

Do not touch the connectors of the SD memory card directly with your fingers or with any metal device.

Do not insert anything other than an SD memory card into the SD card slot. If a metal object (such as a coin) is inserted into the slot, the internal circuits may break and cause malfunctions.

When inserting a miniSD or microSD, use an adapter. Do not use an adapter which has metal parts other than the connectors exposed.

Do not insert a damaged SD memory card (e.g. warped, label peeled off) as it may not be ejected from the slot.

Do not try to force an SD memory card into the SD card slot as the card or this unit may be damaged.

When ejecting an SD memory card, press it and hold it until it clicks. It is dangerous for you to release your finger immediately after you press on the card as the card may shoot out of the slot and hit you in the face, etc. If the card shoots out of the slot, it may become lost.

iPod

To ensure proper operation, connect the dock connector cable from the iPod directly to this unit.

Firmly secure the iPod when driving. Do not let the iPod fall onto the floor, where it may become jammed under the brake or accelerator pedal.

About iPod settings

- When an iPod is connected, this unit changes the EQ (equalizer) setting of the iPod to off in order to optimize the acoustics. When you disconnect the iPod, the EQ returns to the original setting.
- You cannot set Repeat to off on the iPod when using this unit. Repeat is automatically changed to All when the iPod is connected to this unit.

Incompatible text saved on the iPod will not be displayed by the unit.

Additional information

DualDiscs

DualDiscs are two-sided discs that have a recordable CD for audio on one side and a recordable DVD for video on the other.

Since the CD side of DualDiscs is not physically compatible with the general CD standard, it may not be possible to play the CD side with this unit.

Frequent loading and ejecting of a DualDisc may result in scratches on the disc. Serious scratches can lead to playback problems on this unit. In some cases, a DualDisc may become stuck in the disc loading slot and will not eject. To prevent this, we recommend you refrain from using DualDisc with this unit. Please refer to the information from the disc manufacturer for more detailed information about DualDiscs.

CAUTION

Do not leave the discs/external storage device (USB, SD) or iPod in places with high temperatures. 

Compressed audio compatibility (disc, USB, SD)

WMA

File extension: .wma

Bit rate: 48 kbps to 320 kbps (CBR), 48 kbps to 384 kbps (VBR)

Sampling frequency: 32 kHz, 44.1 kHz, 48 kHz

Windows Media Audio Professional, Lossless, Voice/DRM Stream/Stream with video: Not compatible

MP3

File extension: .mp3

Bit rate: 8 kbps to 320 kbps (CBR), VBR

Sampling frequency: 8 kHz to 48 kHz (32 kHz, 44.1 kHz, 48 kHz for emphasis)

Compatible ID3 tag version: 1.0, 1.1, 2.2, 2.3, 2.4 (ID3 tag Version 2.x is given priority over Version 1.x.)

M3u playlist: Not compatible

MP3i (MP3 interactive), mp3 PRO: Not compatible

WAV

File extension: .wav

Quantization bits: 8 and 16 (LPCM), 4 (MS ADPCM)

Sampling frequency: 16 kHz to 48 kHz (LPCM), 22.05 kHz and 44.1 kHz (MS ADPCM)

AAC

Compatible format: AAC encoded by iTunes

File extension: .m4a

Sampling frequency: 11.025 kHz to 48 kHz

Transmission rate: 16 kbps to 320 kbps, VBR

Apple Lossless: Not compatible

AAC file bought from the iTunes Store (.m4p file extension): Not compatible

Supplemental information

Only the first 32 characters can be displayed as a file name (including the file extension) or a folder name.

This unit may not operate correctly depending on the application used to encode WMA files.

There may be a slight delay at the start of playback of audio files embedded with image data or audio files stored on a USB storage device that has numerous folder hierarchies.

Disc

Playable folder hierarchy: up to eight tiers (A practical hierarchy is less than two tiers).

Playable folders: up to 99

Playable files: up to 999

File system: ISO 9660 Level 1 and 2, Romeo, Joliet

Multi-session playback: Compatible

Packet write data transfer: Not compatible

Regardless of the length of blank sections between the songs from the original recording, compressed audio discs play with a short pause between songs.

Additional information

External storage device (USB, SD)

Playable folder hierarchy: up to eight tiers (A practical hierarchy is less than two tiers).

Playable folders: up to 1 500

Playable files: up to 15 000

Playback of copyright-protected files: Not compatible

Partitioned external storage device (USB, SD): Only the first playable partition can be played.

There may be a slight delay when starting playback of audio files on a USB storage device with numerous folder hierarchies.

SD memory card

There is no compatibility for Multi Media Cards (MMC).

Compatibility with all SD memory cards is not guaranteed.

This unit is not compatible with SD-Audio.



CAUTION

- Pioneer accepts no responsibility for data lost on USB memory/USB portable audio players/SD memory cards/SDHC memory cards, even if that data is lost while this unit is used.
- Pioneer cannot guarantee compatibility with all USB mass storage devices and assumes no responsibility for any loss of data on media players, smart phones, or other devices while using this product. 

iPod compatibility

This unit supports only the following iPod models. Supported iPod software versions are shown below. Older versions may not be supported.

Made for

- iPod touch 4th generation (software version 4.1)
- iPod touch 3rd generation (software version 3.1.1)
- iPod touch 2nd generation (software version 2.1.1)
- iPod touch 1st generation (software version 1.1)
- iPod classic 160GB (software version 2.0.2)
- iPod classic 120GB (software version 2.0)
- iPod classic (software version 1.0)
- iPod with video (software version 1.2.3)
- iPod nano 6th generation (software version 1.0)
- iPod nano 5th generation (software version 1.0.1)
- iPod nano 4th generation (software version 1.0)
- iPod nano 3rd generation (software version 1.0)
- iPod nano 2nd generation (software version 1.1.3)
- iPod nano 1st generation (software version 1.3.1)
- iPhone 4 (software version 4.1)
- iPhone 3GS (software version 3.0)
- iPhone 3G (software version 2.0)
- iPhone (software version 1.1.1)

Depending on the generation or version of the iPod, some functions may not be available.

Operations may vary depending on the software version of iPod.

When using an iPod, an iPod Dock Connector to USB Cable is required.

A Pioneer CD-IU51 interface cable is also available. For details, consult your dealer.

About the file/format compatibility, refer to the iPod manuals.

Audiobook, Podcast: Compatible



CAUTION

Pioneer accepts no responsibility for data lost on the iPod, even if that data is lost while this unit is used. 

Sequence of audio files

The user cannot assign folder numbers and specify playback sequences with this unit.

Additional information

Example of a hierarchy

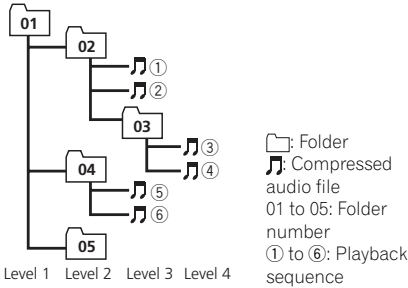

Disc

Folder selection sequence or other operation may differ depending on the encoding or writing software.

External storage device (USB, SD)

The playback sequence is the same as the recorded sequence in the external storage device (USB, SD).

To specify the playback sequence, the following method is recommended.

- ① Create a file name that includes numbers that specify the playback sequence (e.g., 001xxx.mp3 and 099yyy.mp3).
- ② Put those files into a folder.
- ③ Save the folder that contains the files to the external storage device (USB, SD).

However, depending on the system environment, you may not be able to specify the playback sequence.

For USB portable audio players, the sequence is different and depends on the player. □

Bluetooth profiles

In order to use Bluetooth wireless technology, devices must be able to interpret certain profiles. This unit is compatible with the following profiles.

- GAP (Generic Access Profile)
- SDP (Service Discovery Protocol)
- OPP (Object Push Profile)
- HFP (Hands Free Profile)
- HSP (Head Set Profile)

- PBAP (Phone Book Access Profile)
- A2DP (Advanced Audio Distribution Profile)
- AVP (Audio/Video Profile)
- AVRCP (Audio/Video Remote Control Profile) 1.0 □

Copyright and trademark

Bluetooth

The *Bluetooth*® word mark and logos are registered trademarks owned by Bluetooth SIG, Inc. and any use of such marks by PIONEER CORPORATION is under license. Other trademarks and trade names are those of their respective owners.

iTunes

Apple and iTunes are trademarks of Apple Inc., registered in the U.S. and other countries.

MP3

Supply of this product only conveys a license for private, non-commercial use and does not convey a license nor imply any right to use this product in any commercial (i.e. revenue-generating) real time broadcasting (terrestrial, satellite, cable and/or any other media), broadcasting/streaming via internet, intranets and/or other networks or in other electronic content distribution systems, such as pay-audio or audio-on-demand applications. An independent license for such use is required. For details, please visit <http://www.mp3licensing.com>.

WMA

Windows Media is either a registered trademark or trademark of Microsoft Corporation in the United States and/or other countries. This product includes technology owned by Microsoft Corporation and cannot be used or distributed without a license from Microsoft Licensing, Inc.

SD memory card

SD Logo is a trademark of SD-3C, LLC.

Additional information

miniSD Logo is a trademark of SD-3C, LLC.
microSD Logo is a trademark of SD-3C, LLC.
SDHC Logo is a trademark of SD-3C, LLC.

iPod & iPhone

iPhone, iPod, iPod classic, iPod nano, and iPod touch are trademarks of Apple Inc., registered in the U.S. and other countries.

“Made for iPod” and “Made for iPhone” mean that an electronic accessory has been designed to connect specifically to iPod or iPhone, respectively, and has been certified by the developer to meet Apple performance standards. Apple is not responsible for the operation of this device or its compliance with safety and regulatory standards. Please note that the use of this accessory with iPod or iPhone may affect wireless performance.

Pandora

Pandora is a registered trademark of Pandora Media, Inc.

Additional information

Specifications

General

Power source	14.4 V DC (10.8 V to 15.1 V allowable)
Grounding system	Negative type
Maximum current consumption	10.0 A
Dimensions (W × H × D):	
DIN	
Chassis	178 mm × 50 mm × 165 mm (7 in. × 2 in. × 6-1/2 in.)
Nose	188 mm × 58 mm × 17 mm (7-3/8 in. × 2-1/4 in. × 5/8 in.)
D	
Chassis	178 mm × 50 mm × 165 mm (7 in. × 2 in. × 6-1/2 in.)
Nose	170 mm × 46 mm × 17 mm (6-3/4 in. × 1-3/4 in. × 5/8 in.)
Weight	1.2 kg (2.6 lbs)

Audio

Maximum power output	50 W × 4
Continuous power output ...	22 W × 4 (50 Hz to 15 000 Hz, 5% THD, 4 Ω load, both channels driven)
Load impedance	4 Ω to 8 Ω × 4
Preout maximum output level	5.0 V
Loudness contour	+10 dB (100 Hz), +6.5 dB (10 kHz) (volume: -30 dB)
Equalizer (Left/Right independent 16-Band Graphic Equalizer):	
Frequency	20 Hz/31.5 Hz/50 Hz/80 Hz/125 Hz/200 Hz/315 Hz/500 Hz/800 Hz/1.25 kHz/2 kHz/3.15 kHz/5 kHz/8 kHz/12.5 kHz/20 kHz
Equalization range	±12 dB (2 dB step)
Auto equalizer:	
(Front & rear & subwoofer/High & mid & low)	
Frequency	20 Hz/31.5 Hz/50 Hz/80 Hz/125 Hz/200 Hz/315 Hz/500 Hz/800 Hz/1.25 kHz/2 kHz/3.15 kHz/5 kHz/8 kHz/12.5 kHz/20 kHz
Equalization range	+6 dB to -12 dB (2 dB step)
Network (standard mode):	
HPF (front)	
Frequency	50 Hz/63 Hz/80 Hz/100 Hz/125 Hz/160 Hz/200 Hz

Slope	0 (Pass)/-6 dB/oct./-12 dB/oct.
Gain	0 dB to -24 dB/Mute (1 dB step)
HPF (rear)	
Frequency	50 Hz/63 Hz/80 Hz/100 Hz/125 Hz/160 Hz/200 Hz
Slope	0 (Pass)/-6 dB/oct./-12 dB/oct.
Gain	+6 dB to -24 dB/Mute (1 dB step)
Subwoofer (stereo/mono):	
Frequency	50 Hz/63 Hz/80 Hz/100 Hz/125 Hz/160 Hz/200 Hz
Slope	-6 dB/oct./-12 dB/oct./-18 dB/oct.
Gain	+6 dB to -24 dB/Mute (1 dB step)
Phase	Normal/Reverse
Network (3-way network mode):	
High HPF:	
Frequency	1.25 kHz/1.6 kHz/2 kHz/2.5 kHz/3.15 kHz/4 kHz/5 kHz/6.3 kHz/8 kHz/10 kHz/12.5 kHz
Slope	-6 dB/oct./-12 dB/oct./-18 dB/oct./-24 dB/oct.
Gain	0 dB to -24 dB/Mute (1 dB step)
Phase	Normal/Reverse
Mid HPF/LPF:	
Frequency (LPF) ...	1.25 kHz/1.6 kHz/2 kHz/2.5 kHz/3.15 kHz/4 kHz/5 kHz/6.3 kHz/8 kHz/10 kHz/12.5 kHz
Frequency (HPF)	25 Hz/31.5 Hz/40 Hz/50 Hz/63 Hz/80 Hz/100 Hz/125 Hz/160 Hz/200 Hz/250 Hz
Slope (LPF)	0 (Pass)/-6 dB/oct./-12 dB/oct./-18 dB/oct./-24 dB/oct.
Slope (HPF)	0 (Pass)/-6 dB/oct./-12 dB/oct./-18 dB/oct./-24 dB/oct.
Gain	0 dB to -24 dB/Mute (1 dB step)
Phase	Normal/Reverse
Low LPF (stereo/mono):	
Frequency	25 Hz/31.5 Hz/40 Hz/50 Hz/63 Hz/80 Hz/100 Hz/125 Hz/160 Hz/200 Hz/250 Hz
Slope	-12 dB/oct./-18 dB/oct./-24 dB/oct./-30 dB/oct./-36 dB/oct.

Additional information

Gain +6 dB to -24 dB/Mute (1 dB step)
Phase Normal/Reverse

CD player

System Compact disc audio system
Usable discs Compact disc
Signal-to-noise ratio 105 dB (1 kHz) (IHF-A network)
Number of channels 2 (stereo)
MP3 decoding format MPEG-1 & 2 Audio Layer 3
WMA decoding format Ver. 7, 7.1, 8, 9, 10, 11, 12 (2 ch audio) (Windows Media Player)
AAC decoding format MPEG-4 AAC (iTunes encoded only) (.m4a) (Ver. 10.4 and earlier)
WAV signal format Linear PCM & MS ADPCM (Non-compressed)

USB

USB standard specification USB 2.0 full speed
Maximum current supply ... 1 A
USB Class MSC (Mass Storage Class)
File system FAT12, FAT16, FAT32
MP3 decoding format MPEG-1 & 2 Audio Layer 3
WMA decoding format Ver. 7, 7.1, 8, 9, 10, 11, 12 (2 ch audio) (Windows Media Player)
AAC decoding format MPEG-4 AAC (iTunes encoded only) (.m4a) (Ver. 10.4 and earlier)
WAV signal format Linear PCM & MS ADPCM (Non-compressed)

SD

Compatible physical format Version 2.00
Maximum memory capacity 32 GB (for SD and SDHC)
File system FAT12, FAT16, FAT32
MP3 decoding format MPEG-1 & 2 Audio Layer 3
WMA decoding format Ver. 7, 7.1, 8, 9, 10, 11, 12 (2 ch audio) (Windows Media Player)
AAC decoding format MPEG-4 AAC (iTunes encoded only) (.m4a) (Ver. 10.4 and earlier)
WAV signal format Linear PCM & MS ADPCM (Non-compressed)

FM tuner

Frequency range 87.9 MHz to 107.9 MHz

Usable sensitivity 9 dBf (0.8 μ V/75 Ω mono, S/N: 30 dB)
Signal-to-noise ratio 72 dB (IHF-A network)

AM tuner

Frequency range 530 kHz to 1 710 kHz
Usable sensitivity 25 μ V (S/N: 20 dB)
Signal-to-noise ratio 62 dB (IHF-A network)

Bluetooth

Version Bluetooth 3.0 certified
Output power +4 dBm Maximum (Power class 2)

CEA2006 Specifications



Power output 14 W RMS \times 4 Channels (4 Ω and \leq 1% THD+N)
S/N ratio 91 dBA (reference: 1 W into 4 Ω)

Note

Specifications and the design are subject to modifications without notice.

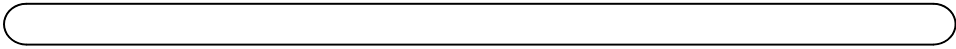

130.com.ua

*Register your product at
Enregistrez votre produit au
Registre su producto en*

<http://www.pioneerelectronics.com>

*See "Visit our website" page
Voir la page "Visitez notre site Web"
Consulte la página sobre "Visite nuestro sitio Web"*

PIONEER CORPORATION

28-8, Honkomagome 2-chome, Bunkyo-ku,
Tokyo 113-0021, JAPAN

PIONEER ELECTRONICS (USA) INC.

P.O. Box 1540, Long Beach, California 90801-1540, U.S.A.
TEL: (800) 421-1404

PIONEER EUROPE NV

Haven 1087, Keetberglaan 1, B-9120 Melsele, Belgium/Belgique
TEL: (0) 3/570.05.11

PIONEER ELECTRONICS ASIACENTRE PTE. LTD.

2 Jalan Kilang Barat, #07-01, Singapore 159346
TEL: 65-6378-7888

PIONEER ELECTRONICS AUSTRALIA PTY. LTD.

5 Arco Lane, Heatherton, Victoria, 3202 Australia
TEL: (03) 9586-6300

PIONEER ELECTRONICS OF CANADA, INC.

340 Ferrier Street, Unit 2, Markham, Ontario L3R 2Z5, Canada
TEL: 1-877-283-5901
TEL: 905-479-4411

PIONEER ELECTRONICS DE MÉXICO S.A. de C.V.

Bvd.Manuel Ávila Camacho 138, 10 piso
Col.Lomas de Chapultepec, México, D.F. 11000
TEL: 52-55-9178-4270
FAX: 52-55-5202-3714

先鋒股份有限公司

台北市內湖區瑞光路407號8樓
電話：886-(0)2-2657-3588

先鋒電子（香港）有限公司

香港九龍長沙灣道909號5樓
電話：852-2848-6488

© 2011-2016 PIONEER CORPORATION.
All rights reserved.