

ONKYO

NETWORK RECEIVER

R-N855

Instruction Manual

Thank you for purchasing an Onkyo product. Please read this manual carefully before making any connections or using this product. By following these instructions, you'll get the best audio performance and the most listening pleasure from your Onkyo product. Keep this manual for future reference.

Getting StartedEn-2

Connections En-10

Initial Setup..... En-12

Playback..... En-14

Supplementary information.... En-29

Advanced Setup En-30

Troubleshooting En-35

Specifications..... En-38



WARNING:

TO REDUCE THE RISK OF FIRE OR ELECTRIC SHOCK, DO NOT EXPOSE THIS APPARATUS TO RAIN OR MOISTURE.

CAUTION:

TO REDUCE THE RISK OF ELECTRIC SHOCK, DO NOT REMOVE COVER (OR BACK). NO USER-SERVICEABLE PARTS INSIDE. REFER SERVICING TO QUALIFIED SERVICE PERSONNEL.



WARNING
RISK OF ELECTRIC SHOCK
DO NOT OPEN

AVIS
RISQUE DE CHOC ELECTRIQUE
NE PAS OUVRIR



The lightning flash with arrowhead symbol, within an equilateral triangle, is intended to alert the user to the presence of uninsulated "dangerous voltage" within the product's enclosure that may be of sufficient magnitude to constitute a risk of electric shock to persons.



The exclamation point within an equilateral triangle is intended to alert the user to the presence of important operating and maintenance (servicing) instructions in the literature accompanying the appliance.

Important Safety Instructions

1. Read these instructions.
2. Keep these instructions.
3. Heed all warnings.
4. Follow all instructions.
5. Do not use this apparatus near water.
6. Clean only with dry cloth.
7. Do not block any ventilation openings. Install in accordance with the manufacturer's instructions.
8. Do not install near any heat sources such as radiators, heat registers, stoves, or other apparatus (including amplifiers) that produce heat.
9. Do not defeat the safety purpose of the polarized or grounding-type plug. A polarized plug has two blades with one wider than the other. A grounding type plug has two blades and a third grounding prong. The wide blade or the third prong are provided for your safety. If the provided plug does not fit into your outlet, consult an electrician for replacement of the obsolete outlet.
10. Protect the power cord from being walked on or pinched particularly at plugs, convenience receptacles, and the point where they exit from the apparatus.
11. Only use attachments/accessories specified by the manufacturer.
12. Use only with the cart, stand, tripod, bracket, or table specified by the manufacturer, or sold with the apparatus. When a cart is used, use caution when moving the cart/apparatus combination to avoid injury from tip-over.

PORTABLE CART WARNING
S3125A
13. Unplug this apparatus during lightning storms or when unused for long periods of time.
14. Refer all servicing to qualified service personnel. Servicing is required when the apparatus has been damaged in any way, such as power-supply cord or plug is damaged, liquid has been spilled or objects have fallen into the apparatus, the apparatus has been exposed to rain or moisture, does not operate normally, or has been dropped.
15. Damage Requiring Service
Unplug the apparatus from the wall outlet and refer servicing to qualified service personnel under the following conditions:
 - A. When the power-supply cord or plug is damaged,
 - B. If liquid has been spilled, or objects have fallen into the apparatus,
 - C. If the apparatus has been exposed to rain or water,
 - D. If the apparatus does not operate normally by following the operating instructions. Adjust only those controls that are covered by the operating instructions as an improper adjustment of other controls may result in damage and will often require extensive work by a qualified technician to restore the apparatus to its normal operation,
 - E. If the apparatus has been dropped or damaged in any way, and
 - F. When the apparatus exhibits a distinct change in performance this indicates a need for service.
16. Object and Liquid Entry
Never push objects of any kind into the apparatus through openings as they may touch dangerous voltage points or short-out parts that could result in a fire or electric shock.
The apparatus shall not be exposed to dripping or splashing and no objects filled with liquids, such as vases shall be placed on the apparatus.
Don't put candles or other burning objects on top of this unit.
17. Batteries
Always consider the environmental issues and follow local regulations when disposing of batteries.
18. If you install the apparatus in a built-in installation, such as a bookcase or rack, ensure that there is adequate ventilation.
Leave 20 cm (8") of free space at the top and sides and 10 cm (4") at the rear. The rear edge of the shelf or board above the apparatus shall be set 10 cm (4") away from the rear panel or wall, creating a flue-like gap for warm air to escape.

Precautions

1. **Recording Copyright**—Unless it's for personal use only, recording copyrighted material is illegal without the permission of the copyright holder.
2. **AC Fuse**—The AC fuse inside the unit is not user-serviceable. If you cannot turn on the unit, contact the dealer from whom you purchased this unit.
3. **Care**—Occasionally you should dust the unit all over with a soft cloth. For stubborn stains, use a soft cloth dampened with a weak solution of mild detergent and water. Dry the unit immediately afterwards with a clean cloth. Don't use abrasive cloths, thinners, alcohol, or other chemical solvents, because they may damage the finish or remove the panel lettering.

4. Power

WARNING

BEFORE PLUGGING IN THE UNIT FOR THE FIRST TIME, READ THE FOLLOWING SECTION CAREFULLY.

AC outlet voltages vary from country to country. Make sure that the voltage in your area meets the voltage requirements printed on the unit's rear panel (e.g., AC 220-240 V, 50/60 Hz or AC 120 V, 60 Hz).

The power cord plug is used to disconnect this unit from the AC power source. Make sure that the plug is readily operable (easily accessible) at all times.

Pressing the [ON/STANDBY] button to select Standby mode does not fully disconnect from the mains. If you do not intend to use the unit for an extended period, remove the power cord from the AC outlet.

5. Preventing Hearing Loss

Caution

Excessive sound pressure from earphones and headphones can cause hearing loss.

6. Batteries and Heat Exposure

Warning

Batteries (battery pack or batteries installed) shall not be exposed to excessive heat as sunshine, fire or the like.

7. **Never Touch this Unit with Wet Hands**—Never handle this unit or its power cord while your hands are wet or damp. If water or any other liquid gets inside this unit, have it checked by the dealer from whom you purchased this unit.

8. Handling Notes

- If you need to transport this unit, use the original packaging to pack it how it was when you originally bought it.
- Do not leave rubber or plastic items on this unit for a long time, because they may leave marks on the case.
- This unit's top and rear panels may get warm after prolonged use. This is normal.
- If you do not use this unit for a long time, it may not work properly the next time you turn it on, so be sure to use it occasionally.

9. Cautions regarding Wi-Fi and BLUETOOTH® features

[*] R-N855

This [*] uses radio waves in the 2.4 GHz and 5 GHz frequency bands. There are nations and regions

where the use of particular 5 GHz bands are prohibited outdoors, so do not use this unit outside in those places.

10. WARNING

Store small parts out of the reach of children and infants. If accidentally swallowed, contact a doctor immediately.

For British models

Replacement and mounting of an AC plug on the power supply cord of this unit should be performed only by qualified service personnel.

IMPORTANT

The wires in the mains lead are coloured in accordance with the following code:

Blue: Neutral

Brown: Live

As the colours of the wires in the mains lead of this apparatus may not correspond with the coloured markings identifying the terminals in your plug, proceed as follows:

The wire which is coloured blue must be connected to the terminal which is marked with the letter N or coloured black.

The wire which is coloured brown must be connected to the terminal which is marked with the letter L or coloured red.

IMPORTANT

The plug is fitted with an appropriate fuse. If the fuse needs to be replaced, the replacement fuse must be approved by ASTA or BSI to BS1362 and have the same ampere rating as that indicated on the plug. Check for the ASTA mark or the BSI mark on the body of the fuse. If the power cord's plug is not suitable for your socket outlets, cut it off and fit a suitable plug. Fit a suitable fuse in the plug.

For European Models

Restrictions : W52 and W53 bands are restricted if indoor operations only to all countries in EU. / Ограничения: Използването на ленти W52 и W53 не е позволено при дейността на закрито единствено във всички държави от ЕС. / Omezení: Pásmo W52 a W53 jsou ve všech zemích EU omezena pouze na používání v interiéru. / Begrænsninger: W52- og W53-bånd er begrænset til kun at omfatte indendørs brug i alle EU-lande. / Einschränkungen: Die Verwendung der Bänder W52 und W53 ist in allen EU-Ländern auf Innenräume beschränkt. / Piirangud: lainealad W52 ja W53 on mõeldud kasutamiseks ainult siseruumides kõigis EL-i riikides. / Περιόρισμοι: Οι ζώνες W52 και W53 περιορίζονται μόνο σε ενέργειες σε εσωτερικούς χώρους σε όλες τις χώρες της ΕΕ. / Restricciones: Las bandas W52 y W53 están restringidas a uso en interiores en todos los países de la Unión Europea. / Limitations : Les bandes W52 et W53 sont limitées à un usage intérieur dans tous les pays de l'UE. / Restrições: In tutti i paesi della UE le bande W52 e W53 possono essere utilizzate solo all'interno di edifici. / Ierobežojumi: W52 un W53 joslas li ierobežotas darbībai tikai iekšējās telpās visās ES valstīs. / Apríbojimai: W52 ir W53 veikimo dažnių naudojimas viduje apribotas visose ES šalyse. / Korlátozások : A W52 és W53 sávok beltéri használatra az Európai Unió minden országában tilos. / Bepierkingen: het gebruik van de banden W52 en W53 is beperkt tot alleen binnenshuis gebruik in alle landen van de EU. / Ograniczenia: Pasma W52 oraz W53 we wszystkich krajach Unii Europejskiej ograniczone są tylko do użytkowania wewnątrz budynków. / Restricções: As bandas W52 e W53 estão restritas a operações no interior em todos os países da UE. / Restricții: Benzile W52 și W53 pot fi utilizate doar în medii interioare în toate țările UE. / Obmedzenia: Iba W52 a W53 sú vo všetkých krajinách EÚ obmedzená na prevádzku iba vo vnútri. / Omejitve: frekvenčna pasova W52 in W53 sta v vseh državah EU omejena le na delovanje v zaprtih prostorih. / Rajoitukset: W52- ja W53-kaistat on rajoitettu käytettäväksi ainoastaan sisätiloissa kaikissa EU-maissa. / Begrænsningar: Användningen av band W52 och W53 är begränsad till att endast användas inomhus i alla EU-länder. / Ograniczenia: w svim državama EU-a, frekvencijski pojasevi W52 i W53 smiju se upotrebljavati samo u zatvorenim prostorima. / Restrições: Fil-pajjiżi kollha tal-UE, il-meded W52 u W53 huma għal użu fuq gewwa biss.

- Hereby, Onkyo & Pioneer Corporation declares that this product is in compliance with Directive 2014/53/EU. The full text of the EU declaration of conformity is available at the following internet address: <http://www.eu.onkyo.com/en/>
- С настоящото Onkyo & Pioneer Corporation декларира, че този продукт е в съответствие с Директива 2014/53/ЕС. Цялостният текст на ЕС декларацията за съответствие може да се намери на следния интернет адрес: <http://www.eu.onkyo.com/en/>
- Tímto Onkyo & Pioneer Corporation prohlašuje, že tento výrobek je v souladu se směrnicí 2014/53/EU. Úplně znění EU prohlášení o shodě je k dispozici na této internetové adrese: <http://www.eu.onkyo.com/en/>
- Hermed erklærer Onkyo & Pioneer Corporation, at dette produkt er i overensstemmelse med direktiv 2014/53/EU. EU-overensstemmelseserklæringens fulde tekst kan findes på følgende internetadresse: <http://www.eu.onkyo.com/en/>
- Hiermit erklárt Onkyo & Pioneer Corporation, dass dieses Produkt der Richtlinie 2014/53/EU entspricht. Der vollständige Text der EU-Konformitätserklärung ist unter der folgenden Internetadresse verfügbar: <http://www.eu.onkyo.com/en/>
- Käesolevaga deklareerib Onkyo & Pioneer Corporation, et see toode vastab direktiivi 2014/53/EL nõuetele. ELi vastavusdeklaratsiooni täielik tekst on kättesaadav järgmisel internetiaadressil: <http://www.eu.onkyo.com/en/>
- Με την παρούσα Onkyo & Pioneer Corporation, δηλώνει ότι αυτό το προϊόν πληροί την οδηγία 2014/53/ΕΕ. Το πλήρες κείμενο της δήλωσης συμμόρφωσης ΕΕ διατίθεται στην ακόλουθη ιστοσελίδα στο διαδίκτυο: <http://www.eu.onkyo.com/en/>
- Por la presente, Onkyo & Pioneer Corporation declara que este producto es conforme con la Directiva 2014/53/UE. El texto completo de la declaración UE de conformidad está disponible en la dirección Internet siguiente: <http://www.eu.onkyo.com/en/>
- Le soussigné, Onkyo & Pioneer Corporation, déclare que ce produit est conforme à la directive 2014/53/UE. Le texte complet de la déclaration UE de conformité est disponible à l'adresse internet suivante: <http://www.eu.onkyo.com/en/>
- Il fabbricante, Onkyo & Pioneer Corporation, dichiara che questo prodotto è conforme alla direttiva 2014/53/UE. Il testo completo della dichiarazione di conformità UE è disponibile al seguente indirizzo Internet: <http://www.eu.onkyo.com/en/>
- Ar šo Onkyo & Pioneer Corporation deklarē, ka šis produkts atbilst Direktīvai 2014/53/ES. Pilns ES atbilstības deklarācijas teksts ir pieejams šādā interneta vietnē: <http://www.eu.onkyo.com/en/>
- Aš, Onkyo & Pioneer Corporation, patvirtinu, kad šis produktas atitinka Direktyvą 2014/53/ES. Visas ES atitikties deklaracijos tekstas prieinamas šiuo interneto adresu: <http://www.eu.onkyo.com/en/>
- Onkyo & Pioneer Corporation igazolja, hogy ez a termék megfelel a 2014/53/EU irányelvnek. Az EU-megfelelőségi nyilatkozat teljes szövege elérhető a következő internetes címen: <http://www.eu.onkyo.com/en/>
- Hierbij verklaar ik, Onkyo & Pioneer Corporation, dat dit product conform is met Richtlijn 2014/53/EU. De volledige tekst van de EU-conformiteitsverklaring kan worden geraadpleegd op het volgende internetadres: <http://www.eu.onkyo.com/en/>
- Onkyo & Pioneer Corporation niniejszym oświadcza, że ten produkt jest zgodny z dyrektywą 2014/53/UE. Pełny tekst deklaracji zgodności UE jest dostępny pod następującym adresem internetowym: <http://www.eu.onkyo.com/en/>
- O(a) abaixo assinado(a) Onkyo & Pioneer Corporation declara que este produto está em conformidade com a Diretiva 2014/53/UE. O texto integral da declaração de conformidade está disponível no seguinte endereço de Internet: <http://www.eu.onkyo.com/en/>
- Prin prezenta, Onkyo & Pioneer Corporation declară că acest produs este în conformitate cu Directiva 2014/53/UE. Textul integral al declarației UE de conformitate este disponibil la următoarea adresă internet: <http://www.eu.onkyo.com/en/>
- Onkyo & Pioneer Corporation tímto vyhlasuje, že tento produkt je v súlade so smernicou 2014/53/EÚ. Úplné EÚ vyhlásenie o zhode je k dispozícii na tejto internetovej adrese: <http://www.eu.onkyo.com/en/>
- Onkyo & Pioneer Corporation potrjuje, da ta izdelek skladen z Direktivo 2014/53/EU. Celotno besedilo izjave EU o skladnosti je na voljo na naslednjem spletnem naslovu: <http://www.eu.onkyo.com/en/>
- Onkyo & Pioneer Corporation vakuuttaa, että tämä tuote on direktiivin 2014/53/EU mukainen. EU-vaatimustenmukaisuusvakuutuksen täysimittainen teksti on saatavilla seuraavassa internetosoitteessa: <http://www.eu.onkyo.com/en/>
- Härmed försäkrar Onkyo & Pioneer Corporation att den här produkten överensstämmer med direktiv 2014/53/EU. Den fullständiga texten till EU-försäkran om överensstämmelse finns på följande webbadress: <http://www.eu.onkyo.com/en/>
- Onkyo & Pioneer Corporation ovime izjavljuju da ovaj proizvod u skladu s Direktivom 2014/53/EU. Cjeloviti tekst EU izjave o skladnosti dostupan je na sljedećoj internetskoj adresi: <http://www.eu.onkyo.com/en/>
- B'dan, Onkyo & Pioneer Corporation, niddikjara li dan il-prodott huwa konformi mad-Direttiva 2014/53/UE. It-test kollu tad-dikjarazzjoni ta' konformita' tal-UE huwa disponibbli f'dan l-indirizz tal-Internet li ghej: <http://www.eu.onkyo.com/en/>

WEEE

<http://www.onkyo.com/manual/weee/weee.pdf>

Contents

What's in the box	5
Front Panel	6
Rear Panel	7
Remote Controller	8
Display	9
Connect the Speakers	10
Connecting the Antennas and Power Cord, etc.	11
Power On & Initial Setup	12
Time Settings	13
USB Storage Device/HDD Playback	14
Internet Radio	16
Spotify	17
Listening to the FM/DAB Radio	18
BLUETOOTH®	21
AirPlay®	22
Playing Audio from an External Device	23
Music Server	25
Using the Alarm to Start Play	27
Entering Text, Adjusting Sound Quality, etc.	28
Supplementary Information for Player Functions	29
Advanced Settings	30
Firmware Update	33
Troubleshooting	35
General Specifications	38
License and Trademark Information	39

What's in the box

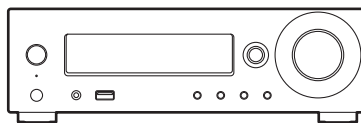

Main unit (1)

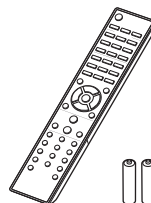

Remote controller (RC-952S) (1)
Batteries (AAA/R03) (2)



DAB/FM wire antenna (1)



Power cord (1)



- The power cord must be connected only after all other cable connections are completed.
- Connect speakers with 4 Ω to 16 Ω impedance.
- We will not accept responsibility for damage arising from the connection of equipment manufactured by other companies.
- Functionality may be introduced by firmware updates and service providers may cease services, meaning that some network services and content may become unavailable in the future.
- Specifications and appearance are subject to change without prior notice.

Front Panel

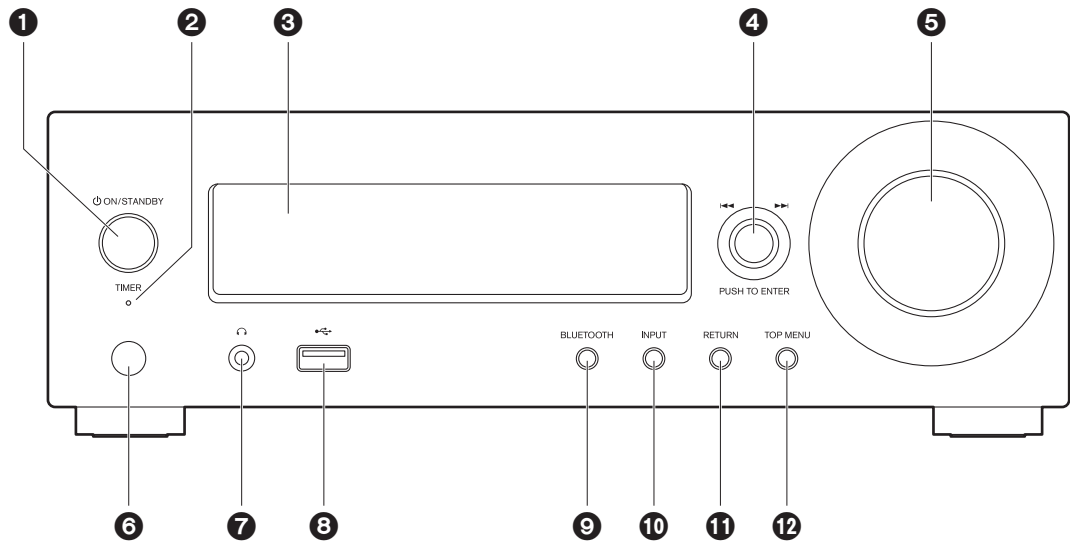

1. **ON/STANDBY button** : Turns the unit on or to standby mode.
2. **TIMER indicator** : This lights when the alarm is set.
3. **Display** (→P9)
4. **PUSH TO ENTER dial** (◀◀/▶▶) :
When playing, turn left or right to select the folder or file, then press to confirm.
While the menu is displayed, turn the dial to select items and press to confirm the settings.
 - Depending on the input, the operation may not start.
5. **VOLUME dial** : Adjust the volume. Adjust between 0 and 50.
6. **Remote control sensor**
7. **Headphone jack** : Connect stereo headphones with a mini plug.
8. **USB port** : Connect a USB storage device or HDD (hard disk drive) to play music files. You can also supply power (maximum 5 V/0.5 A) to USB devices with a USB cable.
 - When connecting a HDD that requires more than 5 V/0.5 A, connect to the USB port on the rear of the unit (maximum 5 V/1 A).
9. **BLUETOOTH button** : Switch to BLUETOOTH input.
10. **INPUT button** : Switches the input to be played.
11. **RETURN button** : Returns the display to the previous state.
12. **TOP MENU button** : Displays the settings menu.

Rear Panel

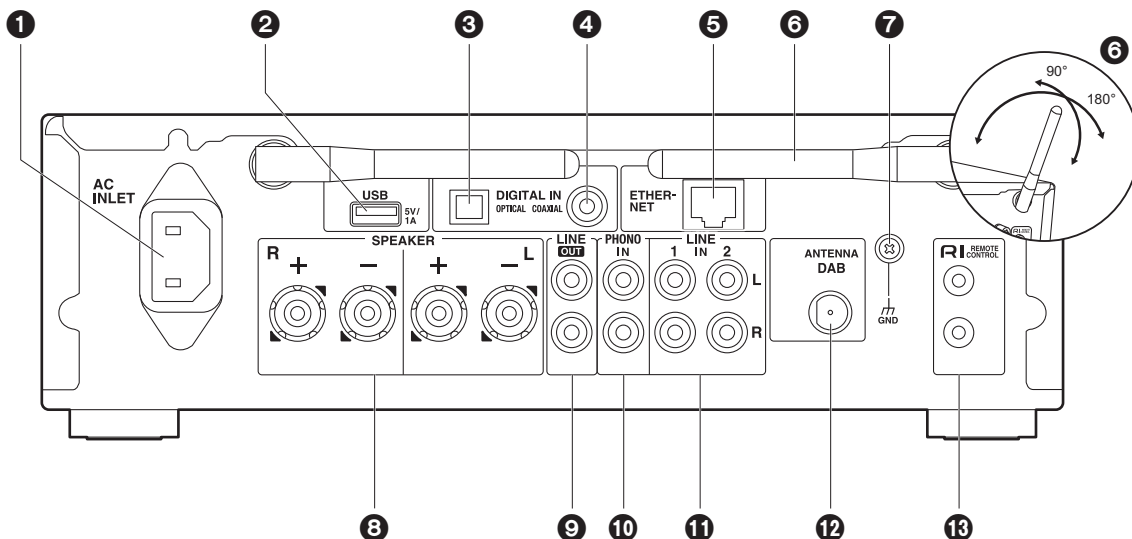

1. AC INLET : Connect the supplied power cord.
2. USB port: Connect a USB storage device or HDD (hard disk drive) to play music files. You can also supply power (maximum 5 V/1 A) to USB devices with a USB cable.
3. DIGITAL IN OPTICAL terminal : Input digital audio signals from an external device, such as a TV or CD player, with a digital optical cable.
4. DIGITAL IN COAXIAL terminal : Input digital audio signals from an external device, such as a TV or CD player, with a digital coaxial cable.
5. ETHERNET port : Connect to the network with an Ethernet cable.
6. Wireless antenna : Used for Wi-Fi connection or when using a BLUETOOTH enabled device. Adjust their angles according to the connection status.
7. GND terminal : Connect if the turntable connected to the PHONO IN jack has a ground wire.
8. SPEAKER terminals : Connect speakers with speaker cables.
9. LINE OUT jacks : Connect a recording device such as a cassette tape deck with an analog audio cable. You can also connect a subwoofer with built-in amplifier with a subwoofer cable. (→P10, 32 "LINE OUT/SW")
10. PHONO IN jacks : Connect a turntable (MM cartridge).
11. LINE IN jacks : Input audio signals from an external device, such as a TV or CD player, with an analog audio cable.
12. ANTENNA DAB terminal : Connect the supplied DAB/ FM wire antenna.
13. RI REMOTE CONTROL jacks : Connect an Onkyo product with an RI jack using an RI cable to synchronize with this unit. (→P24)

Remote Controller

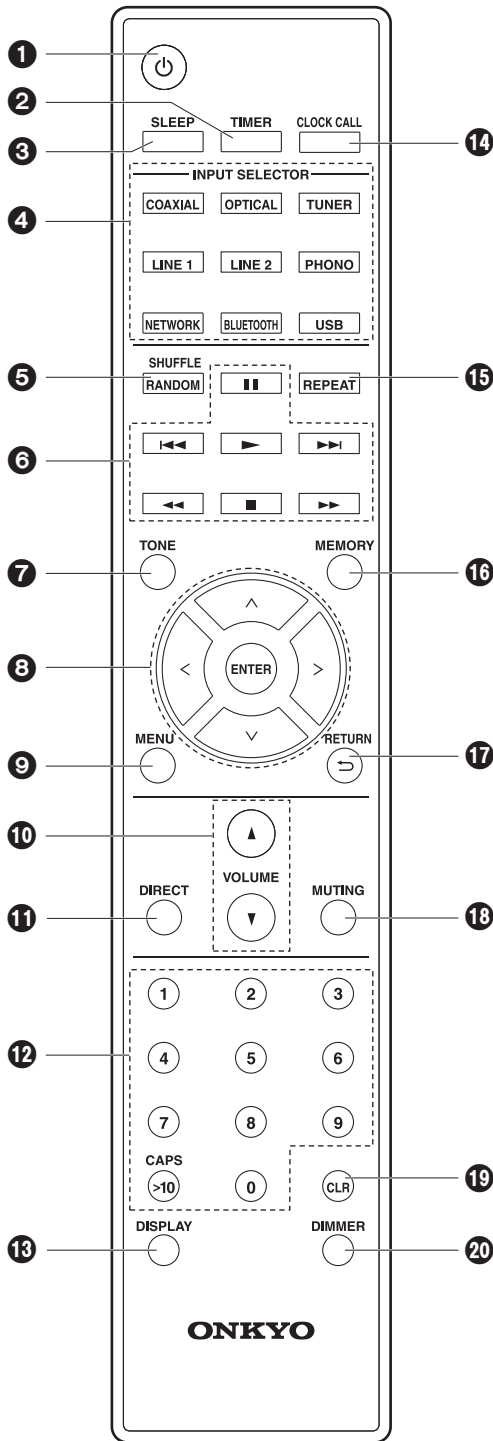

1. button : Turns the unit on or into standby mode.
2. TIMER button : Used to set the alarm.
3. SLEEP button : Set the sleep timer. When the time set (30, 60, or 90 minutes) has elapsed, the unit switches to standby. If SLEEP button is pressed after setting, the time remaining until sleep is displayed.
4. INPUT SELECTOR button : Switches the input to be played.
5. SHUFFLE/RANDOM button : Set shuffle play.
6. Play buttons:
 - ▶ : Start play.
 - || : Pause play.
 - : Stop playback.
 - ◀◀ : Move to the track before the one being played.
 - ▶▶ : Move to the next track.
 - ◀◀ and ▶▶ are not used.
 - Depending on the input, the operation may not start.
7. TONE button : Adjust the sound quality.
8. Cursors, ENTER button : Select the item with the cursors and press ENTER to confirm.
9. MENU button : Displays the setup menu.
10. VOLUME button : Adjust the volume. Adjust between 0 and 50.
11. DIRECT button : This enables the Direct function that shuts down processing that affects sound quality so sound closer to the original is reproduced. Press again to cancel.
12. Number buttons : Use to directly input the frequency of stations when tuning.
13. DISPLAY button : Switches the information on the display.
14. CLOCK CALL button : Used to set the time.
15. REPEAT button : Set repeat play.
16. MEMORY button : Used to register favorite radio stations.
17. RETURN () button : Returns the display to the previous state.
18. MUTING button : Temporarily mutes audio. Press again to cancel muting.
19. CLR button : Used when entering text, etc.
20. DIMMER button : Adjust the brightness of the display in three steps.

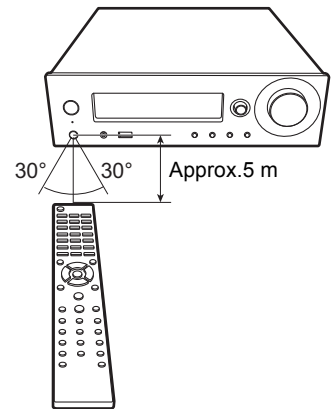

Display

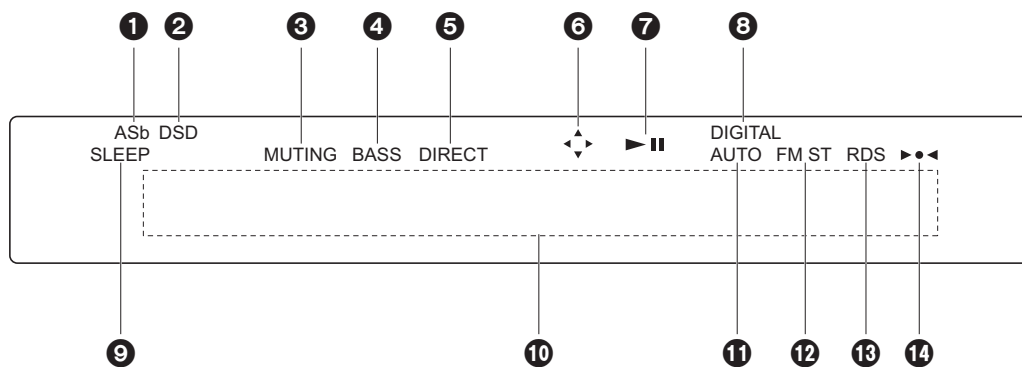

1. Lights when "Auto Standby" (➔P30) is set to "On".
2. Lights when the audio signal being input is DSD.
3. Flashes when muting is on.
4. Lights when "PM Bass" (➔P28) is "On" to emphasized the bass.
5. Lights when the Direct function, which shuts down processing that affects sound quality so sound closer to the original is reproduced, is enabled.
6. Lights when remote controller cursor operations are possible in screens showing list of tracks, for example.
7. Displays the play status.
8. Lights when digital signals are input and the digital input is selected.
9. Lights when the sleep timer is set.
10. Message display : Displays information about tracks and menus.
 - Characters that cannot be displayed on this unit are replaced with asterisks (*).
 - The following icons are displayed.
 - ☐ : Folder
 - 🎵 : Track title
 - ▶ : Playing
 - ⏸ : Paused
 - 👤 : Artist
 - 📀 : Album
 - 🔁 : 1-track repeat
 - 📁 : Repeat within a folder
 - 🔀 : Shuffle
11. Lights when automatic tuning is selected as the method for tuning radio stations.
12. Lights when FM stereo is being received.
13. Lights when RDS information is being received.
14. Lights when tuned into a radio station.

Connect the Speakers

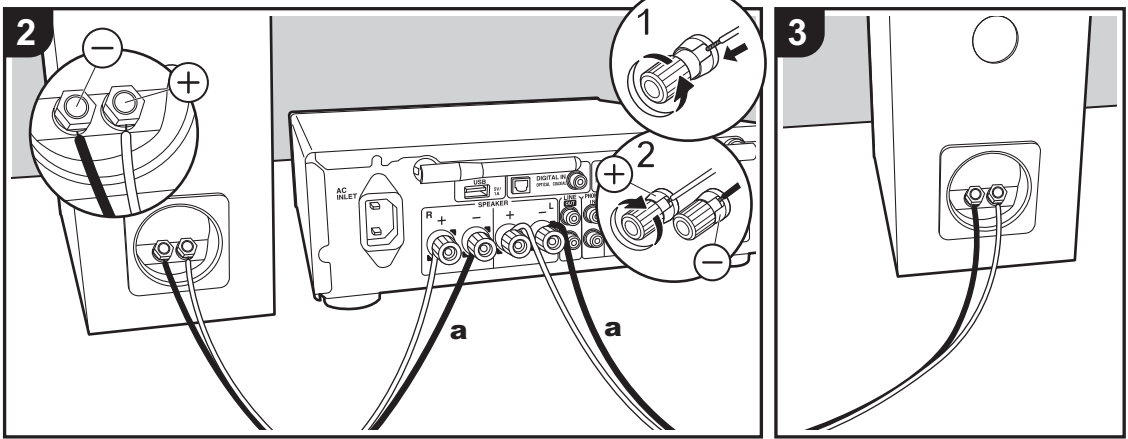
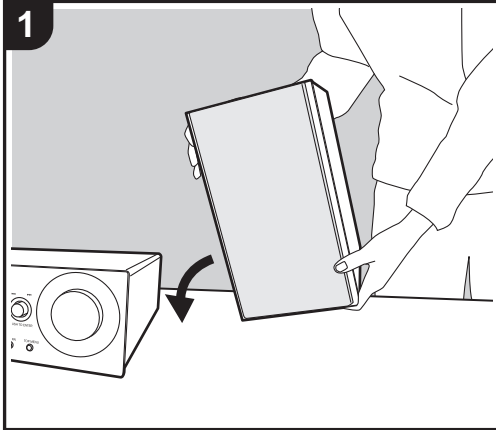

a Speaker cable

Refer to the illustration to connect your own speakers. After inserting the speaker cables, tighten the terminals firmly by turning to the right.

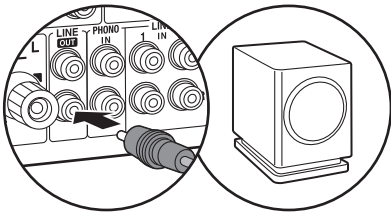

You can also connect a subwoofer with a built-in amplifier to boost bass playback even more. When connecting, make sure you connect to the Rch of the LINE OUT jacks using a subwoofer cable. Settings need to be changed when connecting a subwoofer. (→P32 "LINE OUT/SW")

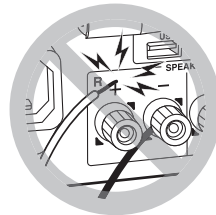

Also make sure the exposed wires of the speakers do not stick out of the speaker terminals when connecting. If the exposed wires of the speakers touch the rear panel or the + and - wires touch each other, the protection circuit may be activated and the power may turn off.

Connecting the Antennas and Power Cord, etc.

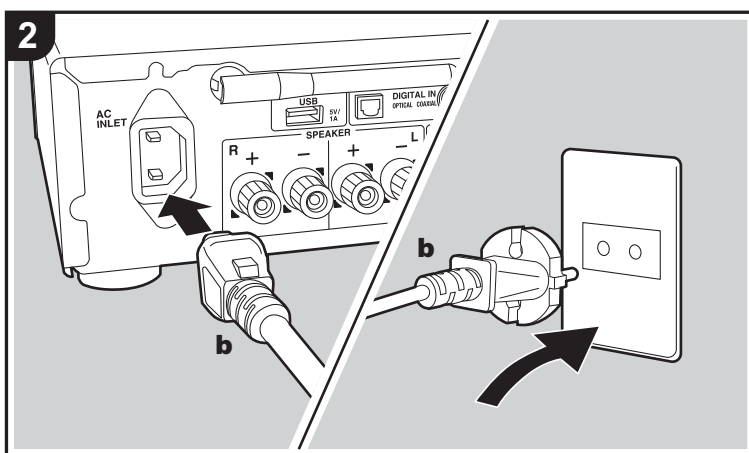
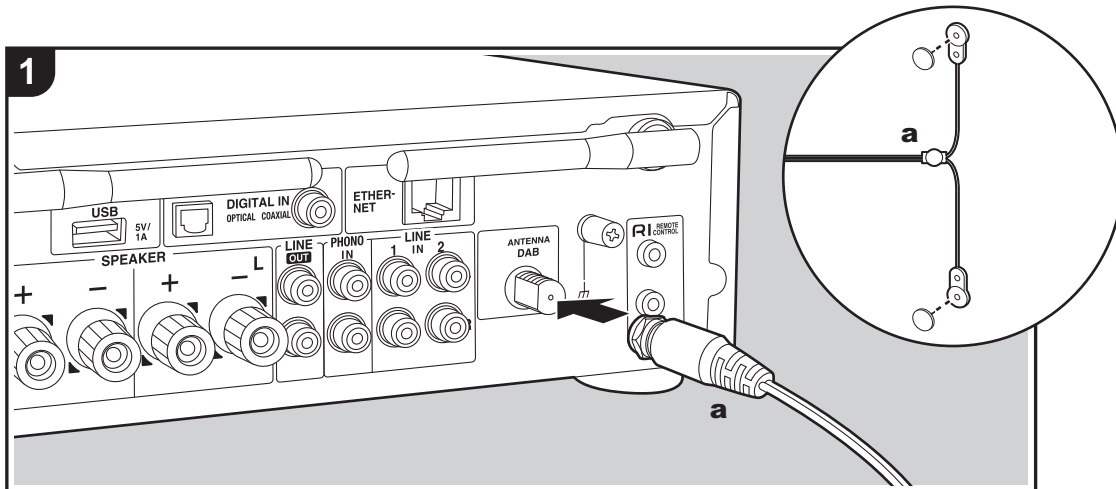

a DAB/FM wire antenna, **b** Power cord

Antenna Hookup

Move the antenna around while playing the radio to find the position with the best reception.

Power Cord Hookup

Connect the power cord to the power outlet after completing all other connections.

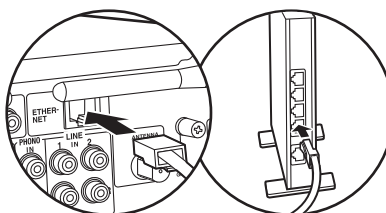

To connect to the network with a Ethernet cable, use the ETHERNET jack. When using Wi-Fi connection, make settings in initial settings (→ P12). You can enjoy features such as internet radio and AirPlay by connecting to the network.

Power On & Initial Setup

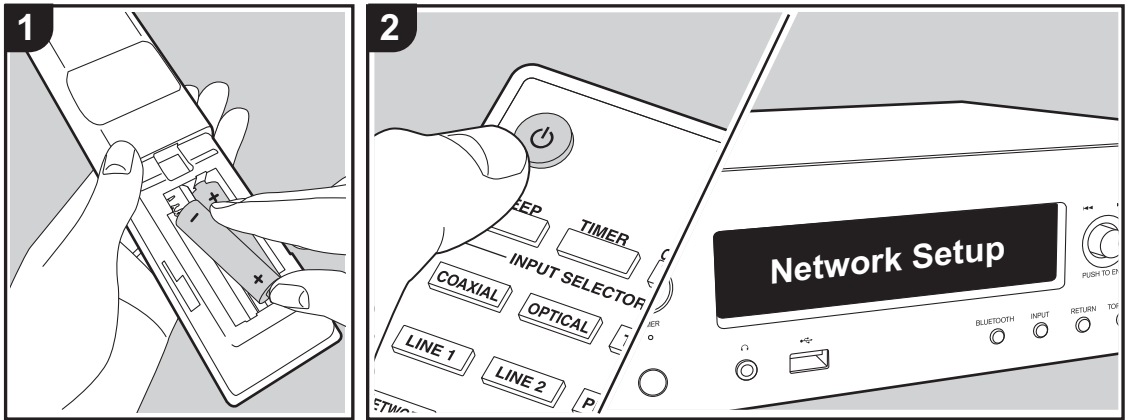

Wi-Fi connection settings

When you first turn the power on, the initial setup screen is displayed automatically, allowing you to easily make Wi-Fi connection settings.



To set, select the item with the cursors (a) on the remote controller and press ENTER (b) to confirm. To return to the previous display, press \leftarrow (c).

- Turn PUSH TO ENTER on the main unit to the left and right to select the item, then press the dial to confirm.
- If you want to use the unit without setting up a network, or want to set up the network at a later time, press \leftarrow (c) on the remote controller while "Network Setup" is displayed.

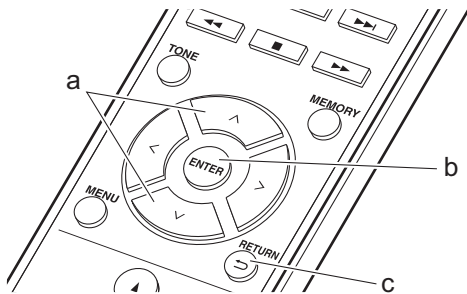

1. Press ENTER (b) when "Network Setup" is displayed.
2. To make Wi-Fi settings, select "Wi-Fi". If you have connected with an ethernet cable, select "Wired(Exit)" with \wedge/\vee (a) on the remote controller and press ENTER (b).

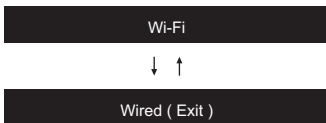

3. If you selected "Wi-Fi", select the setting method with \wedge/\vee (a) on the remote controller and press ENTER (b).

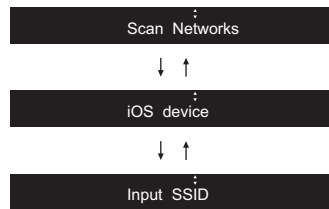

- To redo the initial settings, press MENU on the remote controller, select "Wi-Fi" in "Network" - "Connection", then select "Wi-Fi Setup".

■ Scan Networks

From the list of SSID for access points such as wireless LAN routers, select the required SSID and make the settings.

1. Select the SSID of the access point you want to connect with \wedge/\vee (a) on the remote controller and press ENTER (b).

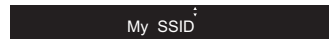

2. Select "Password" or "Push Button" with \wedge/\vee (a) on the remote controller and press ENTER (b). If the access point has an automatic connection button, by selecting "Push Button" you can connect without entering a password.



3. If you select "Password", enter the password of the access point. For details on how to enter text, refer to "Entering text" (➔P28).

If you select "Push Button", then after pressing and holding the automatic setting button on the access point for the required amount of time, press ENTER (b) on the remote controller.

4. After "Check Network" is displayed, the information of the display switches when the Wi-Fi settings are complete.
 - If "Retry" appears on the display, press ENTER (b) to retry the settings.

■ iOS device

Set by sharing the iOS device's Wi-Fi settings with this unit.

1. Connect the iOS device by Wi-Fi.
2. Select this device in the "SET UP NEW AIRPLAY SPEAKER..." item on the screen of the iOS device and select "Next".
 - This unit is displayed as "Onkyo R-N855 XXXXXX".
3. After "Check Network" is displayed on this unit, when the Wi-Fi settings are complete, the display changes. Select "Done" on the screen of the iOS device.

■ Input SSID

Set by entering the SSID of the access point you want to connect.

1. Enter the SSID. For details on how to enter text, refer to "Entering text" (➔P28).
2. Select the authentication method with \wedge/\vee (a) on the remote controller and press ENTER (b).

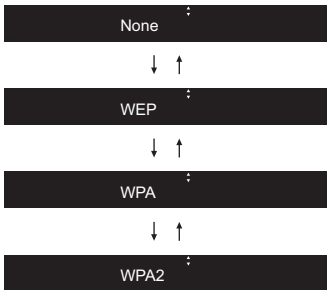

3. After "Check Network" is displayed, the information of the display switches when the Wi-Fi settings are complete.
 - If you select "None", proceed to step 3. If you select "WEP", "WPA", or "WPA2", enter the password.
3. After "Check Network" is displayed, the information of the display switches when the Wi-Fi settings are complete.
 - If "Retry" appears on the display, press ENTER (b) to retry the settings.

Time Settings

By setting the time, you can use the alarm to start play (➔P27).

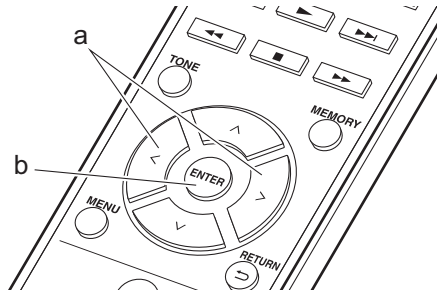

1. Press CLOCK CALL.

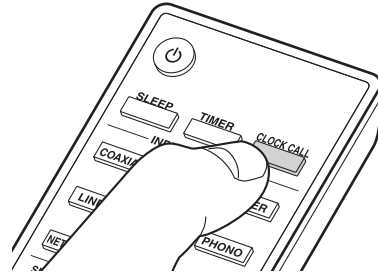

2. Press ENTER (b).
3. Set the day of the week with $</>$ (a), then press ENTER (b).
4. Use $</>$ (a) to select either "24H" (24-hour display) or "12H" (12-hour display) and press ENTER (b).
5. Set the time with $</>$ (a), then press ENTER (b).
6. Set the minutes with $</>$ (a), then press ENTER (b). Setting ends automatically after a short time.
 - Once you have completed the setting, the set time can be displayed for about 10 seconds by pressing CLOCK CALL.

USB Storage Device/HDD Playback

Basic operations

You can play music files by connecting a USB storage device or HDD (hard disk drive) to the USB port on the front or rear of the unit.

- The USB port on the front supports a maximum 5 V/ 0.5 A power supply. If the HDD requires more than this, connect to the USB port on the rear of the unit (maximum 5 V/1 A).

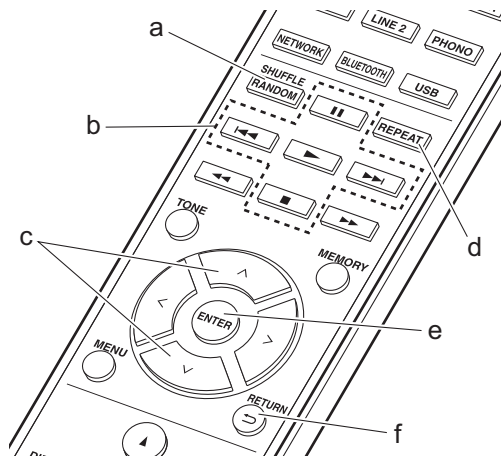

1. Turn the unit on.
2. Press USB to select "USB (F)" (USB port on the front panel) or "USB (R)" (USB port on the rear panel).

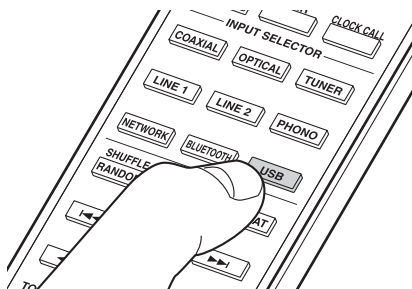

3. Plug your USB storage device or HDD into the USB port on the front or rear.

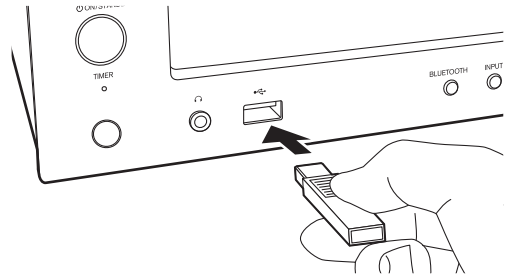

OR

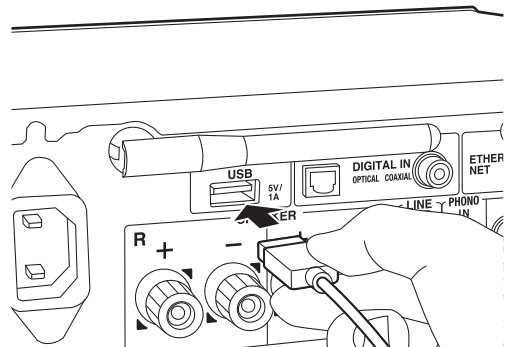

4. Press ENTER (e) after reading is complete.
5. Select the folder or music file with ^/∨ (c) on the remote controller and press ENTER (e). To return to the previous display, press ↵ (f).
6. Use play buttons (b) to stop play or choose tracks to play.
 - The display of album name and artist name is supported with MP3/WMA/Apple Lossless/FLAC/AAC/DSD (DSF only) format music files.
 - Characters that cannot be displayed by this unit appear as "*".
 - The USB port of this unit conforms with the USB 2.0 standard. The transfer speed may be insufficient for some content you play, which may cause some interruption in sound.

Repeat play

1. Repeatedly press REPEAT (d) during play to display
 - ▶ : Repeat play of the selected individual track.
 - ◻ : Repeat play of all tracks within a folder.
 To cancel repeat play, press REPEAT (d) several times until the icons disappear.

Shuffle Play

1. Press SHUFFLE/RANDOM (a) during play to display
 - ⌘ : Play tracks in a folder randomly.
 To cancel shuffle play, press SHUFFLE/RANDOM (a) to disappear the icon.

USB Storage / HDD Device Requirements

- Note that operation is not guaranteed with all USB storage devices or HDD.
- This unit can use USB storage devices that comply with the USB mass storage device class standard. (However, there are still devices that cannot be played by this unit even if they comply with the USB mass storage class standard.)
- The unit is also compatible with USB storage devices using the FAT16 or FAT32 file system formats. Other formats such as exFAT, NTFS, and HFS cannot be played by this unit.
- If the USB storage device has been partitioned, each section will be treated as an independent device.
- Up to 20,000 tracks per folder can be displayed, and folders may be nested up to 16 levels deep.
- USB hubs and USB storage devices with hub functions are not supported. Do not connect these devices to the unit.
- USB storage devices with security function are not supported on this unit.
- If the USB storage device or HDD comes with an AC adapter, we recommend that you use its AC adapter to power it.
- Media inserted to the USB card reader may not be available in this function. Furthermore, depending on the USB storage device, proper reading of the contents may not be possible.
- We accept no responsibility whatsoever for the loss or damage to data stored on a USB storage device when that device is used with this unit. We recommend that you back up your important music files beforehand.

Supported Audio Formats

This unit supports the following music file formats. Note that sound files that are protected by copyright cannot be played on this unit.

MP3 (.mp3/.MP3) :

- Supported formats : MPEG-1/MPEG-2 Audio Layer-3
- Supported sampling rates : 44.1 kHz, 48 kHz
- Supported bitrates : Between 8 kbps and 320 kbps and VBR.

WMA (.wma/.WMA) :

- Supported sampling rates : 44.1 kHz, 48 kHz
- Supported bitrates : 5 kbps and 320 kbps and VBR.
- WMA Pro/Voice/WMA Lossless formats are not supported

WAV (.wav/.WAV) :

WAV files include uncompressed PCM digital audio.

- Supported sampling rates : 44.1 kHz, 48 kHz, 88.2 kHz, 96 kHz, 176.4 kHz, 192 kHz
- Quantization bit : 8 bit, 16 bit, 24 bit

AIFF (.aiff/.aif/.aifc/.afc/.AIFF/.AIF/.AIFC/.AFC) :

AIFF files include uncompressed PCM digital audio.

- Supported sampling rates : 44.1 kHz, 48 kHz, 88.2 kHz, 96 kHz, 176.4 kHz, 192 kHz
- Quantization bit : 8 bit, 16 bit, 24 bit

AAC (.aac/.m4a/.mp4/.3gp/.3g2/.AAC/.M4A/.MP4/.3GP/.3G2) :

- Supported formats : MPEG-2/MPEG-4 Audio
- Supported sampling rates : 44.1 kHz, 48 kHz, 88.2 kHz, 96 kHz
- Supported bitrates : Between 8 kbps and 320 kbps and VBR.

FLAC (.flac/.FLAC) :

- Supported sampling rates : 44.1 kHz, 48 kHz, 88.2 kHz, 96 kHz, 176.4 kHz, 192 kHz
- Quantization bit : 8 bit, 16 bit, 24 bit

Apple Lossless (.m4a/.mp4/.M4A/.MP4) :

- Supported sampling rates : 44.1 kHz, 48 kHz, 88.2 kHz, 96 kHz, 176.4 kHz, 192 kHz
- Quantization bit : 16 bit, 24 bit

DSD (.dsf/.dff/.DSF/.DFF) :

- Supported formats : DSF/DSDIFF
- Supported sampling rates : 2.8 MHz, 5.6 MHz, 11.2 MHz

Internet Radio

Basic operations

When this unit is connected to a network, you can listen to TuneIn or other preregistered Internet radio services.

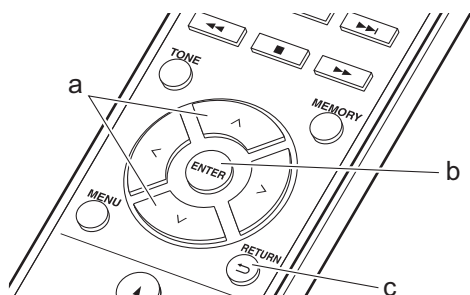

1. Turn the unit on.
2. Press NETWORK.

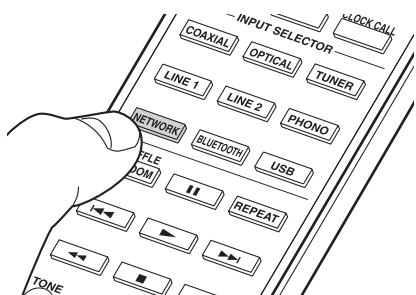

3. Select "TuneIn Radio" with \wedge/\vee (a) on the remote controller and press ENTER (b).



- If "Connection Error." is displayed, check whether the network is properly connected.
4. Select stations with \wedge/\vee (a) on the remote controller and press ENTER (b). To return to the previous display, press \leftarrow (c).

The TuneIn My Presets function :

You can register a station you have played as a favorite.

1. Press ENTER (b) while playing TuneIn.
2. Select "Add to My Presets" with \wedge/\vee (a) on the remote controller and press ENTER (b).
3. To play a favorite, select a registered station in "My Presets", displayed first when "TuneIn Radio" selected and press ENTER (b). To delete favorites, press ENTER (b) during play, select "Remove from My Presets" and press ENTER (b).

Spotify

Spotify Connect play is possible by connecting this unit to the same network as a smartphone or tablet. To enable Spotify Connect, install the Spotify application on your smartphone or tablet and create a Spotify premium account.

1. Connect the smartphone to the network that this unit is connected to.

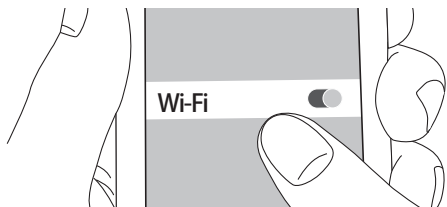

2. Click the Connect icon in the track play screen of the Spotify app.

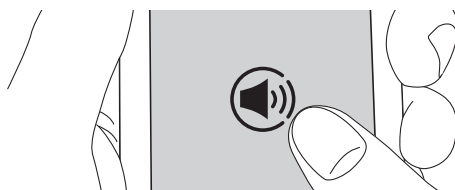
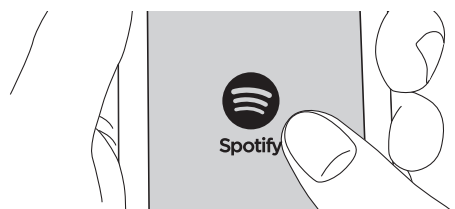

3. Select this unit.

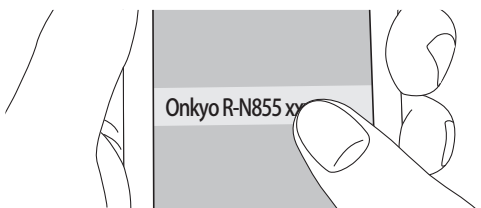

- This unit is displayed as "Onkyo R-N855 XXXXXX".
4. This unit turns on automatically and the input selector changes to NET and streaming of Spotify starts.
 - If "Option" - "PWR Setting" - "NET Stby" is set to "Off" in the setup menu, manually turn the unit on and then press NETWORK on the remote controller.
 - Refer to the following for Spotify settings:
www.spotify.com/connect/
 - The Spotify software is subject to third party licenses found here:
www.spotify.com/connect/third-party-licenses

The following remote controller operations are also possible.

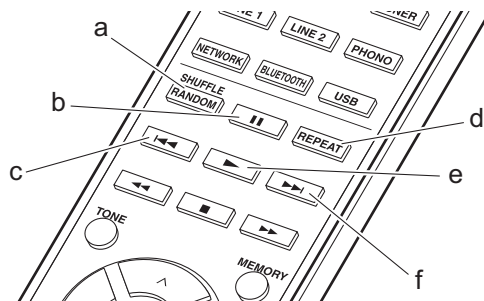

- (a) Start shuffle play.
- (b) Pause play.
- (c) Play the previous track.
- (d) Start repeat play.
- (e) Start play.
- (f) Play the next track.

Listening to the FM/DAB Radio

Listening to FM Radio

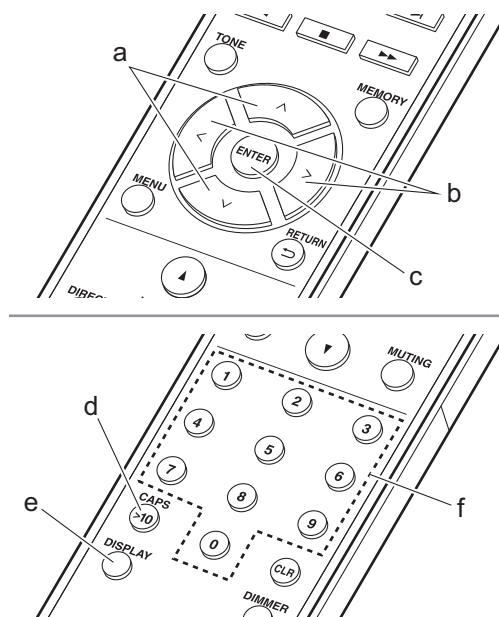

Tuning Automatically

1. Turn the unit on.
2. Repeatedly press TUNER to switch input to FM.

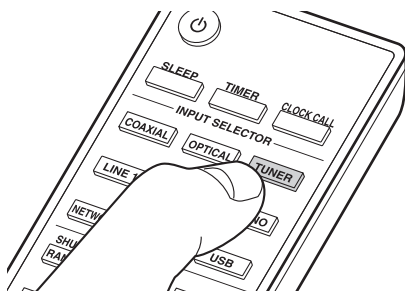

FM 87.50MHz

3. When you press \wedge/\vee (a) on the remote controller, automatic tuning starts, and searching stops when a station is found. "FM ST" indicator on the display lights when FM stereo station is being received.

When FM broadcasts are difficult to receive : Perform the procedure for "Tuning Manually". If you tune manually, the reception for FM broadcasts will be monaural rather than stereo, irrespective of the sensitivity of the reception.

Tuning Manually

1. Turn the unit on.
2. Repeatedly press TUNER to switch input to FM.

FM 87.50MHz

3. Press ENTER (c) on the remote controller so that the "AUTO" indicator on the display goes off.

4. Select the station you want to listen to while pressing \wedge/\vee (a) on the remote controller.
 - The frequency changes by 1 step each time you press the button. The frequency changes continuously if the button is held down and stops when the button is released. Tune by looking at the display.
 - After pressing PUSH TO ENTER on the main unit until the frequency display flashes, you can turn the dial left or right to tune stations.

Directly inputting the frequency

It allows you to directly enter the frequency of the radio station you want to listen to.

1. Turn the unit on.
2. Repeatedly press TUNER to switch input to FM.
3. Press CAPS (d) on the remote controller.
4. Press the number buttons (f) on the remote controller to enter the frequency of the radio station within 8 seconds.
 - To enter 87.50, for example, press 8, 7, 5, 0. If you enter the wrong number, press CAPS (d) and re-enter.

Using RDS

RDS stands for Radio Data System and is a method of transmitting data in FM radio signals. In regions using RDS, the radio station name is displayed when you tune into a radio station broadcasting program information. When you press DISPLAY (e) on the remote controller in this state, you can use the following functions.

Displaying text information (Radio Text):

1. While the name of the station is being displayed on the display, press DISPLAY (e) on the remote controller once.

Radio Text (RT) broadcast by the station is displayed scrolling across the display. "No Text Data" is displayed when no text information is available.

 - Unusual characters may be displayed when the unit receives unsupported characters. However, this is not a malfunction. Also, if the signal from a station is weak, information may not be displayed.

Search for stations by Program Type:

1. While the name of the station is being displayed on the display, press DISPLAY (e) on the remote controller twice.
2. Press \langle / \rangle (b) on the remote controller to select the Program Type you want to find, then press ENTER (c) to start the search.

The Program Types displayed are as follows:

 - None
 - News (News reports)
 - Affairs (Current affairs)
 - Info (Information)
 - Sport
 - Educate (Education)
 - Drama
 - Culture
 - Science (Science and technology)
 - Varied
 - Pop M (Pop music)
 - Rock M (Rock music)
 - Easy M (Middle of the road music)
 - Light M (Light classics)

- Classics (Serious classics)
- Other M (Other music)
- Weather
- Finance
- Children (Children's programmes)
- Social (Social affairs)
- Religion
- Phone In
- Travel
- Leisure
- Jazz (Jazz music)
- Country (Country music)
- Nation M (National music)
- Oldies (Oldies music)
- Folk M (Folk music)
- Document (Documentary)

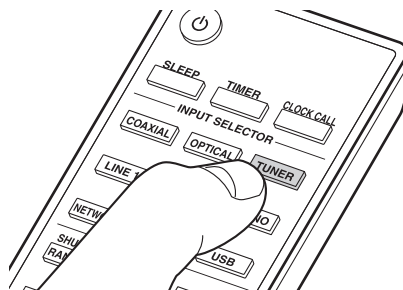

- The information displayed may sometimes not match the content being broadcast by the station.
3. When a station is found, the station flashes on the display. Press ENTER (c) while this is happening to start receiving that station. If you don't press ENTER (c), the unit continues to search for another station.
 - If no stations are found, the message "Not Found" is displayed.
 - Unusual characters may be displayed when the unit receives unsupported characters. However, this is not a malfunction. Also, if the signal from a station is weak, information may not be displayed.

- The very first time you select DAB, the Auto Tuning function automatically scans the DAB Band 3 for the multiplexes (i.e., stations) available in your area.



- Once the scanning process is complete, the first station that was detected is selected.
 - If a new DAB station is introduced, or you move to a new area, press MENU (b) on the remote controller, then use "DAB Scan" in "Option" - "Tuner Setting".
3. Press ^/∨ (a) on the remote controller to select the desired radio station.

Listening to DAB Digital Radio

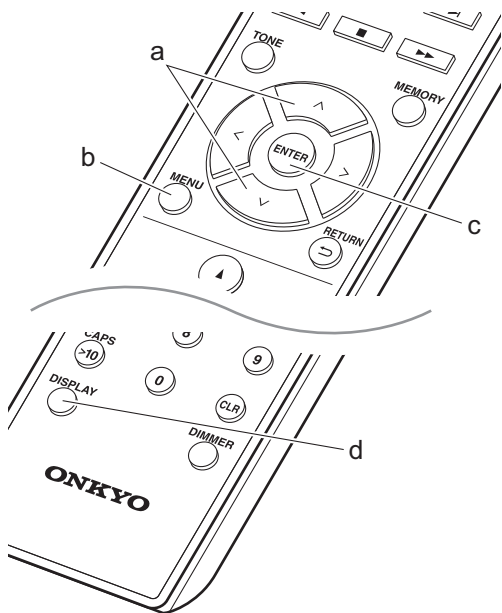

Tuning

1. Turn the unit on.
2. Repeatedly press TUNER to switch input to DAB.

Changing the order stations are displayed

You can sort the available stations alphabetically or by multiplex.

1. Press ENTER (c) repeatedly to set the method for sorting the display order from the following.

Alphabet (default setting) : Sort stations alphabetically.

Multiplex : Sort stations by multiplex.

Displaying DAB Radio Information

1. Press the DISPLAY button (d) repeatedly to display more information about the selected DAB station.

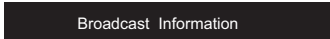

DLS (Dynamic Label Segment) : When tuned to a station that's broadcasting DLS text data, the text will scroll across the display.

Program Type : Displays the type of program.

Bit Rate and Audio Mode : Displays the station's bit rate and audio mode (stereo, mono).

Signal Quality : Displays the signal quality.

0 - 59: Poor reception

60 - 79: Good reception

80 - 100: Excellent reception

Multiplex Name : Displays the name of the current multiplex.

Multiplex Number and Frequency : Displays the number and frequency of the current multiplex.

Registering a station

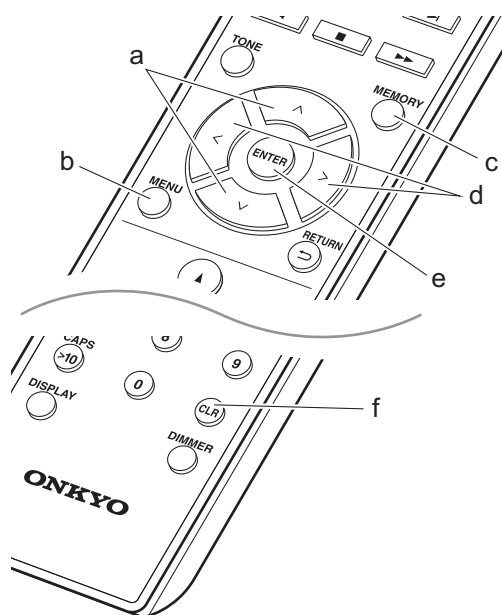

To give a name to a registered station (FM stations only) :

1. Press TUNER.
2. Press </> (d) on the remote controller to select a preset number.
3. Press MENU (b) on the remote controller.
4. Press ^/∨ (a) on the remote controller to select "Option" - "Tuner Setting" - "NameEdit" and press ENTER (e).
5. Enter a name for the station. For details on how to enter text, refer to "Entering text" (➔P28).

You can register a maximum of 40 radio stations, the sum of FM stations and DAB stations.

1. Tune into the radio station you want to register.
2. Press MEMORY (c) on the remote controller so that the preset number on the display flashes.



3. While the preset number is flashing (about 8 seconds), repeatedly press </> (d) on the remote controller to select a number between 1 and 40.
4. Press MEMORY (c) on the remote controller again to register the station. When registered, the preset number stops flashing.

Selecting registered stations

1. Press TUNER.

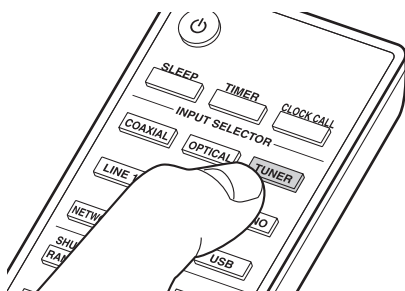

2. Press </> (d) on the remote controller to select a preset number.

To delete a registered station :

1. Press TUNER.
2. Press </> (d) on the remote controller to select the preset number you want to delete.
3. Press CLR (f) on the remote controller to delete the preset number.

BLUETOOTH®

Pairing

1. Turn the unit on.
2. When you press BLUETOOTH, "Now Pairing..." is displayed on the display, and the pairing mode is enabled.

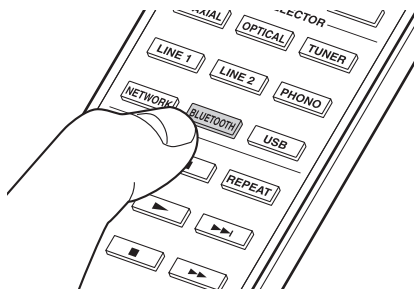

Now Pairing...

3. Enable (turn on) the BLUETOOTH function of the BLUETOOTH enabled device, then select this unit from amongst the devices displayed. If a password is requested, enter "0000".

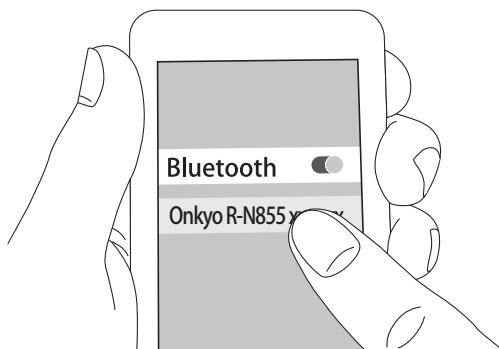

4. "Now Pairing..." on the display changes to the name of the BLUETOOTH enabled device.
- This unit is displayed as "Onkyo R-N855 XXXXX".
 - To connect another BLUETOOTH enabled device, press and hold BLUETOOTH until "Now Pairing..." is displayed, then perform step 3 above. This unit can store the data of up to eight paired devices.
 - The coverage area is 15 meters. Note that connection is not always guaranteed with all BLUETOOTH enabled devices.

Playing back

1. Turn the unit on.
2. Perform the connection procedure on the BLUETOOTH enabled device.

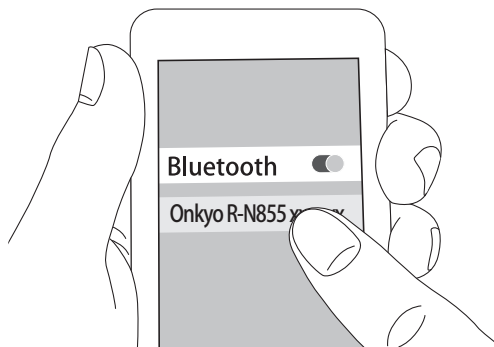

3. The input selector on this unit automatically switches to "BLUETOOTH".
4. Play the music files. Increase the volume of the BLUETOOTH enabled device to an appropriate level.

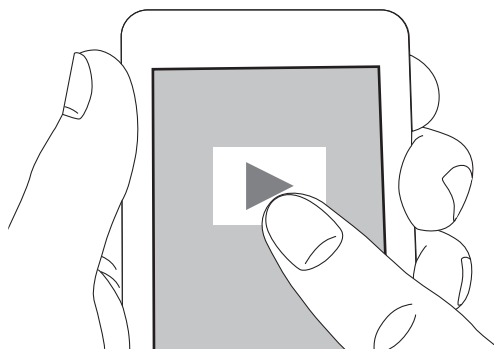



- Due to the characteristics of BLUETOOTH wireless technology, the sound produced on this unit may slightly be behind the sound played on the BLUETOOTH enabled device.

Basic operations

You can wirelessly enjoy the music files on an iPhone®, iPod touch®, or iPad® connected to the same access point as this unit. Update the OS version on your iOS device to the latest version.

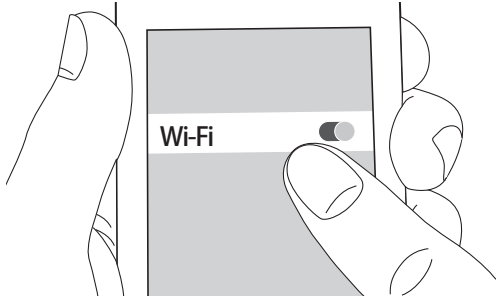
1. Turn the unit on.
2. Connect the iOS device to the same network as this unit.



3. Tap the AirPlay icon  in the control center of the iOS device and select this unit from the list of devices displayed, and tap "Done".

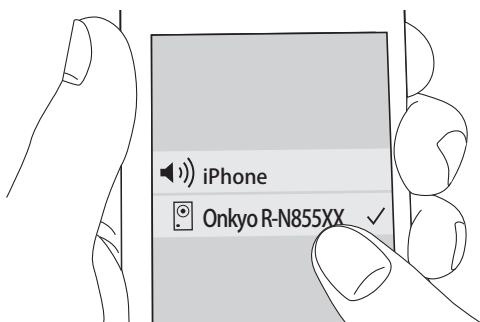
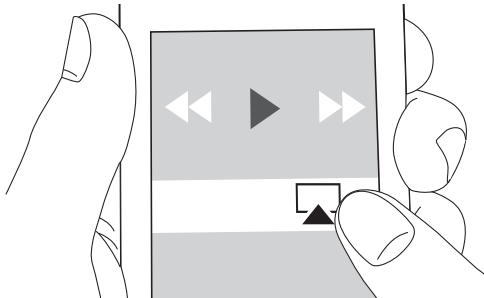

- This unit is displayed as "Onkyo R-N855 XXXXXX".
- If an "AirPlay PW" has been set on this unit, enter the password you set.

4. Play the music files on the iOS device.

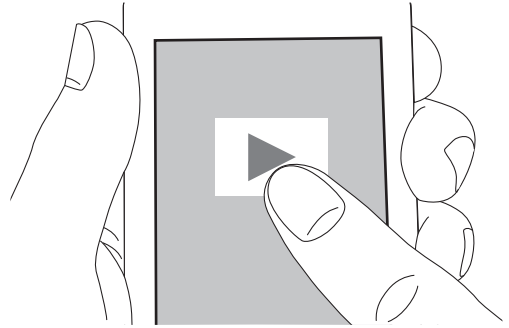

- In the setup menu displayed by pressing MENU on the remote controller, when "Option" - "PWR Setting" - "NET Stby" is set to "On", when play of AirPlay starts, this unit turns on automatically and play starts.
- Due to the characteristics of AirPlay wireless technology, the sound produced on this unit may slightly be behind the sound played on the AirPlay-enabled device.
- SHUFFLE/RANDOM and REPEAT on the remote controller does not work. Operate from the iOS device.

You can also play the music files on a computer with iTunes (Ver. 10.2.2 or later). Make sure this unit and the computer are connected to the same network, click the AirPlay icon  in iTunes, select this unit from the list of devices displayed, and start play of a music file.

Playing Audio from an External Device

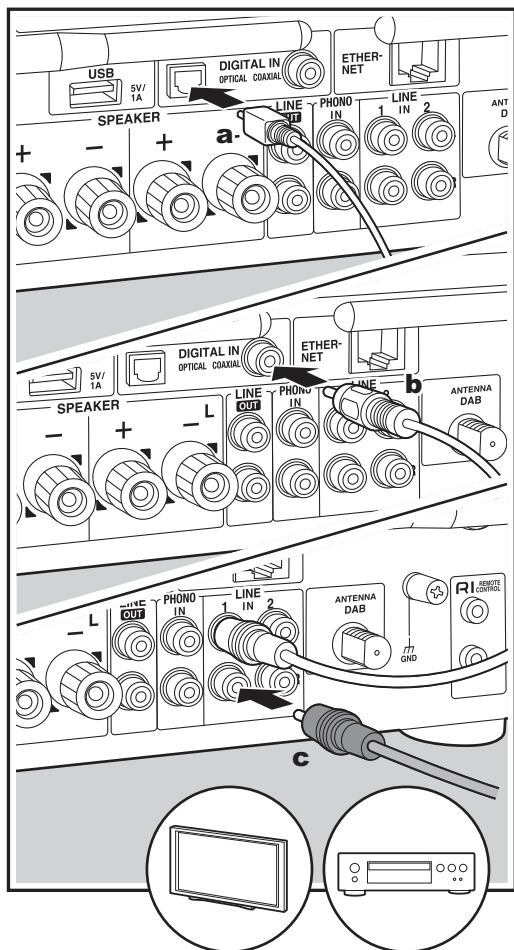

a Digital optical cable, **b** Digital coaxial cable, **c** Analog audio cable

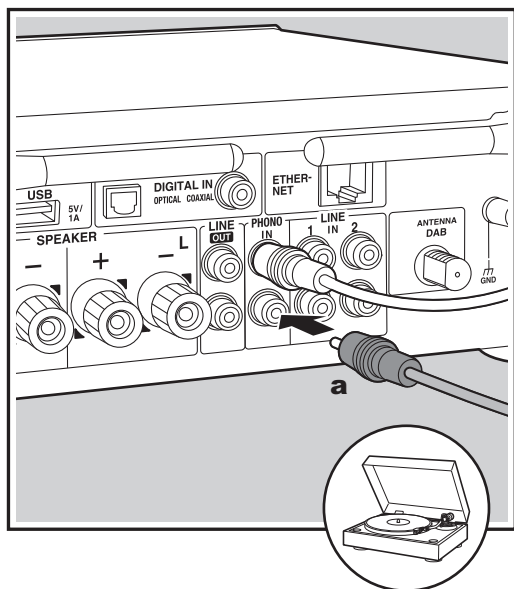

a Analog audio cable

Connections

You can play the audio from external devices such as TVs, CD players, and turntables with MM cartridges through this unit. Connect as follows according to the output jacks on the external devices you are connecting. When using a digital optical cable, connect to the DIGITAL IN OPTICAL terminal on this unit. When using a digital coaxial cable, connect to the DIGITAL IN COAXIAL terminal on this unit. When connecting with an analog audio cable, connect the turntable to the PHONO IN jack and other external devices is to the LINE IN jacks on this unit.

- If the connected turntable has a built-in audio equalizer, connect it to the LINE IN jack.
- If the turntable has a ground wire, connect it to the GND terminal.

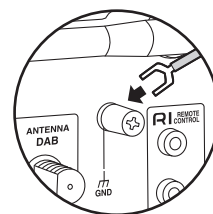

Playing Back

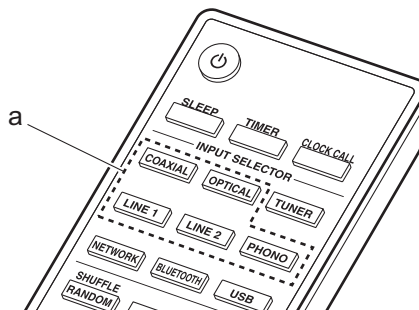

1. Turn the unit on.
2. Press OPTICAL, COAXIAL, LINE 1, LINE 2, or PHONO (a) to match the terminal you have connected the device to switch the input of this unit.

OPTICAL

3. Start play on the player.
 - When connected by a digital optical cable or a digital coaxial cable, this unit supports linear PCM signals of up to 192 kHz/24 bits for input.

Connecting with Onkyo RI Components

By connecting an Onkyo component with RI jack to the unit by using an RI cable and an analog audio cable, you can link the unit's power and input selection and enable operation with this unit's remote controller. For details, refer to the instruction manual of the component with the RI jack.

- When connecting an Onkyo CD player or MD deck, you need to change the name of the input selector. (➔P31 "Selector Name")

Change the name of the jack to which the external device is connected, "COAXIAL", "OPTICAL", etc., to suit the device you have connected, either "CD" or "MD".

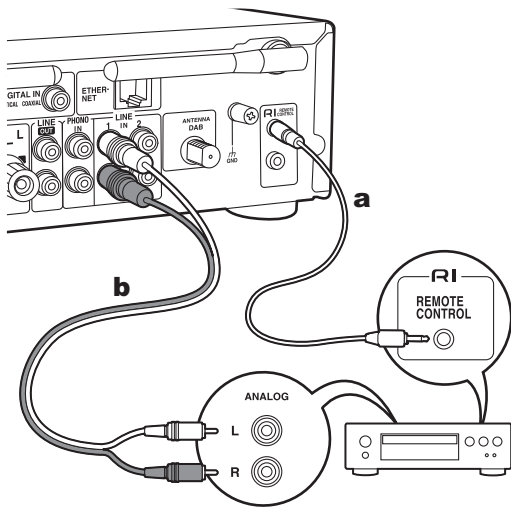

a RI cable, **b** Analog audio cable

- If there are two RI connectors, the function of the two connectors is the same. Both connectors can be used.
- Connection to RI connectors only does not work as the system. Connect also an analog audio cable correctly.
- Some components may not support all RI functions.

Music Server

It is possible to stream music files stored on PCs or NAS devices connected to the same network as this unit. The network servers this unit is compatible with are those PCs with players installed that have the server functionality of Windows Media® Player 11 or 12, or NAS that are compatible with home network functionality. You may need to make some settings in advance to use Windows Media® Player 11 or 12. Note that only music files registered in the library of Windows Media® Player can be played.

Configuring Windows Media® Player

Windows Media® Player 11

1. Turn on your PC and start Windows Media® Player 11.
2. In the “Library” menu, select “Media Sharing” to display a dialog box.
3. Select the “Share my media” check box, and then click “OK” to display the compatible devices.
4. Select this unit and click “Allow”.
 - A check mark is put to the icon for this unit.
5. Click “OK” to close the dialog.
 - Depending on the version of Windows Media® Player, there may be differences in the names of items you can select.

Windows Media® Player 12

1. Turn on your PC and start Windows Media® Player 12.
2. In the “Stream” menu, select “Turn on media streaming” to display a dialog box.
 - If media streaming is already turned on, select “More streaming options...” in the “Stream” menu to list players in the network, and then go to step 4.
3. Click “Turn on media streaming” to list players in the network.
4. Select this unit in “Media streaming options” and check that it is set to “Allow”.
5. Click “OK” to close the dialog.
 - Depending on the version of Windows Media® Player, there may be differences in the names of items you can select.

Playing Back

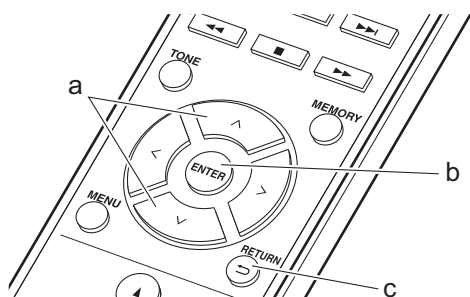

1. Turn the unit on.
2. Start the server (Windows Media® Player 11, Windows Media® Player 12, or NAS device) containing the music files to play.
3. Make sure that the PCs and/or NASs are properly connected to the same network as this unit.

4. Press NETWORK.

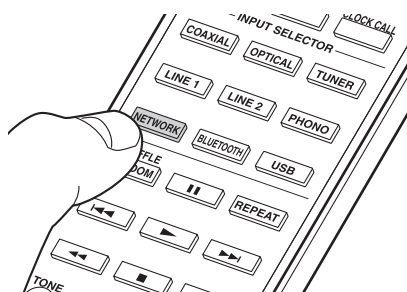

5. Press \wedge/\vee (a) on the remote controller to select “Music Server”, and then press ENTER (b).



6. Select the server and music file with \wedge/\vee (a) on the remote controller and press ENTER (b). To return to the previous display, press \leftarrow (c).
 - If “Connection Error.” is displayed, check whether the network is properly connected.
 - Depending on the server being used and the files played, elapsed play time and remaining play time may not be displayed.
 - For music files on a server, there can be up to 20,000 tracks per folder, and folders may be nested up to 16 levels deep.

Controlling Remote Playback from a PC

You can use this unit to play music files stored on your PC by operating the PC inside your home network. The unit supports remote playback with Windows Media® Player 12.

1. Turn on your PC and start Windows Media® Player 12.
2. Open the “Stream” menu and check that “Allow remote control of my Player...” is checked. Click “Turn on media streaming” to list players in the network.
3. Select and right-click the music file to play with Windows Media® Player 12. To remotely play a music file on another server, open the target server from “Other Libraries” and select the music file to play.
4. Select this unit in “Play to” to open the “Play to” window of Windows Media® Player 12 and start playback on the unit. If your PC is running on Windows® 8.1, click “Play to”, and then select this unit. If your PC is running on Windows® 10, click “Cast to Device”, and select this unit. Operations during remote playback are possible from the “Play to” window on the PC.
5. Adjust the volume using the volume bar on the “Play to” window.
 - Sometimes, the volume displayed on the remote playback window may differ from that appeared on the display of the unit. Also, when the volume is adjusted from this unit, this is not reflected in the “Play to” window.
 - Remote playback is not possible when using a network service or playing music files on a USB storage device.
 - Depending on the version of Windows Media® Player, there may be differences in the names of items you can select.

Supported Audio Formats

This unit supports the following music file formats.

- Note that playback via wireless LAN of sampling rates of 88.2 kHz or higher, and DSD are not supported.
- Remote play of FLAC, and DSD is also not supported.
- Variable bit-rate (VBR) files are supported. However, playback times may not be displayed correctly.
- Remote playback does not support the gapless playback.

MP3 (.mp3/.MP3) :

- Supported formats : MPEG-1/MPEG-2 Audio Layer-3
- Supported sampling rates : 44.1 kHz, 48 kHz
- Supported bitrates : Between 8 kbps and 320 kbps and VBR.

WMA (.wma/.WMA) :

- Supported sampling rates : 44.1 kHz, 48 kHz
- Supported bitrates : Between 8 kbps and 320 kbps and VBR.
- WMA Pro/Voice/WMA Lossless formats are not supported

WAV (.wav/.WAV) :

WAV files include uncompressed PCM digital audio.

- Supported sampling rates : 44.1 kHz, 48 kHz, 88.2 kHz, 96 kHz, 176.4 kHz, 192 kHz
- Quantization bit : 8 bit, 16 bit, 24 bit

AIFF (.aiff/.aif/.aifc/.afc/.AIFF/.AIF/.AIFC/.AFC) :

AIFF files include uncompressed PCM digital audio.

- Supported sampling rates : 44.1 kHz, 48 kHz, 88.2 kHz, 96 kHz, 176.4 kHz, 192 kHz
- Quantization bit : 8 bit, 16 bit, 24 bit

AAC (.aac/.m4a/.mp4/.3gp/.3g2/.AAC/.M4A/.MP4/.3GP/.3G2) :

- Supported formats : MPEG-2/MPEG-4 Audio
- Supported sampling rates : 44.1 kHz, 48 kHz, 88.2 kHz, 96 kHz
- Supported bitrates : Between 8 kbps and 320 kbps and VBR.

FLAC (.flac/.FLAC) :

- Supported sampling rates : 44.1 kHz, 48 kHz, 88.2 kHz, 96 kHz, 176.4 kHz, 192 kHz
- Quantization bit : 8 bit, 16 bit, 24 bit

LPCM (Linear PCM) :

- Supported sampling rates : 44.1 kHz, 48 kHz
- Quantization bit : 16 bit

Apple Lossless (.m4a/.mp4/.M4A/.MP4) :

- Supported sampling rates : 44.1 kHz, 48 kHz, 88.2 kHz, 96 kHz, 176.4 kHz, 192 kHz
- Quantization bit : 16 bit, 24 bit

DSD (.dsf/.dff/.DSF/.DFF) :

- Supported formats : DSF/DSDIFF
- Supported sampling rates : 2.8 MHz, 5.6 MHz, 11.2 MHz

Using the Alarm to Start Play

At the set time, the unit switches on and starts play of the desired source. You can set two different timers, "TIMER 1" and "TIMER 2". Make sure that the clock on this unit is set correctly. You cannot use the timers if the clock has not been set.

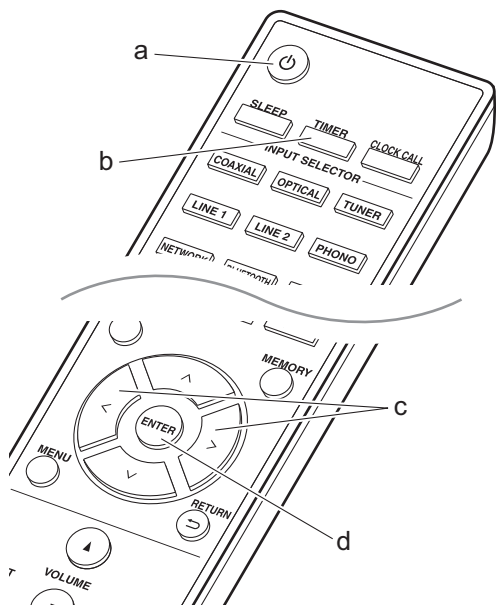

1. Press TIMER (b).

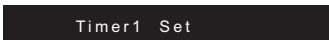

To set "TIMER 1", proceed to step 2. To set "TIMER 2", press TIMER (b) once more.

2. Press ENTER (d) when "Timer Set" is displayed.
3. Press </> (c) to select the source to use for timer play, then press ENTER (d).
 - The sources you can select are "CD", "MD" and "TUNER".

To select "CD" or "MD", you first need to go to the settings menu and set "Option" - "Selector Name" to set an input for a jack to "CD" or "MD". If "CD" or "MD" is not set for an input, nothing is output when the timer starts.

To select "TUNER", you first need to have registered a station in a preset channel.

4. If you have selected "TUNER", press </> (c) to select a preset number and press ENTER (d).
5. Press </> (c) to select "EVERY" or "ONCE" and press ENTER (d).

If you select "EVERY", select days of the week from amongst "EVERYDAY", "SUNDAY", "MONDAY", "TUESDAY", "WEDNESDAY", "THURSDAY", "FRIDAY", "SATURDAY", "MON-FRI", "TUE-SAT", and "SAT-SUN" and press ENTER (d).

If you select "ONCE", select a day of the week from amongst "SUNDAY", "MONDAY", "TUESDAY", "WEDNESDAY", "THURSDAY", "FRIDAY", or "SATURDAY" and press ENTER (d).

6. Press </> (c) to set the start time for the alarm and press ENTER (d).
Next set the hour and minutes for the start time.
7. Press </> (c) to set the end time for the alarm and press ENTER (d).

Next set the hour and minutes for the end time.

8. Press </> (c) to set the volume (00 to 50) for the alarm and press ENTER (d).
9. The TIMER indicator lights when the settings are complete, and the content you set is displayed on the display.
10. Press ⏻ (a) to switch the unit to standby.

Check whether the alarm setting is On or Off : When the TIMER indicator is on, the alarm is on. The alarm is off if the indicator is off.

Turning the alarm setting On or Off : If the alarm is already set, you can turn the function on or off.

1. Press TIMER (b).
2. "TIMER 1" is displayed. To modify "TIMER 1", proceed to step 3. To modify "TIMER 2", press TIMER (b) once more.
3. To turn off, press ENTER (d) when "Timer Off" is displayed.
 - To turn on, press ENTER (d) when "Timer On" is displayed.
 - Press </> (c) to select "Timer Call", then press ENTER (d) to check the content you set.
4. Press ⏻ (a) to switch the unit to standby.

Entering Text, Adjusting Sound Quality, etc.

Entering text

Text entry, for passwords, etc., uses the following procedure.

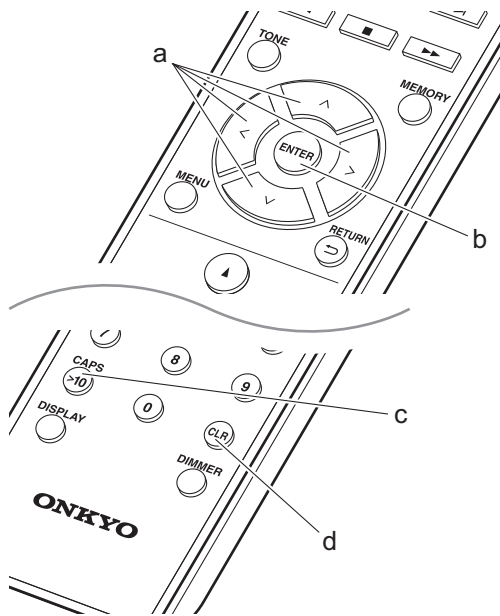

1. Select the characters or symbols with $\wedge/\vee/ </>$ (a).



2. Press ENTER (b) to confirm the selected character. Repeat this to enter text.
 - Press CAPS (c) to change the characters to be enter, for example to switch between upper and lower case.
 - Press CLR (d) to delete all the input characters.
3. After completing input, select "OK" with $\wedge/\vee/ </>$ (a) and press ENTER (b).

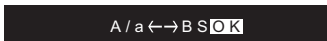

- Turn PUSH TO ENTER on the main unit to the left and right to select the characters, then press the dial to confirm.

Characters that can be entered

a

a	b	c	d	e	f	g	h	i	j	k	l	m
n	o	p	q	r	s	t	u	v	w	x	y	z
1	2	3	4	5	6	7	8	9	0	-	^	\
,	.	/	;	:	@	[]	S	p	a	c	e
A / a		< ->		B		S		O		K		

A

A	B	C	D	E	F	G	H	I	J	K	L	M
N	O	P	Q	R	S	T	U	V	W	X	Y	Z
!	"	#	\$	%	&	'	()	_	=	~	
<	>	?	+	*	`	{	}	S	p	a	c	e
A / a		< ->		B		S		O		K		

Space : A single space the size of a character is entered.

A/a : Switches between characters displayed. (a→A)

← (left) / → (right) : Select to move the cursor.

BS (backspace) : Removes a character on the left of the cursor. The cursor moves left.

OK : Confirms the entered content.

Adjusting the sound quality

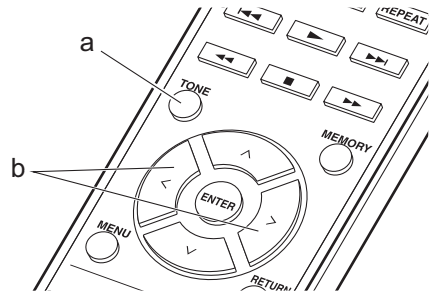

1. Repeatedly press TONE (a) to select the item to adjust.
2. Set with $</>$ (b).

Bass : Adjust the bass. (-6 to +6)

Treble : Adjust the treble. (-6 to +6)

Balance : Adjust the balance of the sounds output from the left and right speakers. (L6 to R6)

PM Bass : When "On", this enables the PM Bass function that emphasizes the bass.

Direct : When "On", this enables the Direct function that shuts down processing that affects sound quality so sound closer to the original is reproduced.

- When the Direct function is enabled, Bass, Treble, Balance, and PM Bass are disabled and you will be unable to set them.

Supplementary Information for Player Functions

Due to firmware (the software for the system) updates after you make your purchase or firmware changes during production of the product, there may be additions or changes to the features available compared to what is in the instruction manual.



<http://www.onkyo.com/manual/upd/nap/2.pdf>

Advanced Settings

The unit allows you to configure advanced settings to provide you with an even better experience.

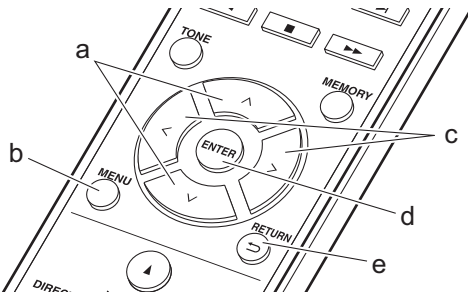

1. Press MENU (b) on the remote controller.
2. Select the item with \wedge/\vee (a) on the remote controller and press ENTER (d) to confirm.

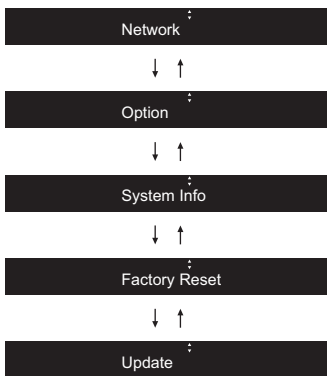

3. Select the settings with $\wedge/\vee/⟨/⟩$ (a, c) on the remote controller and press ENTER (d) to confirm.
 - To return to the previous screen, press \leftarrow (e).
4. To exit the settings, press MENU (b).

Network

■ Connection

Select the type connection to the network.
Select the item with $\langle/⟩$ (c) on the remote controller and press ENTER (d).

“Wi-Fi” : To connect via wireless LAN

“Wired” (Default Value) : To connect via wired LAN

Perform “Wi-Fi Setup” if you select “Wi-Fi”.

■ Wi-Fi Setup

Make Wi-Fi connection settings. (→P12)

This can be set only when “Wi-Fi” is selected in “Connection”.

■ SSID

The SSID of the connected access point is displayed.

■ Signal

The signal strength of the connected access point is displayed.

■ St

The connection status of the access point is displayed.

■ DHCP

Select the item with $\langle/⟩$ (c) on the remote controller and press ENTER (d).

“On” (Default Value) : Auto configuration by DHCP

“Off” : Manual configuration without DHCP

If selecting “Off”, you must set “IP Address”, “Subnet Mask”, “Gateway”, and “DNS” manually.

■ IP Address

Displays/Sets the IP address.

■ Subnet Mask

Displays/Sets the subnet mask.

■ Gateway

Displays/Sets the gateway.

■ DNS

Displays/Sets the primary DNS server.

■ Proxy URL

Displays/Sets the proxy server URL.

■ Proxy Port

Displays/Sets the proxy server port number when you enter “Proxy URL”.

■ Friendly Name

Change the device name for this unit which is shown on other devices connected to the network to an easily recognized name. You can input up to 31 characters. For details on how to enter text, refer to “Entering text” (→P28).

■ AirPlay PW

You can set a password of up to 31 characters so that only registered users can use AirPlay. For details on how to enter text, refer to “Entering text” (→P28).

■ Network Check

You can check the network connection. The confirmation results are displayed when you press ENTER (d).

Option

■ PWR Setting

Auto Standby	This setting places the unit on standby automatically after 20 minutes of inactivity without any audio input. Select the item with $\langle/⟩$ (c) on the remote controller and press ENTER (d). “On” (Default Value) : The unit will automatically enter standby mode. “Off” : The unit will not automatically enter standby mode.
--------------	--

NET Stby	<p>When this feature is turned "On", you can turn on the power of the unit via the network using an application that can control this unit.</p> <p>Select the item with </> (c) on the remote controller and press ENTER (d).</p> <ul style="list-style-type: none"> Setting to "On" (Default Value) increases the power consumption even when the unit is on standby. "NET Stby", which suppresses power consumption, may be disabled when the network connection is lost.
BT Wakeup	<p>This function wakes up the unit on standby by connecting a BLUETOOTH enabled device.</p> <p>Select the item with </> (c) on the remote controller and press ENTER (d).</p> <p>"On" : Use this function "Off" (Default Value) : Do not use this function</p> <ul style="list-style-type: none"> Setting to "On" increases the power consumption even when the unit is on standby. This setting is fixed to "Off" if "Bt Setting" - "InputChange" is set to "Off".

■ Tuner Setting

This is displayed only when "FM" or "DAB" is selected as the input source.

Search Level	<p>You can choose to have only those FM stations with strong reception selected when tuning into stations automatically if tuning regularly stops on FM stations with weak reception.</p> <p>Select the item with </> (c) on the remote controller and press ENTER (d).</p> <p>"Normal" (Default Value) "Strong" : Select only stations with strong reception.</p>
DAB Scan	<p>You can run the auto scan when new DAB stations are added or when you move house.</p>
DAB DRC	<p>With the DRC (Dynamic Range Control) setting, you can reduce the dynamic range of DAB digital radio so that you can still hear quiet parts even when listening at low volume levels - ideal for listening to the radio late at night when you don't want to disturb anyone.</p> <p>Select the item with </> (c) on the remote controller and press ENTER (d).</p> <p>"0" (Default Value) : DRC off "1" : Large reduction in dynamic range "1/2" : Small reduction in dynamic range</p>
Preset Write	Add the tuned station to the presets.
Preset Erase	Delete the tuned station from the presets.
NameEdit (FM stations only)	<p>You can give names to the stations that you have registered. For details on how to enter text, refer to "Entering text" (➔P28).</p>

■ Bt Setting

Bluetooth	<p>Select whether or not to use the BLUETOOTH function.</p> <p>Select the item with </> (c) on the remote controller and press ENTER (d).</p> <p>"On" (Default Value) : Enables connection with a BLUETOOTH enabled device by using the BLUETOOTH function. Select "On" also when making various BLUETOOTH settings. "Off" : When not using the BLUETOOTH function</p>
InputChange	<p>The input of the unit will automatically be switched to "BLUETOOTH" when connection is made from a BLUETOOTH enabled device to the unit.</p> <p>Select the item with </> (c) on the remote controller and press ENTER (d).</p> <p>"On" (Default Value) : The input will automatically become "BLUETOOTH" when a BLUETOOTH enabled device is connected. "Off" : The function is disabled.</p> <ul style="list-style-type: none"> If the input is not switched automatically, set to "Off" and change the input manually.
AutoReconnect	<p>This function automatically reconnects to the BLUETOOTH enabled device connected last when you change the input to "BLUETOOTH".</p> <p>Select the item with </> (c) on the remote controller and press ENTER (d).</p> <p>"On" (Default Value) : Use this function "Off" : Do not use this function</p> <ul style="list-style-type: none"> This may not work with some BLUETOOTH enabled devices.
Pairing Info	<p>You can initialize the pairing information saved on this unit. press ENTER (d) to initialize the pairing information stored in this unit.</p> <ul style="list-style-type: none"> This function does not initialize the pairing information on the BLUETOOTH enabled device. When pairing the unit again with the device, be sure to clear the pairing information on the BLUETOOTH enabled device in advance. For information on how to clear the pairing information, refer to the BLUETOOTH enabled device's instruction manual.
Device	Displays the name of the connected BLUETOOTH enabled device.
St	Displays the connection status of the BLUETOOTH enabled device.

■ Selector Name

This is displayed only when "COAXIAL", "OPTICAL", "LINE1", or "LINE2" is selected as the input source.

You can change the name of the input for the terminal to which you have connected a CD player or other external source to "CD" or "MD". You cannot change the name of the input for multiple jacks to "CD" or "MD". If you select "None" (Default Value), the name returns to the original input name.

Select the item with </> (c) on the remote controller

and press ENTER (d).

■ LINE OUT/SW

Change the settings according to the devices connected to the LINE OUT jacks on this unit. When changing this setting, perform without devices connected to the LINE OUT jacks.

Select the item with </> (c) on the remote controller and press ENTER (d).

"LINE OUT" (Default Value) : When connecting recording devices, such as a cassette tape deck

"SW PREOUT" : When connecting a subwoofer with built-in power amplifier

System Info

The MAC address of this unit and the current firmware version will be displayed.

Select "MAC address" or "Firmware" with ^/∨ (a) on the remote controller.

Factory Reset

Reset the settings of this unit to the status at the time of shipment. We recommend that you take a note of the settings you have changed before going ahead with a factory reset. To reset, select "Reset Start" with ^/∨ (a) on the remote controller and press ENTER (d). Press ENTER (d) again to start the reset. The unit will be placed on standby automatically when initializing is completed.

Update

"Update" is not displayed if there are no firmware updates.

■ via Network

Press ENTER (d) to select when you want to update the firmware via network.

■ via USB

Press ENTER (d) to select when you want to update the firmware via USB.

Firmware Update

The updating function on this unit

This unit has functionality to update the firmware (the system software) over a network or by the USB port. This enables us to make improvements to a variety of operations and to add features.

How to update

There are two methods for updating the firmware: via network and via USB. The update may take about 5 minutes to complete for either method: via network or via USB. Furthermore, existing settings are guaranteed regardless of the method used for update.

- For the latest information on updates, visit our company's website. There is no need to update the firmware on this unit if there is no update available.
- When performed over the network, it may take even more time depending on the connection status.
- During an update, do not
 - Disconnect and reconnect any cable or USB storage device, or perform any operation on the component such as turn off its power
 - Accessing this unit from a PC or smartphone using an application

Disclaimer: The program and accompanying online documentation are furnished to you for use at your own risk.

We will not be liable and you will have no remedy for damages for any claim of any kind whatsoever concerning your use of the program or the accompanying online documentation, regardless of legal theory, and whether arising in tort or contract.

In no event will we be liable to you or any third party for any special, indirect, incidental, or consequential damages of any kind, including, but not limited to, compensation, reimbursement or damages on account of the loss of present or prospective profits, loss of data, or for any other reason whatsoever.

Updating the Firmware via Network

- Check that the unit is turned on, and the connection to the Internet is secured.
- Turn off the controller component (PC etc.) connected to the network.
- Stop any playing Internet radio, USB storage device, or server content.

1. Press MENU on the remote controller to display "Network" on the display.



2. Press \wedge/\vee and ENTER to select "Update" - "via Network" in order.



- "Update" is not displayed if there are no firmware updates.
3. Press ENTER to start the firmware update.
 - "Completed" is displayed when the update is complete.
 4. Press \odot to switch the unit to standby. The process is

completed and your firmware is updated to the latest version.

If an error message is displayed : When an error occurs, " * - * * Error!" is displayed on the display of this unit. Check the following:

- * -01, * -10 : Ethernet cable not found. Connect the Ethernet cable properly.
- * -02, * -03, * -04, * -05, * -06, * -11, * -13, * -14, * -16, * -17, * -18, * -20, * -21 : Internet connection error. Check the following:
 - The router is turned on
 - This unit and the router are connected via the network

Try to disconnect and then connect again the power to the unit and router. This may solve the problem. If you are still unable to connect to the Internet, the DNS server or proxy server may be temporarily down. Check the service status with your ISP provider.

- Others : Disconnect then reconnect the power cord, then repeat from the beginning.

Updating via USB

- Prepare a 128 MB or larger USB storage device. FAT16 or FAT32 file system format.
- Delete any data stored on the USB storage device.
- Turn off the controller component (PC etc.) connected to the network.
- Stop any playing Internet radio, USB storage device, or server content.
- Some USB storage devices may take long to load, may not be loaded correctly, or may not be correctly fed depending on the device or their content.
- We will not be liable whatsoever for any loss or damage of data, or storage failure arising from the use of the USB storage device with this unit. Thank you for your understanding.

1. Connect the USB storage device to your PC.
2. Download the firmware file from our company's website to your PC and unzip.
Firmware files are named in the following way:
ONKHIM *****_*****_***.zip
Unzip the file on your PC. The number of unzipped files and folders varies depending on the model.
3. Copy all unzipped files and folders to the root folder of the USB storage device.
 - Make sure to copy the unzipped files.
4. Connect the USB storage device to the USB port of this unit.
 - If you connect a USB hard disk drive to the USB port of the unit, we recommend that you use its AC adapter to power it.
 - If the USB storage device has been partitioned, each section will be treated as an independent device.
5. Press MENU on the remote controller to display "Network" on the display.



6. Press \wedge/\vee and ENTER to select "Update" - "via USB" in order.



- "Update" is not displayed if there are no firmware

updates.

7. Press ENTER to start the firmware update.
 - “Completed” is displayed when the update is complete.
8. Press  to switch the unit to standby. The process is completed and your firmware is updated to the latest version.
9. Remove the USB storage device from this unit.

If an error message is displayed : When an error occurs, “ * - * * Error!” is displayed on the display of this unit. Check the following:

- * -01, * -10 : USB storage device not found. Check whether the USB storage device or USB cable is correctly inserted to the USB port of this unit. Connect the USB storage device to an external power source if it has its own power supply.
- * -05, * -13, * -20, * -21 : The firmware file is not present in the root folder of the USB storage device, or the firmware file is for another model. Retry from the download of the firmware file.
- Others : Disconnect then reconnect the power cord, then repeat from the beginning.

Troubleshooting

Before starting the procedure

When operation is unstable, problems may be solved by simply turning the power on or to standby or disconnecting/connecting the power cord, rather than reviewing settings and operations. Try the simple measures on both the unit and the connected device. If the problem isn't fixed after referring to "Troubleshooting", resetting the unit to the status at the time of shipment may solve the problem. Note that your settings will also be initialized when you reset, so we recommend that you note down your settings before doing the following.

Resetting the unit (this resets the unit settings to the default)

1. Press MENU on the remote controller, select "Factory Reset" - "Reset Start" and press ENTER.
2. Press ENTER.
3. The unit switches to standby and the settings are reset.

Power

■ Cannot turn on the unit

- Unplug the power cord from the wall outlet, wait 5 seconds or more, then plug it in again.

■ The unit turns off unexpectedly

- The unit automatically switches to standby when the "Option" - "PWR Setting" - "Auto Standby" setting in the setup menu functions.
- Check if the speaker cable wires are touching the rear panel or if the + side and - side have shorted. If there is contact or shorting, the unit will switch to standby automatically.
- If the power turns off and indicators around the VOLUME dial on the front panel continually blink, there may have been a malfunction with the amplifier or the protection circuit may have tripped. The protection circuit may trip in the following cases.
 - When playing at high volumes. Reduce the volume if this occurs.
 - When the wires in the speaker cables have touched the rear panel or other wires. Reconnect the wires so they do not protrude from the speaker terminals if this occurs.

If the same symptoms such as being unable to turn the unit on happen repeatedly, unplug the power cord from the wall outlet immediately and contact the dealer or our company's support.

Volume reduces after switching to standby

- This unit protects circuits by reducing the volume to 40 the next time the unit is switched on if the volume was above 40 when it was switched to standby.

Sound distorted when played at high volume

- Sound may be distorted when you play with the volume set above 30 with Bass settings made or with the "PM Bass" function enabled. Press TONE on the remote controller and reduce the level of the "Bass" or set "PM Bass" to "Off". (➔P28)

There is no audio from external devices

- There is no sound if this unit is muted. Press MUTING on the remote controller to cancel muting.
- Confirm that the connection between the output jack on the external device and the input jack on this unit is correct.
- Change the input selector on this unit to the position of the terminal to which the external device is connected.
- Check the digital audio output setting on the connected component. On some game consoles, such as those that support DVD, the default setting is off.

The display doesn't light

- The display may go dim while the DIMMER is working. Press DIMMER button and change the brightness level of the display.

Wi-Fi Connection

- Try plugging/unplugging the power supply of wireless LAN router and the unit, check the wireless LAN router power-on status, and try reboot of the wireless LAN router.

■ Cannot connect to the access point

- Check that the setting of SSID and encryption (WEP, etc.) is correct. Make sure the network settings of the unit is properly set.
- Connection to an SSID that includes multi-byte characters is not supported. Name the SSID of the wireless LAN router using single-byte alphanumeric characters only and try again.
- When the wireless LAN router setting is at stealth mode (mode to hide the SSID key) or when ANY connection is off, the SSID is not displayed. Change the setting and try again.

■ Connected to an SSID different to the SSID selected

- Some access points allow you to set multiple SSIDs for one unit. If you use the automatic setting button on such a router, you may end up connecting with a different SSID from the SSID you wanted to connect to. Use the connection method requiring you to enter a password if this happens.

■ Playback is interrupted and communication does not work

- Shorten the distance from the access point or remove obstacles to improve visibility, and try again. Place the unit away from microwave ovens or other access points. It is recommended to place the access point and the unit in the same room.
- If there is a metallic object near the unit, wireless LAN connection may not be possible as the metal can effect on the radio wave.
- When other access point are used near the unit, several issues such as interrupted playback and communication may occur. You can avoid these issues by changing the channel of the access point. For instructions on changing channels, see the instruction manual provided with the access point.

Cannot Play USB storage device / HDD

- Check whether the USB storage device or USB cable is correctly inserted to the USB port of the unit.
- Disconnect the USB storage device from the unit, and then try reconnecting.
- This unit may not recognize USB storage devices and HDDs as proper devices sometimes. Try switching this unit to standby and then turning it on again.
- Depending on the type of format, the playback may not be performed normally. Check the type of the file formats that is supported. (→P15)
- Cautions regarding USB and HDD devices (→P15)

FM reception is poor

- Re-check the antenna connection.
- Separate the antenna from speaker cables and the power cord.
- Move the unit away from your TV or PC.
- Passing cars and airplanes can cause interference.
- Concrete walls weaken radio signals.
- FM reception may become clearer if you use the antenna jack on the wall used for the TV.
- FM reception improves if the tuning mode is set to manual (→P18). However, reception will be monaural rather than stereo.

Network function

- If you cannot select a network service, it will become selectable when the network function is started.
- Try plugging/unplugging the power supply of this unit and the router, and try rebooting the router.

■ Cannot access the Internet radio

- Certain network service or contents available through the unit may not be accessible in case the service provider terminates its service.
- Make sure that your modem and router are properly connected, and make sure they are both turned on.
- Depending on ISP, setting the proxy server is necessary.
- Make sure that the used router and/or modem is supported by your ISP.

■ Cannot access the network server

- This unit needs to be connected to the same router as the network server.
- This unit is compatible with Windows Media® Player 11 or 12 network servers or NAS that are compatible with home network functionality. Furthermore, when using a PC, only music files registered in the Windows Media® Player library can be played.

■ Playback stops while listening to music files on the network server

- When the PC is serving as the network server, try quitting any application software other than the server software (Windows Media® Player 12, etc.).
- If the PC is downloading or copying large files, the playback may be interrupted.

■ The album names and artist names for the Music Server are not displayed

- Meta data, such as album names and artist names, needs to be recognized on the server for distribution to this unit, so this depends on the specifications of the NAS or server you are using.
- The file formats supported depend on the NAS or server software. For details, contact the manufacturer of NAS or the server software.

BLUETOOTH function

- Try plugging/unplugging the power of the unit and try turning on/off the BLUETOOTH enabled device. Restarting the BLUETOOTH enabled device may be effective.
- The BLUETOOTH enabled devices must support the A2DP profile.
- Near components such as microwave oven or cordless phone, which use the radio wave in the 2.4 GHz range, a radio wave interference may occur, which disables the use of this unit.
- If there is a metallic object near the unit, BLUETOOTH connection may not be possible as the metal can effect on the radio waves.
- In order to respond to operations on the remote controller of this unit, the BLUETOOTH enabled device must support the AVRCP profile.
- Note that operation with the remote controller is not always guaranteed with all BLUETOOTH enabled devices.

■ Cannot connect with this unit

- Check that the BLUETOOTH function of the BLUETOOTH enabled device is enabled.
- If an already paired unit cannot be connected, delete the pairing information on the BLUETOOTH enabled device, then pair again.

■ Music playback is unavailable on the unit even after successful BLUETOOTH connection

- When the audio volume of your BLUETOOTH enabled device is set low, the playback of audio may be unavailable.
- Some BLUETOOTH enabled devices may be equipped with a Send/Receive selector switch. Select Send mode.

■ Sound is interrupted

- There may be a problem with the BLUETOOTH enabled device. Check the information on the internet.

General Specifications

Audio Section

Rated Output Power (IEC)
2 ch × 70 W at 4 ohms, 1 kHz, 2 ch driven of 1% THD

THD+N (Total Harmonic Distortion+Noise)
0.08% (1 kHz, 8 ohms, 1 W)

Input Sensitivity and Impedance (1 kHz, 100 W/8 Ω)
200 mV/47 kΩ (LINE (Unbalance))
3.5 mV/47 kΩ (PHONO MM)

Rated RCA Output Level and Impedance
200 mV/2.2 kΩ (LINE OUT)

Phono Overload
70 mV (MM 1 kHz 0.5%)

Frequency Response
5 Hz - 60 kHz/+1 dB, -3 dB (Direct)

Tone Control Characteristics
±6 dB (100 Hz (Bass))
±6 dB (10 kHz (Treble))

Signal to Noise Ratio
106 dB (IHF-A, LINE IN, SP OUT)
80 dB (IHF-A, PHONO IN, SP OUT)

Supported Speaker Impedance
4 Ω - 16 Ω

Headphone Output Impedance
68 Ω

Headphone Rated Output
90 mW (32 Ω, 1 kHz, 10% THD)

Tuner Section

Tuning Frequency Range (FM)
87.5 MHz - 108.0 MHz, RDS

Preset Channel
40

Digital Tuner
DAB+

Network Section

ETHERNET LAN
10BASE-T/100BASE-TX

Wireless LAN (Wi-Fi)
IEEE 802.11 a/b/g/n standard
5 GHz/2.4 GHz band

BLUETOOTH Section

Communication system
BLUETOOTH Specification version 4.1+LE

Frequency band
2.4 GHz (2.402 GHz - 2.480 GHz)

Modulation method
FHSS (Freq Hopping Spread Spectrum)

Compatible BLUETOOTH profiles
A2DP 1.2, AVRCP 1.3,
HOGP-Host (Client), HOGP-HID Device (Server),
HID Service (HIDS)

Supported Codecs
SBC, AAC

Transmission range(A2DP)
20 Hz - 20 kHz (Sampling frequency 44.1 kHz)

Maximum communication range *
(Line of sight approx.) 15 m

* The actual range will vary depending on factors such as obstacles between devices, magnetic fields around a microwave oven, static electricity, cordless phone, reception sensitivity, antenna's performance, operating system, software application, etc.

General

Power Supply
AC 220 - 230 V, 50/60 Hz

Power Consumption
60 W
0.2 W (Standby)
22 W (No-sound)
2.8 W (Network Standby)

Dimensions (W × H × D)
275 mm × 87.7 mm × 303 mm

Weight
6.1 kg

Audio Inputs

Analog
LINE IN 1, 2
PHONO IN

Digital
OPTICAL
COAXIAL

Audio Outputs

LINE OUT
L/R

SPEAKER
L/R

Phones
Ø 3.5 mm stereo mini

USB

Front/Rear USB
Type A, USB2.0 High Speed

DC Output
5 V, 1 A (Rear) / 5 V, 0.5 A (Front)

License and Trademark Information



The Wi-Fi CERTIFIED Logo is a certification mark of Wi-Fi Alliance®.



AirPlay, iPad, iPhone, and iPod touch are trademarks of Apple Inc., registered in the U.S. and other countries.

iPad Air and iPad mini are trademarks of Apple Inc.

"Made for iPod", "Made for iPhone" and "Made for iPad" mean that an electronic accessory has been designed to connect specifically to iPod, iPhone, or iPad, respectively, and has been certified by the developer to meet Apple performance standards. Apple is not responsible for the operation of this device or its compliance with safety and regulatory standards.

Please note that the use of this accessory with iPod, iPhone or iPad may affect wireless performance.

AirPlay works with iPhone, iPad, and iPod touch with iOS 4.3.3 or later, Mac with OS X Mountain Lion or later, and PC with iTunes 10.2.2 or later.



The BLUETOOTH® word mark and logos are registered trademarks owned by Bluetooth SIG, Inc. and any use of such marks by Onkyo Corporation is under license. Other trademarks and trade names are those of their respective owners.

Onkyo Corporation does not guarantee BLUETOOTH compatibility between the AV receiver and all BLUETOOTH enabled devices.

For compatibility between the AV receiver and another device with BLUETOOTH technology, consult the device's documentation and dealer. In some countries, there may be restrictions on using BLUETOOTH devices. Check with your local authorities.

Onkyo Corporation ne garantit pas la compatibilité BLUETOOTH entre l'ampli-tuner AV et tous les appareils compatibles BLUETOOTH. Pour assurer la compatibilité entre l'ampli-tuner AV et un autre périphérique à technologie BLUETOOTH, consultez la documentation de l'appareil et le vendeur. Dans certains pays, il peut exister des restrictions sur l'utilisation d'appareils BLUETOOTH. Vérifiez auprès des autorités locales.

Onkyo Corporation no garantiza la compatibilidad BLUETOOTH entre el receptor de AV y todos los dispositivos con tecnología BLUETOOTH. Para obtener información sobre la compatibilidad entre el receptor de AV y otro dispositivo con tecnología BLUETOOTH, consulte al distribuidor y la documentación del dispositivo. En algunos países, es posible que el uso de dispositivos BLUETOOTH esté restringido. Consulte con las autoridades locales.

Onkyo Corporation non garantisce la compatibilità BLUETOOTH tra il ricevitore AV e tutti i dispositivi abilitati al BLUETOOTH. Per verificare la compatibilità tra il ricevitore AV e un altro dispositivo dotato di tecnologia BLUETOOTH, consultare la documentazione del dispositivo in questione o contattare il rivenditore. In alcuni Paesi potrebbero esistere delle limitazioni per l'utilizzo di dispositivi BLUETOOTH. Verificare le condizioni con le autorità locali.

Onkyo Corporation garantiert nicht die BLUETOOTH Kompatibilität zwischen dem AV-Receiver und allen BLUETOOTH fähigen Geräten. Zur Kompatibilität zwischen dem AV-Receiver und einem anderen Gerät mit BLUETOOTH Technologie, schauen Sie in die Dokumentation des Geräts und fragen Sie den Händler. Es kann sein, dass es in einigen Ländern Beschränkungen zur Nutzung der BLUETOOTH Geräte gibt. Prüfen Sie das bei Ihren lokalen Behörden.

Onkyo Corporation garandeert niet de BLUETOOTH compatibiliteit tussen de AV-receiver en alle BLUETOOTH apparaten. Raadpleeg voor compatibiliteit tussen de AV-receiver en een ander apparaat met BLUETOOTH technologie de documentatie van het apparaat of de verkoper. In sommige landen geldt mogelijk een beperking op het gebruik van BLUETOOTH apparatuur. Controleer de wetgeving in het land van gebruik.

Onkyo Corporation garanterar inte BLUETOOTH kompatibilitet mellan AV-receiver och alla BLUETOOTH aktiverade enheter.

För kompatibilitet mellan AV-receiver och en annan enhet med BLUETOOTH teknik, se enhetens dokumentation och återförsäljaren. I vissa länder kan det finnas begränsningar för användandet av BLUETOOTH enheter. Kontrollera hos de lokala myndigheterna.



The product with this logo is conformed to Hi-Res Audio standard defined by Japan Audio Society. This logo is used under license from Japan Audio Society.



"VLSC" and "VLSC (logo)" are trademarks of Onkyo Corporation.

This product is protected by certain intellectual property rights of Microsoft. Use or distribution of such technology outside of this product is prohibited without a license from Microsoft.

Windows and the Windows logo are trademarks of the Microsoft group of companies.

QR Code is a registered trademark of DENSO WAVE INCORPORATED.

DSD and the Direct Stream Digital logo are trademarks of Sony Corporation.

MPEG Layer-3 audio coding technology licensed from Fraunhofer IIS and Thomson.

"All other trademarks are the property of their respective owners."

"Toutes les autres marques commerciales sont la propriété de leurs détenteurs respectifs."

"El resto de marcas comerciales son propiedad de sus respectivos propietarios".

"Tutti gli altri marchi di fabbrica sono di proprietà dei rispettivi proprietari."

"Alle anderen Warenzeichen sind das Eigentum ihrer jeweiligen Eigentümer."

"Alle andere handelsmerken zijn eigendom van de desbetreffende rechthebbenden."

"Alla andra varumärken tillhör deras respektive ägare."

DISCLAIMER

Through this device you are able to link to other services or websites which are not under the control of any company which has designed, manufactured or distributed/have distributed this device, and its affiliates (collectively, "Company"). We have no control over the nature, content and availability of those services. The inclusion of any links does not necessarily imply a recommendation or endorse the views expressed within them.

All information, content and services available through this device belong to third parties and are protected by copyright, patent, trademark and/or other intellectual property laws of applicable countries.

The information, content and services provided through this device are for your personal, noncommercial use only. Any information, content or services may not be used in any manner other than previously approved by the appropriate content owner or service provider.

You may not modify, copy, republish, translate, exploit, create derivative works, upload, post, transmit, sell or distribute in any manner any information, content or services available through this device, unless expressly permitted by the appropriate copyright, patent, trademark and/or other intellectual property owner, including, without limitation, content owner or service provider.

THE CONTENT AND SERVICES AVAILABLE THROUGH THIS DEVICE ARE PROVIDED "AS IS".

COMPANY DOES NOT WARRANT INFORMATION, CONTENT OR SERVICES SO PROVIDED, EITHER EXPRESSLY OR IMPLIEDLY, FOR ANY PURPOSE.

COMPANY EXPRESSLY DISCLAIMS ANY WARRANTIES, EXPRESS OR IMPLIED, INCLUDING BUT NOT LIMITED TO, WARRANTIES OF TITLE, NON-INFRINGEMENT, MERCHANTABILITY OR FITNESS FOR A PARTICULAR PURPOSE.

Company makes no representation or warranty of any kind, express or implied, about the completeness, accuracy, validity, legality, reliability, suitability or availability with respect to the information, content or services available through this device. Company shall not be liable, whether in contract or tort, including negligence and strict liability, for any direct, indirect, special, incidental or consequential damages or any other damages arising out of, or in connection with, any information contained in, or as a result of the use of any content or service by you or any third party, even if Company has been advised of the possibility of such damages, nor shall Company be liable for any third party claims against users of this device or any third party.

In no event shall Company be responsible nor liable for, without limiting the generality of the foregoing, any interruption or suspension of any information, content or service available through this device. Company is neither responsible nor liable for customer service related to the information, content and services available through this device. Any question or request for service relating to the information, content or services should be made directly to the appropriate content owners and services providers.

Important Notice Regarding Software

The software packages installed in this product include software licensed to Onkyo & Pioneer Corporation (hereinafter, called "O&P Corporation") directly or indirectly by third party developers. Please be sure to read this notice regarding such software.

ソフトウェアに関する重要なお知らせ

本製品に搭載されるソフトウェアには、オンキヨー & パイオニア株式会社（以下「弊社」とします）が第三者より直接的に又は間接的に使用の許諾を受けたソフトウェアが含まれております。これらのソフトウェアに関する本お知らせを必ず一読ください。お問い合わせ先も記載してあります。

Notice Regarding GNU GPL/LGPL-applicable Software

This product includes the following software that is covered by GNU General Public License (hereinafter, called "GPL") or by GNU Lesser General Public License (hereinafter, called "LGPL"). O&P Corporation notifies you that, according to the attached GPL/LGPL, you have right to obtain, modify, and redistribute software source code for the listed software.

GNU GPL / LGPL 適用ソフトウェアに関するお知らせ

本製品には、以下の GNU General Public License（以下「GPL」とします）または GNU Lesser General Public License（以下「LGPL」とします）の適用を受けるソフトウェアが含まれております。お気づきの GPL / LGPL について、これらのソフトウェアソースコードの入手、改変、再配布の権利があることをお知らせいたします。

Package List / パッケージリスト

```
alsa-conf-base alsa-lib alsa-state alsa-utils-alsactl alsa-utils-alsamixer alsa-utils-amixer
alsa-utils-play base-files base-passwd base-zsh busybox ca-certificates devmem2 directfb dleyna-
connector-dbus eglibc-gconv eglibc-gconv-utf-16 gstreamer1.0-libav
gstreamer1.0-plugins-bad-aiff gstreamer1.0-plugins-bad-bluez
gstreamer1.0-plugins-bad-mms gstreamer1.0-plugins-bad-mpegtsdemux
gstreamer1.0-plugins-bad-mpg123 gstreamer1.0-plugins-bad-opus
gstreamer1.0-plugins-bad-sbc gstreamer1.0-plugins-bad-soundtouch gstreamer1.0-plugins-base-addr
gstreamer1.0-plugins-base-alsa gstreamer1.0-plugins-base-audioconvert
gstreamer1.0-plugins-base-audiotrate gstreamer1.0-plugins-base-audioresample gstreamer1.0-plugins-
base-audiotestsrc gstreamer1.0-plugins-base-encodebin
gstreamer1.0-plugins-base-ogg gstreamer1.0-plugins-base-playback
gstreamer1.0-plugins-base-tcp gstreamer1.0-plugins-base
gstreamer1.0-plugins-base-typefindfunctions gstreamer1.0-plugins-base-volume
gstreamer1.0-plugins-base-vorbis gstreamer1.0-plugins-good-apegap
gstreamer1.0-plugins-good-audioparsers gstreamer1.0-plugins-good-autodectect
gstreamer1.0-plugins-good-debug gstreamer1.0-plugins-good-ffmpeg
gstreamer1.0-plugins-good-gcdemux gstreamer1.0-plugins-good-h3demux
gstreamer1.0-plugins-good-isomp4 gstreamer1.0-plugins-good-level
gstreamer1.0-plugins-good-rtmpmanager gstreamer1.0-plugins-good-rtsp
gstreamer1.0-plugins-good-souphttpsrc gstreamer1.0-plugins-good
gstreamer1.0-plugins-good-udp gstreamer1.0-plugins-good-wavenc
gstreamer1.0-plugins-good-wavparse gstreamer1.0-plugins-ugly-ast
gstreamer1.0-plugins-ugly-gstreamer1.0-pgup-dns init-litupdown initscripts-functions initscripts
kernel-3.19.0 kernel-image-3.19.0 kernel-module-btmrvl-sdio
kernel-module-btmrvl kernel-module-mwifiex-sdio kernel-module-mwifiex kmmod libsound2
libasound-module-bluealsa libasound-module-usb-audio libblkid1 libbz2 libbsdmain0
libbdeyana-core-1.0-1 libbdeyana-server-1.0-1 libbfd3 libgcc1 libgcr1 libgcr11 libgce-0.8-2
libglib-2.0 libgmp3 libgnutls28 libgpg-error0 libgssdp-1.0-3 libgstdaudio-1.0-0 libgstpgm1-1.0-0
libgstpbutils-1.0-0 libgsttrif-1.0-0 libgsttrp-1.0-0 libgsttrsp-1.0-0 libgstts-1.0-0 libgsttsp-1.0-0
libgvideo-1.0-0 libgwp-1.0-4 liblbrp-0.2-2 liblbrp-0.2-2
libison-sax1.0 libkmod2 liblz2-2 liblms0 libnl-3-200 libnl3-cil libnl3-genl libnl3-ifn-3-200 libnl-
3-200 libopkg1 liborc0ee4 libotf0usb4 libqt4network4 libqt4xml4 libreadline5 libsoop-2.4
libstdc++6 libsystemd0 libzstd1 libzstd-dev libzstd-1.0 libzstd-dev libzstd-dev libzstd-dev
utils mtd-utils-ubifs netbase nettle pssh-default pssh rsync rygel sbc shared-mime-info-
data shared-mime-info sysfsutils sysvinit-initd sysvinit-pidof sysvinit-tail-conf uboot-stream800-
lv-utils udev-cache udev udev-init
update-alternatives-opkg update-rc.d ubutis-ids ubutis wireless-tools libiconv
ethtool-4.0 rtwvrv
```

Notice Regarding MPL-applicable Software

This product includes the following software that is covered by Mozilla Public License (hereinafter, called "MPL"). O&P Corporation notifies you that, according to the attached MPL, you have right to obtain, modify, and redistribute software source code for the listed software.

MPL 適用ソフトウェアに関するお知らせ

本製品には、以下の Mozilla Public License（以下「MPL」とします）の適用を受けるソフトウェアが含まれております。お気づきの MPL について、これらのソフトウェアソースコードの入手、改変、再配布の権利があることをお知らせいたします。

Package List / パッケージリスト

```
ca-certificates
```

GNU LESSER GENERAL PUBLIC LICENSE

Version 2.1, February 1999

Copyright (C) 1991, 1999 Free Software Foundation, Inc. 59 Temple Place, Suite 330, Boston, MA 02111-1307 USA Everyone is permitted to copy and distribute verbatim copies of this license document, but changing it is not allowed. [This is the first released version of the Lesser GPL. It also counts as the successor of the GNU Library License, version 2, hence the version number 2.1.]

Preamble

The licenses for most software are designed to take away your freedom to share and change it. By contrast, the GNU General Public Licenses are intended to guarantee you freedom to share and change free software—to make sure the software is free for all users. This license, the Lesser General Public License, applies to some specially designated software packages—typically libraries—of the Free Software Foundation and other authors who decide to use it. You can use it too, but we suggest you first think carefully about whether this license or the ordinary General Public License is the better strategy to use in any particular case, based on the explanations below. When we speak of free software, we are referring to freedom of use, not price. Our General Public Licenses are designed to make sure that you have the freedom to distribute copies of free software (and charge for this service if you wish), that you receive source code or can get it if you want it, that you can change the software and use pieces of it in new free programs; and that you are informed that you can do these things, to protect your rights, we need to make restrictions that forbid distributors to deny you these rights or to ask you to surrender these rights.

These restrictions translate to certain responsibilities for you if you distribute copies of the library or if you modify it. For example, if you distribute copies of the library, whether gratis or for a fee, you must give the recipients all the rights that we gave you. You must make sure that they, too, receive or can get the source code. If you link other code with the library, you must provide complete object files to the recipients, so that they can link them with the library after making changes to the library and recompiling it. And you must show them these terms so they know their rights. We protect your rights with a two-step method: (1) we copyright the library, and (2) we offer you this license, which gives you legal permission to copy, distribute and/or modify the library.

To protect each distributor, we want to make it very clear that there is no warranty for the library. Also, if the library is modified by someone else and passed on, the recipients should know that what they have is not the original version, so that the original author's reputation will not be affected by problems that might be introduced by others. Finally, software patents pose a constant threat to the existence of any free program; we wish to make sure that a company cannot effectively restrict the users of a free program by obtaining a restrictive license from a patent holder. Therefore, we insist that any patent license obtained for a version of the library must be consistent with the full freedom of use specified in this license. Most GNU software, including some libraries, is covered by the ordinary GNU General Public License. This license, the GNU Lesser General Public License, applies to certain designated libraries, and is quite different from the ordinary General Public License. We use this license for certain libraries in order to permit linking those libraries into non-free programs.

When a program is linked with a library, whether statically or using a shared library, the combination of the two is legally speaking a combined work, a derivative of the original library. The ordinary General Public License therefore permits such linking only if the entire combination fits its criteria of freedom. The Lesser General Public License permits more lax criteria for linking other code with the library. We call this license the "Lesser" General Public License because it does Less to protect the user's freedom than the ordinary General Public License. It also provides other free software developers Less of an advantage over competing non-free programs. These disadvantages are the reason we use the ordinary General Public License for many libraries. However, the Lesser license provides advantages in certain special circumstances. For example, there are occasions when it may be a special need to encourage the widest possible use of a certain library, so that it becomes a de-facto standard. To achieve this, non-free programs must be allowed to use the library.

A more frequent case is that a free library does the same job as widely used non-free libraries. In this case, there is free to gain by limiting the free library to free software only, so we use the Lesser General Public License. In other cases, permission to use a particular library in non-free programs enables a greater number of people to use a large body of free software. For example, permission to use the GNU C Library in non-free programs enables many more people to use the whole GNU operating system, as well as its variant, the GNU/Linux operating system. Although the Lesser General Public License is Less protective of the users' freedom, it does ensure that the user of a program that is linked with the Library has the freedom and the wherewithal to run that program using a modified version of the library. The precise terms and conditions for copying, distribution and modification follow. Pay close attention to the difference between a "work based on the library" and a "work that uses the library". The former contains code derived from the library, whereas the latter must be combined with the library in order to run.

TERMS AND CONDITIONS FOR COPYING, DISTRIBUTION AND MODIFICATION

0. This License Agreement applies to any software libraries or other programs which contain a notice placed by the copyright holder or other authorized party saying it may be distributed under the terms of this Lesser General Public License (also called "this License"). Each licensee is addressed as "you". A "library" means a collection of software functions and/or data prepared so as to be conveniently linked with application programs (which use some of those functions and data) to form executables. The "Library", below, refers to any such software library or work which has been distributed under these terms. A "work based on the Library" means either the Library or any derivative work based on copyright law; that is to say, a work containing the Library or a portion of it, either verbatim or with modifications and/or translated straightforwardly into another language. (Hereinafter, translation is included without limitation in the term "modification".) "Source code" for a work means the preferred form of the work for making modifications to it. For a library, complete source code means all modules, including all modules for copying, distribution and modification, plus the interface definition files, plus the scripts used to control compilation and installation of the library. Activities other than copying, distribution and modification are not covered by this License; they are outside its scope. The act of running a program using the Library is not restricted, and output from such a program is covered only if its contents constitute a work based on the Library (independent of the use of the Library in a

- tool for writing it). Whether that is true depends on what the Library does and what the program that uses the Library does.
1. You may copy and distribute verbatim copies of the Library's complete source code as you receive it, in any medium, provided that you conspicuously and appropriately publish on each copy an appropriate copyright notice and disclaimer of warranty, in the same manner as you have done for the Library, and you also include on each copy a reference to this License and to the absence of any warranty, and distribute a copy of this License along with the Library. You may charge a fee for the physical act of transferring a copy, and you may at your option offer warranty protection in exchange for a fee.
 2. You may modify your copy or copies of the Library or any portion of it, thus forming a work based on the Library, and copy and distribute such modifications or work under the terms of Section 1 above, provided that you also meet all of the following conditions:
 - a) The modified work must itself be a software library.
 - b) You must cause the files modified to carry prominent notices stating that you changed the files and the date of any change.
 - c) You must cause the whole of the work to be licensed at no charge to all third parties under the terms of this License.
 - d) If a facility in the modified Library refers to a function or a table of data to be supplied by an application program that uses the facility, then an argument passed when the facility is invoked, then you must make a good faith effort to ensure that, in the event no such function or table is supplied by the application, the facility still operates, and performs whatever part of its purpose remains meaningful. (For example, a function in a library to compute square roots has a purpose that is entirely well-defined independent of the application. Subsection 2c requires that any application-supplied function or table used by this function must be optional: if the application does not supply it, the square root function must still compute square roots.) These requirements apply to the modified work as a whole. If identifiable sections of that work are not derived from the Library, they can be reasonably considered independent and separate works in themselves, then this License, and its terms, do not apply to those sections when you distribute them as separate works. But when you distribute the same sections as part of a whole which is a work based on the Library, the distribution of the whole must be on the terms of this License, whose permissions for other licenses extend to that whole, and to each and every part regardless of who wrote it. Thus, it is not the intent of this section to claim rights or contest your rights to work written entirely by you; rather, the intent is to exercise the right to control the distribution of derivative or collective works based on the Library. In addition, those sections that are not based on the Library with the Library (or a work based on the Library) on a volume of a storage or distribution medium does not bring the other work under the scope of this License.
 3. You may opt to apply the terms of the ordinary GNU General Public License instead of this License to a given copy of the Library. To do this, you must alter all the notices that refer to this License, so that they refer to the ordinary GNU General Public License, version 2, instead of to this License. (If a newer version than version 2 of the ordinary GNU General Public License has appeared, then you can specify that version instead if you wish.) Do not make any other changes to these notices. Once this change is made in a given copy, it is irreversible for that copy, so the ordinary GNU General Public License applies to all subsequent copies and derivative works made from that copy. This option is useful when you wish to copy parts of the Library into your program. For example, you can reasonably consider independent and separate works in themselves, then this License, and its terms, do not apply to those sections when you distribute them as separate works. But when you distribute the same sections as part of a whole which is a work based on the Library, the distribution of the whole must be on the terms of this License, whose permissions for other licenses extend to that whole, and to each and every part regardless of who wrote it. Thus, it is not the intent of this section to claim rights or contest your rights to work written entirely by you; rather, the intent is to exercise the right to control the distribution of derivative or collective works based on the Library. In addition, those sections that are not based on the Library with the Library (or a work based on the Library) on a volume of a storage or distribution medium does not bring the other work under the scope of this License.
 4. You may copy and distribute the Library (or a portion or derivative of it, under Section 2) in object code or executable form under the terms of Sections 1 and 2 above provided that you accompany it with the complete corresponding machine-readable source code, which must be distributed under the terms of Sections 1 and 2 above on a medium customarily used for software interchange. If distribution of the object code is made by offering access to copy from a designated place, then offering equivalent access to copy the source code from the same place satisfies the requirement to distribute the source code, even though third parties are not compelled to copy the source along with the object code.
 5. A program that contains no derivative of any portion of the Library, but is designed to work with the Library by being compiled or linked with it, is called a "work that uses the Library". Such a work, in isolation, is not a derivative work of the Library, and therefore falls outside the scope of this License. However, linking a "work that uses the Library" with the Library creates an executable that is a derivative of the Library (because it contains portions of the Library), rather than a "work that uses the library". The executable is therefore covered by this License. Section 6 states terms for distribution of such executables. When a work that uses the Library is distributed by its author, it is part of the Library, the object code for the work may be a derivative work of the Library even though the source code is not. Whether this is true is especially significant if the work can be linked without the Library, or if the work is itself a library. The threshold for this to be true is not a fixed numerical count of the number of links, but whether it is practicable to separate the structure layouts and accessories, and small macros and small inline functions (ten lines or less in length), then the use of the object file is unrestricted, regardless of whether it is legally a derivative work. (Executables containing this object code plus portions of the Library will still fall under Section 6.) Otherwise, if the work is a derivative of the Library, you may distribute the object code for the work under the terms of Section 6, by executables containing that work also fall under Section 6, whether or not they are linked directly with the Library itself.
 6. As an exception to the Sections above, you may also combine or link a "work that uses the Library" with the Library to produce a work containing portions of the Library, and distribute that work under terms of your choice, provided that the terms permit modification of the work for the customer's own use and reverse engineering for debugging such modifications. You must give prominent notice with each copy of the work that the Library is used in it and that the Library and its use are covered by this License. You must supply a copy of this License. If the work during execution displays copyright notices, you must include the copyright notice for the Library among them, as well as a reference directing to a place where you can obtain the corresponding source code. You must do this in at least one of the following ways:
 - a) Accompany the work with the complete corresponding machine-readable source code for the Library including whatever changes were used in the work (which must be distributed under Sections 1 and 2 above); and, if the work is an executable linked with the Library, with the complete machine-readable "work that uses the Library", as object code or executable. You must ensure that the user can modify the Library and produce a modified executable containing the modified Library. (It is understood that the user who changes the contents of definitions files in the Library will not necessarily be able to recompile the application to use the modified definitions.)
 - b) Use a suitable shared library mechanism for linking with the Library. A suitable mechanism is one that (1) uses at run time a copy of the library already present on the user's computer system, rather than copying library functions and (2) will operate properly with a modified version of the library. If the user installs one, as long as the modified version is interface-compatible with the version that the work was made with.
 - c) Accompany the work with a written offer, valid for at least three years, to give the same user the materials specified in Subsection 6a above for a charge no more than the cost of copying them.
 - d) If distribution of the work is made by offering access to copy from a designated place, offer equivalent access to copy the above specified materials from the same place.e) Verify that the user has already received a copy of these materials or that you have already sent this user a copy.
 - For an executable, the required form of the "work that uses the Library" must include any data and utility programs needed for reproducing the executable from it. However, as a special exception, the materials to be distributed need not include anything that is normally distributed (either source or binary form) with the major components (compiler, kernel, and so on) of the operating system on which the executable runs, unless that component itself accompanies the executable. It may happen that this requirement contradicts the license restrictions of certain proprietary operating systems, but this does not automatically invalidate this contract. Such a contradiction means you cannot use both them and the Library together in an executable that you distribute.
 7. You may place library facilities that are a work based on the Library side-by-side in a single library together with other library facilities not covered by this License, and distribute such a combined library, provided that the separate distribution of the Library and of the other library facilities is otherwise permitted, and provided that you do these two things:
 - a) Accompany the combined library with a copy of the same work based on the Library, uncombined with any other library facilities, as described in the Sections above.
 - b) Give prominent notice with the combined library of the fact that part of it is a work based on the Library, and explaining where to find the accompanying uncombined form of the same work.
 8. You may not copy, modify, sublicense, link with, or distribute the Library if you are expressly provided under this License. Any attempt otherwise to copy, modify, sublicense, link with, or distribute the Library is void, and will automatically terminate your rights under this License. However, parties who have received copies, or rights, from you under this License will not have their licenses terminated so long as such parties remain in full compliance.
 9. You are not required to accept this License, since you have not signed it. However, nothing else grants you permission to modify or distribute the Library or its derivative works. These actions are prohibited by law if you do not accept this License. Therefore, by modifying or distributing the Library (or any work based on the Library), you indicate your acceptance of this License to do so, and all its terms and conditions for copying, distributing or modifying the Library or works based on it.
 10. Each time you redistribute the Library (or any work based on the Library), the recipient automatically receives a license from the original licensor to copy, distribute, link with or modify the Library subject to these terms and conditions. You may not impose any further restrictions on the recipients' exercise of the rights granted herein. You are not responsible for enforcing compliance by third parties with this License.
 11. If, as a consequence of your distribution or alteration of the work that carries this License, any other reason (not limited to patent issues), conditions are imposed on you (whether by court order, agreement or otherwise) that contradict the conditions of this License, they do not excuse you from the conditions of this License. If you cannot distribute so as to satisfy simultaneously your obligations under this License and any other pertinent obligations, then as a consequence you may not distribute the Library at all. For example, at a patent holder's insistence, you may not permit royalty-free redistribution of the Library by all those who receive copies directly or indirectly through you, then the only way you could satisfy both all of this License would be to refrain entirely from distribution of the Library.
If any portion of this section is held invalid or unenforceable under any particular circumstance, the balance of the section is intended to apply, and the section as a whole is intended to apply in other circumstances. It is not the purpose of this section to infringe any patent or other proprietary right, or to contest the validity of any such claims; this section has the sole purpose of protecting the integrity of the free software distribution system which is implemented by public license practices. Many people have made generous contributions to the wide range of software distributed through this system in reliance on consistent application of that system; your agreement to distribute the Library by this license will help you to continue that system; and your agreement to do so will help you to ensure that you are not imposing on others any system and a license cannot impose that choice. This section is intended to make throughly clear what is believed to be a consequence of the rest of this License.
 12. If the distribution of the Library is restricted by patents or by copyrighted interfaces, the original copyright holder who places the Library under this License may add an explicit geographical distribution limitation excluding those countries, so that distribution is permitted only in or among countries not thus excluded. In such case, this License incorporates the limitation as if written in the body of this License.
 13. The Free Software Foundation may publish revised and/or new versions of the Lesser General Public License from time to time. Such new versions will be similar in spirit to the present version, but may differ in detail to address new problems.
Each version is given a distinguishing version number. If the Library specifies a version number of this License which applies to it and "any later version", you have the option of following the terms and conditions either of that version or of any later version published by the Free Software Foundation. If the License does not specify a license version number, you may choose any version ever published by the Free Software Foundation.
 14. If you wish to incorporate parts of the Library into other free programs whose distribution conditions are incompatible with those of the Library, you are permitted to do so provided that you follow the terms of the Free Software Foundation, write to the Free Software Foundation; we sometimes make exceptions for this. Our decision will be guided by the two goals of preserving the free status of all derivatives of our free software and of promoting the sharing and reuse of software generally.

* NO WARRANTY

15. BECAUSE THE LIBRARY IS LICENSED FREE OF CHARGE, THERE IS NO WARRANTY FOR THE LIBRARY. TO THE EXTENT PERMITTED BY APPLICABLE LAW, EXCEPT WHEN OTHERWISE STATED IN WRITING THE COPYRIGHT HOLDERS AND/OR OTHER PARTIES PROVIDE THE LIBRARY "AS IS" WITHOUT WARRANTY OF ANY KIND, EITHER EXPRESSED OR IMPLIED, INCLUDING, BUT NOT LIMITED TO, THE IMPLIED WARRANTIES OF MERCHANTABILITY AND FITNESS FOR A PARTICULAR PURPOSE. THE ENTIRE RISK AS TO THE QUALITY AND PERFORMANCE OF THE LIBRARY IS WITH YOU. SHOULD THE LIBRARY PROVE DEFECTIVE, YOU ASSUME THE COST OF ALL NECESSARY SERVICING, REPAIR OR CORRECTION.
16. IN NO EVENT UNLESS REQUIRED BY APPLICABLE LAW OR AGREED TO IN WRITING WILL ANY COPYRIGHT HOLDER, OR ANY OTHER PARTY WHO MAY MODIFY AND/OR REDISTRIBUTE THE LIBRARY AS PERMITTED ABOVE, BE LIABLE TO YOU FOR DAMAGES, INCLUDING ANY GENERAL, SPECIAL, INCIDENTAL OR CONSEQUENTIAL DAMAGES ARISING OUT OF THE USE OR INABILITY TO USE THE LIBRARY (INCLUDING BUT NOT LIMITED TO LOSS OF DATA OR DATA BEING RENDERED INACCURATE OR LOSSES SUSTAINED BY YOU OR THIRD PARTIES OR A FAILURE OF THE LIBRARY TO OPERATE WITH ANY OTHER SOFTWARE), EVEN IF SUCH HOLDER OR OTHER PARTY HAS BEEN ADVISED OF THE POSSIBILITY OF SUCH DAMAGES.

END OF TERMS AND CONDITIONS

How to Apply These Terms to Your New Libraries

If you develop a new library, and you want it to be of the greatest possible use to the public, we recommend making it free software that everyone can redistribute and change. You can do so by permitting redistribution under these terms (or, alternatively, under the terms of the ordinary General Public License). To apply these terms, attach the following notices to the library. It is safest to attach them to the start of each source file to most effectively convey the exclusion of warranty, and each file should have at least the "copyright" line and a pointer to where the full notice is found.

Here is a sample; alter the names of the library and of any code that is not yours.

Copyright (C) <year> <name of author>

This library is free software; you can redistribute it and/or modify it under the terms of the GNU Lesser General Public License as published by the Free Software Foundation, either version 2.1 of the License, or (at your option) any later version. This library is distributed in the hope that it will be useful, but WITHOUT ANY WARRANTY; without even the implied warranty of MERCHANTABILITY or FITNESS FOR A PARTICULAR PURPOSE. See the GNU Lesser General Public License for more details. You should have received a copy of the GNU Lesser General Public License along with this library; if not, write to the Free Software Foundation, Inc., 59 Temple Place, Suite 330, Boston, MA 02111-1307 USA

Also add information on how to contact you by electronic and paper mail. You should also get your employer (if you work as a programmer) or your school, if any, to sign a "copyright disclaimer" for the library, if necessary. Here is a sample; alter the names:

Yoodyne, Inc., hereby disclaims all copyright interest in the library 'Frob' (a library for tweaking knobs) written by James Random Hacker.

signature of Ty Coon, 1 April 1990

Ty Coon, President of Yoodyne, Inc.

That's all there is to it!

GNU GENERAL PUBLIC LICENSE

Version 2, June 1991

Copyright (C) 1989, 1991 Free Software Foundation, Inc. 59 Temple Place - Suite 330, Boston, MA 02111-1307, USA

Everyone is permitted to copy and distribute verbatim copies of this license document, but changing it is not allowed.

Preamble

The licenses for most software are designed to take away your freedom to share and change it. By contrast, the GNU General Public License is intended to guarantee your freedom to share and change free software—to make sure the software is free for all users. This General Public License applies to most of the Free Software Foundation's software and to any other program whose authors commit to using it. (Some other Free Software Foundation software is licensed under its own separate licenses.) You can apply this license to your programs, too. When we speak of free software, we are referring to freedom, not price. Our General Public Licenses are designed to make sure that you have the freedom to distribute copies of free software (and charge for this service if you wish), that you receive source code or can get it if you want it, that you can change the software or use pieces of it in new free programs; and that you know you can do these things. To protect your rights, we need to make restrictions that forbid anyone to deny you these rights or to ask you to surrender the rights. These restrictions translate to certain responsibilities for you if you distribute copies of the software, or if you modify it. For example, if you distribute copies of such a program, whether gratis or for a fee, you must give the recipients all the rights that you have. You must make sure that they, too, receive or can get the source code. You and they must show to others how they got the source code. We protect your rights with two steps: (1) copyright the software, and (2) offer you this license which gives you legal permission to copy, distribute and/or modify the software. Also, for each author's protection and ours, we want to make certain that everyone understands that there is no warranty for this free software. If the software is modified by someone else and passed on, we want its recipients to know that what they have is not the original, so that any problems that come from those who are not original authors will not reflect on the original authors' reputations. Finally, any free program is threatened constantly by software patents. We wish to avoid the danger that redistributors of a free program will individually obtain patent licenses, in effect making the program proprietary. To prevent this, we have decided to license the software as free use or not licensed at all. The precise terms and conditions for copying, distribution and modification follow.

TERMS AND CONDITIONS FOR COPYING, DISTRIBUTION AND MODIFICATION

0. This License applies to any program or other work which contains a notice placed by the copyright holder saying it may be distributed under the terms of this General Public License. The "Program", below, refers to any such program or other work, and any derivative work based on the Program. It also applies to a copy or derivative work under copyright law; that is to say, a work containing the Program or a portion of it, either verbatim or with modifications and/or translated into another language. (Hereinafter, translation is included without limitation in the term "modification.") Each licensee is addressed as "you". Activities other than copying, distribution and modification are not covered by this License; they are outside its scope. The act of running the Program is not restricted, and the output from the Program is covered only if its contents constitute a work based on the Program (independent of having been made by running the Program). Whether that is true depends on what you are doing.

1. You may copy and distribute verbatim copies of the Program's source code as you receive it, in any medium, provided that you conspicuously and appropriately publish on each copy an appropriate copyright notice and disclaimer of warranty, in the same manner as you have done for the Library, and you also include on each copy a reference to this License and to the absence of any warranty, and give any other recipients of the Program a copy of this License along with the Program. You may charge a fee for the physical act of transferring a copy, and you may at your option offer warranty protection in exchange for a fee.
2. You may modify your copy or copies of the Program or any portion of it, thus forming a work based on the Program, and copy and distribute such modifications or work under the terms of Section 1 above, provided that you also meet all of these conditions:
 - a) You must cause the modified files to carry prominent notices stating that you changed the files and the date of any change.
 - b) You must cause any work that you distribute or publish, that in whole or in part contains or is derived from the Program or any part thereof, to be licensed as a whole at no charge to all third parties under the terms of this License.
 - c) If the modified program normally reads commands interactively when run, you must cause it, when started running for such interactive use in the most ordinary way, to print or display an announcement including an appropriate copyright notice and a notice that there is no warranty for the program, saying that you provide a warranty) and that users may redistribute the program under these conditions, and telling the user how to view a copy of this License. (Exception: if the Program itself is interactive but does not normally print such an announcement, your work based on the Program is not required to print an announcement.) These requirements apply to the modified work as a whole. If identifiable sections of that work are not derived from the Program, and can be reasonably considered independent and separate works in themselves, then this License, and its terms, do not apply to those sections when you distribute them as separate works. But when you distribute the same sections as part of a whole which is a work based on the Program, the distribution of the whole must be on the terms of this License, whose permissions for other licensees extend to the entire whole, and thus to each and every part regardless of who wrote it. Thus, it is not the intent of this section to claim rights or contest your rights to work written entirely by you; rather, the intent is to exercise the right to control the distribution of derivative or collective works based on the Program. In addition, mere aggregation of another work not based on the Program with the Program (or with a work based on the Program) on a volume of a storage or distribution medium does not bring the other work under the scope of this License.
3. You may copy and distribute the Program (or a work based on it, under Section 2) in object code or executable form under the terms of Sections 1 and 2 above provided that you also do one of the following:
 - a) Accompany it with the complete corresponding machine-readable source code, which must be distributed under the terms of Sections 1 and 2 above on a medium customarily used for software interchange; or
 - b) Accompany it with a written offer, valid for at least three years, to give any third party, for a charge no more than your cost of physically performing source distribution, a complete and machine-readable copy of the corresponding source code, which must be distributed under the terms of Sections 1 and 2 above on a medium customarily used for software interchange; or
 - c) Accompany it with the information you received as to how to obtain the corresponding source code. (This alternative is allowed only if the distribution and only if you received the program in object code or executable form with such an offer, in accord with Subsection b above.)The source code for a work means the preferred form of the work for making modifications to it. For an executable work, complete source code means all the source code for all modules it contains, plus any associated interface definition files, scripts used to control compilation and installation of the executable. However, as a special exception, the source code distributed need not include anything that is normally distributed (in either source or binary form) with the major components (compiler, kernel, and so on) of the operating system on which the executable runs, unless that component itself accompanies the executable. If distribution of executable or object code is made by offering access to copy from a designated place, then offering equivalent access to copy the source code from the same place counts as distribution of the source code, even though third parties are not compelled to copy the source along with the object code.
4. You may not copy, modify, sublicense, or distribute the Program except as expressly provided under this License. Any attempt otherwise to copy, modify, sublicense or distribute the Program is void, and will automatically terminate your rights under this License. However, parties who have received copies, or rights, from you under this License will not have their licenses terminated so long as such parties remain in full compliance.
5. You are not required to accept this License, since you have not signed it. However, nothing else grants you permission to modify or distribute the Program or its derivative works. These actions are prohibited by law if you do not accept this License. Therefore, by modifying or distributing the Program (or any work based on the Program), you indicate your acceptance of this License to do so, and all its terms and conditions for copying, distributing or modifying the Program or works based on it.
6. Each time you redistribute the Program (or any work based on the Program), the recipient automatically receives a license from the original licensor to copy, distribute or modify the Program subject to these terms and

- conditions. You may not impose any further restrictions on the recipients' exercise of the rights granted herein. You are not responsible for enforcing compliance by third parties to this License.
7. If, as a consequence of a court judgment or allegation of patent infringement or for any other reason (not limited to patent issues), conditions are imposed on you (whether by court order, agreement or otherwise) that conflict with the conditions of this License, they do not excuse you from the conditions of this License. If you cannot distribute so as to satisfy simultaneously your obligations under this License and any other pertinent obligations, then as a consequence you may not distribute the Program at all. For example, if a patent license would not permit you to copy, distribute or otherwise make copies of the Program, then as a consequence you may not distribute the Program at all. If you are unable to do so, then the only way you could satisfy both it and this License would be to refrain entirely from distribution of the Program.
- If any portion of this section is held invalid or unenforceable under any particular circumstance, the balance of the section is intended to apply and the section as a whole is intended to apply in other circumstances. It is not the purpose of this section to induce you to infringe any patents or other property right claims or to contest validity of any such claims; this section has the sole purpose of protecting the integrity of the free software distribution system which is implemented by public license practices. Many people have made generous contributions to the wide range of software distributed through that system in reliance on consistent application of that system; it is up to the author/donor to decide if he or she is willing to distribute software through any other channel, and you are not responsible for enforcing that decision. This section is intended to make thoroughly clear what is believed to be a consequence of the rest of this License.
8. If the distribution and/or use of the Program is restricted in certain countries either by patents or by copyrighted interfaces, the original copyright holder who places the Program under this License may add an explicit geographical distribution limitation excluding those countries, so that distribution is permitted only in or among countries not thus excluded. In such case, this License incorporates the limitation as if written in the body of this License.
9. The Free Software Foundation may publish revised and/or new versions of the General Public License from time to time. Such new versions will be similar in spirit to the present version, but may differ in detail to address new problems or concerns.
- Each version is given a distinguishing version number. If the Program specifies a version number of this License which applies to it and "any later version", you have the option of following the terms and conditions either of that version or of any later version published by the Free Software Foundation. If the Program does not specify a version number of this License, you may choose any version ever published by the Free Software Foundation.
10. If you wish to incorporate parts of the Program into other free programs whose distribution conditions are different, write to the author to ask for permission. For software which is copyrighted by the Free Software Foundation, write to the Free Software Foundation; for software which is not, write to the copyright holder. Permission is granted by you, the author or copyright holder, to those who receive copies directly or indirectly, to copy and distribute the program under the terms of the GNU General Public License, provided that you also meet all the other requirements of this license. This section is intended to make thoroughly clear what is believed to be a consequence of the rest of this License.

NO WARRANTY

11. **BECAUSE THE PROGRAM IS LICENSED FREE OF CHARGE, THERE IS NO WARRANTY FOR THE PROGRAM, TO THE EXTENT PERMITTED BY APPLICABLE LAW, EXCEPT WHEN OTHERWISE STATED IN WRITING THE COPYRIGHT HOLDERS AND/OR OTHER PARTIES PROVIDE THE PROGRAM "AS IS" WITHOUT WARRANTY OF ANY KIND, EITHER EXPRESSED OR IMPLIED, INCLUDING, BUT NOT LIMITED TO, THE IMPLIED WARRANTIES OF MERCHANTABILITY AND FITNESS FOR A PARTICULAR PURPOSE. THE ENTIRE RISK AS TO THE QUALITY AND PERFORMANCE OF THE PROGRAM IS WITH YOU. SHOULD THE PROGRAM PROVE DEFECTIVE, YOU ASSUME THE COST OF ALL NECESSARY SERVICING, REPAIR OR CORRECTION.**
12. **IN NO EVENT UNLESS REQUIRED BY APPLICABLE LAW OR AGREED TO IN WRITING WILL ANY COPYRIGHT HOLDER, OR ANY OTHER PARTY WHO MAY MODIFY AND/OR REDISTRIBUTE THE PROGRAM AS PERMITTED ABOVE, BE LIABLE TO YOU FOR DAMAGES, INCLUDING ANY GENERAL, SPECIAL, INCIDENTAL OR CONSEQUENTIAL DAMAGES ARISING OUT OF THE USE OR INABILITY TO USE THE PROGRAM (INCLUDING BUT NOT LIMITED TO LOSS OF DATA OR DATA BEING RENDERED INACCURATE OR LOSSES SUSTAINED BY YOU OR THIRD PARTIES OR A FAILURE OF THE PROGRAM TO OPERATE WITH ANY OTHER PROGRAMS), EVEN IF SUCH HOLDER OR OTHER PARTY HAS BEEN ADVISED OF THE POSSIBILITY OF SUCH DAMAGES.**

END OF TERMS AND CONDITIONS

How to Apply These Terms to Your New Programs

If you develop a new program, and you want it to be of the greatest possible use to the public, the best way to achieve this is to make it free software which everyone can redistribute and charge under these terms. To do so, attach the following notices to the program. It is safest to attach them to the start of each source file to most effectively convey the exact meaning of the warranty, and each file should have at least the "copyright" line and a pointer to where the full notice is found.

<one line to give the program's name and an idea of what it does.>

Copyright (C) <year> <name of copyright holder>
 This program is free software; you can redistribute it and/or modify it under the terms of the GNU General Public License as published by the Free Software Foundation; either version 2 of the License, or (at your option) any later version. This program is distributed in the hope that it will be useful, but WITHOUT ANY WARRANTY; without even the implied warranty of MERCHANTABILITY or FITNESS FOR A PARTICULAR PURPOSE. See the GNU General Public License for more details. You should have received a copy of the GNU General Public License along with this program; if not, write to the Free Software Foundation, Inc., 59 Temple Place - Suite 330, Boston, MA 02111-1307, USA.

Also add information on how to contact you by electronic and paper mail. If the program is interactive, make it output a short notice like this when it starts in an interactive mode:

Gnomovision version 69, Copyright (C) 1989 by Name of Author/Gnomovision comes with ABSOLUTELY NO WARRANTY; for details type `show w'. This is free software, and you are welcome to redistribute it under certain conditions; type `show c' for details.

The hypothetical commands 'show w' and 'show c' should show the appropriate parts of the General Public License. Of course, the commands you use may be called something other than 'show w' and 'show c'; they could even be mouse-clicks or menu items—whatever suits your program. You should also get your employer (if you work as a programmer) or your school, if any, to sign a "copyright disclaimer" for the program, if necessary. Here is a sample; alter the names:

Yooyodyne, Inc., hereby disclaims all copyright interest in the program 'Gnomovision' (which makes passes at compilers) written by James Hacker.
 <signature of Ty Coon>, 1 April 1989
 Ty Coon, President of Yooyodyne, Inc.

This General Public License does not permit incorporating your program into proprietary programs. If your program is a subroutine library, you may consider it more useful to permit linking proprietary applications with the library. If this is what you want to do, use the GNU Library General Public License instead of this License.

Mozilla Public License Version 2.0

1. Definitions

- 1.1. **"Contributor"** means each individual or legal entity that creates, contributes to the creation of, or owns Covered Software.
- 1.2. **"Contributor Version"** means the combination of the Contributions of others (if any) used by a Contributor and that particular Contributor's Contribution.
- 1.3. **"Contribution"** means Covered Software of a particular Contributor.
- 1.4. **"Covered Software"** means Source Code Form to which the initial Contributor has attached the notice in Exhibit A, the Executable Form of such Source Code Form, and Modifications of such Source Code Form, in each case including portions thereof.

- 1.5. **"Incompatible With Secondary Licenses"** means (a) that the initial Contributor has attached the notice described in Exhibit B to the Covered Software; or (b) that the Covered Software was made available under the terms of version 1.1 or earlier of the License, but not also under the terms of a Secondary License.
- 1.6. **"Executable Form"** means any form of the work other than Source Code Form.
- 1.7. **"Larger Work"** means a work that combines Covered Software with other material, in a separate file or files, that is not Covered Software.
- 1.8. **"License"** means this document.
- 1.9. **"Licensesable"** means having the right to grant, to the maximum extent possible, whether at the time of the initial grant or subsequently, any and all of the rights conveyed by this License.

- 1.10. **"Modifications"** means any of the following: (a) any file in Source Code Form that results from an addition to, deletion from, or modification of the contents of Covered Software; or (b) any new file in Source Code Form that contains any Covered Software.
- 1.11. **"Patent Claims"** means any patent claims, including without limitation, method, process, and apparatus claims, in any patent Licensesable by such Contributor that would be infringed, but for the grant of the License, by the making, using, selling, offering for sale, having made, import, or transfer of either its Contributions or its Contributor Version.
- 1.12. **"Secondary License"** means either the GNU General Public License, Version 2.0, the GNU Lesser General Public License, Version 2.1, the GNU Affero General Public License, Version 3.0, or any later versions of those licenses.

- 1.13. **"Source Code Form"** means the form of the work preferred for making modifications.
- 1.14. **"You"** or **"Your"** means an individual or a legal entity exercising rights under this License. For legal entities, "You" includes any entity that controls, is controlled by, or is under common control with You. For purposes of this definition, "control" means (a) the power, direct or indirect, to cause the direction or management of such entity, whether by contract or otherwise, or (b) ownership of more than fifty percent (50%) of the outstanding shares or beneficial ownership of such entity.

2. License Grants and Conditions
- 2.1. Grants
- Each Contributor hereby grants You a world-wide, royalty-free, non-exclusive license:
- (a) under intellectual property rights (other than patent or trademark) Licensesable by such Contributor to use, reproduce, make available, modify, display, perform, distribute, and otherwise exploit its Contributions, either on an unmodified basis, with Modifications, or as part of a Larger Work; and
- (b) under Patent Claims of such Contributor to make, use, sell, offer for sale, have made, import, and otherwise transfer either its Contributions or its Contributor Version.

- 2.2. Effective Date
- This License shall be deemed to apply to any Contributions to which you were already bound prior to the date of this License. However, to the extent you have not already agreed to this License (or a later version), this License shall be deemed to apply only to those Contributions to which you were not already bound prior to the date of this License.

The licenses granted in Section 2.1 with respect to any Contribution become effective for each Contribution on the date the Contributor first distributes such Contribution.

- 2.3. **Limitations on Grant Scope**
- The licenses granted in this Section 2 are the only rights granted under this License. No additional rights or licenses will be implied from the distribution or licensing of Covered Software under this License. Notwithstanding Section 2.1(b) above, no patent license is granted by a Contributor:
- (a) for any code that a Contributor has removed from Covered Software; or
- (b) for infringements caused by: (i) You and any other third party's modifications of Covered Software, or (ii) the combination of its Contributions with other software (except as part of its Contributor Version); or (c) under Patent Claims infringed by Covered Software in the absence of its Contributions.
- This License does not grant any rights in the trademarks, service marks, or logos of any Contributor (except as may be necessary to comply with the notice requirements in Section 3.4).

- 2.4. **Subsequent Licenses**
- No Contributor makes additional grants as a result of Your choice to distribute the Covered Software under a subsequent version of this License (see Section 10.2) or under the terms of a Secondary License (if permitted under the terms of Section 3.3).
- 2.5. **Representation**
- Each Contributor represents that the Contributor believes its Contributions are its original creation(s) or it has sufficient rights to grant the rights to its Contributions conveyed by this License.

- 2.6. **Fair Use**
- This License is not intended to limit any rights You have under applicable copyright doctrines of fair use, fair dealing, or other equivalents.
- 2.7. **Conditions**
- Sections 3.1, 3.2, 3.3, and 3.4 are conditions of the licenses granted in Section 2.1.

3. Responsibilities
- 3.1. **Distribution of Source Form**
- All distribution of Covered Software in Source Code Form, including any Modifications that You create or to which You contribute, must be under the terms of this License. You must inform recipients that the Source Code Form of the Covered Software is governed by the terms of this License, and how they can obtain a copy of this License. You may not attempt to restrict the recipients' rights in the Source Code Form.

- 3.2. **Distribution of Executable Form**
- If you distribute Covered Software in Executable Form then:
- (a) such Covered Software must also be made available in Source Code Form, as described in Section 3.1, and You must inform recipients how they can obtain a copy of such Source Code Form by reasonable means in a timely manner, at a charge no more than the cost of distribution to the recipient; and
- (b) You may distribute such Executable Form under the terms of this License, or sublicense it under different terms, provided that the license for the Executable Form does not attempt to limit or alter the recipients' rights in the Source Code Form under this License.

- 3.3. **Distribution of a Larger Work**
- You may create and distribute a Larger Work under terms of Your choice, provided that You also comply with the requirements of this License for the Covered Software. If the Larger Work is a combination of Covered Software with other material, You must ensure that the other material is licensed under the terms of a Secondary License. This License permits You to additionally distribute such Covered Software under the terms of such Secondary License(s), so that the recipient of the Larger Work may, at their option, further distribute the Covered Software under the terms of either this License or such Secondary License(s).

- 3.4. **Notices**
- You may not remove or alter the substance of any license notices (including copyright notices, patent notices, disclaimers of warranty, or limitations of liability) contained within the Source Code Form of the Covered Software, except that You may alter any license notices to the extent required to remedy known factual inaccuracies.

- 3.5. **Application of Additional Terms**
- You may choose to offer, and to charge a fee for, warranty, support, indemnity or liability obligations to one or more recipients of Covered Software. However, you may do so only on Your own behalf, and not on behalf of any Contributor. You must make it absolutely clear that any such warranty, support, indemnity, or liability obligation is offered by You alone, and that You hereby agree to indemnify every Contributor for any liability incurred by such Contributor as a result of your offering warranty, support, indemnity or liability terms. You offer. You may include additional disclaimers of warranty and limitations of liability specific to your jurisdiction.

4. **Inability to Comply Due to Statute or Regulation**
- If it is impossible for You to comply with any of the terms of this License with respect to some or all of the Covered Software due to statute, judicial order, or regulation then You must: (a) comply with the terms of this License to the maximum extent possible; and (b) describe the limitations and the code they affect. Such description must be included in a text file included with all distributions of the Covered Software under this License. Except to the extent prohibited by statute or regulation, such description must be sufficiently detailed for a recipient of ordinary skill to be able to understand it.

5. **Termination**
- 5.1. The rights granted under this License will terminate automatically if You fail to comply with any of its terms. However, if You become compliant, then the rights granted under this License from a particular Contributor are reinstated (a) provisionally, unless and until such Contributor explicitly and finally terminates Your grants, and (b) on an ongoing basis, if such Contributor fails to notify You of the non-compliance by some reasonable means (including electronic mail) within 60 days after the non-compliance. Moreover, any grants granted from a particular Contributor are reinstated on an ongoing basis if such Contributor notifies You of the non-compliance by some reasonable means, this is the first time You have received notice of non-compliance with this License from such Contributor, and You become compliant prior to 30 days after Your receipt of the notice.
- 5.2. If You initiate litigation against any entity by asserting a patent infringement claim (excluding declaratory judgment actions, counter-claims, and cross-claims) alleging that a Contributor Version directly or indirectly infringes any patent, then the rights granted to You by any and all Contributors for the Covered Software under this License are terminated as of the date the litigation is filed.

- 5.3. In the event of termination under Sections 5.1 or 5.2 above, all end user license agreements (excluding distributors and resellers) which have been validly granted by You or Your distributors under this License prior to termination shall survive termination.

6. Disclaimer of Warranty

Covered Software is provided under this License on an "as is" basis, without warranty of any kind, either expressed, implied, or statutory, including, without limitation, warranties that the Covered Software is free of defects, merchantable, fit for a particular purpose or non-infringing. The entire risk as to the quality and performance of the Covered Software is with You. Should any Covered Software prove defective in any respect, You (not any Contributor) assume the cost of any necessary servicing, repair, or correction. This disclaimer of warranty constitutes an essential part of this License. No use of any Covered Software is authorized under this License except under this disclaimer.

7. Limitation of Liability

Under no circumstances and under no legal theory, whether tort (including negligence), contract, or otherwise, shall any Contributor, or anyone who distributes Covered Software as permitted above, be liable to You for any direct, indirect, special, incidental, or consequential damages of any character whatsoever, including, without limitation, damages for lost profits, loss of goodwill, work stoppage, computer failure or malfunction, or any and all other commercial damages or losses, even if such party shall have been informed of the possibility of such damages. This limitation of liability shall not apply to liability for death or personal injury resulting from such party's negligence to the extent applicable law prohibits such limitation. Some jurisdictions do not allow the exclusion or limitation of incidental or consequential damages, so this exclusion and limitation may not apply to You.

8. Litigation

Any litigation relating to this License may be brought only in the courts of a jurisdiction where the defendant maintains its principal place of business and such litigation shall be governed by laws of that jurisdiction, without reference to its conflict-of-law provisions. Nothing in this Section shall prevent a party's ability to bring cross-claims or counter-claims.

9. Miscellaneous

This License represents the complete agreement concerning the subject matter hereof. If any provision of this License is held to be unenforceable, such provision shall be reformed only to the extent necessary to make it enforceable. Any law or regulation which provides that the language of a contract shall be construed against the drafter shall not be used to construe this License against a Contributor.

10. Versions of the License

10.1. **New Versions**

Mozilla Foundation is the license steward. Except as provided in Section 10.3, no one other than the license steward has the right to modify or publish new versions of this License. Each version will be given a distinguishing version number.

10.2. **Effect of New Versions**

You may distribute the Covered Software under the terms of the version of the License under which You originally received the Covered Software, or under the terms of any subsequent version published by the license steward.

10.3. **Modified Versions**

If you create software not governed by this License, and you want to create a new license for such software, you may create and use a license that is derived from the terms of this License and rename the license and references to the name of the license steward (except to note that such modified license differs from this License).

10.4. **Distributing Source Code Form that is Incompatible With Secondary Licenses**

If You choose to distribute Source Code Form that is Incompatible With Secondary Licenses under the terms of this version of the License, the recipient of the Source Code Form must be notified that any distribution of such Source Code Form that is not licensed under this License is prohibited. Exhibit B of this License must be attached.

Exhibit A - Source Code Form License Notice

This Source Code Form is subject to the terms of the Mozilla Public License, v. 2.0. If a copy of the MPL was not distributed with this file, You can obtain one at <http://mozilla.org/MPL/2.0/>.

If it is not possible or desirable to put the notice in a particular file, then You may include the notice in a location (such as a LICENSE file in a larger project) where a recipient would be likely to look for such a notice.

You may add additional accurate notices of copyright ownership.

Exhibit B - "Incompatible With Secondary Licenses" Notice

This Source Code Form is "Incompatible With Secondary Licenses", as defined by the Mozilla Public License, v. 2.0.

Notice Regarding Third-party Software / その他第三者ソフトウェアに関するお知らせ

This product includes the following software that is directly or indirectly licensed to O&P Corporation by third-party developers. Please refer to the PDF files on the following website about the notice in response to requests from the copyright owners of each piece of software.

<http://www.onkyo.com/manual/oss/2016wsp.pdf>

本製品には弊社が第三者より直接的に又は間接的に使用の許諾を受けた下記ソフトウェアが含まれております。各ソフトウェアの著作権者の要求に基づく通知については、以下のサイトよりPDFファイルをご参照ください。

<http://www.onkyo.com/manual/oss/2016wsp.pdf>

curl
Copyright (c) 1996 - 2015, Daniel Stenberg, danie@haxx.se. All rights reserved.

dbus-1
This license is Copyright (C) 2003-2004 Lawrence E. Rosen. All rights reserved.

dropbear
Copyright (c) 2002-2013 Matt Johnston
Portions copyright (c) 2004 Minnea Stoenescu
All rights reserved.

hostap-daemon
Copyright (c) 2002-2012, Jouni Malinen <j@w1.fi> and contributors
All Rights Reserved.

iw
Copyright (c) 2007, 2008 Johannes Berg
Copyright (c) 2007 Andy Lutomiński
Copyright (c) 2007 Mike Kershaw
Copyright (c) 2008-2009 Luis R. Rodriguez

libbz2-0
This program, "bz2", the associated library "libbz2", and all documentation, are copyright (C) 1996-2010 Julian R. Seward. All rights reserved.

libcap2
Copyright (c) 1997-8, 2008 Andrew G. Morgan <morgan@kernel.org>

libcrypto1.0.0
Copyright (c) 1998-2011 The OpenSSL Project. All rights reserved.

libcurl5
Copyright (c) 1996 - 2014, Daniel Stenberg, <daniel@haxx.se>. All rights reserved.

libdbus-1-3
Copyright (C) 2003-2004 Lawrence E. Rosen. All rights reserved.

libexpat1
Copyright (c) 1998, 1999, 2000 Thai Open Source Software Center Ltd and Clark Cooper
Copyright (c) 2001, 2002, 2003, 2004, 2005, 2006 Expat maintainers.

libffi6
Copyright (c) 1996-2012 Anthony Green, Red Hat, Inc. and others.

libflac8
Copyright (C) 2000,2001,2002 Free Software Foundation, Inc.
51 Franklin St, Fifth Floor, Boston, MA 02111-1301 USA

Copyright (c) 2000-2009 Josh Cooleston
Copyright (C) 2011-2013 Xiph.Org Foundation

libformw5
Copyright (c) 1998-2004,2006 Free Software Foundation, Inc.

libfreetype6
Copyright 2005-2010, 2013 by David Turner, Robert Wilhelm, and Werner Lemberg.

libglib-2.0-0
pcrc : Copyright (c) 1997-2012 University of Cambridge

libjpeg8
Independent JPEG Group's JPEG software
copyright (C) 1991-2012, Thomas G. Lane, Guido Vollbrecht.

liblog4cplus-1.9
Copyright (C) 1999-2009 Contributors to log4cplus project. All rights reserved.

libmenuw5
Copyright (c) 1998-2004,2006 Free Software Foundation, Inc.

libncursesw5
Copyright (c) 1998-2004,2006 Free Software Foundation, Inc.

libogg0
Copyright (c) 2002, Xiph.org Foundation

libopus0
Copyright 2001-2011 Xiph.Org, Skype Limited, Octasic, Jean-Marc Valin, Timothy B. Terriberry, CSIRO, Gregor Maxwell, Mark Borgerding, Erik de Castro Lopo

liborc-0.4-0
ORC - The ORC Runtime Compiler
Copyright 2002 - 2009 David A. Schleeff <ds@schleeff.org>

Copyright (C) 1997 - 2002, Makoto Matsumoto and Takuji Nishimura

libpanelw5
Copyright (c) 1998-2004,2006 Free Software Foundation, Inc.

libpopit0
Copyright (c) 1998 Red Hat Software

libssl1.0.0
Copyright (c) 1998-2011 The OpenSSL Project. All rights reserved.

libtinfo5
Copyright (c) 1998-2004,2006 Free Software Foundation, Inc.

libuuid1
Copyright (C) 1996, 1997, 1998, 1999 Theodore Ts'o

libvorbis
Copyright (c) 2002-2008 Xiph.org Foundation

libx11-6
Copyright (C) 2003-2006,2008 Jamey Sharp, Josh Triplett
Copyright © 2009 Red Hat, Inc.
Copyright 1989-1992,1998,2000,2004,2009,2010 Oracle and/or its affiliates.
All rights reserved.

libxau6
Copyright 1988, 1993, 1994, 1998 The Open Group

libxcb1
Copyright (C) 2001-2006 Bart Massey, Jamey Sharp, and Josh Triplett. All Rights Reserved.

libxdmcp6
Copyright 1989, 1998 The Open Group

libxmi2
Copyright (C) 1998-2012 Daniel Veillard.

nanoms9
Achille Roussel <ach@fb.com> Aleksandar Fabijanic <alex@pocoproject.org>
Alex Brem <alex@flukuation.net> Andre Jonsson <andre.jonsson@datacluctus.se>
Andrew Starks <andrew.starks@trms.com> Aram Santogitis <aram.santogitis@cern.ch>
Ark Degtiarov <a@amcloud.co> Bill McCroskey <Bill.McCroskey@Crown.com>
Bruno Zentner <bz@bz.de> Bruce Mitchener <bruce.mitchener@gmail.com>
Bruno Bigras <bruno@bruno.com> Chip Salzenberg <chip@pobox.com>
David Beck <dbeck@beckground.hu> Dirkjan Ochtman <dirkjan@ochtman.nl>
Dong Fang <yf.fangdong@gmail.com> Drew Crawford <drew@sealedabstract.com>
Dylan Socolobsky <dacolobsky@gmail.com>
Emers Chevalier <emerschevalier.pro@gmail.com>
Emil Renner Berthing <esmil@maillie.dk> Evan Wies <evan@neomantra.net>
Garrett Roberts <garrett@damore.org> Garrett D'Amore <garrett@damore.org>
Gonzalo Diethelm <gonzalo.diethelm@diethelm.org>
Gaurav Gupta <g.gupta@samsung.com> Hajime Saito <emijah.s@gmail.com>
Harlan Lieberman-Berg <H.LiebermanBerg@gmail.com>
Immanuel Weber <immanuel.weber@frhitransfer.de>
Ivan Pechorin <ivan.pechorin@gmail.com> Joshua Foster <jhawk28@gmail.com>
Julien Ammous <schmurty@gmail.com> Kaspar Schiess <kaspar.schiess@absurd.li>
Kristian Lein-Mathisen <kristianleim@gmail.com> Luca Barbato <luca.barbato@gmail.com>
Manuel Mendez <mmendez34@gmail.com> Mark Eitzert <socket@gmail.com>
Martin Sustrik <sustrik@250bpm.com> Matt Howlett <matt.howlett@gmail.com>
Max Drechsler <max.drechsler@web.de> Michael John <gosh.mike@gmail.com>
Mikko Koppanen <mikko@kuori.fi> Nick Desaulniers <nicksaulniers@mozilla.com>
Nicolas Hillegeer <nicolashillegeer@gmail.com> Nir Soffer <nirsof@gmail.com>
Orjan Persson <o@42mm.org> Oskari Timperi <oskari.timperi@iki.fi>
Paul Colomiets <paul@colomiets.name> Pavlo Kapyshin <@93z.org>
Remy Bruno <remy.bruno@trmiov.com> Rob Souk <rob@controlz.com>
Ryan Killea <ryanbaylorkillea@wpi.edu> Robert G. Jakabosky <tobby@sharerealm.com>
Sergey Avseyev <sergey.avseyev@gmail.com> Sergey Kovalevich <imndie@gmail.com>
Sergei Nikulov <sergei.nikulov@mail.com> Simon Strangetsaard <simon@roots.dk>
Stan Mihai <stanmihai@gmail.com> Steve McKay <shubalubdub@gmail.com>
Timothee Besset <timo@tmo.net> Tobias Peters <tobias.peters@kreativeffekt.at>
Victor Guerra <vguerra@gmail.com> Yonggang Luo <luoyonggang@gmail.com>
Zoltan Boszormenyi <boszzo@pr.hu>

ncurses-terminfo-base
Copyright (c) 1998-2004,2006 Free Software Foundation, Inc.

openssl-conf
Copyright (c) 1998-2011 The OpenSSL Project. All rights reserved.

shadow
Copyright (c) 1990 - 1994, Julianne Frances Haugh
Copyright (c) 1996 - 2001, Marek Michalkiewicz
Copyright (c) 2001 - 2006, Tomasz Kloczko
Copyright (c) 2007 - 2009, Nicolas Francois

sudo
Copyright (c) 2009-2013 Todd C. Miller <Todd.Miller@courtesan.com>

wpa-suplicant-ctrl
Copyright (c) 2002-2014, Jouni Malinen <j@w1.fi> and contributors
All Rights Reserved.

wpa-suplicant-passphrase

Copyright (c) 2002-2014, Jouni Malinen <j@w1.fi> and contributors
All Rights Reserved.

wpa-suplicant
Copyright (c) 2002-2014, Jouni Malinen <j@w1.fi> and contributors
All Rights Reserved.

boost
Copyright © 2008 Beman Dawes, Rene Rivera

iperf-2.0.5
Copyright (c) 1999-2007, The Board of Trustees of the University of Illinois
All Rights Reserved.

thttpd
Copyright © 1995, 1998, 1999, 2000, 2001 by Jef Poskanzer <jef@mail.acme.com>

Expat
Copyright (c) 1998, 1999, 2000 Thai Open Source Software Center Ltd.

FastDelegate
Copyright © CodeProject, 1999-2015
All Rights Reserved.

libogg
Copyright (c) 2002, Xiph.org Foundation

Tremolo
Copyright (C) 2002-2009 Xiph.org Foundation
Changes Copyright (C) 2009-2010 Robin Watts for Pinknoise Productions Ltd

Tremor
Copyright (c) 2002, Xiph.org Foundation

Mersenne Twister
Copyright (C) 1997 - 2002, Makoto Matsumoto and Takuji Nishimura, All rights reserved.

zlib
Copyright notice: (C) 1995-2013 Jean-loup Gailly and Mark Adler

c-ares
Copyright 1998 by the Massachusetts Institute of Technology.

mDNSResponder
Copyright (c) 2002-2006 Apple Computer, Inc

GladmanAES
Copyright (c) 1998-2010, Brian Gladman, Worcester, UK

Curve25519
Copyright 2008, Google Inc

You may obtain a complete machine-readable copy of the corresponding source code on a physical medium by contacting Customer Service.

This offer is valid to any third party within three years after last shipment of the product. Costs of physical distribution will be charged.

コールセンターにお問い合わせいただければ、対応するソースコードの完全な機械可読コピーを物理メディアでお渡しします。

製品の最終出荷後、3年間有効です。掛かる費用についてはご負担いただきます。

ONKYO

1-10-5 Yokoami, Sumida-ku, Tokyo 130-0015 JAPAN

<http://www.onkyo.com/>

<U.S.A.>

18 Park Way, Upper Saddle River, N.J. 07458, U.S.A.

For Dealer, Service, Order and all other Business Inquiries:

Tel: 201-785-2600 Fax: 201-785-2650

<http://www.us.onkyo.com/>

For Product Support Team Only:

1-800-229-1687

<http://www.us.onkyo.com/>

<Germany>

Gutenbergstrasse 3, 82178 Puchheim, Germany

Tel: +49-8142-4401-0 Fax: +49-8142-4208-213

<http://www.eu.onkyo.com/>

<UK>

Anteros Building, Odyssey Business Park, West End Road, South Ruislip, Middlesex, HA4 6QQ United Kingdom

Tel: +44 (0)871-200-1996 Fax: +44 (0)871-200-1995

<Hong Kong>

Unit 1033, 10/F, Star House, No 3, Salisbury Road, Tsim Sha Tsui Kowloon, Hong Kong.

Tel: +852-2429-3118 Fax: +852-2428-9039

<http://www.hk.onkyo.com/>

<PRC>

302, Building 1, 20 North Chaling Rd., Xuhui District, Shanghai, China 200032,

Tel: +86-21-52131366 Fax: +86-21-52130396

<http://www.cn.onkyo.com/>

<Asia, Oceania, Middle East, Africa>

Please contact an Onkyo distributor referring to Onkyo SUPPORT site.

<http://www.intl.onkyo.com/support/>

The above-mentioned information is subject to change without prior notice.

Visit the Onkyo web site for the latest update.

(C) Copyright 2016 Onkyo & Pioneer Corporation Japan. All rights reserved.

Onkyo group has established its Privacy Policy, available at [<http://www.onkyo.com/privacy/>].

Printed in Malaysia / Imprimé en Malaisie / Напечатано в Малайзии

SN 29402579D

F1911-4



* 2 9 4 0 2 5 7 9 D *