



NETWORK AUDIO PLAYER

NS-6170

Instruction Manual

Before Start

What's in the box 2

Part Names

Front Panel 3

Rear Panel 4

Remote Controller 5

Display 6

Install

Connections with an amplifier 7

Connecting the antenna/power cord, etc. 9

Initial Setup

Power On & Initial Setup 10

Playback

USB Storage Device/HDD 12

Internet Radio 14

Spotify 15

Listening to the FM Radio 16

Listening to DAB Digital Radio 18

AirPlay® 19

Music Server 20

Entering text 22

Supplementary information

Supplementary information for player functions 23

Advanced Setup

Advanced Settings..... 24

Firmware Update 28

Others

Troubleshooting 30

General Specifications 32

License and Trademark Information 33



What's in the box

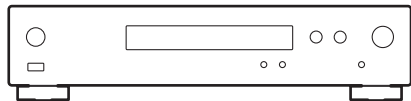

Main unit (1)

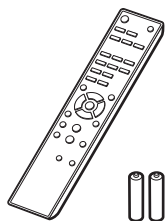

Remote controller (RC-943E) (1), Batteries (AAA/R03) (2)

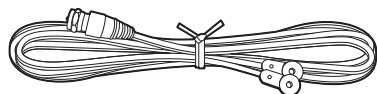

DAB/FM wire antenna (1)

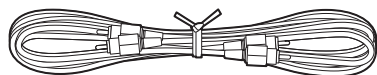

Analog audio cable (1)

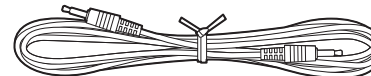

RI cable (1)

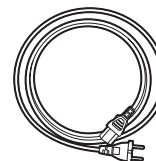

Power cord (1)



- The power cord must be connected only after all other cable connections are completed.
- We will not accept responsibility for damage arising from the connection of equipment manufactured by other companies.
- Functionality may be introduced by firmware updates and service providers may cease services, meaning that some network services and content may become unavailable in the future.
- Specifications and appearance are subject to change without prior notice.

Front Panel

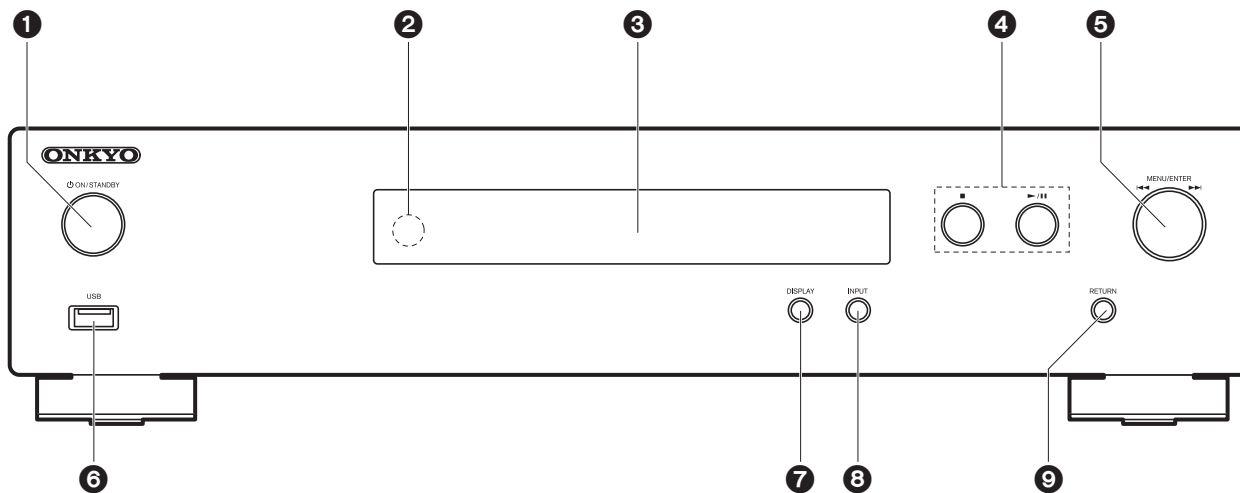

1. **⏻** ON/STANDBY button: Turns the unit on or to standby mode.
2. Remote control sensor
3. Display (→P6)
4. Play button:
 - : This button stops playback.
 - ▶/|| : Play or pause play.
5. MENU/ENTER dial (◀◀/▶▶)

When playing, turn left or right to select the folder or file, then press to confirm.
Press and hold to show the settings screen. While the menu is displayed, turn the dial to select items and press to confirm the settings.

 - Depending on the input, the operation may not start.
6. USB port: Connect a USB storage device or HDD (hard disk drive) to play music files. You can also supply power (maximum 5 V/0.5 A) to USB devices with a USB cable.
 - When connecting a HDD that requires more than 5 V/0.5 A, connect to the USB port (maximum 5 V/1 A) on the rear of the unit.

7. DISPLAY button: Switches the information on the display.
8. INPUT button: Switches the input to be played.
9. RETURN button: Returns to the previous screen.



Rear Panel

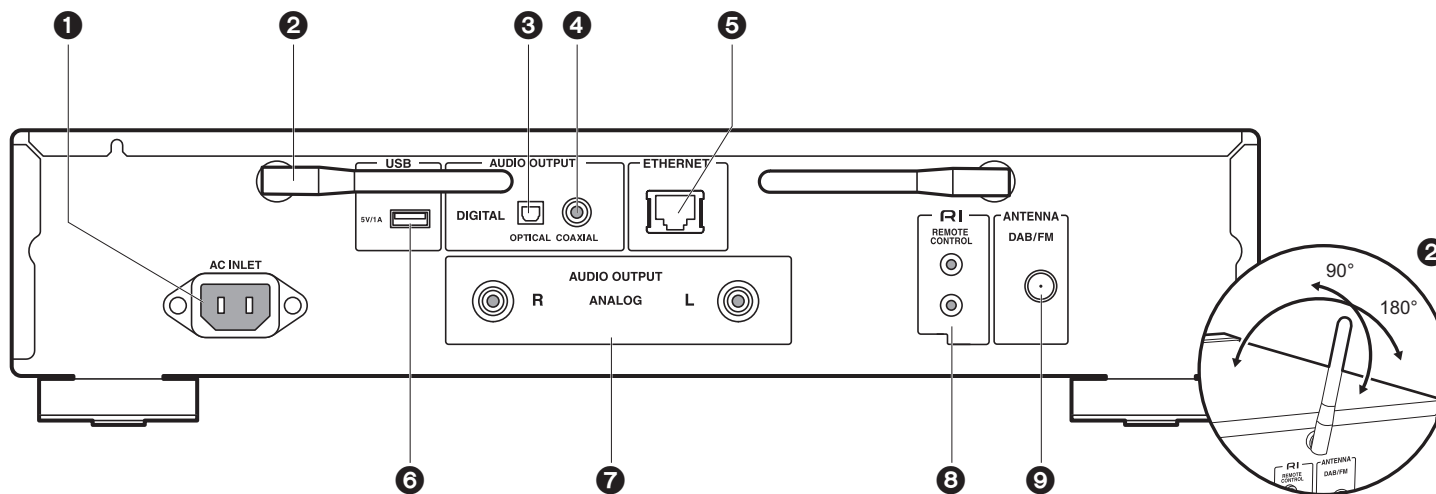

1. AC INLET: Connect the supplied power cord.
2. Wireless antenna: Used for Wi-Fi connection. Adjust their angles according to the connection status.
3. AUDIO OUTPUT DIGITAL OPTICAL jack: Connect a pre-main amplifier with digital optical cable.
4. AUDIO OUTPUT DIGITAL COAXIAL jack: Connect a pre-main amplifier with digital coaxial cable.
5. ETHERNET jack: Connect to the network with an ethernet cable.
6. USB port: Connect a USB storage device or HDD (hard disk drive) to play music files. You can also supply power (maximum 5 V/1 A) to USB devices with a USB cable.
7. AUDIO OUTPUT ANALOG jacks: Connect a pre-main amplifier with the included analog audio cable.
8. **RI** REMOTE CONTROL jack: Connect an Onkyo product with an RI jack using the included RI cable to synchronized with this unit. (→P8)
9. ANTENNA DAB/FM jack: Connect the included DAB/FM wire antenna.



Remote Controller

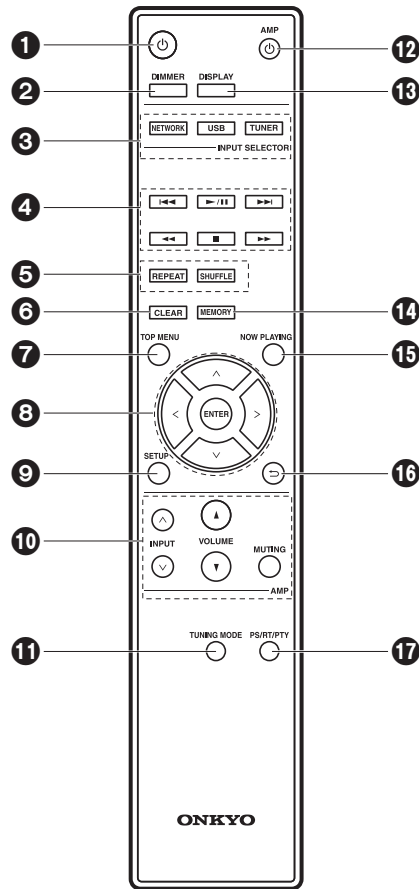

1. button: Turns the unit on or into standby mode.
2. DIMMER button: Switch the display off or adjust the brightness of the display in two steps.
3. INPUT SELECTOR buttons: Switches the input to be played.
4. Play buttons:
 - : Move to the track before the one being played. (USB, Music Server)
Used to select stations that have been registered or to give names to stations. (FM)
 - : Play or pause play.
 - : Move to the next track. (USB, Music Server)
Used to select stations that have been registered or to give names to stations. (FM)
 - : Used to select radio stations. (FM)
 - : Stop playback.
 - Depending on the input, the operation may not start.
5. REPEAT button: Set repeat play.
6. SHUFFLE button: Set shuffle play.
7. CLEAR button: Used when entering text, etc
8. TOP MENU button: Move to the top menu of the selected input.
9. CURSORS, ENTER button: Select the item with the cursors and press ENTER to confirm.
10. SETUP button: Displays the setup menu.
11. Amplifier control buttons
 - Use to switch the input, adjust the volume, etc., of an Onkyo pre-main amplifier.
 - Operation may not be possible with some amplifiers.
12. TUNING MODE button: Switches tuning to an FM station between automatic tuning and manual tuning.
13. AMP button: Switch an Onkyo pre-main amplifier between on and standby.
 - Operation may not be possible with some amplifiers.
14. DISPLAY button: Switches the information on the display.
15. MEMORY button: Used to register FM radio stations.
16. NOW PLAYING button: When you have changed the display during play, for example, this button returns the display to show information about the file being played.
17. button: Returns the display to the previous state.
18. PS/RT/PTY button: Can be used when receiving the station transmitting text information.

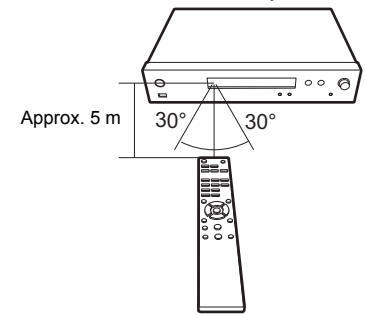

E N



Display

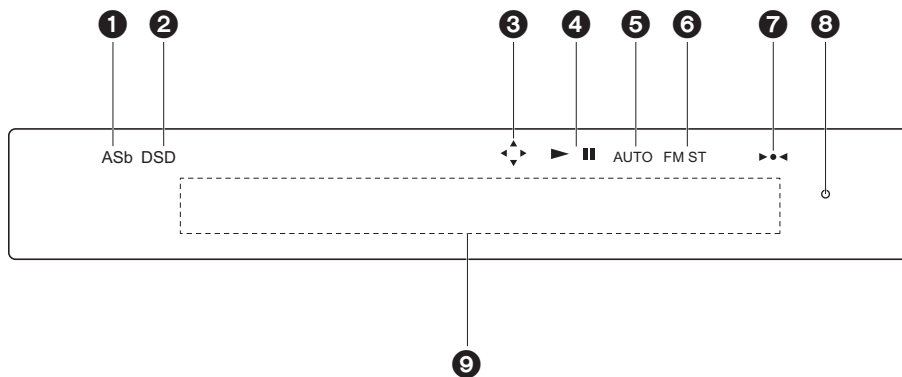

EN

1. ASb: Lights when "Auto Standby" (→P25) is set to "On".
2. DSD: Lights when the audio signal being input is DSD.
3. Lights when remote controller cursor operations are possible.
4. Displays the play status.
5. Lights when automatic tuning is selected as the method for tuning radio stations.
6. Lights when FM stereo is being received.
7. Lights when tuned into a radio station.
8. DIMMER indicator: Lights when you have pressed DIMMER to turn the display off.
9. Message display: Displays information about tracks and menus.
 - Characters that cannot be displayed on this unit are replaced with asterisks (*).
 - The following icons are displayed.
 - : Folder
 - : Track title
 - : Playing
 - : Paused
 - : Artist
 - : Album
 - : 1-track repeat

- : Repeat within a folder
- : Shuffle

- When DIMMER is pressed to turn off the display, the unit may appear the same as if you had unplugged the unit from the power outlet, but electricity is still being supplied to the unit. To completely cut the unit off from the power supply, you need to unplug the power plug (shutoff device) unit from the power outlet.



Connections with an amplifier

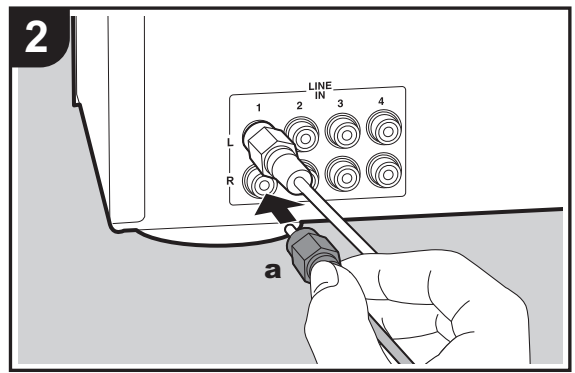
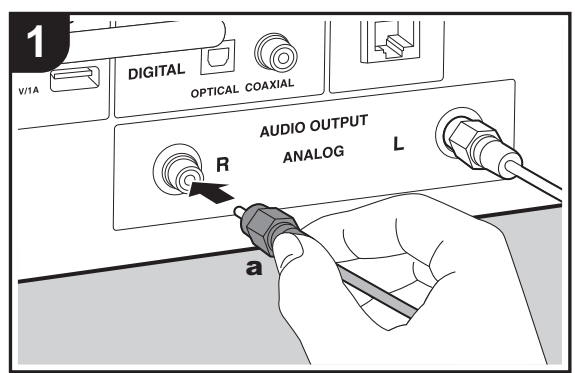

NS-6170

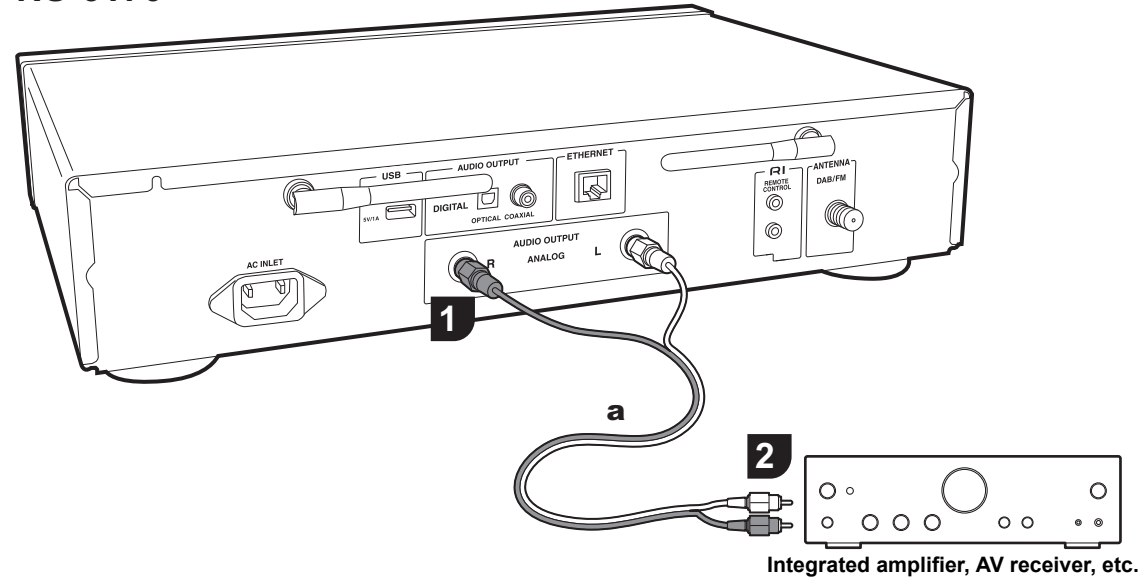

You can play the audio from network features such as internet radio through speaker systems connected to pre-main amplifiers or AV receivers. Connect to suit the input jacks on your amplifier.

Connecting with an analog audio cable

The signal is converted to analog in the D/A converter of this unit and then output to the pre-main amplifier. Connect the LINE IN jacks on a pre-main amplifier with the included analog audio cable to the AUDIO OUTPUT ANALOG jack on this unit.

Connecting with a digital optical cable

The signal is converted to analog in the D/A converter of the pre-main amplifier. Connect the OPTICAL IN jacks on a pre-main amplifier with a digital optical cable to the AUDIO OUTPUT DIGITAL OPTICAL jack on this unit.

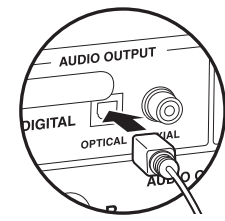

a Analog audio cable



Connecting with a digital coaxial cable

The signal is converted to analog in the D/A converter of the pre-main amplifier. Connect the COAXIAL IN jacks on a pre-main amplifier with a digital coaxial cable to the AUDIO OUTPUT DIGITAL COAXIAL jack on this unit.

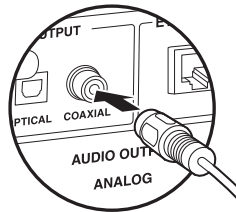

Connecting with Onkyo RI Components

By connecting an Onkyo component with RI jack to the unit by using an optional RI cable and an analog audio cable, you can link the unit's power and input selection and enable operation with this unit's remote controller. For details, refer to the instruction manual of the component with the RI jack.

- Some components may not support all RI functions.

NS-6170

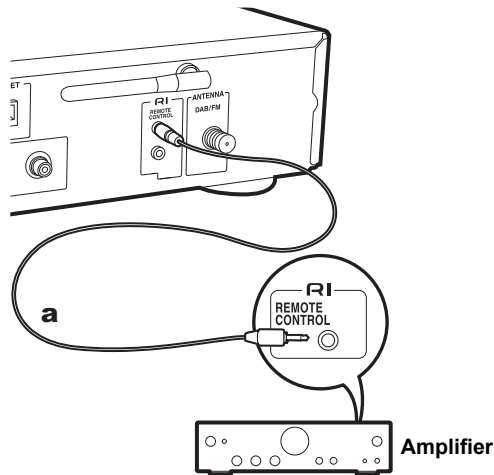

a RI cable



Connecting the antenna/power cord, etc.

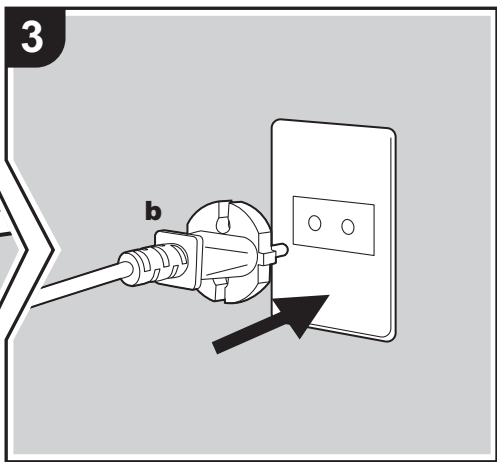
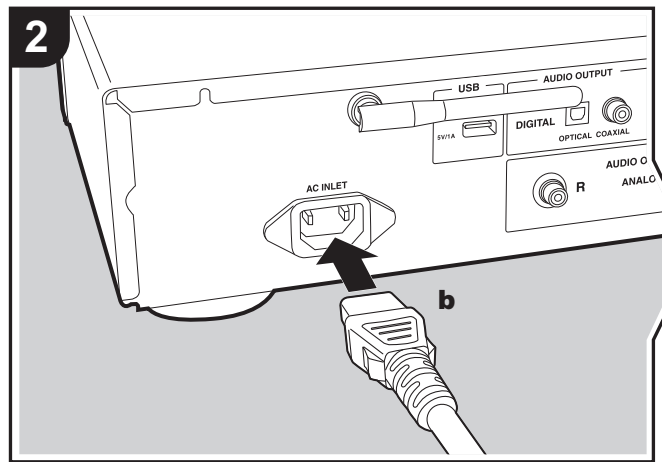
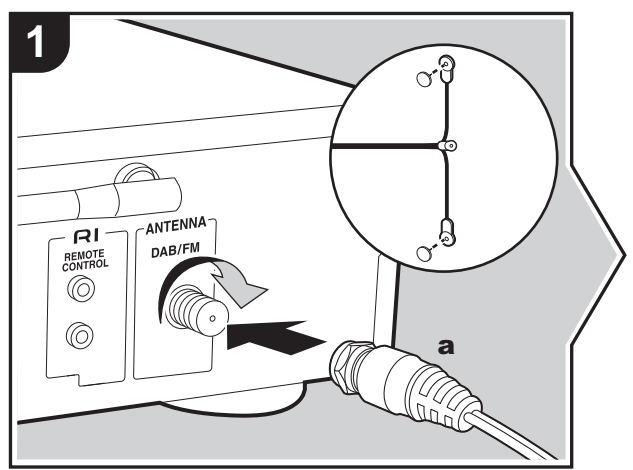

a DAB/FM wire antenna, **b** Power cord

Antenna Hookup

Move the antenna around while playing the radio to find the position with the best reception.

Power cord connection

This model includes a removable power cord. The power cord must be connected only after all other connections are completed. Make sure you first connect the power cord to AC INLET terminal of the unit and then connect to the outlet. Always disconnect the outlet side first when disconnecting the power cord.

Ethernet cable connection

To connect to the network with an ethernet cable, use the ETHERNET jack. When using Wi-Fi connection, make settings in initial settings (→P10). You can enjoy features such as internet radio and AirPlay by connecting to the network.

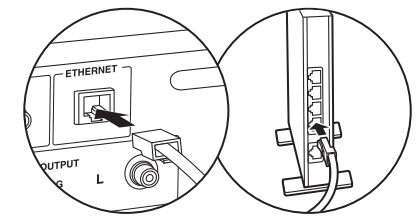

EN



Power On & Initial Setup

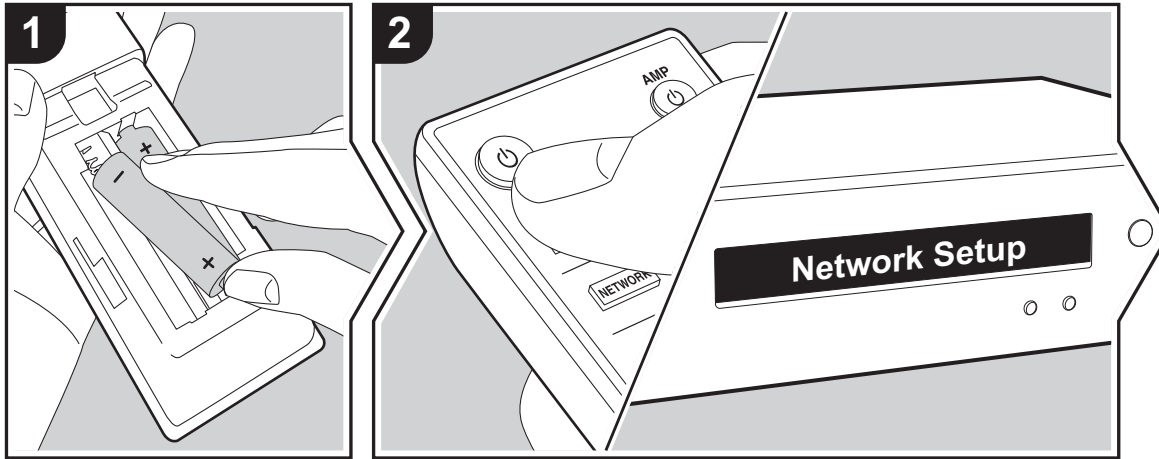

Starting up: When you press , "Now Initializing..." is displayed on the display. After this, when "Now Initializing..." goes out, you can start operating the unit.



Wi-Fi connection settings

When you first turn the power on, the Network Setup screen is displayed automatically, allowing you to easily make Wi-Fi connection settings.

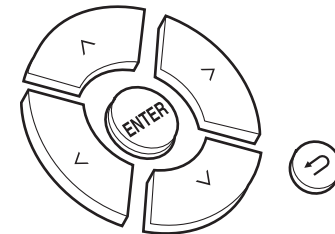

To set, select the item with the cursors on the remote controller and press ENTER to confirm.



- To return to the previous display, press .
 - Turn MENU/ENTER on the main unit to the left and right to select the item, then press the dial to confirm.
1. Press ENTER when "Network Setup" is displayed.
 2. To make Wi-Fi settings, select "Wi-Fi". If you have connected with an ethernet cable, select "Wired(Exit)" with  on the remote controller and press ENTER.

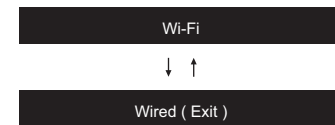

3. If you selected "Wi-Fi", select the setting method with .



∨ on the remote controller and press ENTER.

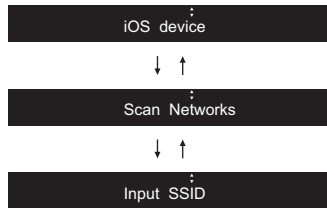

- To redo the initial settings, press SETUP on the remote controller, select "Wi-Fi" in "Network" - "Connection", then select "Wi-Fi Setup".

■ iOS device

Set by sharing the iOS device's Wi-Fi settings with this unit.

1. Connect the iOS device by Wi-Fi.
2. Select this device in the "SET UP NEW AIRPLAY SPEAKER..." item on the screen of the iOS device and select "Next".
 - This unit is displayed as "Onkyo NS-6170 XXXXXX".
3. After "Check Network" is displayed on this unit, when the Wi-Fi settings are complete, the display changes. Select "Done" on the screen of the iOS device.

■ Scan Networks

From the list of SSID for access points such as wireless LAN routers, select the required SSID and make the settings.

1. Select the SSID of the access point you want to connect with ^/∨ on the remote controller and press ENTER.

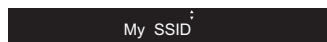

2. Select "Password" or "Push Button" with ^/∨ on the remote controller and press ENTER. If the access point has an automatic connection button, by selecting "Push Button" you can connect without entering a password.

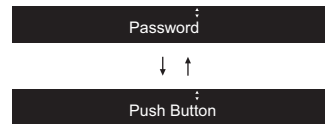

3. If you select "Password", enter the password of the access point. For details on how to enter text, refer to "Entering text" (➔P22).
If you select "Push Button", then after pressing and holding the automatic setting button on the access point for the required amount of time, press ENTER on the remote controller.
4. After "Check Network" is displayed, the information of the display switches when the Wi-Fi settings are complete.
 - If "Retry" appears on the display, press ENTER to retry the settings.

■ Enter SSID of the access point

Set by entering the SSID of the access point you want to connect.

1. Enter the SSID. For details on how to enter text, refer to "Entering text" (➔P22).
2. Select the authentication method with ^/∨ on the remote controller and press ENTER.



- If you select "None", proceed to step 3. If you select

"WEP", "WPA", or "WPA2", enter the password and confirm.

3. After "Check Network" is displayed, the information of the display switches when the Wi-Fi settings are complete.
 - If "Retry" appears on the display, press ENTER to retry the settings.

EN



USB Storage Device/HDD

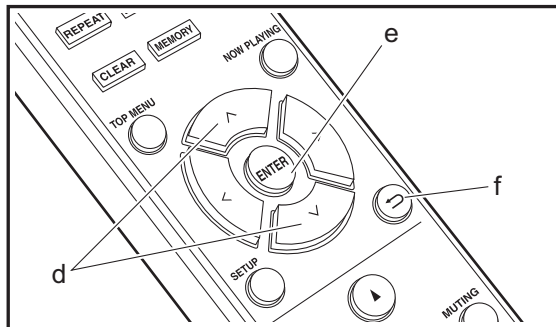
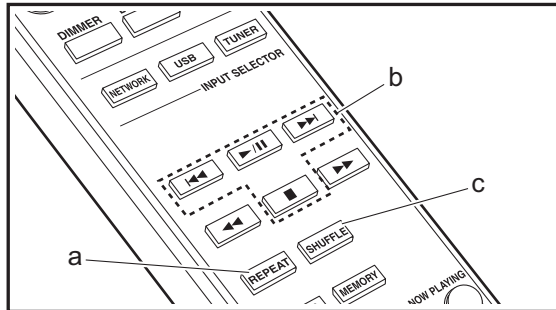
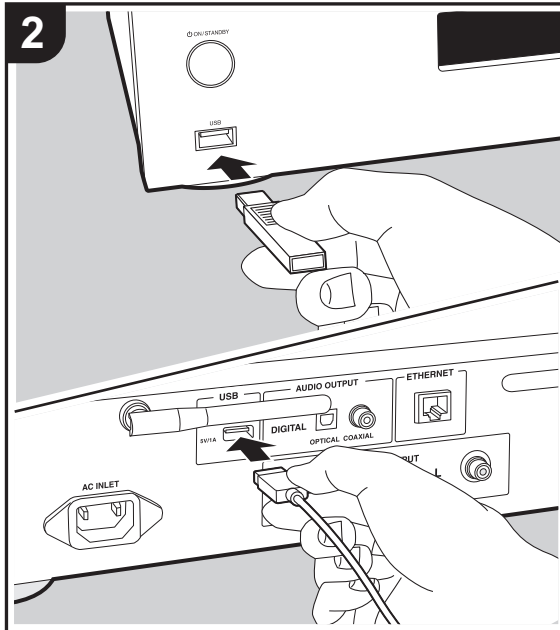
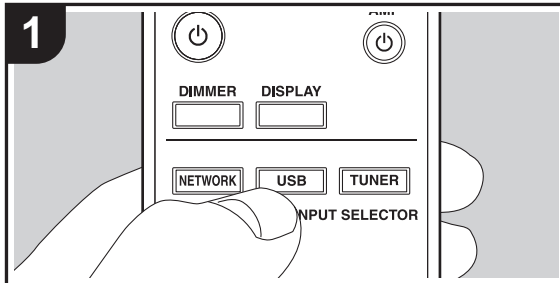

Basic operations

You can play music files by connecting a USB storage device or HDD (hard disk drive) to the USB port on the front or rear of the unit.

- The USB port on the front supports a maximum 5 V/0.5 A power supply. If the HDD requires more than this, connect to the USB port (maximum 5 V/1 A) on the rear of the unit.
1. Turn the unit on.
 2. Press USB to select "USB (F)" (USB port on the front panel) or "USB (R)" (USB port on the rear panel).

USB (F)

3. Plug your USB storage device or HDD into the USB port on the front or rear.
4. Press ENTER (e) after reading is complete.
5. Select the folder or music file with ^/∨ (d) on the remote controller and press ENTER (e) to confirm. To return to the previous display, press ⏪ (f).
6. Use play buttons (b) to stop play or choose tracks to play.
 - The display of album name and artist name is supported with MP3/WMA/Apple Lossless/FLAC/AAC/DSD (DSF only) format music files.
 - Characters that cannot be displayed by this unit appear as "*".
 - The USB port of this unit conforms with the USB 2.0 standard. The transfer speed may be insufficient for some content you play, which may cause some interruption in sound.

Repeat play

1. Repeatedly press REPEAT (a) during play to display
 - ⏮ or ⏭ on the display.
 - ⏮: Repeat play of the selected individual track.
 - ⏭: Repeat play of all tracks within a folder.
 To cancel repeat play, press REPEAT (a) several times

EN



until the icons disappear.

Shuffle play

1. Press SHUFFLE (c) during play to display on the display.
: Play tracks in a folder randomly.
 To cancel shuffle play, press SHUFFLE (c) until the icon disappears.

USB Storage / HDD Device Requirements

- Note that operation is not guaranteed with all USB storage devices or HDD.
- This unit can use USB storage devices that comply with the USB mass storage device class standard. (However, there are still devices that cannot be played by this unit even if they comply with the USB mass storage class standard.)
- The unit is also compatible with USB storage devices using the FAT16 or FAT32 file system formats. Other formats such as exFAT, NTFS, and HFS cannot be played by this unit.
- If the USB storage device has been partitioned, each section will be treated as an independent device.
- Up to 20,000 tracks per folder can be displayed, and folders may be nested up to 16 levels deep.
- USB hubs and USB storage devices with hub functions are not supported. Do not connect these devices to the unit.
- USB storage devices with security function are not supported on this unit.
- If the USB storage device or HDD comes with an AC adapter, we recommend that you use its AC adapter to power it.
- Media inserted to the USB card reader may not be available in this function. Furthermore, depending on the USB storage device, proper reading of the contents may

not be possible.

- We accept no responsibility whatsoever for the loss or damage to data stored on a USB storage device when that device is used with this unit. We recommend that you back up your important music files beforehand.

Supported Audio Formats

For server playback and playback from a USB storage device, this unit supports the following music file formats. Note that sound files that are protected by copyright cannot be played on this unit.

MP3 (.mp3/.MP3):

- Supported formats: MPEG-1/MPEG-2 Audio Layer 3
- Supported sampling rates: 44.1 kHz, 48 kHz
- Supported bitrates: Between 8 kbps and 320 kbps and VBR.

WMA (.wma/.WMA):

- Supported sampling rates: 44.1 kHz, 48 kHz
- Supported bitrates: Between 5 kbps and 320 kbps and VBR.
- WMA Pro/Voice/WMA Lossless formats are not supported

WAV (.wav/.WAV):

WAV files include uncompressed PCM digital audio.

- Supported sampling rates: 44.1 kHz, 48 kHz, 88.2 kHz, 96 kHz, 176.4 kHz, 192 kHz
- Quantization bit: 8 bit, 16 bit, 24 bit

AIFF (.aiff/.aif/.aifc/.afc/.AIFF/.AIF/.AIFC/.AFC):

AIFF files include uncompressed PCM digital audio.

- Supported sampling rates: 44.1 kHz, 48 kHz, 88.2 kHz, 96 kHz, 176.4 kHz, 192 kHz
- Quantization bit: 8 bit, 16 bit, 24 bit

AAC (.aac/.m4a/.mp4/.3gp/.3g2/.AAC/.M4A/.MP4/.3GP/.3G2):

- Supported formats: MPEG-2/MPEG-4 Audio
- Supported sampling rates: 44.1 kHz, 48 kHz, 88.2 kHz, 96 kHz
- Supported bitrates: Between 8 kbps and 320 kbps and VBR.

FLAC (.flac/.FLAC):

- Supported sampling rates: 44.1 kHz, 48 kHz, 88.2 kHz, 96 kHz, 176.4 kHz, 192 kHz
- Quantization bit: 8 bit, 16 bit, 24 bit

Apple Lossless (.m4a/.mp4/.M4A/.MP4):

- Supported sampling rates: 44.1 kHz, 48 kHz, 88.2 kHz, 96 kHz, 176.4 kHz, 192 kHz
- Quantization bit: 16 bit, 24 bit

DSD (.dsf/.dff/.DSF/.DFF):

- Supported formats: DSF/DSDIFF
- Supported sampling rates: 2.8 MHz, 5.6 MHz, 11.2 MHz



Internet Radio

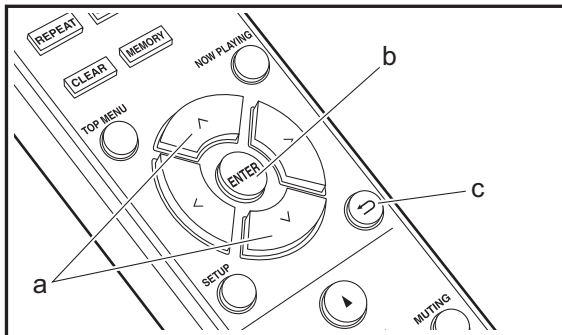
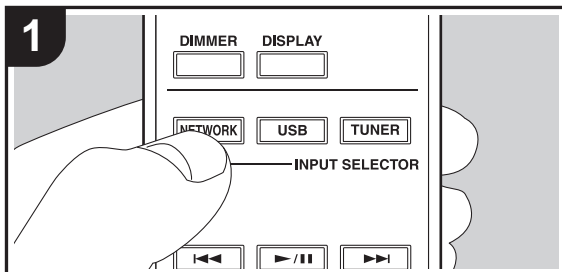

Basic operations

When this unit is connected to a network, you can listen to TuneIn or other preregistered Internet radio services. Depending on the internet radio service, the user may need to register from their computer first.

1. Turn the unit on.
2. Press NETWORK.
3. Select "TuneIn Radio", etc., with \wedge/\vee (a) of the remote controller and press ENTER (b) to confirm.

press ENTER (b).



- If "Connection Error." is displayed, check whether the network is properly connected.
4. Select the station, etc., with \wedge/\vee (a) on the remote controller and press ENTER (b). To return to the previous display, press \leftarrow (c).

TuneIn

You can register a station you have played as a favorite.

1. Press ENTER (b) while playing TuneIn.
2. Select "Add to My Presets" with \wedge/\vee (a) on the remote controller and press ENTER (b).
3. To play a favorite, select a registered station in "My Presets", displayed first when "TuneIn Radio" selected and press ENTER (b). To delete favorites, press ENTER (b) during play, select "Remove from My Presets" and



Spotify

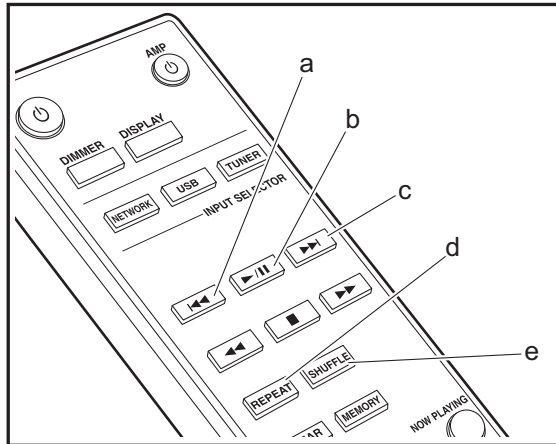
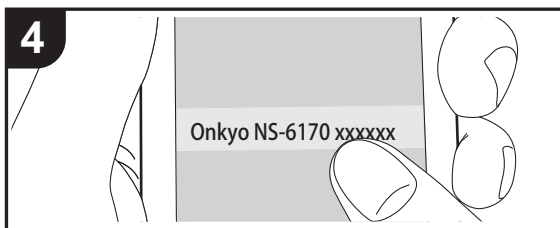
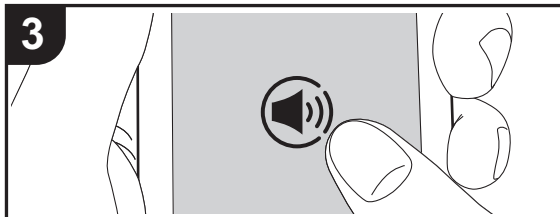
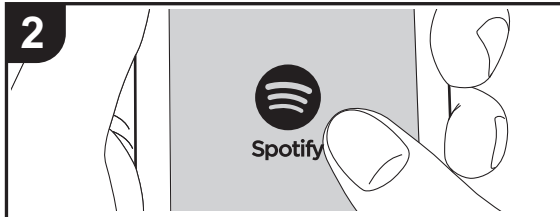
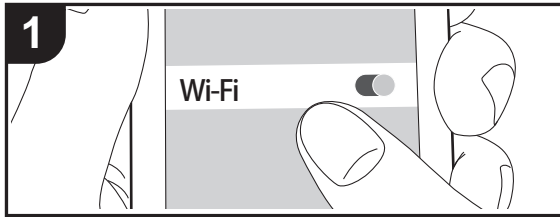

Basic Operation

Spotify Connect play is possible by connecting this unit to the same network as a smartphone or tablet. To enable Spotify Connect, install the Spotify application on your smartphone or tablet and create a Spotify premium account.

1. Connect the smartphone to the network that this unit is connected to.
 2. Click the Connect icon in the track play screen of the Spotify app.
 3. Select this unit.
 - This unit is displayed as "Onkyo NS-6170 XXXXXX".
 4. This unit turns on automatically and the input selector changes to NET and streaming of Spotify starts.
 - If "Option" - "PWR Setting" - "NET Stby" is set to "Off" in the setup menu, manually turn the unit on and then press NETWORK on the remote controller.
- Refer to the following for Spotify settings:
www.spotify.com/connect/
 The Spotify software is subject to third party licenses found here:
www.spotify.com/connect/third-party-licenses

The following remote controller operations are also possible.

- (a) This button plays the previous track.
- (b) Pressed during play this button pauses playback. Pressed while paused, and it restarts play.
- (c) This button plays the next track.
- (d) Start repeat play.
- (e) Start shuffle play.

EN



Listening to the FM Radio

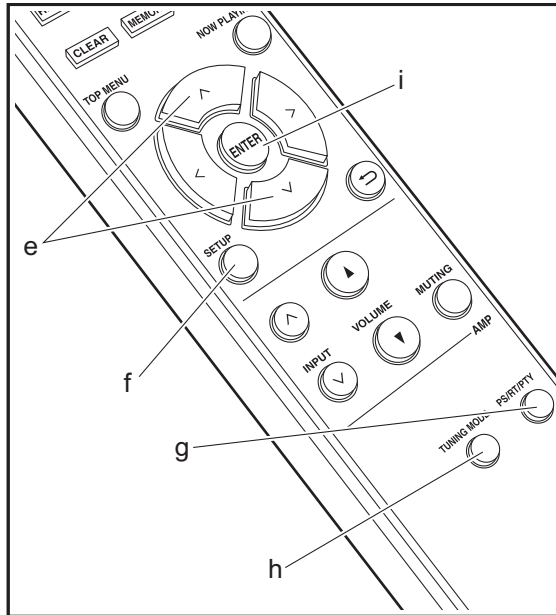
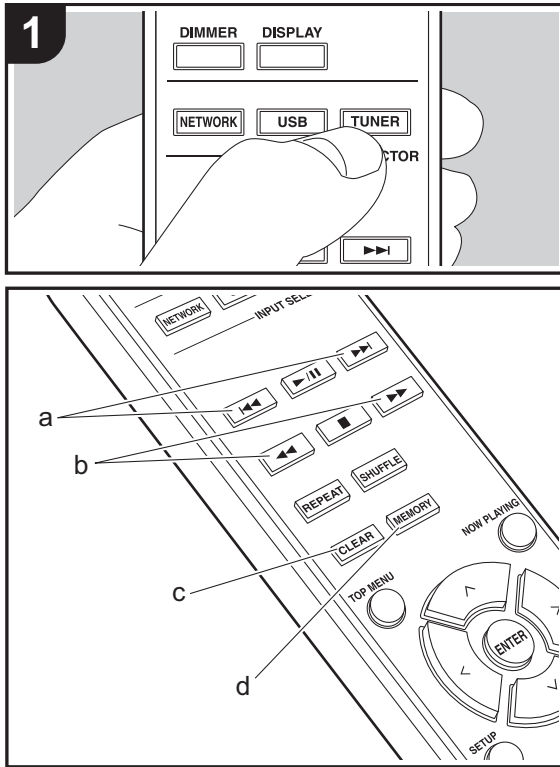

Tuning Automatically

1. Turn the unit on.
2. Repeatedly press TUNER to switch input to FM.



3. When you press ◀▶ (b) on the remote controller, automatic tuning starts, and searching stops when a station is found. "FM ST" indicator on the display lights when FM stereo station is being received.

When FM broadcasts are difficult to receive : Perform the procedure for "Tuning Manually". If you tune manually, the reception for FM broadcasts will be monaural rather than stereo, irrespective of the sensitivity of the reception.

Tuning Manually

1. Turn the unit on.
2. Repeatedly press TUNER to switch input to FM.
3. Press TUNING MODE (h) on the remote controller or MENU/ENTER dial on the main unit so that the "AUTO" indicator on the display goes off.
4. Select the station you want to listen to while pressing ◀▶ (b) on the remote controller.
 - The frequency changes by 1 step each time you press the button. The frequency changes continuously if the button is held down and stops when the button is released. Tune by looking at the display.

Registering a station

You can register a maximum of 40 stations.

1. Tune into the radio station you want to register.
2. Press MEMORY (d) on the remote controller so that the preset number on the display flashes.





- While the preset number is flashing (about 8 seconds), repeatedly press **◀◀/▶▶** (a) on the remote controller to select a number between 1 and 40.
- Press **MEMORY** (d) on the remote controller again to register the station. When registered, the preset number stops flashing.

Selecting registered stations

- Repeatedly press **TUNER** to switch input to FM.
- Press **◀◀/▶▶** (a) on the remote controller to select a preset number.

To delete a registered station

- Repeatedly press **TUNER** to switch input to FM.
- Press **◀◀/▶▶** (a) on the remote controller to select the preset number you want to delete.
- Press **CLEAR** (c) on the remote controller to delete the preset number.

To give a name to a registered station

- Repeatedly press **TUNER** to switch input to FM.
- Press **◀◀/▶▶** (a) on the remote controller to select a preset number.
- Press **SETUP** (f) on the remote controller.
- Press **^/∨** (e) on the remote controller to select "Option" - "Tuner Setting" - "NameEdit" and press **ENTER** (i).
- Enter a name for the station. For details on how to enter text, refer to "Entering text" (➔P22).

Using RDS

RDS stands for Radio Data System and is a method of transmitting data in FM radio signals. In regions using RDS, the radio station name is displayed when you tune into a radio station broadcasting program information. When you press **PS/RT/PTY** (g) on the remote controller in this state, you can use the following functions.

Displaying text information (Radio Text)

- While the name of the station is being displayed on the display, press **PS/RT/PTY** (g) on the remote controller once.
Radio Text (RT) broadcast by the station is displayed scrolling across the display. "No Text Data" is displayed when no text information is available.
 - Unusual characters may be displayed when the unit receives unsupported characters. However, this is not a malfunction. Also, if the signal from a station is weak, information may not be displayed.

Search for stations by Program Type

- While the name of the station is being displayed on the display, press **PS/RT/PTY** (g) on the remote controller twice.
- Press **◀◀/▶▶** (a) on the remote controller to select the Program Type you want to find, then press **ENTER** (i) to start the search.

The Program Types displayed are as follows:

- None
- News (News reports)
- Current affairs
- Information
- Sport
- Education
- Drama
- Cultures
- Science (Science and technology)
- Varied speech
- Pop music
- Rock music
- Easy listening
- Light classics m
- Serious classics
- Other music
- Weather & metr
- Finance
- Children's progs (Children's programmes)
- Social affairs

- Religion
- Phone in
- Travel & touring
- Leisure & hobby
- Jazz music
- Country music
- Nation music
- Oldies music
- Folk music
- Documentary

- The information displayed may sometimes not match the content being broadcast by the station.
- When a station is found, "FINISH" is displayed and the station flashes on the display. Press **ENTER** (i) while this is happening to start receiving that station. If you don't press **ENTER** (i), the unit continues to search for another station.
 - If no stations are found, the message "Not Found" is displayed.
 - Unusual characters may be displayed when the unit receives unsupported characters. However, this is not a malfunction. Also, if the signal from a station is weak, information may not be displayed.



Listening to DAB Digital Radio

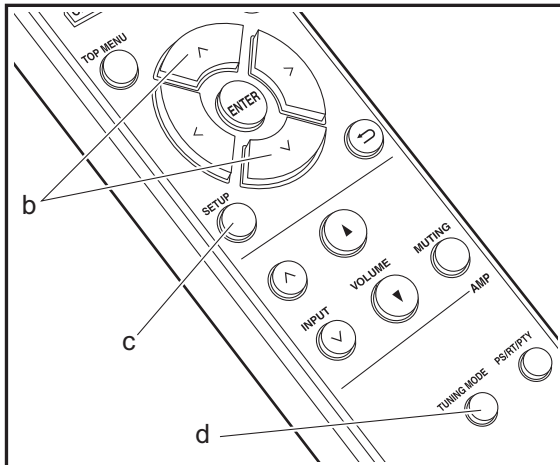
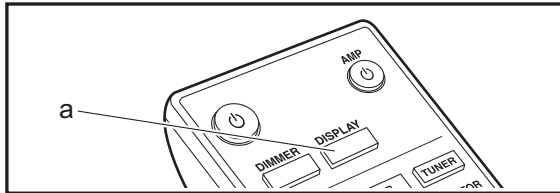
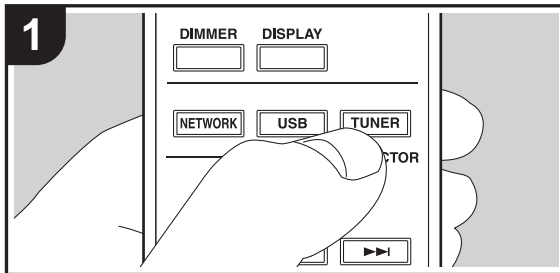

Tuning

1. Turn the unit on.
2. Repeatedly press TUNER to switch input to DAB.



- The very first time you select DAB, the Auto Tuning function automatically scans the DAB Band 3 for the multiplexes (i.e., stations) available in your area.



- Once the scanning process is complete, the first station that was detected is selected.
 - If a new DAB station is introduced, or you move to a new area, press SETUP (c) on the remote controller, then use "DAB Scan" in "Option" - "Tuner Setting".
3. Select the desired radio station with the cursors (b) on the remote controller.

Changing the order stations are displayed

You can sort the available stations alphabetically or by multiplex.

1. Press TUNING MODE (d) repeatedly to set the method for sorting the display order from the following.
 - Alphabet (default setting)** : Sort stations alphabetically.
 - Multiplex** : Sort stations by multiplex.

Displaying DAB Radio Information

1. Press the DISPLAY button (a) repeatedly to display more information about the selected DAB station.

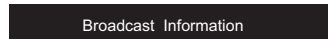

DLS (Dynamic Label Segment) : When tuned to a station that's broadcasting DLS text data, the text will

scroll across the display.

Program Type : Displays the type of program.

Bit Rate and Audio Mode : Displays the station's bit rate and audio mode (Stereo, Mono).

Quality : Displays the signal quality.

0 - 59: Poor reception

60 - 79: Good reception

80 - 100: Excellent reception

Multiplex Name : Displays the name of the current multiplex.

Multiplex Number and Frequency : Displays the number and frequency of the current multiplex.

E
N



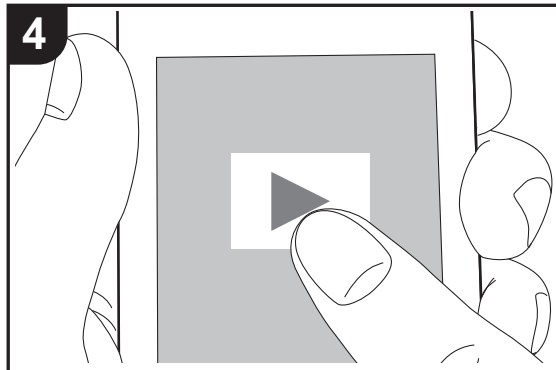
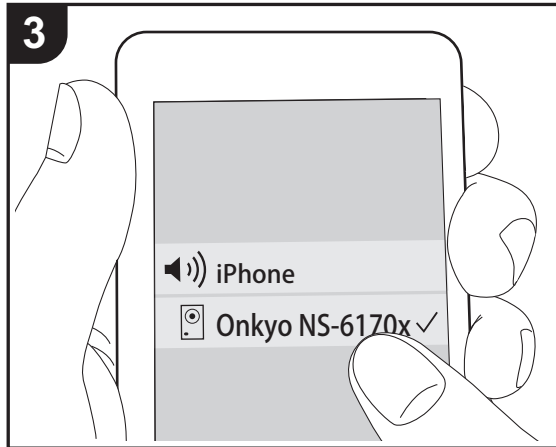
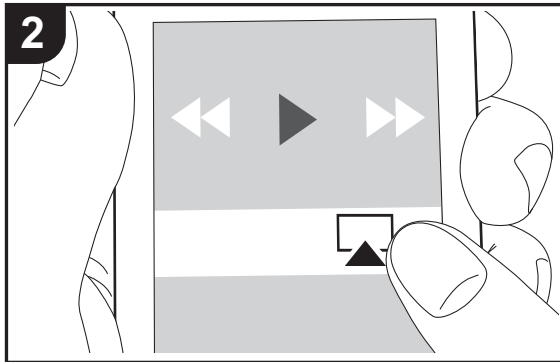
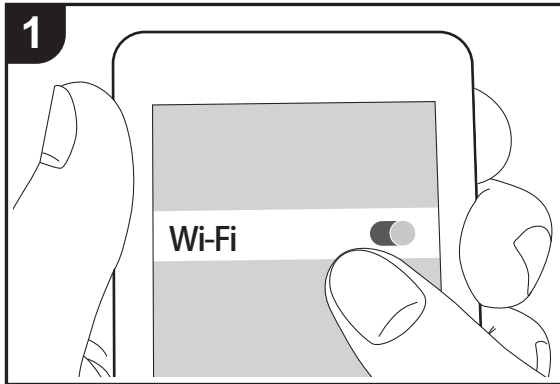

AirPlay®



Basic Operation

You can wirelessly enjoy the music files on an iPhone®, iPod touch®, or iPad® connected to the same access point as this unit. Update the OS version on your iOS device to the latest version.

1. Turn the unit on.
2. Connect the iOS device to the same network as this unit.
3. Tap the AirPlay icon  in the control center of the iOS device and select this unit from the list of devices displayed, and tap "Done".
 - This unit is displayed as "Onkyo NS-6170 XXXXXX".
 - If an "AirPlay PW" has been set on this unit, enter the password you set.
4. Play the music files on the iOS device.
 - In the setup menu displayed by pressing SETUP on the remote controller, when "Option" - "PWR Setting" - "NET Stby" is set to "On", when play of AirPlay starts, this unit turns on automatically and play starts.
 - Due to the characteristics of AirPlay wireless technology, the sound produced on this unit may slightly be behind the sound played on the AirPlay-enabled device.
 - SHUFFLE or REPEAT on the remote controller does not work. Operate from the iOS device.

You can also play the music files on a computer with iTunes (Ver. 10.2.2 or later). Make sure this unit and the computer are connected to the same network, click the AirPlay icon  in iTunes, select this unit from the list of devices displayed, and start play of a music file.

E
N



Music Server

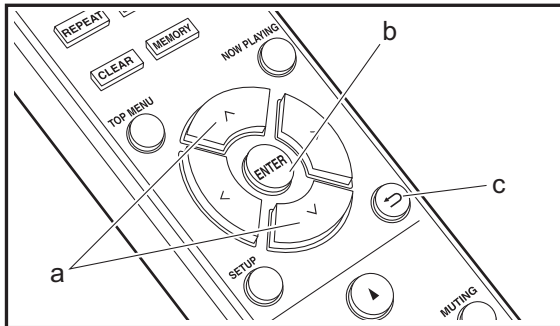
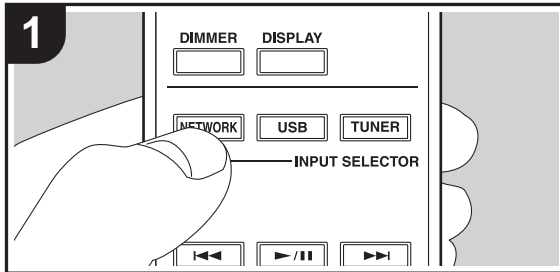

It is possible to stream music files stored on PCs or NAS devices connected to the same network as this unit. The network servers this unit is compatible with are those PCs with players installed that have the server functionality of Windows Media® Player 11 or 12, or NAS that are compatible with home network functionality. You may need to make some settings in advance to use Windows Media® Player 11 or 12. Note that only music files registered in the library of Windows Media® Player can be played.

there may be differences in the names of items you can select.

Configuring Windows Media® Player

■ Windows Media® Player 11

1. Turn on your PC and start Windows Media® Player 11.
2. In the "Library" menu, select "Media Sharing" to display a dialog box.
3. Select the "Share my media" check box, and then click "OK" to display the compatible devices.
4. Select this unit, and then click "Allow".
 - When it is clicked, the corresponding icon is checked.
5. Click "OK" to close the dialog.
 - Depending of the version of Windows Media® Player, there may be differences in the names of items you can select.

■ Windows Media® Player 12

1. Turn on your PC and start Windows Media® Player 12.
2. In the "Stream" menu, select "Turn on media streaming" to display a dialog box.
 - If media streaming is already turned on, select "More streaming options..." in the "Stream" menu to list players in the network, and then go to step 4.
3. Click "Turn on media streaming" to list players in the network.
4. Select this unit in "Media streaming options" and check that it is set to "Allow".
5. Click "OK" to close the dialog.
 - Depending of the version of Windows Media® Player,

Playing

1. Turn the unit on.
2. Start the server (Windows Media® Player 11, Windows Media® Player 12, or NAS device) containing the music files to play.
3. Make sure that the PCs and/or NASs are properly connected to the same network as this unit.
4. Press NETWORK.
5. Select "Music Server" with ^/∨ (a) on the remote controller and press ENTER (b).



6. Select the server and music file with ^/∨ (a) on the remote controller and press ENTER (b) to confirm. To return to the previous display, press ← (c).
 - If "Connection Error." is displayed, check whether the network is properly connected.
 - Depending on the server being used and the files played, elapsed play time and remaining play time may not be displayed.
 - For music files on a server, there can be up to 20,000 tracks per folder, and folders may be nested up to 16 levels deep.

Controlling Remote Playback from a PC

You can use this unit to play music files stored on your PC by operating the PC inside your home network. The unit supports remote playback with Windows Media® Player 12.

1. Turn on your PC and start Windows Media® Player 12.
2. Open the "Stream" menu and check that "Allow remote control of my Player..." is checked. Click "Turn on media streaming" to list players in the network.
3. Select and right-click the music file to play with Windows

E N



Media® Player 12. To remotely play a music file on another server, open the target server from "Other Libraries" and select the music file to play.

4. Select this unit in "Play to" to open the "Play to" window of Windows Media® Player 12 and start playback on the unit. If your PC is running on Windows® 8.1, click "Play to", and then select this unit. If your PC is running on Windows® 10, click "Cast to Device", and select this unit. Operations during remote playback are possible from the "Play to" window on the PC.
- Remote playback is not possible when using a network service or playing music files on a USB storage device.
 - Depending of the version of Windows, there may be differences in the names of items you can select.

Supported Audio Formats

For server playback and playback from a USB storage device, this unit supports the following music file formats.

- Note that playback via wireless LAN of sampling rates of 88.2 kHz or higher, and DSD are not supported.
- Remote play of FLAC, and DSD is also not supported.
- Variable bit-rate (VBR) files are supported. However, playback times may not be displayed correctly.
- Remote playback does not support the gapless playback.

MP3 (.mp3/.MP3):

- Supported formats: MPEG-1/MPEG-2 Audio Layer-3
- Supported sampling rates: 44.1 kHz, 48 kHz
- Supported bitrates: Between 8 kbps and 320 kbps and VBR.

WMA (.wma/.WMA):

- Supported sampling rates: 44.1 kHz, 48 kHz
- Supported bitrates: Between 8 kbps and 320 kbps and VBR.
- WMA Pro/Voice/WMA Lossless formats are not supported

WAV (.wav/.WAV):

WAV files include uncompressed PCM digital audio.

- Supported sampling rates: 44.1 kHz, 48 kHz, 88.2 kHz, 96 kHz, 176.4 kHz, 192 kHz
- Quantization bit: 8 bit, 16 bit, 24 bit

AIFF (.aiff/.aif/.aifc/.afc/.AIFF/.AIF/.AIFC/.AFC):

AIFF files include uncompressed PCM digital audio.

- Supported sampling rates: 44.1 kHz, 48 kHz, 88.2 kHz, 96 kHz, 176.4 kHz, 192 kHz
- Quantization bit: 8 bit, 16 bit, 24 bit

AAC (.aac/.m4a/.mp4/.3gp/.3g2/.AAC/.M4A/.MP4/.3GP/.3G2):

- Supported formats: MPEG-2/MPEG-4 Audio
- Supported sampling rates: 44.1 kHz, 48 kHz, 88.2 kHz, 96 kHz
- Supported bitrates: Between 8 kbps and 320 kbps and VBR.

FLAC (.flac/.FLAC):

- Supported sampling rates: 44.1 kHz, 48 kHz, 88.2 kHz, 96 kHz, 176.4 kHz, 192 kHz
- Quantization bit: 8 bit, 16 bit, 24 bit

LPCM (Linear PCM):

- Supported sampling rates: 44.1 kHz, 48 kHz
- Quantization bit: 16 bit

Apple Lossless (.m4a/.mp4/.M4A/.MP4):

- Supported sampling rates: 44.1 kHz, 48 kHz, 88.2 kHz, 96 kHz, 176.4 kHz, 192 kHz
- Quantization bit: 16 bit, 24 bit

DSD (.dsf/.dff/.DSF/.DFF):

- Supported formats: DSF/DSDIFF
- Supported sampling rates: 2.8 MHz, 5.6 MHz, 11.2 MHz



Entering text

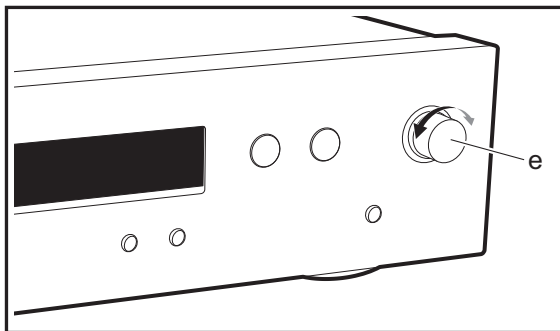
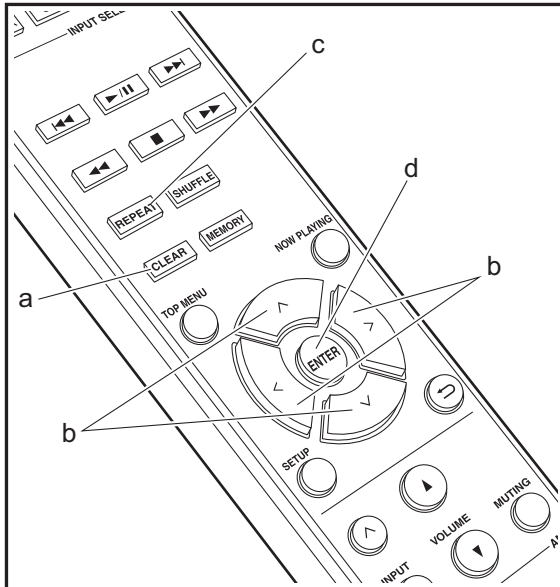

Text entry, for passwords, etc., uses the following procedure.

1. Select the characters or symbols with ^/~/</> (b).



2. Press ENTER (d) to confirm the selected character.

Repeat this to enter text.

- Press REPEAT (c) to change the characters to be enter, for example to switch between upper and lower case.
- Press CLEAR (a) to delete all the input characters.

3. After completing input, select "OK" with ^/~/</> (b) and press ENTER (d).

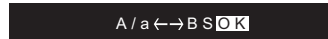

- Turn MENU/ENTER (e) on the main unit to the left and right to select the item, then press the dial to confirm.

Characters that can be entered

a

a	b	c	d	e	f	g	h	i	j	k	l	m
n	o	p	q	r	s	t	u	v	w	x	y	z
1	2	3	4	5	6	7	8	9	0	-	^	\
,	.	/	;	:	@	[]	S	p	a	c	e
A/a		<->		B		S		O		K		

A

A	B	C	D	E	F	G	H	I	J	K	L	M
N	O	P	Q	R	S	T	U	V	W	X	Y	Z
!	"	#	\$	%	&	'	()	_	=	~	
<	>	?	+	*	^	{	}	S	p	a	c	e
A/a		<->		B		S		O		K		

Space: A single space the size of a character is entered.

A/a: Switches between characters displayed. (a → A)

<- (left) / -> (right) : Select to move the cursor.

BS (backspace): Removes a character on the left of the cursor. The cursor moves left.

OK: Confirms the entered content.

E
N



Supplementary information for player functions

Due to firmware (the software for the system) updates after you make your purchase or firmware changes during production of the product, there may be additions or changes to the features available compared to what is in the instruction manual.

For information about player functions that have been added or changed, see the following references.

[Supplementary information for player functions](#)

>>> [Click here](#) <<<





Advanced Settings

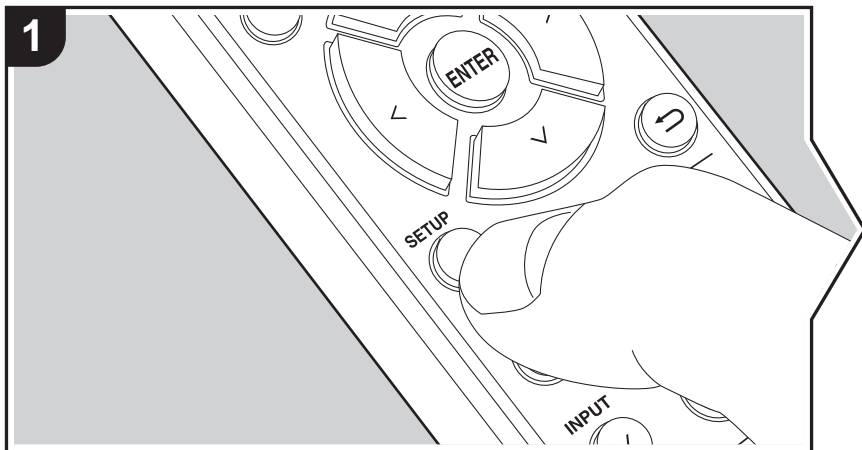

The unit allows you to configure advanced settings to provide you with an even better experience.

1. Press SETUP on the remote controller.
2. Select the item with \wedge/\vee on the remote controller and press ENTER to confirm.

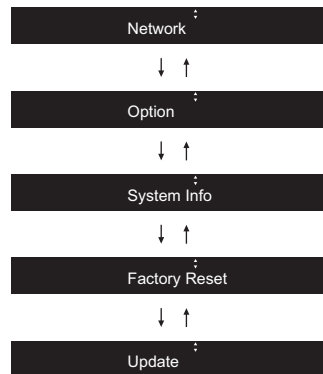

3. Select the settings with $\wedge/\vee/\langle/\rangle$ on the remote controller and press ENTER to confirm.

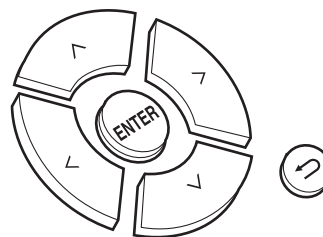

- To return to the previous screen, press \leftarrow .
4. To exit the settings, press SETUP.



Network

■ Connection

Select the type connection to the network.

Select the item with </> on the remote controller and press ENTER.

"Wi-Fi": To connect via wireless LAN

"Wired" (Default Value): To connect via wired LAN

Perform "Wi-Fi Setup" if you select "Wi-Fi".

■ Wi-Fi Setup

Make Wi-Fi connection settings. (→P10)

This can be set only when "Wi-Fi" is selected in "Connection".

- You can make Wi-Fi connection settings using a web browser on a computer. For details, refer to "Web Setup" (→P27).

■ DHCP

Select the item with </> on the remote controller and press ENTER .

"On" (Default Value): Auto configuration by DHCP

"Off": Manual configuration without DHCP

If selecting "Off", you must set "IP Address", "Subnet Mask", "Gateway", and "DNS" manually.

■ IP Address

Displays/Sets the IP address.

■ Subnet Mask

Displays/Sets the subnet mask.

■ Gateway

Displays/Sets the gateway.

■ DNS

Displays/Sets the primary DNS server.

■ Proxy URL

Displays/Sets the proxy server URL.

■ Proxy Port

Displays/Sets the proxy server port number when you enter "Proxy URL".

■ Friendly Name

Change the device name for this unit which is shown on other devices connected to the network to an easily recognized name. You can input up to 31 characters. For details on how to enter text, refer to "Entering text" (→P22).

■ AirPlay PW

You can set a password of up to 31 characters so that only registered users can use AirPlay. For details on how to enter text, refer to "Entering text" (→P22).

■ Network Check

You can check the network connection. The confirmation results are displayed when you press ENTER.

Option

■ PWR Setting

Auto Standby	This setting places the unit on standby automatically after 20 minutes of inactivity without any audio input. "On" (Default Value): The unit will automatically enter standby mode. "Off ": The unit will not automatically enter standby mode.
NET Stby	When this feature is turned "On", you can turn on the power of the unit via the network using an application that can control this unit. Select the item with </> on the remote controller and press ENTER. • Setting to "On" (Default Value) increases the power consumption even when the unit is on standby. • "NET Stby", which suppresses power consumption, may be disabled when the network connection is lost.



■ Dig Filter

Select the item with </> on the remote controller and press ENTER.

"SHARP" (Default Value): Sound with more structure and firmness

"SHORT": Sound that starts quick and seems to move forward

"SLOW": Soft and fluid sound

■ Digital Out

Make settings for digital audio output.

Select the item with </> on the remote controller and press ENTER.

"On" (Default Value), "Off"

■ Tuner Setting

Search Level	You can choose to have only those FM stations with strong reception selected when tuning into stations automatically if tuning regularly stops on FM stations with weak reception. Select the item with </> on the remote controller and press ENTER. "Normal" (Default Value) "Strong" : Select only stations with strong reception.
DAB Scan	You can run the auto scan when new DAB stations are added or when you move house.
DAB DRC	With the DRC (Dynamic Range Control) setting, you can reduce the dynamic range of DAB digital radio so that you can still hear quiet parts even when listening at low volume levels - ideal for listening to the radio late at night when you don't want to disturb anyone. Select the item with </> on the remote controller and press ENTER. "0" (Default Value) : DRC off "1" : Large reduction in dynamic range "1/2" : Small reduction in dynamic range
NameEdit (FM stations only)	You can give names to the stations that you have registered. For details on how to enter text, refer to "Entering text" (➔P22).

System Info

The MAC address of this unit and the current firmware version will be displayed.

Select "MAC address" or "Firmware" with ^/∨ on the remote controller.

Factory Reset

Reset the settings of this unit to the status at the time of shipment. We recommend that you take a note of the settings you have changed before going ahead with a factory reset.

To reset, select "Reset Start" with ^/∨ on the remote controller and press ENTER. Press ENTER again to start the rest. The unit will be placed on standby automatically when initializing is completed.

Update

"Update" is not displayed if there are no firmware updates.

■ via Network

Press ENTER to select when you want to update the firmware via network.

■ via USB

Press ENTER to select when you want to update the firmware via USB.

EN



Web Setup

You can make Wi-Fi connection settings using a web browser on a computer. Be sure your computer is connected to the router wirelessly.

If this unit is connected to the router using ethernet cable, you can not do this setting.

1. Turn the unit on.
2. Press SETUP on the remote controller, select "Wi-Fi" in "Network" - "Connection", then select "Wi-Fi Setup".
3. Press \wedge/\vee to select "iOS device" and press ENTER.
4. In the list of wireless LAN connections on your computer, select SSID of this unit (softap_0009B0xxxxxx).
 - "xxxxxx" in SSID is the lower three bytes of the MAC address.
5. Open the web browser on your computer and access <http://192.168.200.1>.
6. The "Web Setup" menu is displayed. Make network settings for this unit.
 - Depending on the equipment being used or connection environment, this function may not work.
 - Consult the appropriate operating instructions for information regarding operation of the computer.
 - Since this kind of connection is not encoded, a minor security risk may be involved.



Firmware Update

The updating function on this unit

This unit has functionality to update the firmware (the system software) over a network or by the USB port. This enables us to make improvements to a variety of operations and to add features.

How to update

There are two methods for updating the firmware: via network and via USB. The update may take about 5 minutes to complete for either method: via network or via USB. Furthermore, existing settings are guaranteed regardless of the method used for update.

- For the latest information on updates, visit our company's website. There is no need to update the firmware on this unit if there is no update available.
- When performed over the network, it may take even more time depending on the connection status.
- During an update, do not
 - Disconnect and reconnect any cable or USB storage device, or perform any operation on the component such as turn off its power
 - Accessing this unit from a PC or smartphone using an application

Disclaimer: The program and accompanying online documentation are furnished to you for use at your own risk. We will not be liable and you will have no remedy for damages for any claim of any kind whatsoever concerning your use of the program or the accompanying online documentation, regardless of legal theory, and whether arising in tort or contract.

In no event will we be liable to you or any third party for any special, indirect, incidental, or consequential damages of any kind, including, but not limited to, compensation, reimbursement or damages on account of the loss of present or prospective profits, loss of data, or for any other reason whatsoever.

Updating the Firmware via Network

- Check that the unit is turned on, and the connection to the Internet is secured.
- Turn off the controller component (PC etc.) connected to the network.

- Stop any playing Internet radio, USB storage device, or server content.
1. "Network" is displayed on the display when SETUP on the remote controller is pressed.



2. Press \wedge/\vee and ENTER to select "Update" - "via Network" in order.



- "Update" is not displayed if there are no firmware updates.
3. Press ENTER to start the firmware update.
 - "Completed" is displayed when the update is complete.
 4. Press ON/STANDBY on the main unit to switch the unit to standby. The process is completed and your firmware is updated to the latest version.

If an error message is displayed: When an error occurs, "* - * * Error!" is displayed on the display of this unit. ("*" represents an alphanumeric character.) Check the following:

- * -01, * -10: Ethernet cable not found. Connect the Ethernet cable properly.
- * -02, * -03, * -04, * -05, * -06, * -11, * -13, * -14, * -16, * -17, * -18, * -20, * -21: Internet connection error. Check the following:
 - The router is turned on
 - This unit and the router are connected via the network. Try to disconnect and then connect again the power to the unit and router. This may solve the problem. If you are still unable to connect to the Internet, the DNS server or proxy server may be temporarily down. Check the service status with your ISP provider.
- **Others:** Disconnect then reconnect the AC power cord, then repeat from the beginning.



Updating via USB

- Prepare a 128 MB or larger USB storage device. FAT16 or FAT32 file system format.
- Delete any data stored on the USB storage device.
- Turn off the controller component (PC etc.) connected to the network.
- Stop any playing Internet radio, USB storage device, or server content.
- Some USB storage devices may take long to load, may not be loaded correctly, or may not be correctly fed depending on the device or their content.
- We will not be liable whatsoever for any loss or damage of data, or storage failure arising from the use of the USB storage device with this unit. Thank you for your understanding.

1. Connect the USB storage device to your PC.
2. Download the firmware file from our company's website to your PC and unzip.

Firmware files are named in the following way:

ONKNAP ****_*****_***.zip
Unzip the file on your PC. The number of unzipped files and folders varies depending on the model.

3. Copy all unzipped files and folders to the root folder of the USB storage device.
 - Make sure to copy the unzipped files.
4. Connect the USB storage device to the USB port of this unit.
 - If you connect a USB hard disk drive to the USB port of the unit, we recommend that you use its AC adapter to power it.
 - If the USB storage device has been partitioned, each section will be treated as an independent device.
5. "Network" is displayed on the display when SETUP on the remote controller is pressed.



6. Press ^/v and ENTER to select "Update" - "via USB" in

order.



- "Update" is not displayed if there are no firmware updates.
7. Press ENTER to start the firmware update.
 - "Completed" is displayed when the update is complete.
 8. Press ON/STANDBY on the main unit to switch the unit to standby. The process is completed and your firmware is updated to the latest version.
 9. Remove the USB storage device from this unit.

If an error message is displayed: When an error occurs, " * - * * Error!" is displayed on the display of this unit.

Check the following:

- * -01, * -10: USB storage device not found. Check whether the USB storage device or USB cable is correctly inserted to the USB port of this unit. Connect the USB storage device to an external power source if it has its own power supply.
- * -05, * -13, * -20, * -21: The firmware file is not present in the root folder of the USB storage device, or the firmware file is for another model. Retry from the download of the firmware file.
- **Others:** Disconnect then reconnect the AC power cord, then repeat from the beginning.



Troubleshooting

Before starting the procedure

When operation is unstable, problems may be solved by simply turning the power on or to standby or disconnecting/connecting the power cord, rather than reviewing settings and operations. Try the simple measures on both the unit and the connected device. If the problem isn't fixed after referring to "Troubleshooting", resetting the unit to the status at the time of shipment may solve the problem. Note that your settings will also be initialized when you reset, so we recommend that you note down your settings before doing the following.

Resetting the unit (this resets the unit settings to the default)

1. Press SETUP on the remote controller, select "Factory Reset" - "Reset Start" in the Setup screen and press ENTER.
2. Press ENTER.
3. The unit switches to standby and the settings are reset.

■Power

Cannot turn on the unit

- Unplug the power cord from the wall outlet, wait 5 seconds or more, then plug it in again.

The unit turns off unexpectedly

- The unit automatically switches to standby when the "Option" - "PWR Setting" - "Auto Standby" setting in the Setup menu functions.

■The display doesn't light

- The display may go dim while the DIMMER is working, and may also turn off. Press DIMMER button and change the brightness level of the display.

■Wi-Fi Connection

- Try plugging/unplugging the power supply of wireless LAN router and the unit, check the wireless LAN router power-on status, and try reboot of the wireless LAN router.

Cannot connect to the access point

- Check that the setting of SSID and encryption (WEP, etc.) is correct. Make sure the network settings of the unit is properly set.
- Connection to an SSID that includes multi-byte characters is not supported. Name the SSID of the wireless LAN router using single-byte alphanumeric characters only and try again.
- When the wireless LAN router setting is at stealth mode (mode to hide the SSID key) or when ANY connection is off, the SSID is not displayed. Change the setting and try again.

Connected to an SSID different to the SSID selected

- Some access points allow you to set multiple SSIDs for one unit. If you use the automatic setting button on such a router, you may end up connecting with a different SSID from the SSID you wanted to connect to. Use the connection method requiring you to enter a password if this happens.

Playback is interrupted and communication does not work

- Shorten the distance from the access point or remove obstacles to improve visibility, and try again. Place the unit away from microwave ovens or other access points. It is recommended to place the access point and the unit in the same room.
- If there is a metallic object near the unit, wireless LAN connection may not be possible as the metal can effect on the radio wave.
- When other access point are used near the unit, several issues such as interrupted playback and communication

may occur. You can avoid these issues by changing the channel of the access point. For instructions on changing channels, see the instruction manual provided with the access point.

■Cannot Play USB storage device / HDD

- Check whether the USB storage device or USB cable is correctly inserted to the USB port of the unit.
- Disconnect the USB storage device from the unit, and then try reconnecting.
- This unit may not recognize USB storage devices and HDDs as proper devices sometimes. Try switching this unit to standby and then turning it on again.
- Depending on the type of format, the playback may not be performed normally. Check the type of the file formats that is supported. (➔P13)
- Cautions regarding USB and HDD devices (➔P13)

■FM reception is poor

- Re-check the antenna connection.
- Separate the antenna from the power cord.
- Move the unit away from your TV or PC.
- Passing cars and airplanes can cause interference.
- Concrete walls weaken radio signals.
- FM reception may become clearer if you use the antenna jack on the wall used for the TV.
- FM reception improves if the tuning mode is set to manual (➔P16). However, reception will be monaural rather than stereo.

■Network function

- If you cannot select a network service, it will become selectable when the network function is started.
- Try plugging/unplugging the power supply of this unit and the router, and try rebooting the router.



Cannot access the Internet radio

- Certain network service or contents available through the unit may not be accessible in case the service provider terminates its service.
- Make sure that your modem and router are properly connected, and make sure they are both turned on.
- Depending on ISP, setting the proxy server is necessary.
- Make sure that the used router and/or modem is supported by your ISP.

Cannot access the network server

- This unit needs to be connected to the same router as the network server.
- This unit is compatible with Windows Media® Player 11 or 12 network servers or NAS that are compatible with home network functionality. Furthermore, when using a PC, only music files registered in the Windows Media Player library can be played.

Playback stops while listening to music files on the network server

- When the PC is serving as the network server, try quitting any application software other than the server software (Windows Media® Player 12, etc.).
- If the PC is downloading or copying large files, the playback may be interrupted.

The album names and artist names for the Music Server are not displayed

- Meta data, such as album names and artist names, needs to be recognized on the server for distribution to this unit, so this depends on the specifications of the NAS or server you are using.
- The file formats supported depend on the NAS or server software. For details, contact the manufacturer of NAS or the server software.



General Specifications

■ Audio Section

Rated RCA Output Level and Impedance

- 2 Vrms (RCA OUT 1 kHz, 0 dBfs)/470 Ω

Frequency response

- 4Hz - 70kHz (-3 dB)

THD+N

- 0.002 % (1 kHz 0 dBfs/RCA OUT/30 kHz LPF)

Dynamic range

- 114 dB (24 bit)

Channel separation

- 100 dB (1 kHz/RCA OUT/30 kHz LPF)

Signal to Noise Ratio

- 115 dB (A-weighting/RCA OUT)

■ Tuner Section

Tuning Frequency Range (FM)

- 87.5 MHz - 108.0 MHz, RDS

Preset Channel

- 40

Digital Tuner

- DAB+

■ Network Section

ETHERNET LAN

- 10BASE-T/100BASE-TX

Wireless LAN

- IEEE 802.11 a/b/g/n standard
- 5 GHz/2.4 GHz band

■ Output jacks

Analog audio output

- 2 (L/R)

Digital audio output

- 2 (OPTICAL, COAXIAL)

■ Other jacks

USB

- Front: 1
version: USB2.0
Maximum supplied current: 0.5 A
- Rear: 1
version: USB2.0
Maximum supplied current: 1.0 A

RI: 2

■ General

Power Supply

- AC 220 - 240 V, 50/60 Hz

Power Consumption

- 37 W
- 0.2 W (In Standby)
- 2.5 W (In Standby, NET Stby : On)

Dimensions (W × H × D)

- 435 mm × 100 mm × 317 mm

Weight

- 4.5 kg



License and Trademark Information



The Wi-Fi CERTIFIED Logo is a certification mark of Wi-Fi Alliance®.



AirPlay, iPad, iPhone, and iPod touch are trademarks of Apple Inc., registered in the U.S. and other countries.

iPad Air and iPad mini are trademarks of Apple Inc.

"Made for iPod", "Made for iPhone" and "Made for iPad" mean that an electronic accessory has been designed to connect specifically to iPod, iPhone, or iPad, respectively, and has been certified by the developer to meet Apple performance standards. Apple is not responsible for the operation of this device or its compliance with safety and regulatory standards.

Please note that the use of this accessory with iPod, iPhone or iPad may affect wireless performance.

AirPlay works with iPhone, iPad, and iPod touch with iOS 4.3.3 or later, Mac with OS X Mountain Lion or later, and PC with iTunes 10.2.2 or later.



The product with this logo is conformed to Hi-Res Audio standard defined by Japan Audio Society. This logo is used under license from Japan Audio Society.

This product is protected by certain intellectual property rights of Microsoft. Use or distribution of such technology outside of this product is prohibited without a license from Microsoft.

Windows and the Windows logo are trademarks of the Microsoft group of companies.

DSD and the Direct Stream Digital logo are trademarks of Sony Corporation.

MPEG Layer-3 audio coding technology licensed from Fraunhofer IIS and Thomson.

"All other trademarks are the property of their respective owners."

"Toutes les autres marques commerciales sont la propriété de leurs détenteurs respectifs."

"El resto de marcas comerciales son propiedad de sus respectivos propietarios."

"Tutti gli altri marchi di fabbrica sono di proprietà dei rispettivi proprietari."

"Alle anderen Warenzeichen sind das Eigentum ihrer jeweiligen Eigentümer."

"Alle andere handelsmerken zijn eigendom van de desbetreffende rechthebbenden."

"Alla andra varumärken tillhör deras respektive ägare".

ONKYO

1-10-5 Yokoami, Sumida-ku, Tokyo 130-0015 JAPAN

<http://www.onkyo.com/>

<U.S.A.>

18 Park Way, Upper Saddle River, N.J. 07458, U.S.A.

For Dealer, Service, Order and all other Business Inquiries:

Tel: 201-785-2600 Fax: 201-785-2650

<http://www.us.onkyo.com/>

For Product Support Team Only:

1-800-229-1687

<http://www.us.onkyo.com/>

<Germany>

Gutenbergstrasse 3, 82178 Puchheim, Germany

Tel: +49-8142-4401-0 Fax: +49-8142-4208-213

<http://www.eu.onkyo.com/>

<UK>

Anteros Building, Odyssey Business Park, West End Road, South Ruislip, Middlesex,
HA4 6QQ United Kingdom

Tel: +44 (0)871-200-1996 Fax: +44 (0)871-200-1995

<Hong Kong>

Unit 1033, 10/F, Star House, No 3, Salisbury Road, Tsim Sha Tsui Kowloon, Hong Kong.

Tel: +852-2429-3118 Fax: +852-2428-9039

<http://www.hk.onkyo.com/>

<PRC>

302, Building 1, 20 North Chaling Rd., Xuhui District, Shanghai, China 200032,

Tel: +86-21-52131366 Fax: +86-21-52130396

<http://www.cn.onkyo.com/>

<Asia, Oceania, Middle East, Africa>

Please contact an Onkyo distributor referring to Onkyo SUPPORT site.

<http://www.intl.onkyo.com/support/>

The above-mentioned information is subject to change without prior notice.

Visit the Onkyo web site for the latest update.

SN 29402681C

(C) Copyright 2016 Onkyo & Pioneer Corporation Japan. All rights reserved.

Onkyo group has established its Privacy Policy, available at [<http://www.onkyo.com/privacy/>].

E
N

F1711-3



* 2 9 4 0 2 6 8 1 C *