



PHONES

0 (800) 800 130
(050) 462 0 130
(063) 462 0 130
(067) 462 0 130

130
COM.UA

Internet store of
autogoods



SKYPE

km-130

CAR RECEIVERS — Receivers • Media receivers and stations • Native receivers • CD/DVD changers • FM-modulators/USB adapters • Flash memory • Facia plates and adapters • Antennas • Accessories |
 CAR AUDIO — Car audio speakers • Amplifiers • Subwoofers • Processors • Crossovers • Headphones • Accessories | TRIP COMPUTERS — Universal computers • Model computers • Accessories |
 GPS NAVIGATORS — Portable GPS • Built-in GPS • GPS modules • GPS trackers • Antennas for GPS navigators • Accessories | VIDEO — DVR • TV sets and monitors • Car TV tuners • Cameras • Videomodules
 • Transcoders • Car TV antennas • Accessories | SECURITY SYSTEMS — Car alarms • Bike alarms • Mechanical blockers • Immobilizers • Sensors • Accessories | OPTIC AND LIGHT — Xenon • Bixenon • Lamps
 • LED • Stroboscopes • Optic and Headlights • Washers • Light, rain sensors • Accessories | PARKTRONICS AND MIRRORS — Rear parktronic • Front parktronic • Combined parktronic • Rear-view mirrors
 • Accessories | HEATING AND COOLING — Seat heaters • Mirrors heaters • Screen-wipers heaters • Engine heaters • Auto-refrigerators • Air conditioning units • Accessories | TUNING — Vibro-isolation
 • Noise-isolation • Tint films • Accessories | ACCESSORIES — Radar-detectors • Handsfree, Bluetooth • Windowlifters • Compressors • Beeps, loudspeakers • Measuring instruments • Cleaners • Car seats
 • Miscellaneous | MOUNTING — Installation kits • Upholstery • Grilles • Tubes • Cable and wire • Tools • Miscellaneous | POWER — Batteries • Converters • Start-charging equipment • Capacitors
 • Accessories | MARINE AUDIO AND ELECTRONICS — Marine receivers • Marine audio speakers • Marine subwoofers • Marine amplifiers • Accessories | CAR CARE PRODUCTS — Additives • Washer fluid •
 Care accessories • Car polish • Flavors • Adhesives and sealants | LIQUID AND OIL — Motor oil • Transmission oil • Brake fluid • Antifreeze • Technical lubricant



In store "130" you can find and buy almost all necessary goods for your auto in Kyiv and other cities, delivery by ground and postal services. Our experienced consultants will provide you with exhaustive information and help you to choose the very particular thing. We are waiting for you at the address

<https://130.com.ua>



VIRTUSnano 602 / VIRTUSnano 603
VIRTUSnano 602 *Carbon* / VIRTUSnano 603 *Carbon* / VIRTUSnano INTEGRA 602 *Carbon*

2Way / 3Way / Integra Slim Component System Installation Guide

Autogoods "130"

VIRTUS PACKAGE CONTENT

6" WOOFER / INTEGRA



MT120N TWEETER (IN 2-WAY / 3-WAY ONLY)

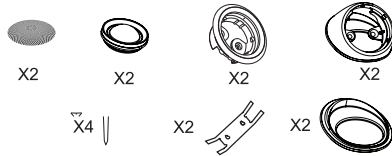

2-WAY / 3-WAY CROSSOVER

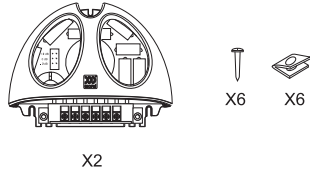

CDM600 MIDRANGE (IN 3-WAY ONLY)



WOOFER & CROSSOVER MOUNTING

6" UNIT MOUNTING

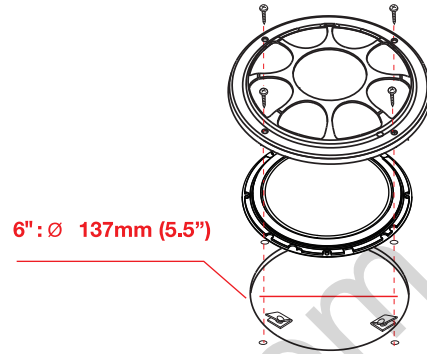

CROSSOVER MOUNTING

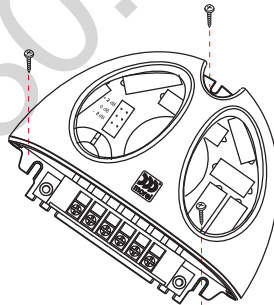

TWEETER MOUNTING

FLUSH MOUNTING

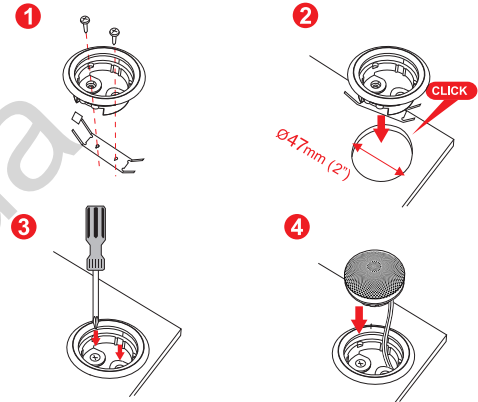

SURFACE MOUNTING

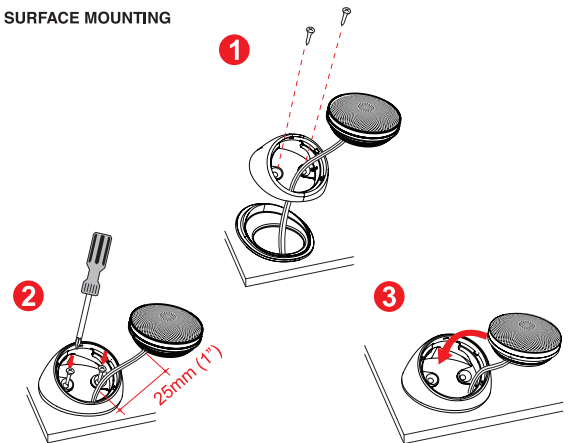

2-WAY CROSSOVER WIRING

PASSIVE SET UP

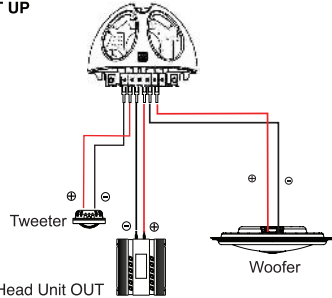

3-WAY CROSSOVER WIRING

PASSIVE SET UP

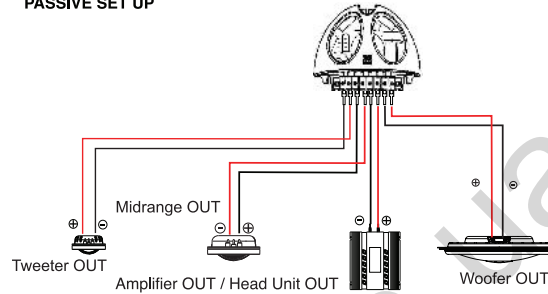

INTEGRA CROSSOVER WIRING

PASSIVE SET UP

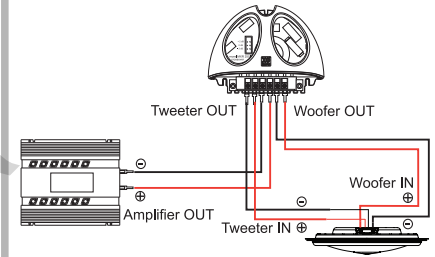

ACTIVE SET UP (Outputs must be filtered)

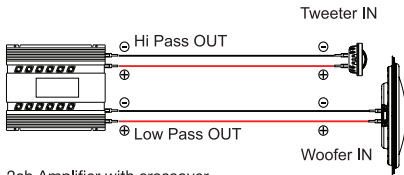

2ch Amplifier with crossover
filtered outputs at minimum 2,500 Hz

ACTIVE SET UP (Outputs must be filtered)

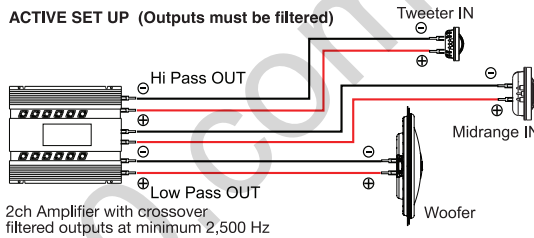

2ch Amplifier with crossover
filtered outputs at minimum 2,500 Hz

ACTIVE SET UP

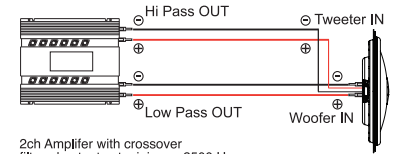

2ch Amplifier with crossover
filtered outputs at minimum 2500 Hz

TWEETER LEVEL ALIGNMENT

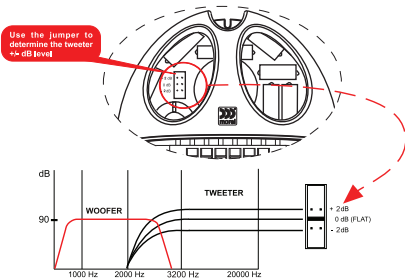

CDM600 MIDRANGE MOUNTING (IN 3-WAY ONLY)

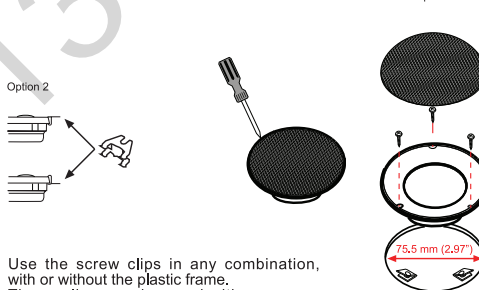

Use the screw clips in any combination,
with or without the plastic frame.
These clips can be used either way up
down depending on installation requirements.

TWEETER LEVEL ALIGNMENT

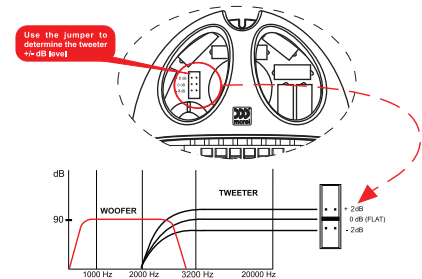

SPECIFICATIONS

WOOFERS	VIRTUS NANO MW6	VIRTUS NANO MW6C	INTEGRA WOOFER N
Nominal Impedance (Ohms)	4	4	4
Power Handling Wrms	80	100	100
Max. Trans.Pwr Handling Wrms	250	300	300
Sensitivity (2.83V/1M)	88dB	87dB	87dB
Frequency Response Hz	50-3500	50-5500	50-5500
Resonant Freq. Fs Hz	85	68	73
Voice Coil Diameter mm (inch)	54 (2.16)	54 (2.16)	54 (2.16)
Voice Coil Height mm (inch)	9.5 (0.4)	9.5 (0.4)	9.5 (0.4)
Voice Coil Type/ Former	Aluminum	Aluminum	Aluminum
Voice Coil Wire	Hexatech™ Aluminum	Hexatech™ Aluminum	Hexatech™ Aluminum
DC Resistance (Ohms)	4	3	3
Voice Coil Induct. @1 kHz (MH)	0.28	0.17	0.17
Magnet System	Neodymium Vented	Neodymium Vented	Neodymium Vented
HE-Magnetic Gap Height mm (inch)	4 (0.16)	4 (0.16)	4 (0.16)
BL Product/BXL	5.0	3.85	4.18
Max. Linear Ex./Xmax mm (inch)	±3 (0.12)	±3 (0.12)	±3 (0.12)
Electrical Q Factor QES	1.0	0.97	0.97
QTS	0.7	0.65	0.73
QMS	2.2	1.98	3.4
Moving Mass MMS - gr/ ounce	12.5	14	11.8
Equiv. Can Air Load VAS - L (cu.ft)	9	11	7.5
Effective Piston Area SD sq.cm (sq. inch)	141cm²	139cm²	116cm²
Cone Type	Treated Paper Cone	Carbon Cone	Carbon Cone
Cone Material	Carbon + Paper	Carbon + Foam core	Carbon + Foam core
Unit Diameter mm (inch)	6.5 (0.26)	6.5 (0.26)	6.5 (0.26)
Mounting Depth mm (inch)	17 (0.7)	17 (0.7)	17 (0.7)
Mounting Cutout mm (inch)	137 (5.48)	137 (5.48)	137 (5.48)
Net Weight gr.	450	450	450

INTEGRA TWEETER N	
Nominal Impedance (Ohm)	6
Power Handling (WRms)	130
Max Transient Power Handling W (10ms)	350
Sensitivity (2.83V/1M) dB	88
Frequency Response Hz	1600-25000
FS Hz	900
Voice Coil Diameter mm (inch)	28 (1.125)
Voice Coil Former	Aluminum
Voice Coil Wire	Hexatech™ Aluminium
DC Resistance Ohm	5.2
Magnet System	Neodymium
Dome Type	Accuflex™ Hand Coated Soft Dome
Dome Material	Silk

CROSSOVERS		MXR250i Carbon
Crossover Point		1800Hz/12dB/6dB
Crossover Controls		Tweeter+/- 2dB
Wiring Options		N/A

MIDS & TWEETERS	CDM600	MT120N	CDM600	MT120N
Nominal Impedance (ohm)	8	4	Hexatech™ Aluminum	Copper
Power Handling (Wrms)	100	80	DC Resistance ohm	3.5
Max Transient Power Handling W (10ms)	300	250	Magnet System	Neodymium Rear Vented
Sensitivity (2.83V/1M) dB	90	90	Dome Type	Selected soft dome
Frequency Response Hz	600-6000	1800-22000	Dome Material	Silk
FS Hz	480	1200	Unit Diameter mm (inch)	88.00 (3.50)
Voice Coil Diameter mm (inch)	54 (2.125)	28 (1.125)	Mounting Depth mm (inch)	21.00 (0.83)
Voice Coil Former	Aluminum	Aluminum	Mounting Cutout mm (inch)	75.50 (2.97)
			Net Weight Kg(lb)	0.25 (0.55)

CROSSOVERS	MXR200.3n	MXR300n
Crossover Point	2200Hz/12dB/6dB	W: 500Hz / 12dB M:18dB/ 2200Hz/ 12dB T: 2200Hz / 6dB
Crossover Controls	Tweeter+/- 2dB	Tweeter+/- 2dB
Wiring Options	N/A	N/A

* Morel operates a policy of continuous products design improvement, consequently specifications are subject to alteration without prior notice.



www.morelhifi.com