



PHONES

0 (800) 800 130
(050) 462 0 130
(063) 462 0 130
(067) 462 0 130

130
COM.UA

Internet store of
autogoods



SKYPE

km-130

CAR RECEIVERS — Receivers • Media receivers and stations • Native receivers • CD/DVD changers • FM-modulators/USB adapters • Flash memory • Facia plates and adapters • Antennas • Accessories |
CAR AUDIO — Car audio speakers • Amplifiers • Subwoofers • Processors • Crossovers • Headphones • Accessories | TRIP COMPUTERS — Universal computers • Model computers • Accessories |
GPS NAVIGATORS — Portable GPS • Built-in GPS • GPS modules • GPS trackers • Antennas for GPS navigators • Accessories | VIDEO — DVR • TV sets and monitors • Car TV tuners • Cameras • Videomodules
• Transcoders • Car TV antennas • Accessories | SECURITY SYSTEMS — Car alarms • Bike alarms • Mechanical blockers • Immobilizers • Sensors • Accessories | OPTIC AND LIGHT — Xenon • Bixenon • Lamps
• LED • Stroboscopes • Optic and Headlights • Washers • Light, rain sensors • Accessories | PARKTRONICS AND MIRRORS — Rear parktronic • Front parktronic • Combined parktronic • Rear-view mirrors
• Accessories | HEATING AND COOLING — Seat heaters • Mirrors heaters • Screen-wipers heaters • Engine heaters • Auto-refrigerators • Air conditioning units • Accessories | TUNING — Vibro-isolation
• Noise-isolation • Tint films • Accessories | ACCESSORIES — Radar-detectors • Handsfree, Bluetooth • Windowlifters • Compressors • Beeps, loudspeakers • Measuring instruments • Cleaners • Car seats
• Miscellaneous | MOUNTING — Installation kits • Upholstery • Grilles • Tubes • Cable and wire • Tools • Miscellaneous | POWER — Batteries • Converters • Start-charging equipment • Capacitors
• Accessories | MARINE AUDIO AND ELECTRONICS — Marine receivers • Marine audio speakers • Marine subwoofers • Marine amplifiers • Accessories | CAR CARE PRODUCTS — Additives • Washer fluid •
Care accessories • Car polish • Flavors • Adhesives and sealants | LIQUID AND OIL — Motor oil • Transmission oil • Brake fluid • Antifreeze • Technical lubricant



In store "130" you can find and buy almost all necessary goods for your auto in Kyiv and other cities, delivery by ground and postal services. Our experienced consultants will provide you with exhaustive information and help you to chose the very particular thing. We are waiting for you at the address

<https://130.com.ua>

MTX[®]

AUDIO

 mtxaudio.eu

 twitter.com/MTXEurope

 facebook.com/MTXEurope



TX815

6000W Peak, 2000W RMS 38cm (15") 2Ω Subwoofer
Designed by MTX in Phoenix, AZ - USA

Autogoods "130"

● TX815 Parameters :

(F) Paramètres, (E) Parameter, (D) Parameter, (I) Parametri, (P) Parâmetros, (NL) Parameters, (RUS) Параметры, (RO) Parametrii, (FIN) Parametrit, (PL) Parametry

- Fs : 35 Hz
- Re : 2 Ω
- Z : 2 Ω
- Qms : 5,46
- Qes : 0,56
- Qts : 0,51
- Vas : 44,7 liters
- Prms : 2000 Watts
- Mms : 406,6 grams
- Cms : 0,050 mm/N
- Bl : 19 N/A
- Sd : 793,4 cm²
- Vd : 0,992 liter
- Xmax : 12,5 mm
- SPL 2,83V/1m : 91,0 dB

● TX815 Dimensions :

(F) Dimensions, (E) Dimensiones, (D) Abmessungen, (I) Dimensioni, (P) Dimensões, (NL) Afmetingen, (RUS) Размеры, (RO) Dimensiuni, (FIN) Mitat, (PL) Wymiary

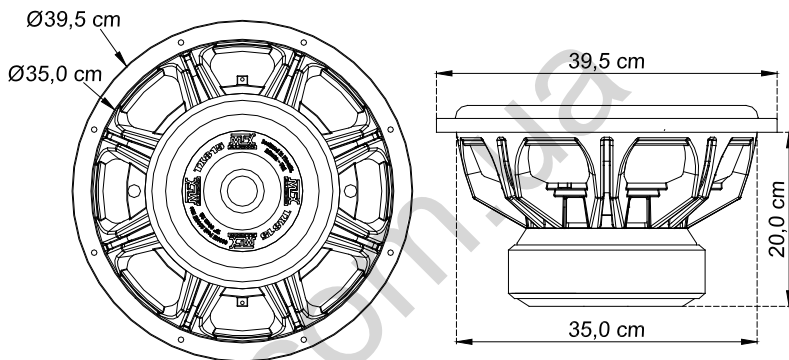

● TX815 Recommended amp : RT1000.1D

TX815 Recommended amp power : 1000-2000W RMS

(F) Puissance ampli recommandée, (E) La Potencia nominal recomendada, (D) Empfohlene Verstärkerleistung, (I) Potenza consigliata dell'amplificatore, (P) Potência de amplificação recomendada, (NL) Advies versterkervermogen, (RUS) Рекомендуемая мощность усилителя, (RO) Puterea recomandata a amplificatorului, (FIN) Suositeltava vahvistinteho, (PL) Rekomendowana moc wzmacniacza

● TX815 Wiring configurations :

(F) Exemples de câblage, (E) Configuración del cableado, (D) Verkabelung, (I) Configurazione di collegamento, (P) Configuração de cablagem, (NL) Aansluit mogelijkheden, (RUS) Схема подключения, (RO) Configuratia firelor, (FIN) Johdotuksen kokoonpano, (PL) Konfiguracja połączeń

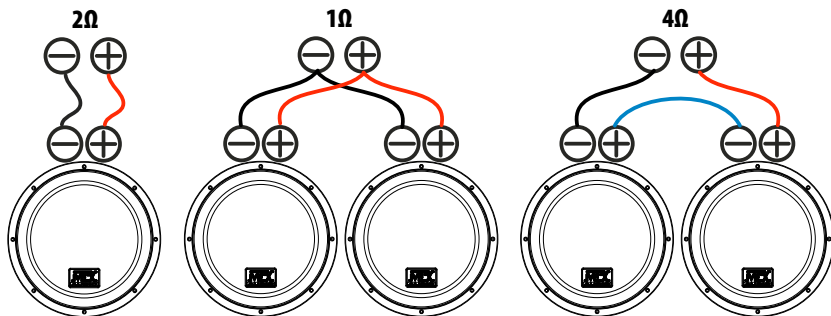

#1 Sealed Enclosure : SQ, to play clean and deep !

(F) Caisson clos pour qualité sonore et linéarité, (E) Cajón Sellado, (D) Geschlossenes Gehäuse, (I) Cassa a sospensione pneumatica, (P) Caixa fechada, (NL) Gesloten behuizing, (RUS) Закрытый корпус, (RO) Incinta in compresie, (FIN) Suljettu kotelo, (PL) Obudowa zamknięta

48 liters

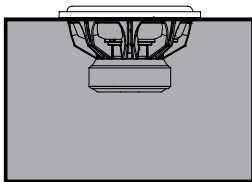

Specifications :

Total Volume : 48,0 liters
F-3 : 51Hz
F-10 : 37Hz
Qtc : 0,7
Damping material : 50%

#2 Vented enclosure : SQL, to play loud !

(F) Caisson bass-reflex pour jouer fort et tenir ses voisins éveillés, (E) Cajón Reflex, (D) Bassreflexgehäuse, (I) Cassa con accordo reflex, (P) Caixa reflex, (NL) Geoorpte behuizing, (RUS) Фазоинвертерный корпус, (RO) Incinta bas reflex, (FIN) Refleksi kotelo, (PL) Obudowa otwarta

75 liters

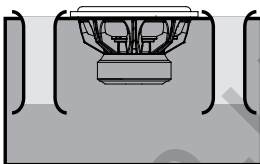

Specifications :

Total Volume : 75 liters
F-3 : 32Hz
F-10 : 25Hz
Fb : 39Hz
Ripple : 3dB
Vent diameter : 2x Aeroport Ø10cm
Vent length : 35cm
Damping material : 15%

#3 Vented enclosure : SPL, to win competitions !

(F) Caisson bass-reflex pour jouer fort et tenir ses voisins éveillés, (E) Cajón Reflex, (D) Bassreflexgehäuse, (I) Cassa con accordo reflex, (P) Caixa reflex, (NL) Geoorpte behuizing, (RUS) Фазоинвертерный корпус, (RO) Incinta bas reflex, (FIN) Refleksi kotelo, (PL) Obudowa otwarta

82 liters

Designed for SPL competition

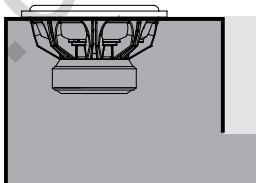

Specifications :

Total Volume : 82 liters
Fb : 55Hz
Ripple : 9dB
Slot port surface : 250cm²
Vent length : 25cm
Damping material : none

Frequency Response

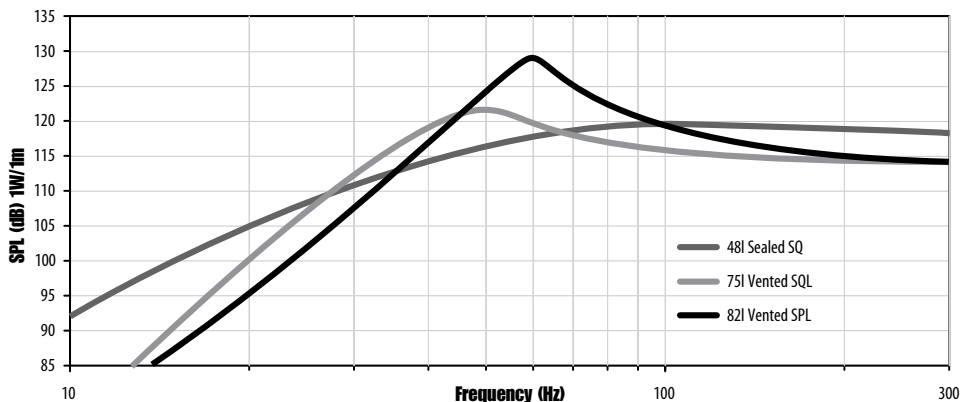

● #4 Dual Sealed Enclosure : SQ, to play clean and deep !

(F) Caisson clos pour qualité sonore et linéarité, (E) Cajón Sellado, (D) Geschlossenes Gehäuse, (I) Cassa a sospensione pneumatica, (P) Caixa fechada, (NL) Gesloten behuizing, (RUS) Закрытый корпус, (RO) Incinta in compresie, (FIN) Suljettu kotelo, (PL) Obudowa zamknięta

97 liters

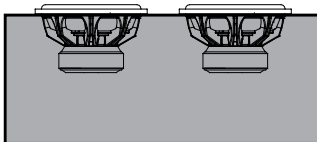

Specifications :

Total Volume : 97,0 liters
F-3 : 51Hz
F-10 : 28Hz
Qt_c : 0,70
Damping material : 50%

● #5 Dual Vented Enclosure : SQL, to play loud !

(F) Caisson bass-reflex pour jouer fort et tenir ses voisins éveillés, (E) Cajón Reflex, (D) Bassreflexgehäuse, (I) Cassa con accordo reflex, (P) Caixa reflex, (NL) Gevoorte behuizing, (RUS) Фазоинвертерный корпус, (RO) Incinta bas reflex, (FIN) Refleksi kotelo, (PL) Obudowa otwarta

137 liters

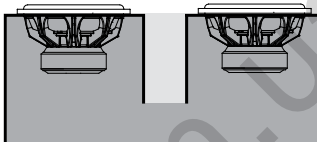

Specifications :

Total Volume : 137 liters
F-3 : 30Hz
F-10 : 23Hz
F_b : 35Hz
Ripple : 3dB
Vent area : 300cm²
Vent length : 34cm
Damping material : 15%

Frequency Response

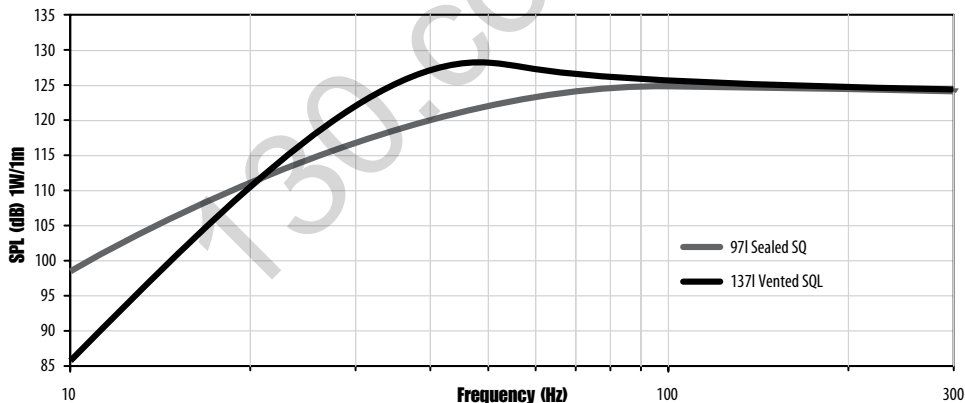

MTX is proud to be an
American Audio Company since 1971.

Designed and Engineered by MTX in Phoenix - AZ, USA.
© 2014 Mitek. All rights reserved. MTX is a registered trademark of Mitek.
Due to continual product development, all specifications are subject to change without notice.
Mitek - MTX 4545 East Baseline Rd. Phoenix, AZ 85042, USA

