



PHONES

0 (800) 800 130  
(050) 462 0 130  
(063) 462 0 130  
(067) 462 0 130

130  
COM.UA

Internet store of  
autogoods



SKYPE

km-130

CAR RECEIVERS — Receivers • Media receivers and stations • Native receivers • CD/DVD changers • FM-modulators/USB adapters • Flash memory • Facia plates and adapters • Antennas • Accessories |  
 CAR AUDIO — Car audio speakers • Amplifiers • Subwoofers • Processors • Crossovers • Headphones • Accessories | TRIP COMPUTERS — Universal computers • Model computers • Accessories |  
 GPS NAVIGATORS — Portable GPS • Built-in GPS • GPS modules • GPS trackers • Antennas for GPS navigators • Accessories | VIDEO — DVR • TV sets and monitors • Car TV tuners • Cameras • Videomodules  
 • Transcoders • Car TV antennas • Accessories | SECURITY SYSTEMS — Car alarms • Bike alarms • Mechanical blockers • Immobilizers • Sensors • Accessories | OPTIC AND LIGHT — Xenon • Bixenon • Lamps  
 • LED • Stroboscopes • Optic and Headlights • Washers • Light, rain sensors • Accessories | PARKTRONICS AND MIRRORS — Rear parktronic • Front parktronic • Combined parktronic • Rear-view mirrors  
 • Accessories | HEATING AND COOLING — Seat heaters • Mirrors heaters • Screen-wipers heaters • Engine heaters • Auto-refrigerators • Air conditioning units • Accessories | TUNING — Vibro-isolation  
 • Noise-isolation • Tint films • Accessories | ACCESSORIES — Radar-detectors • Handsfree, Bluetooth • Windowlifters • Compressors • Beeps, loudspeakers • Measuring instruments • Cleaners • Car seats  
 • Miscellaneous | MOUNTING — Installation kits • Upholstery • Grilles • Tubes • Cable and wire • Tools • Miscellaneous | POWER — Batteries • Converters • Start-charging equipment • Capacitors  
 • Accessories | MARINE AUDIO AND ELECTRONICS — Marine receivers • Marine audio speakers • Marine subwoofers • Marine amplifiers • Accessories | CAR CARE PRODUCTS — Additives • Washer fluid •  
 Care accessories • Car polish • Flavors • Adhesives and sealants | LIQUID AND OIL — Motor oil • Transmission oil • Brake fluid • Antifreeze • Technical lubricant



In store "130" you can find and buy almost all necessary goods for your auto in Kyiv and other cities, delivery by ground and postal services. Our experienced consultants will provide you with exhaustive information and help you to chose the very particular thing. We are waiting for you at the address

<https://130.com.ua>

# MTX<sup>®</sup>

## AUDIO

 [mtxaudio.eu](http://mtxaudio.eu)

 [twitter.com/MTXEurope](https://twitter.com/MTXEurope)

 [facebook.com/MTXEurope](https://facebook.com/MTXEurope)



# TX812

**5400W Peak, 1800W RMS 30cm (12") 2Ω Subwoofer**

**Designed by MTX in Phoenix, AZ - USA**

Autogoods "130"

## ● TX812 Parameters :

(F) Paramètres, (E) Parameter, (D) Parameter, (I) Parametri, (P) Parâmetros, (NL) Parameters, (RUS) Параметры, (RO) Parametrii, (FIN) Parametrit, (PL) Parametry

- Fs : 35 Hz
- Re : 2 Ω
- Z : 2 Ω
- Qms : 5,12
- Qes : 0,46
- Qts : 0,42
- Vas : 24,6 liters
- Prms : 1800 Watts
- Mms : 288,8 grams
- Cms : 0,070 mm/N
- Bl : 18 N/A
- Sd : 497,4 cm<sup>2</sup>
- Vd : 0,622 liter
- Xmax : 12,5 mm
- SPL 2,83V/1m : 90,0 dB

## ● TX812 Dimensions :

(F) Dimensions, (E) Dimensiones, (D) Abmessungen, (I) Dimensioni, (P) Dimensões, (NL) Afmetingen, (RUS) Размеры, (RO) Dimensiuni, (FIN) Mitat, (PL) Wymiary

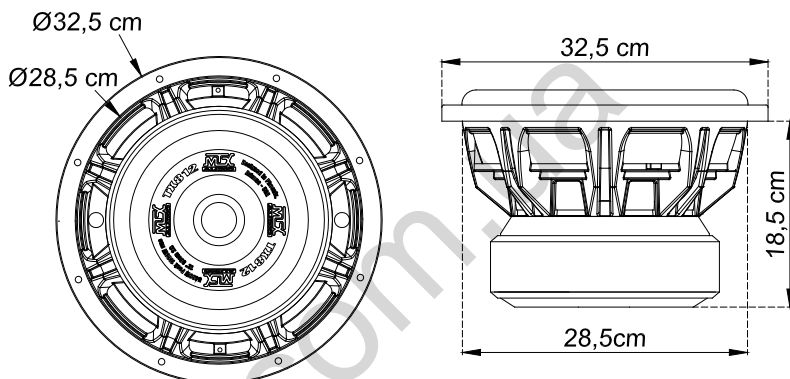

## ● TX812 Recommended amp : RT1000.1D

**TX812 Recommended amp power : 900-1800W RMS**

(F) Puissance ampli recommandée, (E) La Potencia nominal recomendada, (D) Empfohlene Verstärkerleistung, (I) Potenza consigliata dell'amplificatore, (P) Potência de amplificação recomendada, (NL) Advies versterkervermogen, (RUS) Рекомендуемая мощность усилителя, (RO) Puterea recomandata a amplificatorului, (FIN) Suositeltava vahvistinteho, (PL) Rekomendowana moc wzmacniacza

## ● TX812 Wiring configurations :

(F) Exemples de câblage, (E) Configuración del cableado, (D) Verkabelung, (I) Configurazione di collegamento, (P) Configuração de cablagem, (NL) Aansluit mogelijkheden, (RUS) Схема подключения, (RO) Configuratia firelor, (FIN) Johdotuksen kokoonpano, (PL) Konfiguracja połączeń

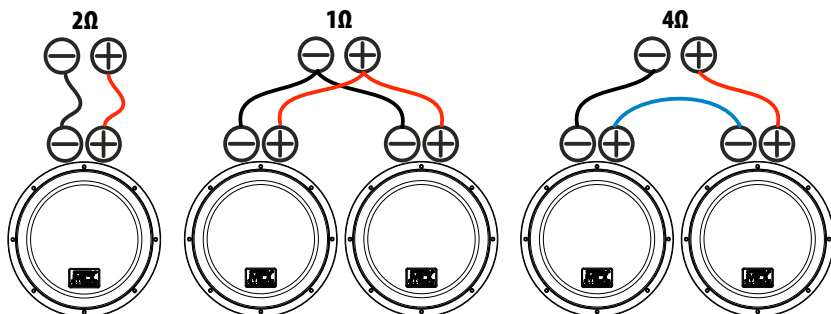

## ● #1 Sealed Enclosure : SQ, to play clean and deep !

(F) Caisson clos pour qualité sonore et linéarité, (E) Cajón Sellado, (D) Geschlossenes Gehäuse, (I) Cassa a sospensione pneumatica, (P) Caixa fechada, (NL) Gesloten behuizing, (RUS) Закрытый корпус, (RO) Incinta in compresie, (FIN) Suljettu kotelo, (PL) Obudowa zamknięta

# 30 liters

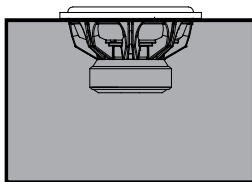

### Specifications :

Total Volume : 30,0 liters  
F-3 : 74Hz  
F-10 : 25Hz  
Qt<sub>c</sub> : 0,5  
Damping material : 50%

## ● #2 Vented enclosure : SQL, to play loud !

(F) Caisson bass-reflex pour jouer fort et tenir ses voisins éveillés, (E) Cajón Reflex, (D) Bassreflexgehäuse, (I) Cassa con accordo reflex, (P) Caixa reflex, (NL) Gevoorte behuizing, (RUS) Фазоинвертерный корпус, (RO) Incinta bas reflex, (FIN) Refleksi kotelo, (PL) Obudowa otwarta

# 54 liters

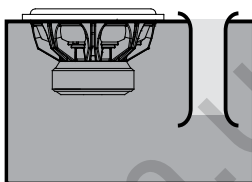

### Specifications :

Total Volume : 54 liters  
F-3 : 33Hz  
F-10 : 26Hz  
Fb : 40Hz  
Ripple : 3dB  
Vent diameter : 1x Aeroport 10cm  
Vent length : 25cm  
Damping material : 15%

## ● #3 Vented enclosure : SPL, to win competitions !

(F) Caisson bass-reflex pour jouer fort et tenir ses voisins éveillés, (E) Cajón Reflex, (D) Bassreflexgehäuse, (I) Cassa con accordo reflex, (P) Caixa reflex, (NL) Gevoorte behuizing, (RUS) Фазоинвертерный корпус, (RO) Incinta bas reflex, (FIN) Refleksi kotelo, (PL) Obudowa otwarta

# 67 liters

Designed for SPL competition

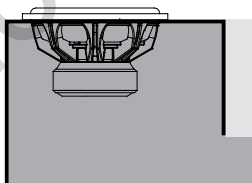

### Specifications :

Total Volume : 67 liters  
Fb : 55Hz  
Ripple : 9dB  
Slot port surface : 250cm<sup>2</sup>  
Vent length : 24cm  
Damping material : none

### Frequency Response

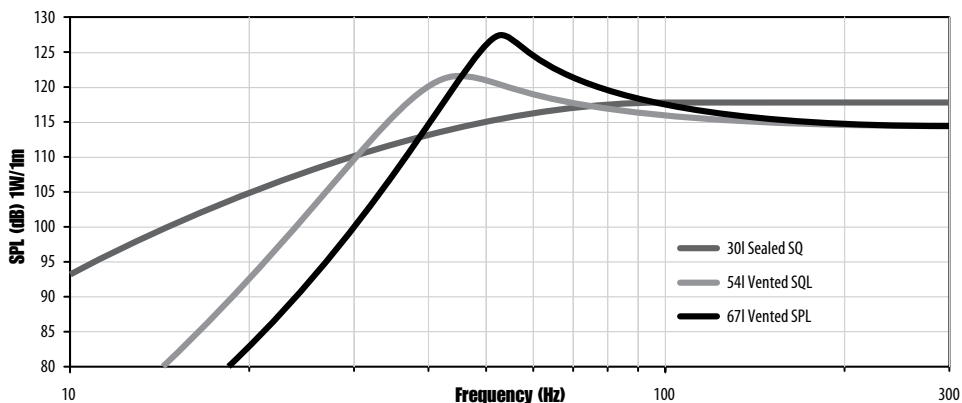

## ● #4 Dual Sealed Enclosure : SQ, to play clean and deep !

(F) Caisson clos pour qualité sonore et linéarité, (E) Cajón Sellado, (D) Geschlossenes Gehäuse, (I) Cassa a sospensione pneumatica, (P) Caixa fechada, (NL) Gesloten behuizing, (RUS) Закрытый корпус, (RO) Incinta in compresie, (FIN) Suljettu kotelo, (PL) Obudowa zamknięta

# 59 liters

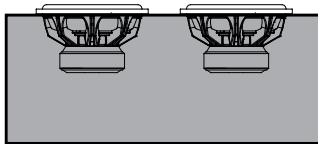

### Specifications :

Total Volume : 59,0 liters  
F-3 : 74Hz  
F-10 : 24Hz  
Qt<sub>c</sub> : 0,50  
Damping material : 50%

## ● #5 Dual Vented Enclosure : SQL, to play loud !

(F) Caisson bass-reflex pour jouer fort et tenir ses voisins éveillés, (E) Cajón Reflex, (D) Bassreflexgehäuse, (I) Cassa con accordo reflex, (P) Caixa reflex, (NL) Gevoorte behuizing, (RUS) Фазоинвертерный корпус, (RO) Incinta bas reflex, (FIN) Refleksi kotelo, (PL) Obudowa otwarta

# 112 liters

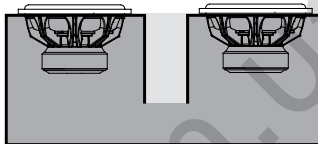

### Specifications :

Total Volume : 112 liters  
F-3 : 32Hz  
F-10 : 24Hz  
F<sub>b</sub> : 40Hz  
Ripple : 3dB  
Vent area : 250cm<sup>2</sup>  
Vent length : 30cm  
Damping material : 15%

### Frequency Response

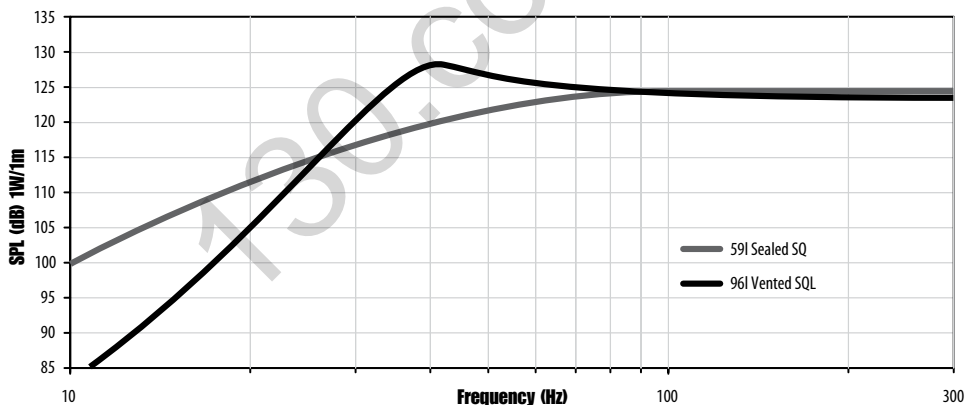

MTX is proud to be an  
American Audio Company since 1971.

Designed and Engineered by MTX in Phoenix - AZ, USA.  
© 2014 Mitek. All rights reserved. MTX is a registered trademark of Mitek.  
Due to continual product development, all specifications are subject to change without notice.  
Mitek - MTX 4545 East Baseline Rd. Phoenix, AZ 85042, USA

