

KENWOOD

DRV-A301W

GPS Integrated Dashboard Camera

INSTRUCTION MANUAL

JVCKENWOOD Corporation

- Updated information (the latest Instruction Manual, etc.) is available from <https://www.kenwood.com/cs/ce/>.

For your records

Record the serial number, found on the back of the unit in the spaces designated on the warranty card, and in the space provided below. Refer to the model and serial numbers whenever you can upon your KENWOOD dealer for information or service on the product.

Model DRV-A301W

Serial Number _____



US Residents Only

Register Online

Register your KENWOOD product at www.kenwood.com/usa

Contents

Before Use	01
Dashboard Camera Function Guide	01
Precautions for Use	02
Accessories	10
Key Features	10
Parts Name and Functions	11
Installation and Connection	14
Initial Settings	18
Basic Operation	20
Settings	30
Connection with Computer	32
Using the Desktop Software	33
Using the Smartphone App	43
Troubleshooting	51
Appendix	53
Specifications	56

Before Use

- The screen images and operation examples in this document were created for explaining the operating procedures.
- There may be screen images that differ from the actual screens or examples of operations not actually performed.

Disclaimer

- Please note that JVCKENWOOD shall not be responsible for any damages suffered by the customer or a third party as a result of incorrectly using this product, a failure during use of this product, or other trouble, or due to the use of this product, unless such liability is acknowledged by law.

Copyrights

- Recorded video, image, and audio content cannot be used for other than personal enjoyment without the consent of the copyright holder as specified in the Copyright Act.
- Please note that the recording of an event such as a show, performance, or exhibition may be restricted even when doing so for personal enjoyment.

Dashboard Camera Function Guide

With new technology readily available, JVCKENWOOD has developed an easy to use dashboard camera for everyday use. The device allows its user to record files in 1 / 3 / 5 minute lengths. These files are easy to download to your desktop or laptop.

In most instances, the video files are easily played on your mobile device.

While most cameras traditionally use the entire capacity of the SD card until it is removed, the device automatically deletes the oldest file to create space for the new video.

Dashboard camera offers three modes:

1. Video Mode: Video mode will set to default when the device is active.
2. Photo Mode: The device setting takes still photographs.
3. Playback Mode: Users can view all previously recorded videos and photos taken.

FEATURES:

Automatic Start/Stop Technology:

Maintain full focus on the road! The vehicles ignition will let the device turn on while connected to your vehicles 12 V outlet or cigarette lighter socket. When the vehicle is turned off, the device will automatically shut down, preserving the device power for those moments you are not connected to permanent power.

The device lets users adjust camera settings to get the perfect shot. For a great photo every time, here are a few tips from the designers:

1. Reduce the amount of sky in the picture. By adjusting the device towards the road, the automatic exposure compensation will be focused on the road and not the light from the sky.
2. Position the device in the center of the dash. If you place the device behind the rearview mirror, you will avoid all distractions from the road.
3. Remove any objects that will obstruct your shot such as the protective lens cover. Clear vision will allow you to record everything in one shot.

Precautions for Use

Precautions and notices

Warning! Do not operate the device while driving. Using this product does not change the requirement for a driver to take full responsibility for his or her behavior. This responsibility includes observing all traffic rules and regulations in order to avoid accidents, personal injury or property damage.

- For your own safety, do not operate the controls of the product while driving.
- A window mount is needed when using the device in a car. Make sure that you place the device in an appropriate place, so as not to obstruct the driver's view or deployment of airbags.
- Make sure that no object is blocking the camera lens and no reflective material is placed near the lens. Please keep the lens clean.
- If the car's windscreen is tinted with a coating, this may impact the recording quality.
- Connect the charger to a proper power source. The voltage requirements are found on the product case and/or packaging.
- Do not use the charger if the cord becomes damaged.
- Do not attempt to service the unit. There are no serviceable parts inside. Replace the unit if it is damaged or exposed to excess moisture.

Caring for your device

Taking good care of your device will ensure trouble-free operation and reduce the risk of damage.

- Keep your device away from excessive moisture and extreme temperatures.
- Avoid exposing your device to direct sunlight or strong ultraviolet light for extended periods of time.
- Do not place anything on top of your device or drop objects on your device.
- Do not drop your device or subject it to severe shock.
- Do not subject your device to sudden and severe temperature changes. This could cause moisture condensation inside the unit, which could damage your device. In the event of moisture condensation, allow the device to dry out completely before use.
- The screen surface can easily be scratched. Avoid touching it with sharp objects. Nonadhesive generic screen protectors designed specifically for use on portable devices with LCD panels may be used to help protect the screen from minor scratches.
- Never clean your device with the power on. Use a soft, lint-free cloth to wipe the screen and the exterior of your device.
- Do not use paper towels to clean the screen.
- Never attempt to disassemble, repair or make any modifications to your device. Disassembly, modification or any attempt at repair could cause damage to your device and even bodily injury or property damage and will void any warranty.
- Do not store or carry flammable liquids, gases or explosive materials in the same compartment as your device, its parts or accessories.
- To discourage theft, do not leave the device and accessories in plain view in an unattended vehicle.
- Overheating may damage the device.

Precautions for installation

- Install the device in a position where it will not block the front view of the driver (position where hidden by the rear-view mirror).
- Install the device so that it is within the wiping range of the wiper.
- Install the device in a position where it will not interfere with the movement of the rear-view mirror.
- Take care not to install the device over the vehicle inspection sticker or other sticker.
- Take care not to install the device where it will interfere with driving or airbag operation.
- When installing the device in a vehicle equipped with a driving support system, check the instruction manual of the vehicle and then select an installation position that will not interfere with the driving support system.
- If the device is installed incorrectly, event recording or parked recording may not work correctly.
- Refer to "Installation and Connection" for the loosening of fixing knob, installation orientation, installation angle, and other information and then install the device correctly.
- Do not install the device near a digital terrestrial television antenna or an electrical component.
- Doing so may reduce television receiver sensitivity or cause flickering and noise.
- When selecting a position for the suction mount, make sure it's on a glass surface that is smooth and free of paint.
- Before mounting, clean the area with a dry/clean cloth and add a small amount of moisture to the windshield. This allows a stronger bond to form between the glass and the suction mount.
- When fixing the device with the adhesive mount, use a commercially available cleaning cloth or the like to wipe off all dirt and grease on the mounting surface. If the device is re-affixed or mounted using, for example, general-purpose double-sided tape, the adhesion strength may weaken and cause the device to fall.
- After mounting the device, leave it for 24 hours before use to enable the mounting strength of the adhesive mount to improve. Failing to do so may result in the adhesion of the adhesive mount becoming weak and the device falling.
- Fix the cord in place with tape or the like so that it does not interfere with driving.

Precautions for use

- Do not block the camera lens, get dirt on it, or place a reflective object near it.
- When LED traffic lights are recorded, video in which they appear to be flickering or flashing may be recorded. JVCKENWOOD assumes no responsibility with regard to the distinguishing or recording of traffic lights.
If coating is used on the windshield of the vehicle, recording quality may be affected.
- There is no guarantee that the device can record video in all conditions.

Cleaning the device

- When the device is dirty, wipe it with a dry silicone cloth or other soft cloth. If the device is very dirty, remove the dirt with a cloth with neutral cleaner on it then wipe off the cleaner. Wiping the device with a hard cloth or using a volatile substance such as thinner or alcohol may cause scratches, deformation, deterioration or other damage.
- When the lens is dirty, gently wipe it with a soft cloth dampened with water. Rubbing the lens strongly with a dry cloth may cause scratches.

If you notice a problem with the device

If you notice a problem with the device, first refer to "Troubleshooting" (P. 51) and check whether there is a way to resolve the problem.

If the device does not return to normal after the reset, turn off the power of the device and then contact your dealer or nearest JVCKENWOOD service center.



Information on Disposal of Old Electrical and Electronic Equipment and Batteries (applicable for countries that have adopted separate waste collection systems)

Products and batteries with the symbol (crossed-out wheeled bin) cannot be disposed of as household waste.

Old electrical and electronic equipment and batteries should be recycled at a facility capable of handling these items and their waste by products.

Contact your local authority for details in locating a recycle facility nearest to you.

Proper recycling and waste disposal will help conserve resources while preventing detrimental effects on our health and the environment.



Declaration of Conformity with regard to the RE

Directive 2014/53/EU

Declaration of Conformity with regard to the RoHS

Directive 2011/65/EU

Manufacturer:

JVCKENWOOD Corporation
3-12, Moriyacho, Kanagawa-ku, Yokohama-shi,
Kanagawa 221-0022, JAPAN

EU Representative:

JVCKENWOOD Europe B.V.
Amsterdamseweg 37, 1422 AC UITHOORN, THE
NETHERLANDS

Déclaration de conformité se rapportant à la

directive RE 2014/53/UE

Déclaration de conformité se rapportant à la

directive RoHS 2011/65/UE

Fabricant:

JVCKENWOOD Corporation
3-12, Moriyacho, Kanagawa-ku, Yokohama-shi,
Kanagawa 221-0022, JAPON

Représentant dans l'UE:

JVCKENWOOD Europe B.V.
Amsterdamseweg 37, 1422 AC UITHOORN, PAYS-BAS

**Konformitätserklärung in Bezug auf die RE-
Richtlinie 2014/53/EU**

**Konformitätserklärung in Bezug auf die RoHS-
Richtlinie 2011/65/EU**

Hersteller:

JVCKENWOOD Corporation
3-12, Moriyacho, Kanagawa-ku, Yokohama-shi,
Kanagawa 221-0022, JAPAN

EU-Vertreter:

JVCKENWOOD Europe B.V.
Amsterdamseweg 37, 1422 AC UITHOORN,
NIEDERLANDE

Conformiteitsverklaring met betrekking tot RE-

richtlijn 2014/53/EU

Conformiteitsverklaring met betrekking tot RoHS-

richtlijn 2011/65/EU

Fabrikant:

JVCKENWOOD Corporation
3-12, Moriyacho, Kanagawa-ku, Yokohama-shi,
Kanagawa 221-0022, JAPAN

EU-vertegenwoordiger:

JVCKENWOOD Europa B.V.
Amsterdamseweg 37, 1422 AC UITHOORN, NEDERLAND

Dichiarazione di conformità relativa alla

direttiva RE 2014/53/UE

Dichiarazione di conformità relativa alla

direttiva RoHS 2011/65/UE

Produttore:

JVCKENWOOD Corporation
3-12, Moriyacho, Kanagawa-ku, Yokohama-shi,
Kanagawa 221-0022, JAPAN

Rappresentante UE:

JVCKENWOOD Europe B.V.
Amsterdamseweg 37, 1422 AC UITHOORN, PAESI BASSI

**Declaración de conformidad con respecto a la
Directiva RE 2014/53/UE**

**Declaración de conformidad con respecto a la
Directiva RoHS 2011/65/UE**

Fabricante:

JVCKENWOOD Corporation
3-12, Moriyacho, Kanagawa-ku, Yokohama-shi,
Kanagawa 221-0022, JAPAN

Representante en la UE:

JVCKENWOOD Europe B.V.
Amsterdamseweg 37, 1422 AC UITHOORN, PAÍSES
BAJOS

Declaração de Conformidade relativa à Diretiva RE 2014/53/UE

Declaração de conformidade relativa à Diretiva RoHS 2011/65/UE

Fabricante:

JVCKENWOOD Corporation
3-12, Moriyacho, Kanagawa-ku, Yokohama-shi,
Kanagawa 221-0022, JAPÃO

Representante na UE:

JVCKENWOOD Europe B.V.
Amsterdamsseweg 37, 1422 AC UITHOORN, PAÍSES
BAIXOS

RE Direktifi 2014/53/EU ile ilgili Uyum Beyanı

RoHS Direktifi 2011/65/EU için Uyum Beyanı

Üretici:

JVCKENWOOD Corporation
3-12, Moriyacho, Kanagawa-ku, Yokohama-shi,
Kanagawa 221-0022, JAPONYA

AB Temsilcisi:

JVCKENWOOD Europe B.V.
Amsterdamsseweg 37, 1422 AC UITHOORN, HOLLANDA

English

Hereby, JVCKENWOOD declares that the radio equipment DRV-A301W is in compliance with Directive 2014/53/EU. The full text of the EU declaration of conformity is available at the following internet address:

Français

Par la présente, JVCKENWOOD déclare que l'équipement radio DRV-A301W est conforme à la directive 2014/53/UE. L'intégralité de la déclaration de conformité UE est disponible à l'adresse Internet suivante:

Deutsch

Hiermit erklärt JVCKENWOOD, dass das Funkgerät DRV-A301W der Richtlinie 2014/53/EU entspricht. Der volle Text der EUKonformitätserklärung steht unter der folgenden Internetadresse zur Verfügung:

Nederlands

Hierbij verklaart JVCKENWOOD dat de radioapparatuur DRV-A301W in overeenstemming is met Richtlijn 2014/53/EU. De volledige tekst van de EU-verklaring van overeenstemming is te vinden op het volgende internetadres:

Italiano

Con la presente, JVCKENWOOD dichiara che l'apparecchio radio DRV-A301W è conforme alla Direttiva 2014/53/UE. Il testo integrale della dichiarazione di conformità UE è disponibile al seguente indirizzo internet:

Español

Por la presente, JVCKENWOOD declara que el equipo de radio DRV-A301W cumple la Directiva 2014/53/EU. El texto completo de la declaración de conformidad con la UE está disponible en la siguiente dirección de internet:

Português

Deste modo, a JVCKENWOOD declara que o equipamento de radio DRV-A301W está em conformidade com a Diretiva 2014/53/UE. O texto integral da declaração de conformidade da UE está disponível no seguinte endereço de internet:

Polska

Niniejszym, JVCKENWOOD deklaruje, że sprzęt radiowy DRV-A301W jest zgodny z dyrektywą 2014/53/UE. Pełny tekst deklaracji zgodności EU jest dostępny pod adresem: ije o usklađenosti dostupan je na sljedećoj internet adresi:

Český

Společnost JVCKENWOOD tímto prohlašuje, že rádiové zařízení DRV-A301W splňuje podmínky směrnice 2014/53/EU. Plný text EU prohlášení o shodě je dostupný na následující internetové adrese:

Magyar

JVCKENWOOD ezennel kijelenti, hogy a DRV-A301W rádióberendezés megfelel a 2014/53/EU irányelvnek. Az EU konformitási nyilatkozat teljes szövege az alábbi weboldalon érhető el:

Hrvatski

JVCKENWOOD ovim izjavljuje da je radio oprema DRV-A301W u skladu s Direktivom 2014/53/EU. Cjeloviti tekst deklaracije Europske un

Svenska

Härmed försäkras JVCKENWOOD att radioutrustningen DRV-A301W är i enlighet med direktiv 2014/53/EU. Den fullständiga texten av EUförsäkran om överensstämmelse finns på följande Internetadress :

Suomi

JVCKENWOOD julistaa täten, että radiolaitte DRV-A301W on direktiivin 2014/53/EU mukainen. EU-vaatimustenmukaisuusvakuutus löytyy kokonaisuudessaan seuraavasta internet-osoitteesta:

Slovensko

S tem JVCKENWOOD izjavlja, da je radijska oprema DRV-A301W v skladu z Direktivo 2014/53/EU. Celotno besedilo direktive EU o skladnosti je dostopno na tem spletnem naslovu:

Slovensky

Spoločnosť JVCKENWOOD týmto vyhlasuje, že rádiové zariadenie DRV-A301W vyhovuje smernici 2014/53/EÚ. Celý text EÚ vyhlásenia o zhode nájdete na nasledovnej internetovej adrese:

Dansk

Herved erklærer JVCKENWOOD, at radioudstyret DRV-A301W er i overensstemmelse med Direktiv 2014/53/EU. EUoverensstemmelseserklæringens fulde ordlyd er tilgængelig på følgende internetadresse:

Norsk

JVCKENWOOD erklærer herved at radioutstyret DRV-A301W er i samsvar med Direktiv 2014/53/EU. Den fullstendige teksten til EU-konformitetserklæringen er tilgjengelig på følgende internettadresse:

Ελληνικά

Με το παρόν, η JVCKENWOOD δηλώνει ότι ο ραδιοεξοπλισμός DRV-A301W συμμορφώνεται με την Οδηγία 2014/53/ΕΕ. Το πλήρες κείμενο της δήλωσης συμμόρφωσης της ΕΕ είναι διαθέσιμο στην ακόλουθη διεύθυνση στο διαδίκτυο:

Eesti

Käesolevaga JVCKENWOOD kinnitab, et DRV-A301W raadiovarustus on vastavuses direktiiviga 2014/53/EL. Eli vastavusdeklaratsiooni terviktekst on kättesaadav järgmisel internetiaadressil:

Latviešu

JVCKENWOOD ar šo deklarē, ka radio aparatūra DRV-A301W atbilst direktīvas 2014/53/ES prasībām. Pilns ES atbilstības deklarācijas teksts ir pieejams šādā tīmekļa adresē:

Lietuviškai

Šiuo JVCKENWOOD pažymi, kad radijo įranga DRV-A301W atitinka 2014/53/EB direktyvos reikalavimus. Visą EB direktyvos atitikties deklaracijos tekstą galite rasti šiuo internetiniu adresu:

Malti

B'dan, JVCKENWOOD jiddikjara li t-tagħmir tar-radju DRV-A301W huwa konformi mad-Direttiva 2014/53/UE. It-test kollu tad-dikjarazzjoni ta' konformità huwa disponibbli fl-indirizz intranet li ġej:

Українська

Таким чином, компанія JVCKENWOOD заявляє, що радіообладнання DRV-A301W відповідає Директиві 2014/53/EU. Повний текст декларації про відповідність ЄС можна знайти в Інтернеті за такою адресою:

Türkçe

Burada, JVCKENWOOD DRV-A301W radyo ekipmanının 2014/53/AB Direktifine uygun olduğunu bildirir. AB uyumluluk deklarasyonunun tam metni aşağıdaki internet adresinde mevcuttur.

Русский

JVCKENWOOD настоящим заявляет, что радиооборудование DRV-A301W соответствует Директиве 2014/53/EU. Полный текст декларации соответствия ЕС доступен по следующему адресу в сети Интернет:

Limba română

Prin prezenta, JVCKENWOOD declară că echipamentul radio DRV-A301W este în conformitate cu Directiva 2014/53/UE. Textul integral al declarației de conformitate UE este disponibil la următoarea adresă de internet:

Български език

С настоящото JVCKENWOOD декларира, че радиооборудването на DRV-A301W е в съответствие с Директива 2014/53/ЕС. Пълният текст на ЕС декларацията за съответствие е достъпен на следния интернет адрес:

URL: <https://www.kenwood.com/cs/ce/eudoc/>



Дата изготвяния (месец/год) на етикетката на уреда.

В съответствие с Законът на Русийската Федерация "О защите прав потребителей" срок службы (годности) данного товара, "по истечении которого он может представлять опасность для жизни, здоровья потребителя, причинять вред его имуществу или окружающей среде" составляет семь (7) лет со дня производства. Этот срок является временем, в течение которого потребитель данного товара может безопасно им пользоваться при условии соблюдения инструкции по эксплуатации данного товара, проводя необходимое обслуживание, включающее замену расходных материалов и/или соответствующее ремонтное обеспечение в специализированном сервисном центре.

Дополнительные косметические материалы к данному товару, поставляемые вместе с ним, могут храниться в течение двух (2) лет со дня его производства.

Срок службы (годности), кроме срока хранения дополнительных косметических материалов, упомянутых в предыдущих двух пунктах, не затрагивает никаких других прав потребителя, в частности, гарантийного свидетельства KENWOOD, которое он может получить в соответствии с законом о правах потребителя или других законов, связанных с ним.

Условия хранения:

Температура: от -20°C до +60°C

Влажность: от 5% до 95%

Информация о продукции

Производитель : ДжейВиСи Кенвуд Корпорейшн
3-12, Морийячо, Канагава-ку, Йокохама-ши, Канагава 221-0022, Япония

Видеорегистратор		
Модели: DRV-A301W		
Документ о соответствии:	RU Д-JP.PA01.B.86908/19	EAЭС N RU Д-JP.PA01.B.30172/20
Дата выдачи:	08.11.2019	31.03.2020
Действителен до:	07.11.2024	30.03.2025
Соответствует требованиям нормативных документов:	ТР ТС 020/2011 «Электромагнитная совместимость технических средств»	ТР ЕАЭС 037/2016 «Об ограничении применения опасных веществ в изделиях электротехники и радиоэлектроники»
Завод-изготовитель:	Cansonic Company Limited 3/F, Building 1, Guanlan Industrial Park, Grain Group, 299 Guanping Road, Dafu Community, Guanlan South, Longhua New District, Shenzhen, China(Китай)	



FCC WARNING

This equipment may generate or use radio frequency energy. Changes or modifications to this equipment may cause harmful interference unless the modifications are expressly approved in the instruction manual. The user could lose the authority to operate this equipment if an unauthorized change or modification is made.

FCC NOTE

- This equipment has been tested and found to comply with the limits for a Class B digital device, pursuant to Part 15 of the FCC Rules. These limits are designed to provide reasonable protection against harmful interference in a residential installation.
- This equipment may cause harmful interference to radio communications, if it is not installed and used in accordance with the instructions. However, there is no guarantee that interference will not occur in a particular installation. If this equipment does cause harmful interference to radio or television reception, which can be determined by turning the equipment off and on, the user is encouraged to try to correct the interference by one or more of the following measures:
 - Reorient or relocate the receiving antenna.
 - Increase the separation between the equipment and receiver.
 - Connect the equipment into an outlet on a circuit different from that to which the receiver is connected.
 - Consult the dealer or an experienced radio/TV technician for help.

This transmitter must not be co-located or operated in conjunction with any other antenna or transmitter.

IC (Industry Canada) Notice

This device contains licence-exempt transmitter(s)/receiver(s) that comply with Innovation, Science and Economic Development Canada's licence-exempt RSS(s). Operation is subject to the following two conditions:

1. This device may not cause interference.
2. This device must accept any interference, including interference that may cause undesired operation of the device.

CAUTION

This equipment complies with FCC/IC radiation exposure limits set forth for an uncontrolled environment and meets the FCC radio frequency (RF) Exposure Guidelines and RSS-102 of the IC radio frequency (RF) Exposure rules. This equipment has very low levels of RF energy that is deemed to comply without maximum permissive exposure evaluation (MPE). But it is desirable that it should be installed and operated keeping the radiator at least 20 cm or more away from person's body.

Pour le Canada

Note de 'IC (Industrie Canada)

L'émetteur/récepteur exempt de licence contenu dans le présent appareil est conforme aux CNR d'Innovation, Sciences et Développement économique Canada applicables aux appareils radio exempts de licence. L'exploitation est autorisée aux deux conditions suivantes :

1. L'appareil ne doit pas produire de brouillage;
2. L'appareil doit accepter tout brouillage radioélectrique subi, même si le brouillage est susceptible d'en compromettre le fonctionnement.

ATTENTION

Cet équipement est conforme aux limites d'exposition aux rayonnements énoncées pour un environnement non contrôlé et respecte les règles les radioélectriques (RF) de la FCC lignes directrices d'exposition et d'exposition aux fréquences radioélectriques (RF) CNR-102 de l'IC. Cet équipement doit être installé et utilisé en gardant une distance de 20 cm ou plus entre le radiateur et le corps humain.

Supplier's Declaration of Conformity

Trade Name: KENWOOD
Products: Dashboard Camera
Model Name: DRV-A301W
Responsible Party:
JVCKENWOOD USA CORPORATION
2201 East Dominguez Street,
Long Beach, CA 90810, U.S.A.
PHONE: 310 639-9000

THIS DEVICE COMPLIES WITH PART 15 OF THE FCC RULES. OPERATION IS SUBJECT TO THE FOLLOWING TWO CONDITIONS:

- (1) THIS DEVICE MAY NOT CAUSE HARMFUL INTERFERENCE, AND
- (2) THIS DEVICE MUST ACCEPT ANY INTERFERENCE RECEIVED, INCLUDING INTERFERENCE THAT MAY CAUSE UNDESIRE OPERATION.

Complies with
IMDA Standards
DB02771

Accessories

Before you get started, check you have everything below.



Dashboard Camera
(with 16GB microSD card)

Suction mount

Cigar Lighter
Adapter Cable

USB Cable

Adhesive Mount

Cable Clips

* Product appearance may differ slightly to that shown above.

Key Features

- 2.7" LCD Color Screen

We developed a screen that perfectly fits your camera, without any loss of resolution. This design allows you to use the playback feature, instantly letting you view the shot you just captured.

- Quick Release Magnetic Mount

We know how difficult it is to maintain focus with movement. We developed a mount that is uniquely designed for easy attaching and removing so you can focus on capturing the perfect shot.

- G sensor/File Protection

The dashboard camera's built-in sensor detects an outside force, forcing the device to save what has been just recorded. The file can also be manually saved. By pressing our easy to access button around the screen, you are able to save an individual file.

- Automatic Start/Stop Tech

The dashboard camera comes with built-in sensors that automatically turn the device on and off with the vehicle.

- Built-In Microphone & Speaker

A built-in microphone and speaker come standard. The feature also works with the device's playback feature.

- GPS Data

Dashboard camera is able to record your location and speed while filming with the magnetic GPS mount.

- Parking Mode

The dashboard camera has a parking mode, but a unique feature enables the device to automatically record 30 seconds of video if there is any physical movement of the vehicle. This feature requires hardwire kit CA-DR1030(optional accessory) to permanent power.

Parts Name and Functions

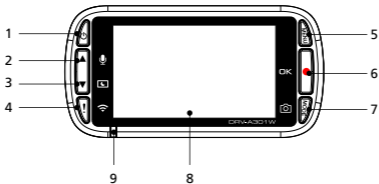

1. Power Button

Press and hold the button for 3 seconds to turn the device on/off.

2. Up/Mute Button

Up

Navigate up within menus or go to the previous file in playback mode.

Mute

Turn on or off the audio recording function while in video mode.

3. Down/Screen Off Button

Down

Navigate down within menus or go to the next file in playback mode.

Screen Off

Turn on/off the LCD screen.

4. File Protect/Wireless Link Button

File Protect

Simply press the button to protect the current video file from overwriting.

Note:

- If the button is pressed within the first third of a video clip, the previous clip will also be protected.
- If the button is pressed within the final third of a video clip, the next clip will also be protected (if recording continues).

Wireless Link

Press and hold for three seconds to turn on the Wireless Link function, this is not available while recording or during playback.

5. Menu Button

Press this button to open the menu of the current mode. Press this button twice to enter the general setting menu.

6. Record/OK Button

Record

In Video mode, press to start or stop recording.

In Photo mode, press to take a photo.

OK

The confirm button used to select options in menus.

7. Mode/Screen Shot Button

Mode

This button allows you to navigate between video, photo and playback modes.

Screen Shot

While you are recording in video mode, press the button and you will be able to take a screenshot of the current frame.

8. Screen

The device is equipped with a standard 2.7" LCD color screen to let you view.

9. Status LED Indicator

Red: Power On **Red (Flashing):** Recording **Blue:** Charging

10. Connector Port

Attach the magnetic connector to the connector port.

11. Speaker

System sound and recorded footage sound.

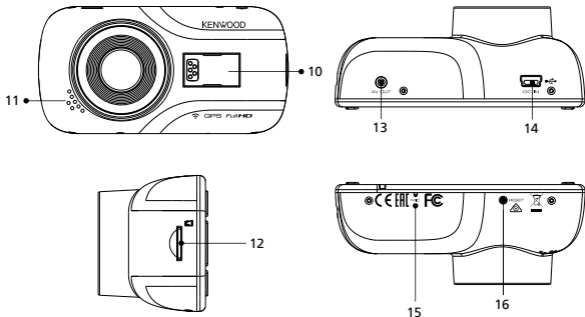

12. microSD Card Slot

Insert your microSD card here. Push your memory card into the slot until you hear a click.

(microSD card is inserted into microSD Card Slot at the factory shipment condition)

Insert Your microSD Card Into The Device

The device is designed to allow a standard microSD card to record your footage. Before installing, make sure the gold end of the card is facing the LCD screen. Once it's aligned with the slot, push the card in and listen for the CLICK that will confirm it is secure.

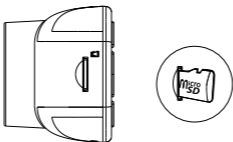

TIP:

- If you cannot hear the CLICK, take a small coin by the edge and push on the outside end of the card until the sound is made.
- Remember: DO NOT REMOVE OR INSERT THE MEMORY CARD WHILE THE DEVICE IS TURNED ON.
- The device will power off automatically when you insert or remove the SD card.

13. AV Output

The device can be connected to other screen by using the AV cable.
(commercially available)

14. DC-IN/Data transfer Port

By connecting the device with the supplied cigar lighter adapter cable you are able to charge the device. This will also be utilized to let you connect the USB cord to your computer. You can either connect the cigar lighter adapter cable with the device or magnetic connector.

15. Microphone

Built-in microphone for audio recording.

16. Reset Button

On the rare occasions the device has a problem, use the reset button to shut down the device. Simply press the reset until the device turns off and the device will automatically turn on.

Installation and Connection

Recommended installation position

- Install the device in a position where it will not block the front view of the driver (position where hidden by the rear-view mirror).
- Install the device so that it is within the wiping range of the wiper.
- Mounting the device to the center of the windshield behind the rear-view mirror will facilitate optimal video recording.



Left-hand Drive



Right-hand Drive

⚠ Caution

When passing the power cord through the front pillar or another part, observe the points below when performing the wiring work.

- Wire the power cord farther forward or farther rearward than the airbag so that it does not interfere with the airbag.
- In the case of a vehicle in which the front pillar cover is fixed in place with special clips or the like, the clips may need to be replaced after you remove the front pillar cover. For how to remove the front pillar cover, the availability of replacement parts and other information, contact the vehicle dealer.
- Fix the power cord in place with commercially available soft tape or the like so that it does not interfere with driving.

1.

1.1 CONNECT THE DEVICE TO THE MAGNETIC MOUNT

Attach the device onto **(e) the magnetic connector** on the mount.

Make sure you align the device within the connector port for proper installation.

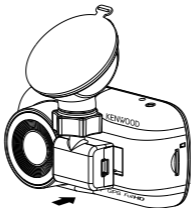

1.2 REPLACE THE SUCTION MOUNT WITH THE ADHESIVE MOUNT:

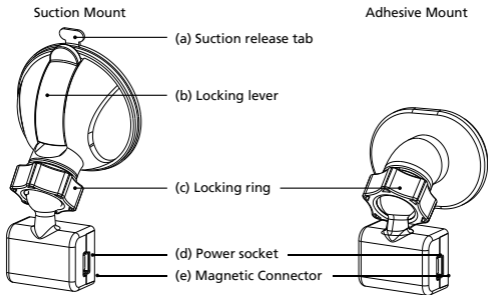

There are two types of mounts included in the package. One is a suction-cup and the other is an adhesive type. The suction mount makes it easier to attach and detach from the windshield while the adhesive mount provides more solid support for the camera.

The magnetic connector is already installed on the suction mount. If you prefer using the adhesive mount, please follow the guide below:

How to use the Adhesive Mount:

- i. Loosen the **(c) locking ring** on the suction mount and pull the **(e) magnetic connector** out.
- ii. Next, loosen the **(c) locking ring** from the adhesive mount, and plug the **(e) magnetic connector** into the adhesive mount.
- iii. Clean the installation area on the windshield and peel off the plastic covering. Adhere it to the windshield.

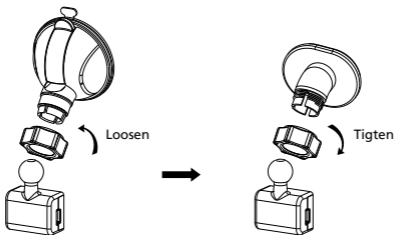

2. ATTACH THE MOUNT TO THE WINDSHIELD & START RECORDING

Remove the protective plastic film and select a position on the windshield where it won't distract you. Then, put the suction mount in place.

Release the **(b) locking lever** from the mount by pulling down on it. Hold the suction mount in place and press against the window. While holding it in place, pull the **(b) locking lever** back to lock the mount

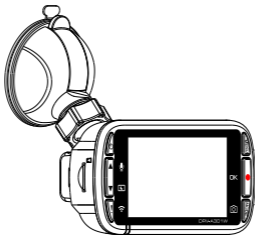

3. ADJUST THE ANGLE

Loosen the **(c) locking ring** and adjust the device to the angle you want. When you find the perfect angle, remember to tighten the **(c) locking ring** again.

4. CONNECTING TO CIGAR LIGHTER SOCKET

Connect the cigar lighter adapter cable that is in the package to your vehicle's 12 V outlet. The provided cable clips can help you keep the power cable neat.

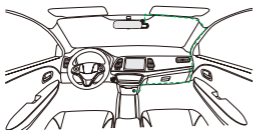

12-24V DC

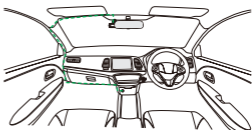

12-24V DC

Plug the cigar lighter adapter cable into the **(d) power socket** of the mount or the device. This will allow the device to begin charging.

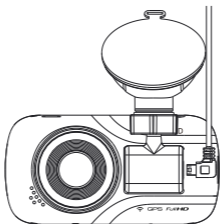

! Caution

Before performing the connection work, first check that the engine key is removed and then be sure to disconnect the negative terminal of the battery to prevent a short-circuit accident.

Initial Settings

THE FIRST-TIME SETUP

When connecting the power, the device will turn on and display the first-time setup guide below.

- Select the Language

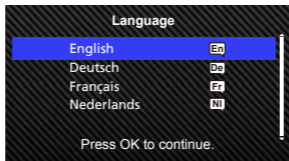

- Select the Country and Time Zone

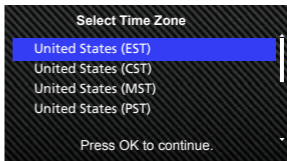
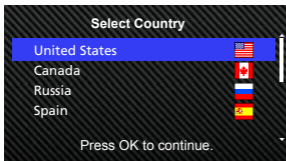

- Set the Time and Date

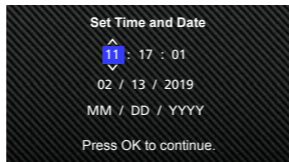

- Select the Speed Unit

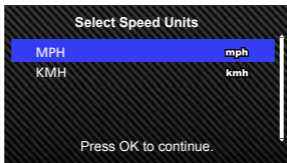

- Set Wireless Link Password

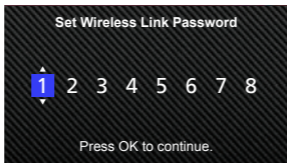

TIP:

You can reset the settings either by operating inside of the SETUP MENU, or by restoring defaults.

You can switch the capitalization by Protect button when you set the Wireless Link password.

From now on, the device will automatically turn on and start recording once power has been made available from the 12 V outlet. Just start the vehicle and start driving!

- If there is no 12 V outlet or cigar lighter socket for your vehicle, use the included USB power cord.
- DO NOT wire the device directly to the car cigar lighter socket or any 12 V outlet. Doing so will result in permanent damage to the device.
- The device has a hardwire kit CA-DR1030(optional accessory) that will directly connect to your vehicle's fuse box. This will allow you to have your 12 V outlet available for other use.

Please read carefully and follow the instructions below to help you operate the device safely.

Basic Operation

-Video Mode

The following information will help you better understand the icons in VIDEO MODE and their relative functions. Some icons show up only when corresponding functions are activated.



- 1. Mode:** Indicates the device is in video mode.
- 2. Resolution:** Displays the current resolution.
- 3. G Sensor:** The current sensitivity level of G-Sensor.
- 4. Video Length:** The duration of each video clip.
- 5. Exposure:** Indicates the current exposure level settings.
- 6. GPS:** If this icon flashes, it indicates the device is locating GPS signal.
When the GPS signal is found, the icon will stop flashing and remain stable on the screen.
- 7. Recording Duration:** This will indicate the length of the current recording.
- 8. Parking Mode Sensor:** Indicates the parking mode sensor is on.
- 9. File Protection:** Indicates the current video clip is protected.
- 10. Date:** Displays current date.
- 11. Time:** Displays current time.
- 12. Microphone:** When the audio recording function is off, there will be a red line across the icon.
- 13. Power Status:** Indicates if the device is charging or not.

The device's default settings have been set for you to use the device without needing to change the settings.

If you need to make adjustments to the settings, the following instructions will help you.

Basic Operation

-Video Menu

Access the VIDEO MENU by pressing the MENU button while in VIDEO MODE.

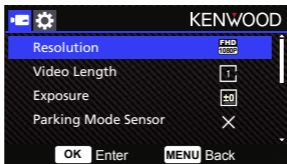

Use the **UP** and **DOWN** buttons to select setting options and press the **OK** button to enter the sub-menu.

Once you access the sub-menu, highlight the desired setting and press the **OK** button to confirm your selection and to return to the **VIDEO MENU**.

Press the **MENU** button twice to return to video mode.

TIP:

- You are not able to access the device menu while the camera is recording.
- **Resolution:** Choose the video resolution.
OPTIONS: 1080P 30fps (default)/ 720P 60fps
- **Video Length:** Set the length for each individual video clip. The video recorded by the device will be split and stored as individual video clips. The loop recording function will automatically overwrite the oldest and non-protected video clip when the memory card is full.
OPTIONS: 1 Minute (default)/3 Minutes/5 Minutes
- **Exposure:** Adjust exposure levels settings.
OPTIONS: +2/+1/ 0 (default)/-1/-2

- **Parking Mode Sensor:** Parking mode function will be available after turning on the parking mode sensor and connecting the hardware kit CA-DR1030(optional accessory) to the permanent power.

OPTION: On/Off (default)

<Normal Mode to Parking Mode>

If the device does not detect any vibration more than 5 minutes, it will turn off the device itself automatically and enter the parking mode.

<Recording at Parking Mode>

Once the device detects any vibration in the parking mode, it will turn on the device automatically and record the video for 30 seconds. In this duration, if the device detects any other vibration, it will extend recording for 30 seconds until there is no vibration at all and turn off the device back to the parking mode.

<Parking Mode to Normal Mode>

If the device detects the constant vibration more than 15 seconds, it will assume that the driver is driving the car and automatically switch from Parking Mode to Normal Mode.

- **G Sensor:** G sensor is the sensor that can detect forces. When it senses any forces, it will protect the current file automatically. Adjust the sensitivity of G sensor here.
OPTIONS: High/Medium (default)/Low/Off
- **GPS:** Turn the GPS function ON or OFF.
OPTIONS: On (default)/Off
- **Speed Units:** Adjust the unit for speed data.
OPTIONS: MPH (default)/KMH
- **Screen Saver:** the device has a function to let the screen shut down after a period of inactivity. Press any button to re-activate the display.
OPTIONS: Off (default)/30 Seconds/2 Minutes
Note: When Parking Mode is activated, after 2 minutes of recording, LCD Display will automatically turn off. (Parking mode LCD display time setting: N/A)
- **KENWOOD Stamp:** Turn the KENWOOD logo stamp ON or OFF on the recorded files.
OPTIONS: On (default)/Off
- **Time & Date Stamp:** Turn ON or OFF the date stamp mark on the recorded files.
OPTIONS: On (default)/Off
- **Information Stamp:** Turn the Information stamp including the acceleration, speed data on the recorded files ON or OFF.
OPTIONS: On (default)/Off
- **License Plate Stamp:** Input your license plate number to put your license plate stamp on the recorded files.

NOTE: When you are in the **SETUP MENU** -> **Restore Defaults**, you will be able to restore all the settings to the device's default settings.

Basic Operation

-Photo Mode

While in **VIDEO MODE**, press the **MODE** button to enter **PHOTO MODE**.

In **PHOTO MODE**, you are able to take stationary photos.

The following instructions will explain the icons in **PHOTO MODE**.

Some icons show up only when corresponding functions are activated.



1. **Mode:** Indicates when the device is in photo mode.
2. **Exposure:** Indicates the current exposure level settings.
3. **Date:** Displays current date.
4. **Time:** Displays current time.
5. **Charging Indicator:** Indicates if the device is charging or not.

Basic Operation

-Photo Menu

Access the **PHOTO MENU** by pressing the **MENU** button while in **PHOTO MODE**.

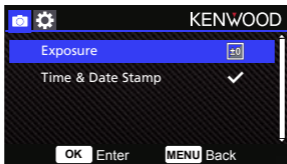

Use the **UP** and **DOWN** buttons to select setting options and press the **OK** button to enter the sub-menu.

Press the **MENU** button twice to return to **PHOTO MODE**.

- **Exposure:** Adjust exposure levels settings.
OPTIONS: +2/+1/ 0(default)/-1/-2
- **Time & Date Stamp:** Turn ON or OFF the date stamp mark on the photos.
OPTIONS: On (default)/Off

NOTE: When you are in the **SETUP MENU** -> Restore Defaults, you will be able to restore all the settings to the device's default settings.

Basic Operation

-Playback Mode

While in **PHOTO MODE**, press the **MODE** button to enter **PLAYBACK MODE**
In **PLAYBACK MODE**, you are able to review the videos and photos you have stored.

DIRECTORIES

Press the **UP** or **DOWN** buttons to navigate through the menu.

Protected: The directory for all protected videos.

Video: The directory for all unprotected videos.

Note: If the video file is protected under the playback mode, the file will move in the protected folder.

Photo: The directory for all photos.

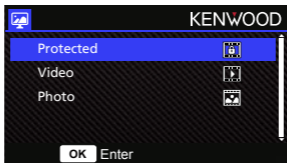

VIDEO FILES



Use the **UP** and **DOWN** buttons to select the video file and press the **OK** button to play.
Use the Protect button to protect/unprotect the video file, the file will be moved to Protect/Video folder immediately.

Video file name: The format of the video file name is `yyyymmdd_hhmmss`.

For example, 20190111_111701 mean this file was taken at January 11, 2019, 11:17:01.

The following instructions will explain the icons in Video File.



KENWOOD Stamp: Logo, can be turned on/off in VIDEO MENU

Time & Date Stamp: Date, Time, can be turned on/off in VIDEO MENU

Information Stamp: Accelerator Data, Speed, Latitude & Longitude, can be turned on/off in VIDEO MENU



1. **Mode:** Indicates when the device is in PLAYBACK MODE.
2. **File Type:** Indicates the file type is protected.
3. **Playback Progress:** Displays the current playback time.
4. **Date & Time:** Indicates the date and time of the recorded file.
5. **Playback Controls:** Use the device buttons as instructed below.



OK: PLAY/PAUSE.



MENU: DELETE or PROTECT the video.



UP: REWIND.



DOWN: FAST FORWARD.



MODE: STOP playing video and go back to Video/Protected directory.

6. **Charging Indicator:** Indicates if the device is charging or not.

7. **Protected File:** Indicates the selected file is protected.

PHOTO FILES

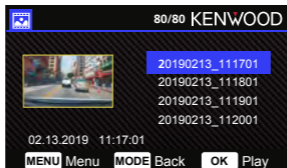

Use the **UP** and **DOWN** buttons to select the Photo file and press the OK button to play. Use the Protect button to protect/unprotect the photo file.



1. **Mode:** Indicates when the device is in PLAYBACK MODE.
2. **File Type:** Indicates the file type is photo.
3. **Date & Time:** Indicates the date and time of the recorded file.
4. **Playback Controls:** Use the device buttons as instructed below.



UP: Previous file

DOWN: Next file

5. **Charging Indicator:** Indicates if the device is charging or not.

DELETING FILES

Highlight the **DELETE** option and press the **OK** button.

TIP: PROTECTED FILES CANNOT BE DELETED.

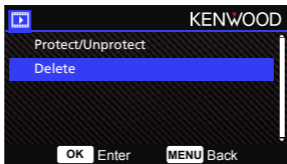

You will have the following options:

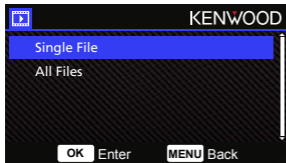

Once selected, follow the on-screen instructions to delete the current file.

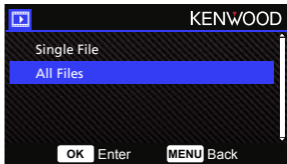

Once selected, follow the on-screen instructions to delete All files.

PROTECTING/UNPROTECTING FILES

Highlight the **PROTECT/UNPROTECT** option and press the **OK** button.

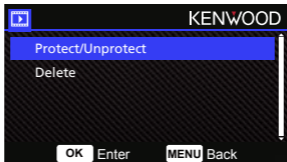

You will have the following options:

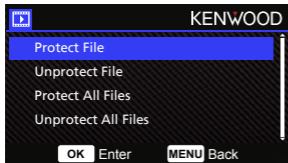

Select **Protect File**, follow the on-screen instructions to protect the current file.

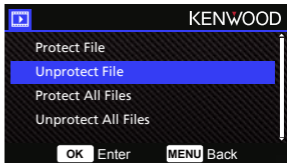

Select **Unprotect File**, follow the on-screen instructions to unprotect the current file.

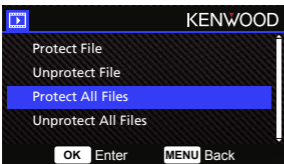

To **Protect All Files**, select the option then follow the on-screen instructions to Protect All files in the current folder.

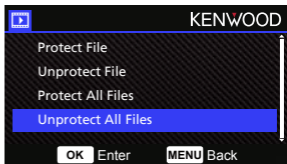

Select **Unprotect All Files**, follow the on-screen instructions to Unprotect All files in the current folder.

Settings

Access the **SETUP MENU** by pressing the **MENU** button twice.

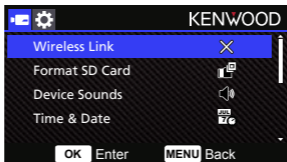

Use the **UP** and **DOWN** buttons to select setting options and press the **OK** button to enter the sub-menu.

Once you access the sub-menu, highlight the desired setting and press the **OK** button to confirm your selection and to return to the **SETUP MENU**.

Press the **MENU** button to return to the current mode.

Note: The default settings have been selected for great image quality and ease of operation. Under most circumstances, you don't need to change the settings.

Note: The setup menu cannot be accessed while the camera is recording.

- **Wireless Link:** The Wireless Link function allows you to use your smartphone to connect with the device.
OPTIONS: On/Off(default)
- **Format SD Card:** Format the memory card. Formatting will remove ALL the files in the card.
OPTIONS: Yes/No
- **Device Sounds:** Adjust the button beep sound and voice recording.
OPTIONS:
Beep: On (default)/Off
Audio Rec: On (default)/Off
- **Time & Date:** Adjust the TIME and DATE as required by using use the UP and DOWN buttons to set the value. Press the OK button to save the setting and press the MENU button to return to the SETUP MENU.
- **Time Zone/DST:** Select the time zone setting.
OPTIONS: -12/-11/-10/-9/-8/-7/-6/-5/-4/-3.5/-3/-2.5/-2/-1/GMT/
+1/+2/+3/+4/+5/+6/+7/+8/+9/+10/+11/+12

- **Language:** Select a preferred language.
 OPTIONS: English (default)/Deutsch/Français/Nederlands/Italiano/Español/Português/Русский/PolSKI/Česky/Română
- **Country:** Select a country and time zone setting.
 OPTIONS: United States/Canada/Russia/Spain/Germany/France/Italy/Netherlands/Belgium/Poland/Czech/Romania/United Kingdom/Others
- **Image Reversal:**
 Rotate the video image and the screen 180 degrees.
 OPTIONS: On/Off(default)
- **Restore Defaults:** Reset all the settings to the factory default.
- **System Info:** Displays the firmware version, card info, and GPS satellite signal.
 OPTIONS:
 System Info: Displays the firmware version and the FCC ID & IC ID.
 Wireless Link Info/Password Change: Displays the Wireless Link SSID & Password, you can also change the Wireless Link password in this setting.
 Card Info: Displays the memory card information.
 Satellite Signal: The count of how many satellite signals the device is receiving.

NOTE: Make sure the Dash Cam is not recording. Press and Hold the File Protect button and the Menu button for 3 seconds on the device to enter the System Info.



Connection with Computer

When you use the provided USB cable to connect the device to your computer, the LCD screen will show two available options.

- **USB Storage**
- **Dash Cam**

Use the UP and DOWN buttons to select the necessary function, and press the OK button to continue.

USB STORAGE

When you have connected the device to the computer, the device will operate as a card reader. Your computer will have a pop up of a new drive for you to browse all the video and photo files.

Note: The device is a “Read Only” device. If you want to copy/delete/edit the files, remove the SD card and use another card reader to connect your computer.

Remember to always turn off the device before disconnecting it from your computer.

DASH CAM

When you choose this option, the device will turn on and work normally while the device is being charged.

Note: Remember to always turn off the device before disconnecting it from your computer.

Using the Desktop Software

"KENWOOD VIDEO PLAYER" is a desktop software for displaying video recorded with the device.

System Requirements for "KENWOOD VIDEO PLAYER"

OS: Microsoft Windows 10, Windows 8.1, Windows 7*

(except for the Windows 10 Mobile, Windows RT)

*Windows 7 Service Pack 1 must be installed.

*Microsoft Visual C++ must be installed.

*DirectX XAudio2 must be installed(Windows 7 and older version).

OS: Apple Mac OS X 10.11 (El Capitan) or later

Microsoft, Windows, and DirectX are registered trademark or trademark of Microsoft Corporation in the US and other countries.

Macintosh, Mac are trademarks of Apple Inc., registered in the U.S. and other countries.

Installing the Software

Install the software in a computer environment in which you have administrator's rights.

1. Download the installer from <https://www.kenwood.com/cs/ce/>
2. Install according to the on-screen instructions.

Playback:



1. **Video time line :**
Drag the Video time line bar to Rewind or Forward to cue Video, Speed and G-Sensor date.
2. **Video play control buttons :**
Available options from left to right are stop, last clip, last frame, play, next frame next clip.
Available hot keys for individual options are
(1) Play / Pause: space
(2) Stop: esc
(3) Last frame: left
(4) Next frame: right
(5) Next clip: N
(6) Last clip: B
3. **Full screen display :**
Toggle to fit the image to the entire screen.
- Hot key: Alt + Enter
4. **Video volume adjustment :**
Drag this to change the audio volume.
- Default volume: 100%
5. **Digital zoom in / out :**
Roll the mouse wheel forward/backward on the video area or drag this to change the zoom in/out.
6. **Video play speed :**
Click to speed up / down videos on the main screen.
Available speed options may range from one quarter to quadruple to original one.
-Default speed : 1X
7. **Share Button :**
Click to open different sharing options.
8. **Video edit mode :**
Click to open the video edit function window.
9. **Screen shot :**
Click to capture the current image displayed on the main screen and save the file in a given space.
-Default location : installation root directory /Snapshot.
10. **Speed :**
Display the speed of the car in the video when it was recorded. You may change the UOM of speed under Setup → Speed Unit.
(Function available on the device with built-in GPS)
-Unit of measure (UOM) option : Imperial Unit or Metric Unit
-Default unit of measure : MPH
11. **G-sensor data :**
Display the G-data of the vehicle in the video when it was recorded.
12. **Chart of G-sensor data :**
Display the G-data of the vehicle in the video when it was recorded.
13. **Video shot on :**
Display date and time of the video when it was recorded.
14. **Latitude :**
Display the latitude of the video where it was recorded.
(Function available on the device with built-in GPS)
15. **Longitude :**
Display the longitude of the video where it was recorded.
(Function available on the device with built-in GPS)
16. **Driving direction :**
Display the direction of the video where it was recorded.
(Function available on the device with built-in GPS)
17. **Average Speed :**
Display the average speed of the video where it was recorded.
(Function available on the device with built-in GPS)
18. **Max Speed :**
Display the max speed of the video where it was recorded.
(Function available on the device with built-in GPS)
19. **Google Maps :**
Display the location of the video where it was recorded.
(Function available on the device with built-in GPS)
20. **Add the file / Remove the file :**
Click the "Add" key to display the "add file" window. Click the "Remove" key to erase the selected files from the playlist.
21. **File group / File ungroup :**
You may group multiple files into the playlist then play them in one file and link the data of each file to display in data table. For example, adding 5 1-minute length files into one group will end up with a 5 minutes display time shown in the data table. The name of a group is a string of the name of the first file suffixed with the number of files in the group. That is, for a group of 5 files with the first name "20180925_191823", the name of the group is "20180925_191823(5)".
22. **Video playlist :**
A video thumbnail will show in this table after the videos added in the list.

How to Edit the Video:



1. Edit the timeline of the video by moving the white block on the timeline to set up the edit scope of video.
2. Edit scope of the video. You may input a number to change the size of this scope.
3. Confirm and click to validate the current work and proceed with the next step.
4. Click to exit the video edit mode.
5. The software system bar and video playlist stop functioning in video edit mode.



1. **Remove audio file:**
Check to remove the audio file of the exported video.
2. **Remove the GPS and G-sensor data:**
Check to remove the GPS and G-sensor file of the exported video.
3. **Image export:**
Select the target storage location of the image file and its name.
Default location: installation root directory / Edit video



1. **Image processing:**
Proceed with image processing once the image export options are setup.
2. **Export status (1):**
The image file export progress is presented as a percentage symbol "%" and is synced with item 3.
3. **Export status (2):**
The image file export progress is presented by a frame being filled with layered colors ink and synced with item 2. The export is finished once the frame is fully inked in layered colors.



1. **OK:**
Click to go back to the play mode page.
2. **Open folder:**
Click to open folders with image files saved in there.

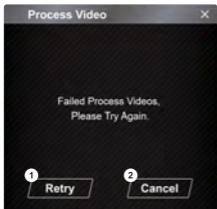

1. **Retry:**
Click to export the image file again with the previous settings.
2. **Cancel:**
Click to abort image file export and go back to the video edit page.

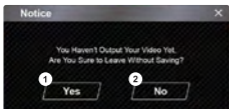

1. **Yes:**
Click to go back to the play mode page.
2. **No:**
Click to abort image file export and go back to the video edit page.

-Share Mode

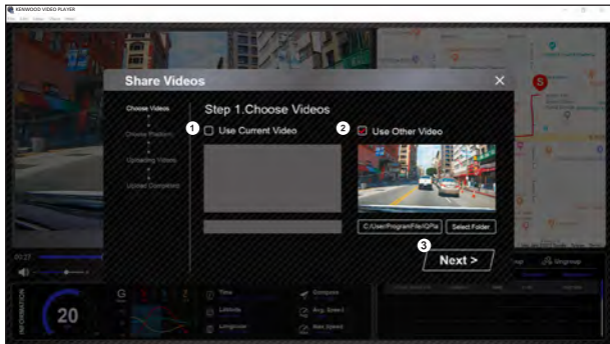

Click Share → Share Videos in the software system bar at the top of the window or the community sharing icon in the interface to display the sharing window.

- 1. To share the current video:**
When two files are playing, the one with the active speaker icon will be shared.
- 2. To share the non-current video:**
Click and open the file selection window.
- 3. Next step:**
Click to go to the next step.

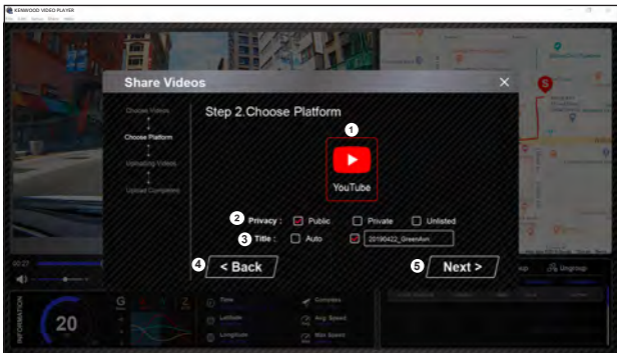

- 1. Select a community platform:**
You can select just one community platform and the one being selected will be circled in layered colors.
- 2. Select the privacy mode:**
You can select the privacy mode of Public, Private, and Unlisted when you upload the video.
- 3. Upload title:**
The title item will define the name of the video when you upload the video, you can select the Auto: "DD/MM/YYYY (default) – Dash Cam – KENWOOD VIDEO PLAYER" or define the title by yourselves.
- 4. Last step:**
Click to go back to the last step.
- 5. Next step:**
Click to go to the next step.

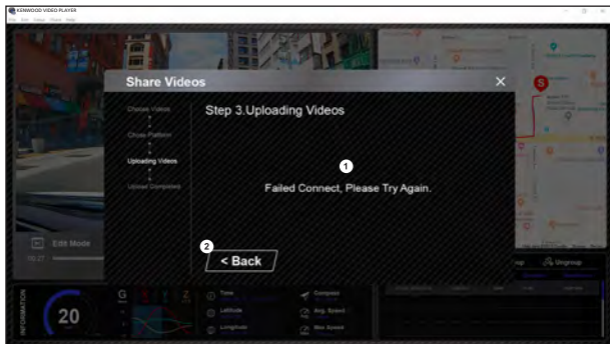

- 1. File upload failure:**
This page displays if an upload failed or there is a server connection timeout.
- 2. Last step:**
Click to go back to the last step.

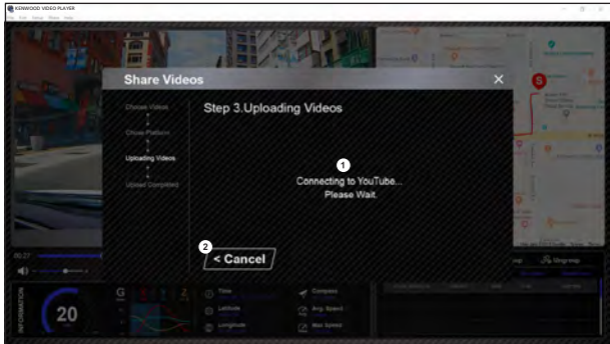

- 1. Connect to community platform:**
The message "Connecting to Social Media..... Please Wait." displays when a connection is being initiated. Your default browser will display and connect to the selected community platform. You are required to bundle your account ID with the platform for connection the first time only (no longer needed once bundled).
- 2. Cancel:**
Click to go back to the last step.

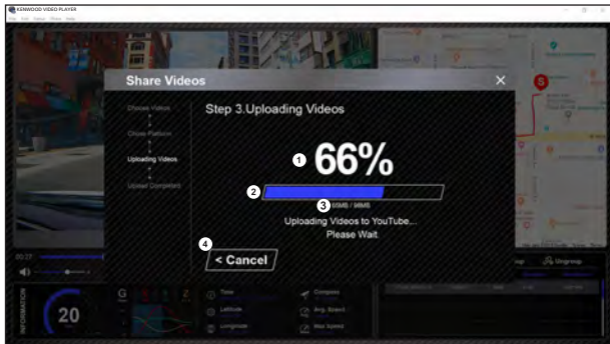

- 1. Upload status (1):**
The file upload progress is presented as a percentage symbol "%" and synced with item 2.
- 2. Upload status (2):**
The file upload progress is presented by a frame being filled with layered colors ink and synced with item 1. The file is uploaded successfully once the frame is fully inked in layered colors.
- 3. Upload progress:**
The former number is the MB uploaded and the latter is the total for the upload.
- 4. Cancel:**
Click to go back to the last step.

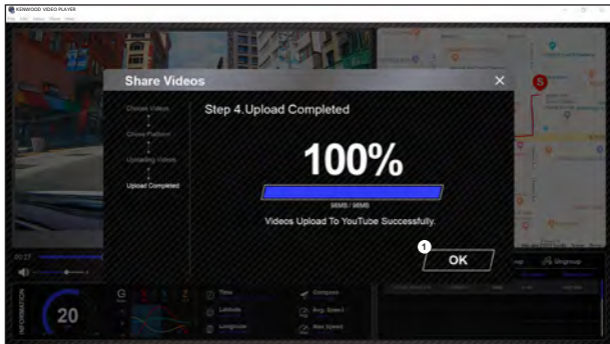

1. **Confirm:**
Click to go back to play mode information.

Using the Smartphone App

"KENWOOD DASH CAM MANAGER" is a smartphone app for displaying video recorded with the device.

System Requirements for "KENWOOD DASH CAM MANAGER"

OS: Android 5.0.2 or later

OS: iOS 9.0 or later

Android is a trademark of Google Inc. in the U.S. and other countries.

iOS is a trademark or registered trademark of Cisco in the U.S. and other countries.

-Installing the Smartphone App

Download and install the app from App Store(iOS)/Google Play(Android) on your mobile device

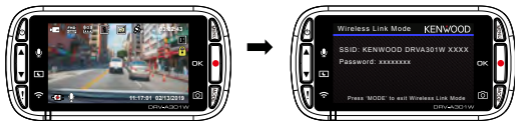

Make sure the Dash Cam is not recording. Press and Hold the Wireless Link button on the device to enter the pairing mode.

The following information will help you better understand the app and their relative functions.

How to Connect:

1. Long press the Wireless Link button on the device and enter the connecting mode.

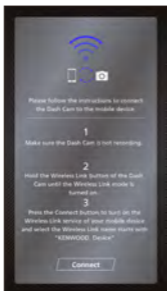

2. Open the KENWOOD DASH CAM MANAGER of the smartphone app.
3. Press the Connect button and select from the network list to pair the dashboard camera device.
4. Enter the Wireless Link password into the input field.
5. Connect completed, press the Continue button into the main screen of app.

-Main Screen



1. Dashboard Camera Live View

Live view of the dashboard camera.
Press to move to live view screen.

2. Files On Dash Cam

The video and photo files which are saved in the SD card.

3. Dash Cam Menu

Press this icon to open the dashboard camera's menu settings.

4. Files On Mobile

The video and photo files which are downloaded into the smartphone.

5. About

Displays the dashboard camera firmware version and app's information.

-Preview

Click the preview display to enter the video mode, and click the video/photo icon to switch between these two modes. By clicking the red dot to start/stop recording and the white dot to take photos.



- 1. Back Button**
Back to main screen.
- 2. Dashboard Camera Image Preview**
Displays the streaming of the dashboard camera.
- 3. Video Mode**
Press it to switch to video mode.
- 4. Photo Mode**
Press it to switch to photo mode.
- 5. Status Bar**
Video mode: Recording duration.
Photo mode: Remaining shot count.
- 6. Shutter**
Video mode: Start/stop recording.
Photo mode: Take a picture.

-Files on Dash Cam

Click Files on Dash Cam to enter the Video Playback mode to review, protect/unprotect, and delete the files saved in the SD card. In addition, you can also download the important files to your mobile device.



- 1. Back Button**
Back to main screen.
- 2. Video/Image**
Play/Pause the video.
- 3. Time Line**
The time line for current video.
- 4. Switch Display Video/Image File**
Press the button to switch display file on the playback list.
- 5. Playback List**
The playback list will display the video or image from the dashboard camera.
- 6. Edit Mode**
Press the button to edit mode.
- 7. Protect/Unprotect**
Protect/Unprotect the selected file on the dashboard camera.
- 8. Delete**
Delete the selected file on the dashboard camera.
- 9. Download**
Download the selected file to the smartphone.

-Files on Mobile

Click Files on Mobile to enter the Local Video Playback mode to review the downloaded videos with Google Maps, and also view the user's route, speed, G-sensor and distance data. You can also shorten the video by using the edit function and share it to the other social media apps installed in your mobile device.



1. Back Button

Back to main screen.

2. Video/Image

Play/Pause the video.

3. Time Line

The time line for current video.

4. Playback List

The playback list will display the video or image from the dashboard camera.

5. Edit Mode

Press the button to edit mode.

6. Switch Display Video/Image File

Press the button to switch display file on the playback list.

7. GPS Information

Press the button to turn on the GPS information, it will show the speed, G-sensor, and the distance.
Note: This feature only work when the video had GPS data.

8. Google Maps

Press the button to turn on the map.
Note: This feature only works when the video had GPS data.

9. Protect/Unprotect

Protect/Unprotect the selected file on the smartphone.

10. Delete

Delete the selected file on the smartphone.

11. Share Video/Image

Share the selected file to the other social media apps installed in your smartphone.

12. Cut Video

Cut video to adjust the video length.
Note: Video only.

-How to Edit the Video:

1. Files on Mobile Device.



2. Press the Edit Mode button.

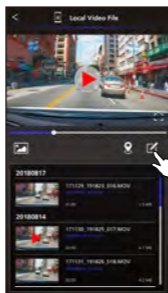

3. Select the video.

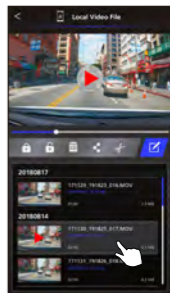

4. Press the Edit button and then press the Cut button.

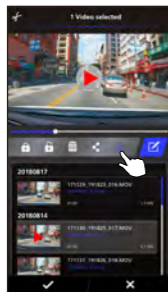

5. Select the area of video.

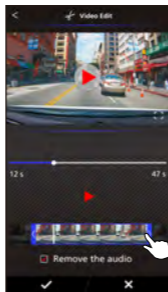

6. Press the Check button to output the video.

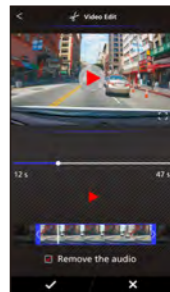

-How to Share the Video:

1. Files on Mobile.



2. Press the Edit Mode button.

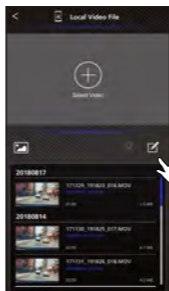

3. Select the video.

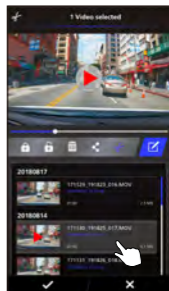

4. Press the Share button and press the Check button.



5. Select the social media apps installed in your smartphone.

Android

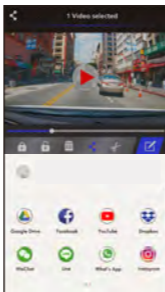

IOS

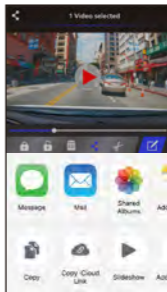

-Menu

Click Menu to enter the Video/Photo/General menu and adjust settings. Switch between these three menu by clicking the icons at the bottom.

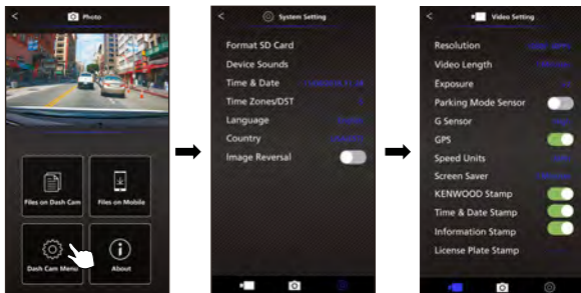

-About

Click About icon to view the software version and the app's information.



Troubleshooting

Blurred Image (Video)	The device comes with a protective lens cover for the camera lens, be sure to remove it. Wipe the lens with a soft cloth until any debris/stains are removed. Clean your vehicles windshield where the camera is placed.
Unable to insert SD card	Make sure the metal portion of the memory card faces the screen side. Once inserted, push the card until a CLICK sound is heard.
SD card does not release from the devices	The device releases the SD Card by pressing the SD card forward. By applying the pressure on the SD card, a small click sound will be made. If you are unable to remove the SD card, use the edge of a small coin to push forward until the click sound is made.
Video files can not be played	The device video files are recorded in .mp4 format. These files may not be played on your computer if you do not have a suitable video player installed.
Video files jump when they are being played	The memory card that the device recommends for best quality is the Class 10 SD Card. If your computer does not recognize the video files, try another computer to view the recorded video. Copy the video file on to the computer and allow for the computer video player rather than the device Playback feature.
The photos come out blurry	Be sure to hold the device still while you take your photo. Reminder: The photo is not taken unless you have heard the shutter click. Also make sure the protective lens cover is removed and the lenses are clean.
The total video recording time is only a few minutes long	You may have a small amount of available space left for your SD card. Back up all the files you need from the SD card. Only AFTER you back up all the files you need, format the SD card with the device.
I cannot save my video files to my computer through the USB storage feature	The functions have been optimized to work properly with both Windows and Mac computers. Please reboot your computers. Make sure the device is connected properly.
The suction cup does not attach to the surface	Be sure the protective film on the suction cup has been removed. Before you place it, make sure the surface is clean and smooth. Wipe down the surface and add a small amount of moisture to the suction cup to allow for a stronger bond. Do not apply on a non-smooth surface or an area with paint.

<p>The device shuts down on its own</p>	<p>Auto power off function will turn off the device automatically after it loses its power supply. Make sure the device is connected properly to the car power cable.</p>
<p>The device does not charge in my car</p>	<p>If your cigar lighter adapter cable is not working properly with your device, check your car's power fuses. Also check your power cord and replace it if there is an issue.</p>
<p>SD Card is not letting me view my files</p>	<p>Try some different card readers and computers to see if any of them can view the files. If none of them work, the files are probably damaged. Use the device to format the memory card.(WARNING: formatting the memory card will remove all the files saved), We recommend the branded memory cards with Class 10. Note: You must format the SD card with the device for first time use.</p>
<p>I cannot delete the file on the device</p>	<p>Be sure the file you are trying to delete is unprotected. If the file is protected, please follow the instruction on page 29 to unprotect the file first, and then delete the file.</p>
<p>My screen turns off after I just turned it on</p>	<p>The screen saver function turns off the screen after a period of inactivity. If you want to turn off this function, go to SETUP menu -> Screen Saver, and turn it off.</p>
<p>The message "Please Format SD Card" appears on my screen</p>	<p>The device requires formatting the SD card if the card is used on the device for the first time. Please format the SD card in the SETUP menu.</p>
<p>The device does not charge</p>	<p>Be sure the power cord is connected properly. When the device is being charged, the blue LED indicator will illuminate.</p>
<p>A "Card Error" message appears on my device</p>	<p>This indicates that the SD card is not properly formatted to your device. Please remove the files you would like to keep on to your computer, and perform a "Format SD Card" procedure to allow your memory card to function properly with the device.</p>
<p>A "Card Full" message appears on my device</p>	<p>When this message appears, your SD card is at full capacity. Reminder: When you have protected files, you limit the use of your memory card. Delete unnecessary files to allow maximum use of your memory card.</p>
<p>The device always turn on by itself.</p>	<p>The parking mode function will automatically start recording a 30 second video clip and turn off when external forces are detected. If you want to turn off this function, go to SETUP menu -> Parking Mode Sensor, and turn it off.</p>

I press the MENU button but nothing happens	Reminder: The device will not let you access the menu while it is recording. To access the menu, stop recording and the MENU feature will be accessible.
When I download files from the KENWOOD website a malicious software message appears	If this message appears, simply adjust your browser settings and allow for the download to proceed. Once complete, reset your browser security to protect your computer.
Unresolved Issues	If you continue to have problems with your device, please reset your device to default settings in the setup menu and begin the process over again. If these problems remain, Please contact your store of purchase or a service center.

Appendix

About the monitor screen

- Do not subject the screen section to strong shocks. Doing so could damage the screen.
- Do not let direct sunlight shine on the screen. Leaving the screen with direct sunlight shining on it for long periods of time will increase the temperature and could damage the screen.
- Extremely high or low temperatures could cause the display to operate slowly or darken, or result in residual images. This is due to the properties of liquid crystal displays and is not a malfunction. Normal operation will return once the temperature in the car returns to normal.
- There may be small dots on the screen. This is a phenomenon typical of liquid crystal displays and is not a malfunction.
- Due to the properties of liquid crystal displays, the display may be hard to see depending on the angle at which it is viewed, but this is not a malfunction.

Wireless Link Specification

Standard	IEEE802.11n
Security	WPA2
Frequency Range	2400-2483MHz ISM band
Transfer Rate	150Mbps (802.11n)
Output Power	13dBm±2dB (802.11n)

On Wireless Link Security

The Wireless Link communicating with radio wave, there is a benefit that you are able to access Link freely as far as the radio wave reaches. On the other hand, without security setting there may be a risk of hacking or abusive invasion by a malignant third party. We recommend that you use Wireless Link after setting security of the devices connected. Please be noted that we are not liable for any damage or troubles pertaining to security when using this function.

Radio Interference with Bluetooth Devices

With the Wireless Link in use, if Bluetooth devices are in operation nearby, there may be radio interference causing lowered traffic speed or disconnect. In this case please do not use the devices simultaneously.

About SD Cards

- Cards supported by this device

Standard	microSDXC / microSDHC
Capacity	8 GB to 256 GB
Speed Class	Class 10
File System	exFAT/FAT32

- Up to the Class 10 speed class is supported.

Precaution for using SD cards

- When using a commercially available SD card, also check the instructions supplied with the SD card.
- Be sure to format (initialize) an SD card with the device before use.
- SD cards have a product lifespan, such as the number of times that writing can be performed. It is recommended to replace the SD card with a new one regularly depending on the usage conditions.
- When inserting and removing an SD card, confirm the orientation, do not bend it, and do not apply a strong force or impact to it.
- Do not directly touch the contact part with a hand or metal. The stored data may be damaged or lost due to static electricity.
- Be sure to back up (copy) the required files in the SD card to a computer or other device. The saved data may be lost due to the usage conditions of the SD card. Please note that JVCKENWOOD cannot compensate for any damages arising from the loss of saved files.

Requests Regarding Disposal or Transferring Ownership of an SD Card

Using the SD card format and deletion functions of this device or formatting with a function of a computer just changes the file management information and does not completely delete the data in a SD card. We recommend either physically destroying the actual SD card or using commercially available PC data deletion software or the like to completely delete the data in the SD card before disposal or transfer of ownership. Manage the data in SD cards at your own responsibility.

Important Notices Regarding Trademarks and Software

- microSDXC logo is a trademark of SD-3C LLC.
- Microsoft, Windows and DirectX are registered trademark or trademark of Microsoft Corporation in the US and other countries.
- Macintosh, Mac are trademarks of Apple Inc., registered in the U.S. and other countries.
- ©2019 Google LLC All rights reserved. Google Maps™ is registered trademarks of Google LLC.
- Android is a trademark of Google Inc. in the U.S. and other countries.
- iOS is a trademark or registered trademark of Cisco in the U.S. and other countries.

Important Notice Concerning the Software

About Open Source Software included in the Desktop Software

The KENWOOD VIDEO PLAYER includes certain open source or other software originating from third parties that is subject to the GNU Lesser General Public License version 2.1 (LGPLv2.1) and different copyright licensees, disclaimers and notices. The source code of software licensed under LGPLv2.1 and different copyright licenses, disclaimers and notices are distributed at the website below, <http://www.kenwood.com/gpl>.

• FFmpeg

This software uses libraries from the FFmpeg project (<http://ffmpeg.org/>) under the LGPLv2.1 License: GUN Lesser General Public License (LGPL) version 2.1

• NSIS

This software's installer is made using NSIS (<http://nsis.sourceforge.net>) which is licensed under zlib/libpng license.

Specifications

Model Number / Name	DRV-A301W / GPS Integrated Dashboard Camera
Power Requirements	5V / 2A; 12-24V DC
Power Supply (Car power cable)	Input: 12-24V DC Output: 5V DC Fuse Type: 32mm/2A
Current Consumption	380mA
Sensor Resolution	2.13M Pixel
Lens Type/Angle/Aperture	6G / 136° / F1.8
Recording Resolution	FHD 1920 x 1080 @ 30fps (default)
Screen Size	2.7"
Screen Resolution	960 (W) X 240 (H) pixels x RGB
Screen Ratio	16:9
Card Reader	microSDXC / SDHC, up to 256GB
SD Card (Recommended Type)	microSDXC/SDHC card 8GB to 256GB supported, Class 10 recommended for best results use a recognized brand
SD Card Recorded File Capacity (based on default settings)	8GB microSD = 60 mins (1 minute x 60 recordings) 16GB microSD = 120 mins (1 minute x 120 recordings) 32GB microSD = 240 mins (1 minute x 240 recordings) 64GB microSD = 480 mins (1 minute x 480 recordings) 128GB microSD = 960mins (1 minute x 960 recordings) 256GB microSD = 1920 mins (1 minute x 1920 recordings)
Recording Format	H.264(MP4)
Unit Dimensions	3-5/8" x 1-13/16" x 1-7/16" / 92mm x 46mm x 37mm
Unit Weight	2.9oz / 82g

KENWOOD