



PHONES

(044) 338-0-130
(050) 332-0-130
(063) 577-0-130
(067) 353-0-130

130
COM.UA

Internet store of
autogoods



SKYPE
km-130

CAR RECEIVERS — Receivers • Media receivers and stations • Native receivers • CD/DVD changers • FM-modulators/USB adapters • Flash memory • Facia plates and adapters • Antennas • Accessories |
CAR AUDIO — Car audio speakers • Amplifiers • Subwoofers • Processors • Crossovers • Headphones • Accessories | TRIP COMPUTERS — Universal computers • Model computers • Accessories |
GPS NAVIGATORS — Portable GPS • Built-in GPS • GPS modules • GPS trackers • Antennas for GPS navigators • Accessories | VIDEO — DVR • TV sets and monitors • Car TV tuners • Cameras • Videomodules
• Transcoders • Car TV antennas • Accessories | SECURITY SYSTEMS — Car alarms • Bike alarms • Mechanical blockers • Immobilizers • Sensors • Accessories | OPTIC AND LIGHT — Xenon • Bixenon • Lamps
• LED • Stroboscopes • Optic and Headlights • Washers • Light, rain sensors • Accessories | PARKTRONICS AND MIRRORS — Rear parktronic • Front parktronic • Combined parktronic • Rear-view mirrors
• Accessories | HEATING AND COOLING — Seat heaters • Mirrors heaters • Screen-wipers heaters • Engine heaters • Auto-refrigerators • Air conditioning units • Accessories | TUNING — Vibro-isolation
• Noise-isolation • Tint films • Accessories | ACCESSORIES — Radar-detectors • Handsfree, Bluetooth • Windowlifters • Compressors • Measuring instruments • Cleaners • Carsits
• Miscellaneous | MOUNTING — Installation kits • Upholstery • Grilles • Tubes • Cable and wire • Tools • Miscellaneous | POWER — Batteries • Converters • Start-charging equipment • Capacitors
• Accessories | MARINE AUDIO AND ELECTRONICS — Marine receivers • Marine audio speakers • Marine subwoofers • Marine amplifiers • Accessories | CAR CARE PRODUCTS — Additives • Washer fluid •
Care accessories • Car polish • Flavors • Adhesives and sealants | LIQUID AND OIL — Motor oil • Transmission oil • Brake fluid • Antifreeze • Technical lubricant



In store "130" you can find and buy almost all necessary goods for your auto in Kyiv and other cities, delivery by ground and postal services. Our experienced consultants will provide you with exhaustive information and help you to chose the very particular thing. We are waiting for you at the address

<http://130.com.ua>

KENWOOD

DNX8170DABS DNX7170DABS DNX5170DABS DNX5170BTS DNX317DABS DNX317BTS

GPS NAVIGATION SYSTEM INSTRUCTION MANUAL

JVC KENWOOD Corporation

- Updated information (the latest Instruction Manual, system updates, new functions, etc.) is available from <http://www.kenwood.com/cs/ce/>.
- The Instruction manual is subject to change for modification of specifications and so forth. Be sure to download the latest edition of the Instruction manual for reference. <http://manual.kenwood.com/edition/im392/>



Contents

Before Use 4

Precautions.....	4
Safety Precautions and Important Information	5
How to read this manual	6

Basic Operations 7

Functions of the Buttons on the Front Panel ...	7
Turning on the Unit	9
Initial Settings.....	10
Adjusting the volume	12
Monitor Angle Control	12
Detaching The Front Panel.....	13
Touch screen operations	13
HOME screen descriptions.....	14
Source selection screen descriptions.....	14
Source control screen descriptions	16
Popup menu	17
List screen	18
Navigation Operation	18

Disc 22

Playing a disc	22
DVD/ VCD Basic Operation.....	22
Music CD/ Disc media Basic Operation	24
Search Operation (Disc media only).....	25
DVD Disc Menu Operation.....	25
DVD Setup.....	26

USB/SD card 27

Connecting a USB device	27
Inserting the SD card	28
USB/SD card Basic Operation.....	28
Search Operation.....	30

iPod/iPhone 31

Preparation	31
iPod/iPhone Basic Operation	32
Search Operation.....	33

APPS—Android Auto™/ Apple CarPlay/Mirroring 34

Mirroring Operation	34
Apple CarPlay Operation	35
Android Auto™ Operation	37
Spotify Operation.....	38

Radio 40

Radio Basic Operation	40
Memory Operation	41
Selecting Operation	42
Traffic Information	42
Tuner Setup.....	43

DAB 43

DAB Basic Operation	43
Storing Service in Preset Memory	45
Selecting Operation	45
Traffic Information	46
Replay.....	46
DAB Setup.....	47

Bluetooth Control 48

Information for using Bluetooth® devices.....48
Register from the Bluetooth unit.....49
Bluetooth Setup.....50
Playing Bluetooth Audio Device.....52
Using Hands-Free Unit.....54
Hands-Free Setup.....58

Other External Components 59

View Camera59
Use Dashboard Camera.....61
External audio/video players—AV-IN61
HDMI/ MHL source.....61
TV tuner62

Setting Up 62

Monitor Screen Setup.....62
System Setup63
User Interface Setup.....63
Special Setup65
Display Setup.....66
AV Setup68

Controlling Audio 68

Speaker/ X'over setup69
Controlling General Audio.....71
Equalizer Control.....71
Volume Offset.....72
Zone Control73
Sound Effect.....73
Listening Position/ DTA.....74

Connection/Installation 76

Before Installation76
Installing the unit77

Troubleshooting 84

Problems and Solutions84
Error Messages85

Appendix 86

Playable Media and Files.....86
Region Codes in the World88
DVD Language Codes.....89
Specifications.....90
About this Unit.....93

Remote control 98

Battery Installation.....98
Functions of the Remote control Buttons99

Before Use

Precautions

⚠ WARNINGS

📌 To prevent injury or fire, take the following precautions:

- To prevent a short circuit, never put or leave any metallic objects (such as coins or metal tools) inside the unit.
- Do not watch or fix your eyes on the unit's display when you are driving for any extended period.
- If you experience problems during installation, consult your KENWOOD dealer.

📌 Precautions on using this unit

- When you purchase optional accessories, check with your KENWOOD dealer to make sure that they work with your model and in your area.
- You can select language to display menus, audio file tags, etc. See **User Interface Setup (P.63)**.
- The Radio Data System or Radio Broadcast Data System feature won't work where the service is not supported by any broadcasting station.
- The unit may not function properly if the connectors between the unit and front panel are dirty. Detach the front panel and clean the connector with a cotton swab gently, being careful not to damage the connector.

📌 Protecting the monitor

- To protect the monitor from damage, do not operate the monitor using a ball point pen or similar tool with the sharp tip.

📌 Cleaning the unit

- If the faceplate of this unit is stained, wipe it with a dry soft cloth such as a silicon cloth. If the faceplate is stained badly, wipe the stain off with a cloth moistened with neutral cleaner, then wipe it again with a clean soft dry cloth.

NOTE

- Applying spray cleaner directly to the unit may affect its mechanical parts. Wiping the faceplate with a hard cloth or using a volatile liquid such as thinner or alcohol may scratch the surface or erase screened print.

📌 Lens fogging

When you turn on the car heater in cold weather, dew or condensation may form on the lens in the disc player of the unit. Called lens fogging, this condensation on the lens may not allow discs to play. In such a situation, remove the disc and wait for the condensation to evaporate. If the unit still does not operate normally after a while, consult your KENWOOD dealer.

📌 Precautions on handling discs

- Do not touch the recording surface of the disc.
- Do not stick tape etc. on the disc, or use a disc with tape stuck on it.
- Do not use disc type accessories.
- Clean from the center of the disc and move outward.
- When removing discs from this unit, pull them out horizontally.
- If the disc center hole or outside rim has burrs, use the disc only after removing the burrs with a ballpoint pen etc.
- Discs that are not round cannot be used.

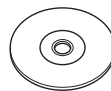

- 8-cm (3 inch) discs cannot be used.
- Discs with coloring on the recording surface or discs that are dirty cannot be used.

- This unit can only play the CDs with



- This unit may not correctly play discs which do not have the mark.
- You cannot play a disc that has not been finalized. (For the finalization process see your writing software, and your recorder instruction manual.)

Acquiring GPS signal

The first time you turn on this unit, you must wait while the system acquires satellite signals for the first time. This process could take up to several minutes. Make sure your vehicle is outdoors in an open area away from tall buildings and trees for fastest acquisition.

After the system acquires satellites for the first time, it will acquire satellites quickly each time thereafter.

About the front panel (DNX8 DNX7)

When removing the product from the box or installing it, the front panel may be positioned at the angle shown in (Fig. 1). This is due to the characteristics of mechanism the product is equipped with.

When the product is first powered on works properly, the front panel will automatically move into the position (initial setting angle) shown in (Fig. 2).



(Fig. 1)



(Fig. 2)

Remote controller

This unit can be operated using the remote control KNA-RCDV331 (optional accessory). For more information about KNA-RCDV331, download the latest version of the Instruction Manual from <http://manual.kenwood.com/edition/im392/>

Safety Precautions and Important Information

Read this information carefully before starting to operate the KENWOOD Car Navigation System and follow the instructions in this manual. Neither KENWOOD nor Garmin shall be liable for problems or accidents resulting from failure to observe the instructions in this manual.

▲ WARNING

Failure to avoid the following potentially hazardous situations could result in an accident or collision resulting in death or serious injury.

When navigating, carefully compare information displayed on the navigation system to all available navigation sources, including information from street signs, visual sightings, and maps. For safety, always resolve any discrepancies or questions before continuing navigation.

Always operate the vehicle in a safe manner.

Do not become distracted by the navigation system while driving, and always be fully aware of all driving conditions. Minimize the amount of time spent viewing the screen of the navigation system while driving, and use voice prompts when possible.

Do not enter destinations, change settings, or access any functions requiring prolonged use of the navigation system controls while driving. Stop your vehicle in a safe and legal manner before attempting such operations.

Keep the system volume at a low enough level to be able to hear outside noises while driving. If you can no longer hear outside noises, you may be unable to react adequately to the traffic situation. This may cause accidents.

The navigation system will not display the correct current position of the vehicle the first time it is used after purchase, or if the vehicle battery is disconnected. GPS satellite signals will soon be received, however, and the correct position will be displayed.

Be careful of the ambient temperature. Using the navigation system at extreme temperatures can lead to malfunction or damage. Also note that the unit can be damaged by strong vibration, by metal objects, or by water getting inside the unit.

⚠ CAUTION

Failure to avoid the following potentially hazardous situations may result in injury or property damage.

The navigation system is designed to provide you with route suggestions. It does not reflect road closures or road conditions, weather conditions, or other factors that may affect safety or timing while driving.

Use the navigation system only as a navigational aid. Do not attempt to use the navigation system for any purpose requiring precise measurement of direction, distance, location, or topography.

The Global Positioning System (GPS) is operated by the United States government, which is solely responsible for its accuracy and maintenance. The government system is subject to changes that could affect the accuracy and performance of all GPS equipment, including the navigation system. Although the navigation system is a precision navigation device, any navigation device can be misused or misinterpreted and, therefore, become unsafe.

📄 IMPORTANT INFORMATION

Vehicle Battery Preservation

This navigation system can be used when the ignition key is turned to ON or ACC. To preserve the battery, however, it should be used with the engine running whenever possible. Using the navigation system for a long time with the engine switched off can cause the battery to run down.

Map Data Information

One of the goals of Garmin is to provide customers with the most complete and accurate cartography that is available to us at a reasonable cost. We use a combination of governmental and private data sources, which we identify in product literature and copyright messages displayed to the consumer. Virtually all data sources contain some inaccurate or incomplete data. In some countries, complete and accurate map information is either not available or is prohibitively expensive.

How to read this manual

- The screens and panels shown in this manual are examples used to provide clear explanations of the operations. For this reason, they may be different from the actual screens or panels used, or some display patterns may be different.
- In this manual, each model name is abbreviated as follows.
 - DNX8170DABS: **DNX8**
 - DNX7170DABS: **DNX7**
 - DNX5170DABS/ DNX5170BTS: **DNX5**
 - DNX317DABS/ DNX317BTS: **DNX3**If above icons are showed, read the article applicable to the unit you use.
- **Indication language:** English indications are used for the purpose of explanation. You can select the indication language from the **SETUP** menu. See **User Interface Setup (P.63)**.

Basic Operations

Functions of the Buttons on the Front Panel

DNX8170DABS/ DNX7170DABS

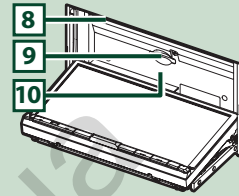
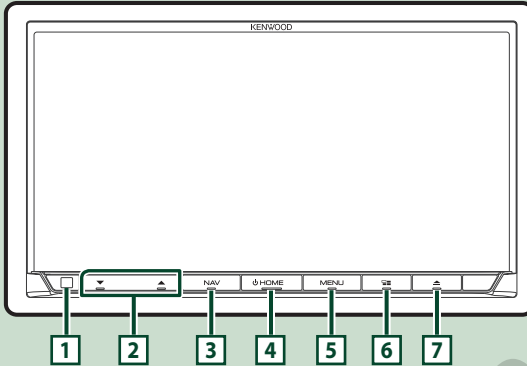

NOTE

- The panels shown in this guide are examples used to provide clear explanations of the operations. For this reason, they may be different from the actual panels.
 - In this manual, each model name is abbreviated as follows.
 - DNX8170DABS: **DNX8**
 - DNX7170DABS: **DNX7**
- If above icon is showed, read the article applicable to the unit you use.

Number	Name	Motion
1	Remote Sensor	• Receives the remote control signal.
2	▼ ▲ (Volume)	• Adjusts volume. The volume will go up until 15 when you keep pressing ▲.
3	NAV	• Displays the navigation screen.
4	HOME	• Displays the HOME screen (P.14). • Pressing for 1 second turns the power off. * • When the power off turns the power on. * The function of the button when held varies depending on the "Manual Power OFF" setting. (P.65)
5	MENU	• Displays the popup menu screen. • Pressing for 1 second turns the screen off.
6		• Displays the APP (CarPlay/ Android Auto) screen. • Pressing for 1 second displays the Voice Recognition screen (P.55).
7	▲	• Displays the Angle Adjust screen. – DISC EJECT : Ejects the disc. – OPEN : Fully opens the panel to the location of the SD card slot. • When the panel is opened, pressing closes the panel. • To forcibly eject the disc, press it for 2 seconds and touch DISC EJECT after the message is displayed.

Basic Operations

Number	Name	Motion
8	Disc insert slot	• A slot to insert a disc media.
9	SD card slot	<ul style="list-style-type: none"> • A slot to insert an SD card. • You can play audio/visual file in the card. * • An SD card slot for upgrading the map. For how to upgrade the map, refer to the instruction manual of the navigation system. * If the map update file remains in the SD card, you cannot play audio/visual file.
10	SI	• This indicator flashes when the vehicle ignition is off (P.11). (Only for DNX8)

DNX5170DABS/ DNX5170BTS/ DNX317DABS/ DNX317BTS

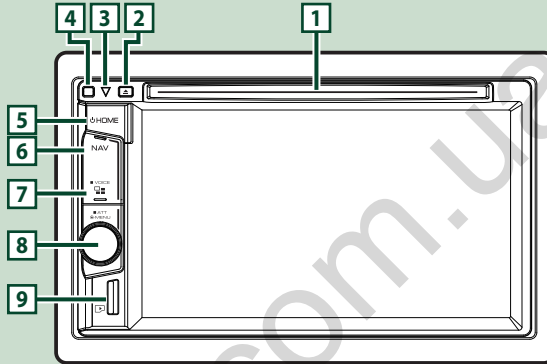

NOTE

- The panels shown in this guide are examples used to provide clear explanations of the operations. For this reason, they may be different from the actual panels.
 - In this manual, each model name is abbreviated as follows.
 - DNX5170DABS/ DNX5170BTS: **DNX5**
 - DNX317DABS/ DNX317BTS: **DNX3**
- If above icon is showed, read the article applicable to the unit you use.

Number	Name	Motion
1	Disc insert slot	• A slot to insert a disc media.
2	▲	<ul style="list-style-type: none"> • Ejects the disc. • To forcibly eject the disc, press it for 2 seconds and touch Yes after the message is displayed.
3	SI	• This indicator flashes when the vehicle ignition is off (P.11).
4	Remote Sensor	• Receives the remote control signal.
5	HOME	<ul style="list-style-type: none"> • Displays the HOME screen (P.14). • Pressing for 1 second turns the power off. * • When the power off turns the power on. * The function of the button when held varies depending on the "Manual Power OFF" setting. (P.65)

Number	Name	Motion
6	NAV	<ul style="list-style-type: none"> Displays the navigation screen.
7		<ul style="list-style-type: none"> Displays the APP (CarPlay) screen. Pressing for 1 second displays the Voice Recognition screen (P.55).
8	Volume Knob	<ul style="list-style-type: none"> Turn to adjust the volume. Press to display the pop-up menu. Pressing for 1 second switches attenuation of the volume on/off.
9	microSD card slot	<ul style="list-style-type: none"> A slot to insert a microSD card. You can play audio/visual file in the card. * (Only for DNX5) An SD card slot for upgrading the map. For how to upgrade the map, refer to the instruction manual of the navigation system. <p>* If the map update file remains in the SD card, you cannot play audio/visual file.</p>

Turning on the Unit

The method of turning on is different depending on the model.

1 Press the **HOME** button.

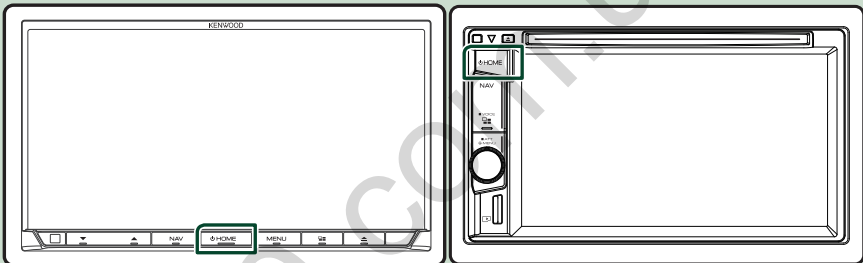

► The unit is turned on.

● To turn off the unit:

1 Press the **HOME** button for 1 second.

NOTE

- If it is your first time turning the unit on after installation, it will be necessary to perform Initial setup (P.10).
- The function of the button when held varies depending on the "Manual Power OFF" setting. (P.65)

Initial Settings

Initial setup

Perform this setup when you use this unit first time.

1 Set each item as follows.

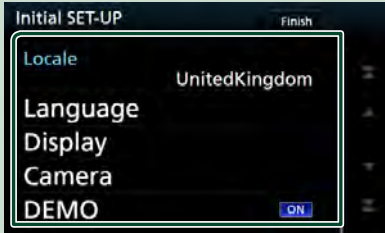

■ Locale

Select the country for the navigation system. The language, the distance unit, and the gasoline unit are set.

- 1 Touch **Locale**.
- 2 Select the desired country.

■ Language



Select the language used for the control screen and setting items. Default is "British English (en)".

- 1 Touch **Language**.
- 2 Touch **Language Select**.
- 3 Select the desired language.
- 4 Touch .

For detailed operation, see **User Interface Setup (P.63)**.

■ Display

Set the button illumination color. If it is hard to see the image on the screen even after adjusting the front panel angle, adjust the viewing angle.

- 1 Touch **Display**.
- 2 Touch **Key Color**.
- 3 Select the desired color.
- 4 Touch .
- 5 Touch **Viewing Angle**.
- 6 Select a viewing angle
- 7 Touch .

For detailed operation, see **Display Setup (P.66)**.

■ Camera

Set the parameters for the camera.

- 1 Touch **Camera**.
- 2 Set each item and touch .

For detailed operation, see **Camera Setup (P.59)**.

■ DEMO

Set the demonstration mode. Default is "OFF".

- 1 Touch **DEMO** and set ON or OFF.

2 Touch Finish.



NOTE

- These settings can be set from the SETUP menu. See **Setting Up (P.62)**.

Security Code Setup

You can set up a security code to protect your receiver system against theft.

When the Security Code function is activated, the code cannot be changed and the function cannot be released. Note the Security Code can be set as the 4 digit number of your choice.

- 1 **DNX8** **DNX7**
Press the **MENU** button.
DNX5 **DNX3**
Press the volume knob.
➤ Popup menu appears.

- 2 Touch **SETUP**.



➤ SETUP Menu screen appears.

- 3 Touch **Security**.



➤ Security screen appears.

- 4 Touch **Security Code Set** on the Security screen.

➤ Security Code Set screen appears.

- 5 Enter a security code with four-digit number and touch **Enter**.

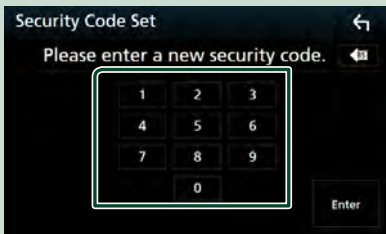

- 6 Enter the same code again and touch **Enter**.

Now, your security code is registered.

NOTE

- Touch **BS** to delete the last entry.
- If you enter a different security code, the screen returns to step 5 (for the first code entry).
- If you have disconnected the Receiver from battery, enter the correct security code as that you have entered in step 5 and touch **Enter**. You can use your receiver.

To change the security code:

- 1 Touch **Security Code Change** on the Security screen, then repeat step 5 and 6.

To clear the security code:

- 1 Touch **Security Code Cancellation** on the Security screen.

To activate the security function (**DNX8** **DNX5** **DNX3**)

- 1 Touch **SI** on the Security screen.

Each time you touch **SI**, the function is activated (**ON**) or deactivated (**OFF**).

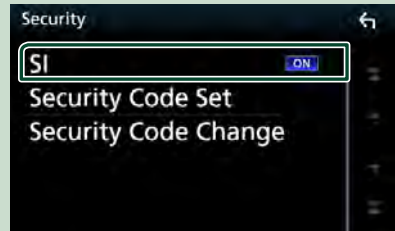

The security indicator on the monitor panel flashes when the vehicle ignition is off.

Calendar/clock settings

- 1 Press the **MENU** button.
➤ Popup menu appears.

- 2 Touch **SETUP**.



➤ SETUP Menu screen appears.

- 3 Touch **User Interface**.



➤ User Interface screen appears.

- 4 Set each item as follows.
Scroll the page to show the item.



■ Clock

NAV-SYNC (Default): Synchronizes the clock time with navigation.

Manual: Sets the clock manually.

■ Time Zone

If you have selected **Manual** for Clock, select the time zone.

■ Clock Adjust

If you select **Manual** for Clock, adjust the date and time manually. (P.64)

Adjusting the volume

To adjust the volume (0 to 40),

DNX8 **DNX7**

Press ▲ to increase, and press ▼ to decrease.

Holding ▲ increases the volume continuously to level 15.



DNX5 **DNX3**

Turn to the right to increase, and turn to the left to decrease.



Monitor Angle Control

(**DNX8** **DNX7**)

You can adjust the position of the monitor.

- 1 Press the ▲ button.

➤ Angle Adjust screen appears.

- 2 Select a below number that represents your desired angle setting.

Default is "0".



■ Off Position

You can store the current monitor angle as the angle during power off. Touch **Memory** when the desired angle is selected.

■ Auto Open (**DNX8**)

The front panel can be set to open automatically when the ignition is turned off, so that it can be detached for antitheft purpose.

Detaching The Front Panel (DNX8)

You can detach the front panel to prevent theft.

- 1 Press the **Q** button.
- 2 Touch **OPEN** to the panel fully opens.

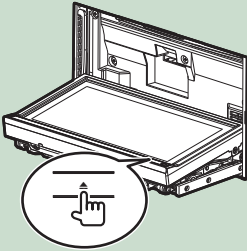

NOTE

- You can set the front panel to open automatically when the ignition is turned off. See **Monitor Angle Control (P.12)**.

- 2 Detach the panel as the diagrams below.

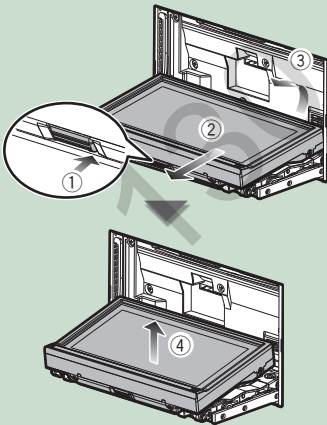

NOTE

- The attaching plate closes automatically in about 10 seconds after the front panel is released. Remove the panel before this happens.

● Attaching the front panel:

Hold the panel securely so as not to drop it accidentally, and fit it onto the attaching plate until it is firmly locked.

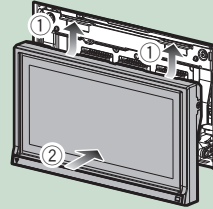

Touch screen operations

To perform operations on the screen, you need to touch, touch and hold, flick or swipe to select an item, display setting menu screen or to change the page, etc.

● Touch

Touch the screen gently to select an item on the screen.

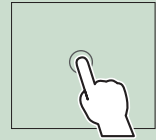

● Touch and hold

Touch the screen and keep your finger in place until the display changes or a message is displayed.

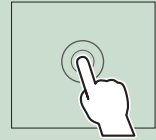

● Flick

Slide your finger quickly to the left or right on the screen to change the page. You can scroll the list screen by flicking the screen up/down.



● Swipe

Slide your finger up or down on the screen to scroll the screen.



HOME screen descriptions

Most functions can be performed from the HOME screen.

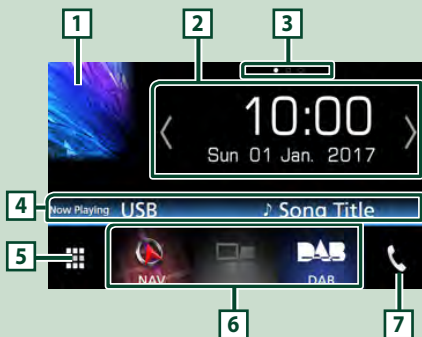

- | | |
|---|--|
| 1 | • Displays the control screen of current source. |
| 2 | • Widget
– You can change the widget by touching / or flicking left or right on the widget area.
– Touch the widget to display the detailed screen. |
| 3 | • Page indication for widgets |
| 4 | • Current source information |
| 5 | • Displays the source selection screen. (P.14) |
| 6 | • Short-cut playback source icons (P.15) |
| 7 | • Displays the Hands Free screen. (P.54)
• When connecting as Apple CarPlay or Android Auto, it works as a phone provided in Apple CarPlay or Android Auto. |

Display the HOME

- 1 Press the HOME button.



➤ HOME screen appears.

Source selection screen descriptions

You can display all playback sources and options on the source selection screen.

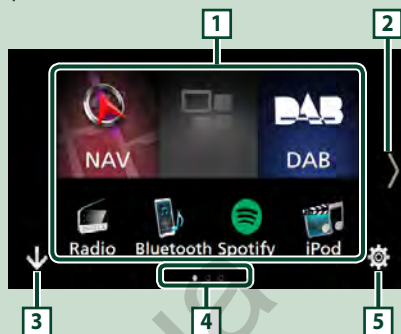











- | | |
|---|---|
| 1 | • Changes the playback source.
For playback sources, see P.14. |
| 2 | • Changes the page. (Touch / .)
You can also change the page by flicking left or right on the screen. |
| 3 | • Returns to previous screen. |
| 4 | • Page indication |
| 5 | • Displays the SETUP Menu screen. (P.63) |

Select the playback source

- 1 Touch on the HOME screen.

From the screen, you can select the following sources and functions.

- | | |
|------|--|
| | • Displays the navigation screen. (P.18) |
|
 | • Switches to the Android Auto*/ Apple Car Play screen from the connected iPod touch/iPhone/Android device.*1 (P.34) |
| | • Switches to the Radio broadcast. (P.40) |
| | • Switches to the DAB broadcast. (P.43) |
| | • Plays a Bluetooth audio player. (P.48) |

	• Plays a disc. (P.22)
	• Plays an iPod/iPhone. (P.31)
	• Plays files on a USB device. (P.28)
	• Plays files on an SD card. *2 (P.28)
	• Switches to the Spotify. (P.38)
	• Plays a device connected to the HDMI/ MHL input terminal. (P.61)
	• Switches to an external component connected to the AV-IN input terminal. (P.61)
	• Switches to the Mirroring screen from the connected Android device. (P.34)
	• Displays the Audio screen. (P.68)
	• Puts the unit in standby. (P.16)

*1 When iPhone compatible with CarPlay is connected, **Apple CarPlay** is displayed. When an Android device compatible with Android Auto is connected, **Android Auto** is displayed.

*2 Only for **DNX8 DNX7 DNX5**.

To select the playback source on the HOME screen





The 3 items displayed on the source selection screen as the large icons are shown on the HOME screen.

You can change items displayed on this area by customizing the source selection screen. **(P.16)**

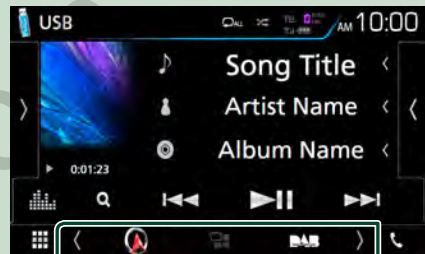
To select the playback source on the source control screen



Display source selection buttons by touching  or  or flicking left or right on the source control screen, then select a playback source.

Put the unit in standby

- 1 Touch  on the HOME screen.
- 2 Touch **STANDBY**.

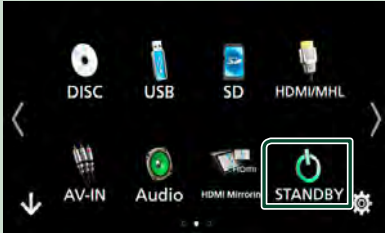

Customize Short-cut buttons on HOME screen

You can arrange the position of the source icons as you like.

- 1 Touch  on the HOME screen.
- 2 Touch and hold the icon which you want to move to go into the customizing mode.
- 3 Drag it where you want to move.



Source control screen descriptions

There are some functions which can be operated from most screens.

Indicators

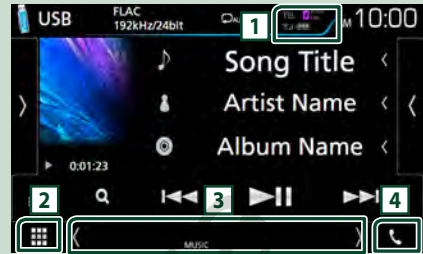

Navigation information

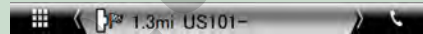

Short-cut buttons

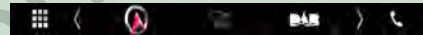



Connected Bluetooth device information.

-  : Lights up when quick charging battery of the connected iPod/ iPhone/ Smartphone.

All sources icon

Displays all sources.

3 Secondary screen

-   : The Secondary screen changes every time you touch it. You can also change the Secondary screen by flicking left or right on the screen.
- Indicators: Displays the current source condition and so on.
 - **ATT**: The attenuator is active.
 - **DUAL**: The dual zone function is on.
 - **MUTE**: The mute function is active.
 - **LOUD**: The loudness control function is on.
- Navigation information: Displays the current location and the direction. The screen changes to the navigation screen when you touch here.
- Short-cut buttons: The source changes to the one you have set as a short-cut. For the short-cut setting, refer to **Customize Short-cut buttons on HOME screen (P.16)**.

4

Touch to display the Hands Free screen. **(P.54)**
 When connecting as Apple CarPlay or Android Auto, it works as a phone provided in Apple CarPlay or Android Auto.

Popup menu

1 Press the **MENU** button.











➤ Popup menu appears.

2 Touch to display the popup menu.



The contents of the menu are as follows.

	• Displays the Screen Adjustment screen. (P.62)
	• Turns the display off. (P.17)
	• Displays the view camera. (P.59)
	• Displays the SETUP Menu screen. (P.63)
	• Displays the Audio Control Menu screen. (P.68)
	• Displays the control screen of current source. Icon feature differs depending on the source.
	• Close the popup menu.
	• See HOME screen descriptions (P.14) .
	

Turn off the screen

1 Select **Display OFF** on the pop-up menu.



List screen

There are some common function keys in the list screens of most sources.

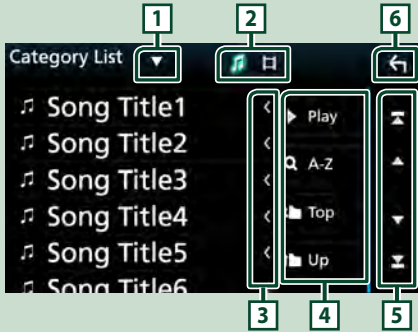

- 1** Displays list type selection window.
- 2** Displays music/movie file list.
- 3** **Text scroll**
Scrolls the displayed text.
- 4** **etc.**
Keys with various functions are displayed here.
 - **Play**: Plays all tracks in the folder containing the current track.
 - **A-Z**: Jump to the letter entered (alphabet search).
 - **Top** **Up**: Moves to the upper hierarchy.
- 5** **Page scroll**
You can change the page to display more items by pressing .
 • : Displays the top or bottom page.
- 6** **Return**
Returns to previous screen.

NOTE

- Buttons which cannot be activated from the list screen are not displayed.

Navigation Operation

For details on the navigation function, please refer to the Navigation Instruction Manual.

Display the navigation screen

- 1** Press the **NAV** button.



> The navigation screen appears.

How to Use the Navigation System

- 1** Operate the desired function from the Main Menu screen.

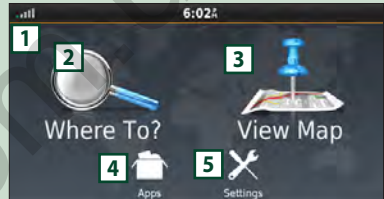

- 1** GPS satellite strength.
- 2** Finds a destination.
- 3** Views the map.
- 4** Uses the Apps such as ecoRoute and Help.
- 5** Adjusts the settings.

NOTE

- You can get additional information about using the navigation system from Help. To display Help, touch **Apps** and then touch **Help**.

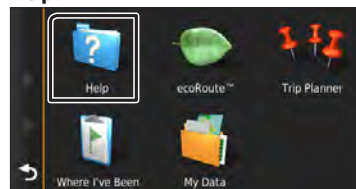

NOTE

- For more information about your navigation system, download the latest version of the Owner's Manual from <http://manual.kenwood.com/edition/im392/>

2 Enter your destination and start the guidance.

Finding points of interest

- ① Touch **Where To?**
- ② Select a category and a subcategory.
- ③ Select a destination.
- ④ Touch **Go!**

NOTE

- To enter letters contained in the name, touch the Search bar and enter the letters.

3 Follow your route to the destination.

NOTE

- The speed limit icon feature is for information only and does not replace the driver's responsibility to abide by all posted speed limit signs and to use safe driving judgment at all times. Garmin and JVC KENWOOD will not be responsible for any traffic fines or citations that you may receive for failing to follow all applicable traffic laws and signs.

Your route is marked with a magenta line. As you travel, your navigation system guides you to your destination with voice prompts, arrows on the map, and directions at the top of the map. If you depart from the original route, your navigation system recalculates the route.



- | | |
|---|---|
| 1 | Views the Next Turn page or the junction view page, when available. |
| 2 | Views the Turn List page. |
| 3 | Views the Where Am I? page. |
| 4 | Stops the current route. |
| 5 | Displays traffic information on the route. |
| 6 | Returns to the Main menu. |
| 7 | Displays a different data field. |
| 8 | Views the Trip Computer. |
| 9 | Displays more options. |



NOTE

- Touch and drag the map to view a different area of the map.
- A speed limit icon could appear as you travel on major roadways.



● Adding a stop

- ① While navigating a route, touch  and then touch **Where To?**
- ② Search for the extra stop.
- ③ Touch **Go!**
- ④ Touch **Add to Active Route** to add this stop before your final destination.

● Taking a detour

- ① While navigating a route, touch .
- ② Touch .

■ Manually avoiding traffic on your route

- ① From the map, touch .
- ② Touch **Traffic On Route**.
- ③ If necessary, touch the arrows to view other traffic delays on your route.
- ④ Touch  > **Avoid**.

■ Viewing the traffic map

- ① The traffic map shows color-coded traffic flow and delays on nearby.

Basic Operations

■ About traffic

- Traffic service is not available in some areas or countries.
- Garmin and JVC KENWOOD are not responsible for the accuracy or timeliness of the traffic information.
- You can receive INRIX traffic information and weather forecast by connecting your iPhone or Android smartphone in which the "KENWOOD Traffic Powered By INRIX" application is installed.

For details, see "KENWOOD Traffic Powered By INRIX" application.

■ Updating maps

You can purchase updated map data from Garmin.



- ① Go to www.garmin.com/kenwood.
- ② Select Update.
- ③ Follow the on-screen instructions.

Control audio from the navigation screen

You can control audio sources while the navigation screen is displayed.

Also, you can view the navigation information while the source control screen is displayed.

(P.16)

- 1 While playing the audio, touch  /  in the navigation screen.



Each time you touch the icon, the screen switches as follows.

Displays the navigation and control keys of the current source.



Displays the navigation and current video playback display.

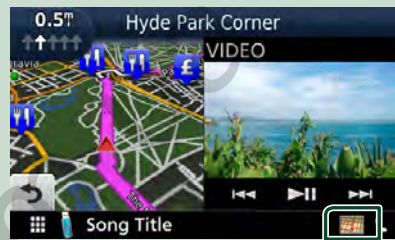

NOTE

- The screen switches between playback screen and view camera each time the viewing area is touched.

Returns to the full navigation screen.

NOTE

- For details on control keys, refer to the instructions in each section.
- : It does not appear if the control keys like AV-IN, etc. are not exist.
- Touching the source icon in the bottom of the screen displays the full audio screen.

Navigation Setup

1 Press the **MENU** button.

- Popup menu appears.

2 Touch **SETUP**.

- SETUP Menu screen appears.

3 Touch **Navigation**.



- Navigation SETUP screen appears.

4 Set each item as follows.



■ NAV Mute

Mutes the volume of rear speakers during voice guidance of the navigation system. Default is "ON".

■ NAV Interrupt Speaker

Selects speakers used for voice guidance of the navigation system.

- **Front L:** Uses the front left side speaker for voice guidance.
- **Front R:** Uses the front right side speaker for voice guidance.
- **Front All (Default):** Uses both front speakers for voice guidance.

■ NAV Voice Volume

Adjusts the volume for voice guidance of the navigation system. Default is "24".

KENWOOD Traffic Powered By INRIX

You can receive INRIX traffic information and weather forecast by connecting your iPhone or Android smartphone in which the "KENWOOD Traffic Powered By INRIX" application is installed to this unit.

Preparation

- Install the latest version of the KENWOOD Traffic Powered By INRIX application on your iPhone or Android.
 - iPhone: Search for "KENWOOD Traffic Powered By INRIX" in the Apple App Store to find and install the most current version.
 - Android: Search for "KENWOOD Traffic Powered By INRIX" in Google play to find and install the most current version.
- For details, see "KENWOOD Traffic Powered By INRIX" application.

1 Register the Smartphone.

To connect a smartphone via Bluetooth, register it as the Bluetooth device and do the App (SPP) profile setting of the connection beforehand. See **Register from the Bluetooth unit (P.49)** and **Connect the Bluetooth unit (P.50)**.

2 Press the **NAV** button.



- Navigation screen appears.

Touch **Apps** on the Main Menu screen and then an icon of your desired content
For details, see Navigation system manual.

Disc

Playing a disc

Insert a disc

DNX8 **DNX7**

- 1 Press the **▲** button.



- 2 Touch **DISC EJECT**.

▶ The panel opens.

- 3 Insert the disc into the slot.

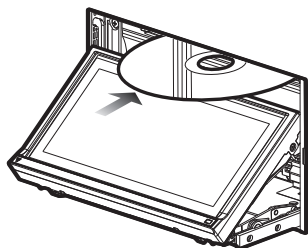

▶ The panel closes automatically.
The unit loads the disc and playback starts.

DNX5 **DNX3**

- 1 Insert the disc into the slot.

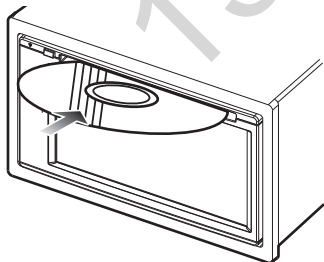

▶ The unit loads the disc and playback starts.

Eject a disc

DNX8 **DNX7**

- 1 Press the **▲** button.

- 2 Touch **DISC EJECT**.

When removing a disc, pull it horizontally.

- 3 Press the **▲** button.

DNX5 **DNX3**

- 1 Press the **▲** button.

DVD/VCD Basic Operation

Most functions can be controlled from the source control screen and playback screen.

NOTE

- The screen shot below is for DVD. It may be different from the one for VCD.

- 1 When the operation buttons are not displayed on the screen, touch the **7** area.

Control screen

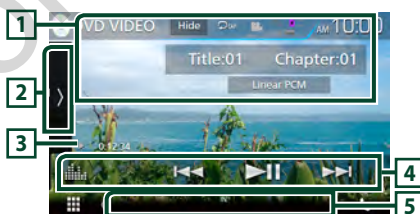







Video screen



1 Information display

Displays the following information.











- **Title #, Chapter #:** DVD title and chapter number display
- **Track #/Scene #:** VCD track or scene number display. Scene # is displayed only when Playback control (PBC) is on.
- **Linear PCM, etc.:** Audio format

- **Hide** : Hides the control screen.
-  : Repeats the current content. Each time you touch the key, repeat mode switches in the following sequence;
DVD: Title repeat (), Chapter repeat (), Repeat off ()
VCD (PBC On): Does not repeat
VCD (PBC Off): Track repeat (), Repeat off ()



2 Function panel

Touch on the left side of the screen to display the function panel. Touch again to close the panel. For details on the keys, see **Function panel (P.23)**.

3 Play mode indicator/ Playing time

-  ,  ,  , etc.: Current play mode indicator
 The meanings of each icon are as follows;  (play),  (fast forward),  (fast backward),  (stop),  (resume stop),  (pause),  (slow playback),  (slow reverse playback).

4 Function bar

-  : Searches the previous/next content.
 Touch and hold to fast forward or fast backward. (It will be cancelled automatically after about 50 seconds.)
-  : Plays or pauses.
-  : Displays the Graphic Equalizer screen. (P.71)

5 Indicator Items

- **IN**: A disc is inserted.
 White: A Disc is inside the unit.
 Orange: Error at the disc player

VCD

- **1chLL/2chLL**: Identifies the left audio output of channel 1 or 2.
- **1chLR/2chLR**: Identifies the monaural audio output of channel 1 or 2.
- **1chRR/2chRR**: Identifies the right audio output of channel 1 or 2.
- **1chST/2chST**: Identifies the stereo audio output of channel 1 or 2.
- **LL**: Identifies the left audio output.
- **LR**: Identifies the monaural audio output.
- **RR**: Identifies the right audio output.
- **ST**: Identifies the stereo audio output.
- **PBC**: The PBC function is on.
- **VER1**: The VCD version is 1.

- **VER2**: The VCD version is 2.

6 Searching area

Touch to search the next/previous content.

7 Key display area

Touch to display the control screen.

8 MENU CTRL (DVD only)

Touch to display the DVD-VIDEO disc menu control screen. See **DVD Disc Menu Operation (P.25)**.

NOTE

- The control screen disappears when no operation is done for 5 seconds.

Function panel

1 Touch on the left side of the screen.



The functions of each key are as follows.



Stops playback. When touched twice, the disc is played from the beginning when you play it the next time.



Fast forward or fast backward. Each time you touch the key, the speed changes; 2 times, 8 times.

or (DVD only)

Plays in slow motion forward or backward.

SETUP (DVD only)

Touch to display the DVD SETUP screen. See **DVD Setup (P.26)**.

MENU CTRL (DVD only)

Touch to display the DVD-VIDEO disc menu control screen. See **DVD Disc Menu Operation (P.25)**.

PBC (VCD only)

Turn Playback control (PBC) on or off.

Audio (VCD only)

Change the audio output channel.

Music CD/ Disc media Basic Operation

Most functions can be controlled from the source control screen and playback screen.

NOTE

- In this manual, "Music CD" will be referred to as the general CDs which include music tracks in. "Disc media" will be referred to as CD/DVD disc which includes audio or video files.
- The screen shot below is for disc media. It may be different from the one for CD.

Control screen

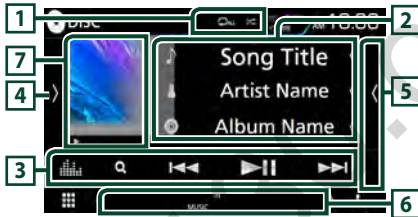

Content list panel



1 [Repeat] / [Repeat All]

- [Repeat] : Repeats the current track/folder. Each time you touch the key, repeat mode switches in the following sequence; Track/ File repeat ([Repeat]), Folder repeat ([Repeat All]) (Disc media only), Repeat all ([Repeat All])

- [Repeat All] : Randomly plays all tracks in current folder/disc. Each time you touch the key, random mode switches in the following sequence; Track random ([Repeat All]) (Music CD only), Folder random ([Repeat All]) (Disc media only), Random off ([Repeat All])

2 Track information

Displays the information of the current track/ file. Only a file name and a folder name are displayed if there is no tag information. (Disc media only)

3 Function bar

- [Search] (Disc media only) : Searches file. For details on search operation, see **File search (P.25)**.
- [Previous/Next] : Searches the previous/next content. Touch and hold to fast forward or fast backward. (It will be cancelled automatically after about 50 seconds.)
- [Play/Pause] : Plays or pauses.
- [Equalizer] : Displays the Graphic Equalizer screen. (P.71)

4 Function panel (Disc media only)

Touch on the left side of the screen to display the function panel. Touch again to close the panel.

- [Previous/Next Folder] : Searches previous/next folder.

5 Content list

Touch on the right side of the screen to display the Content list. Touch again to close the list.

6 Indicator Items

- **IN**: A disc is inserted.
White: A Disc is inside the unit.
Orange: Error at the disc player
- **VIDEO**: Identifies the video file.
- **MUSIC**: Identifies the music file.

7 Artwork (Disc media only) /Play mode indicator/ Playing time

The jacket of the currently playing file is displayed.

- ▶, ▶▶, etc.: Current play mode indicator
- The meanings of each icon are as follows; ▶ (play), ▶▶ (fast forward), ◀◀ (fast backward), || (pause).

8 Content list panel

Displays the playing list. When you touch a track/ file name on the list, playback will start.

Video screen



9 Searching file area (Video file only)

Touch to search the next/previous file.

10 Key display area (Video file only)

Touch to display the control screen.

Search Operation (Disc media only)

You can search music or video files by the following operations.

NOTE

- For operations in the list screen, see **List screen (P.18)**.

File search

You can search a file according to hierarchy.

1 Touch Q.

- Folder List screen appears.

2 Touch the desired folder.

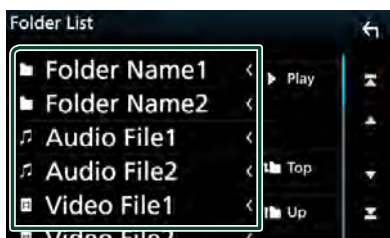

- When you touch a folder its contents are displayed.

3 Touch desired item from the content list.

- Playback starts.

DVD Disc Menu Operation

You can set up some items in the DVD-VIDEO disc menu.

1 Touch illustrated area during playback.



- Menu Control screen appears.

2 Perform desired operation as follows.



■ Displays the top menu

Touch **TOP**.*

■ Displays the menu

Touch **MENU**.*

■ Displays the previous menu

Touch **Return**.*

■ Enters selected item

Touch **Enter**.

■ Enables direct operation

Touch **Highlight** to enter the highlight control mode (P.26).

■ Moves the cursor

Touch **▲**, **▼**, **◀**, **▶**.

■ **Switches the subtitle language**

Touch **Subtitle**. Each time you touch this key, language is switched.

■ **Switches the audio language**

Touch **Audio**. Each time you touch this key, language is switched.

■ **Switches the picture angle**

Touch **Angle**. Each time you touch this key, picture angle is switched.

* These keys may not function depending on the disc.

■ **Highlight control**

Highlight control lets you control the DVD menu by touching the menu key directly on the screen.

1 Touch **Highlight** in the Menu Control screen.

2 Touch desired item on the screen.



NOTE

- The highlight control is cleared automatically if you do not operate for a constant time.

DVD Setup

You can set up the DVD playback functions.

1 Touch illustrated area during playback.



2 Touch on the left side of the screen.

Touch **SETUP**.



> DVD SETUP screen appears.

3 Set each item as follows.



■ **Menu Language / Subtitle Language / Audio Language**

See **Language setup (P.27)**.

■ **Dynamic Range Control**

Sets the dynamic range.

Wide: The dynamic range is wide.

Normal: The dynamic range is normal.

Dialog (Default): Makes the total sound volume larger than other modes. This is effective only when you are using Dolby Digital software.

■ Screen Ratio

Sets the screen display mode.

16:9 (Default): Displays wide pictures.

4:3 LB: Displays wide pictures in the Letter Box format (having black stripes at the top and bottom of screen).

4:3 PS: Displays wide pictures in the Pan & Scan format (showing pictures cut at the right and left ends).

■ Language setup

This setting is for the language used in the menu, subtitle, and voice.

1 Touch the desired item; **Menu Language**, **Subtitle Language**, **Audio Language**.

➤ Language Set screen appears.

2 Select a language.



For language code, refer to **DVD Language Codes (P.89)**.

Sets the entered language and returns to the DVD Setting screen.

NOTE

- To set the DVD's original language for audio language, touch **Original**.

USB/SD card

Connecting a USB device

1 Connect the USB device with the USB cable. (P.82)

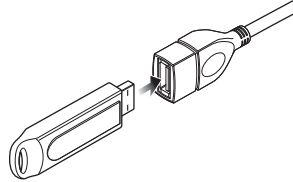

2 Press the **HOME** button.

3 Touch .

4 Touch **USB**. (P.14)

■ Disconnect the USB device

1 Press the **HOME** button.

2 Touch a source other than **USB**.

3 Detach the USB device.

■ Usable USB device

You can use a mass-storage-class USB device on this unit.

The word "USB device" appearing in this manual indicates a flash memory device.

● About file system

The file system should be the one of the following.

- FAT16
- FAT32
- exFAT
- NTFS

NOTE

- Install the USB device in the place where it will not affect safe driving.
- You cannot connect a USB device via a USB hub and Multi Card Reader.
- Take backups of the audio files used with this unit. The files can be erased depending on the operating conditions of the USB device. We shall have no compensation for any damage arising from any erased data.

Inserting the SD card

DNX8 DNX7

- 1 Press the **▲** button.



- 2 Touch **OPEN** to the panel fully opens.
- 3 Insert the SD card into the slot until it clicks.

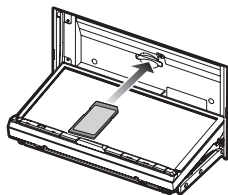

- 4 Press the **▲** button.
- 5 Press the **HOME** button.
- 6 Touch **☐**.
- 7 Touch **SD**. (P.14)

DNX5

- 1 Insert the microSD card into the slot until it clicks.

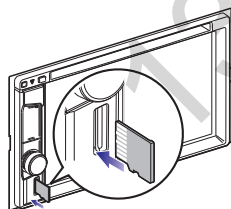

- 2 Press the **HOME** button.
- 3 Touch **☐**.
- 4 Touch **SD**. (P.14)

NOTE

- A dummy microSD card is inserted as the slot cover. Remove it before using and keep it in an appropriate place.

Remove the SD card

DNX8 DNX7

- 1 Press the **▲** button.
- 2 Touch **OPEN** to the panel fully opens.
- 3 Push the SD card until it clicks and then remove your finger from the card. The card pops up so that you can pull it out with your fingers.
- 4 Press the **▲** button.

DNX5

- 1 Push the microSD card until it clicks and then remove your finger from the card. The card pops up so that you can pull it out with your fingers.

Usable SD card.

The unit is capable of playback of SD/SDHC/SDXC memory cards complying with the SD, SDHC or SDXC standard. A special adapter is required to use a miniSD card, miniSDHC card, microSD card, microSDHC, or microSDXC card. The MultiMedia Card (MMC) cannot be used.

USB/SD card Basic Operation

Most functions can be controlled from the source control screen and playback screen.

Control screen

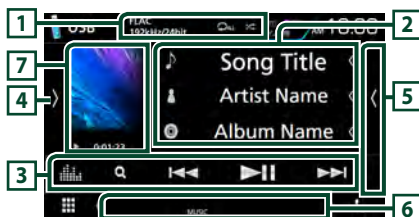

Content list panel

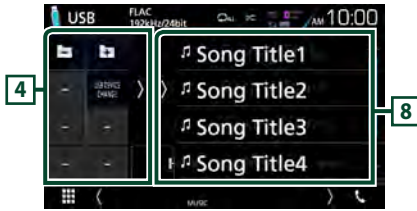

1 Repeat / Shuffle

- / : Repeats the current track/folder. Each time you touch the key, repeat mode switches in the following sequence; File repeat (), Folder repeat (), Repeat all ()
- : Randomly plays all tracks in current folder. Each time you touch the key, random mode switches in the following sequence; File random (), Random off ()
- When a high-resolution source is played, its format information is displayed.

2 Track information

Displays the information of the current file.
Only a file name and a folder name are displayed if there is no tag information.

3 Function bar

- : Searches track/file. For details on search operation, see **Search Operation (P.30)**.
- : Searches the previous/next track/file.
Touch and hold to fast forward or fast backward. (It will be cancelled automatically after about 50 seconds.)
- : Plays or pauses.
- : Displays the Graphic Equalizer screen. (P.71)

4 Function panel

Touch on the left side of the screen to display the function panel. Touch again to close the panel.

- : Searches previous/next folder.
- **USB DEVICE CHANGE**
(Only for USB device of **DNX8** **DNX7** **DNX5**): Switches to another USB device when two USB devices are connected.

5 Content list

Touch on the right side of the screen to display the Content list. Touch again to close the list.

6 Indicator Items

- **VIDEO**: Identifies the video file.
- **MUSIC**: Identifies the music file.

7 Artwork/ Play mode indicator/ Playing time

The jacket of the currently playing file is displayed.

- : etc.: Current play mode indicator
The meanings of each icon are as follows;
 (play), (fast forward), (fast backward), (pause).

8 Content list panel

Displays the playing list. When you touch a track/file name on the list, playback will start.

Video screen



9 Searching file area (Video file only)

Touch to search the next/previous file.

10 Key display area (Video file only)

Touch to display the control screen.

Search Operation

You can search music or video files by the following operations.

- 1 Touch **Q**.
- 2 Touch **▼**.



- 3 Select the list type.

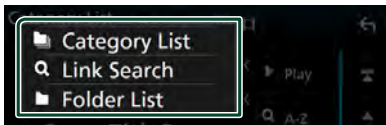

NOTE

- For operations in the list screen, see **List screen (P.18)**.

Category search

You can search a file by selecting category.

- 1 Touch **Category List**.
- 2 Select whether you search by audio files **🎵** or video files **📺**.
- 3 Touch the desired category.

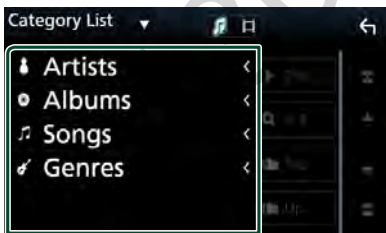

- The list corresponding to your selection appears.

- 4 Touch to select desired item in the list. Repeat this step until you find the desired file.

Link search

You can search a file of same artist/album/genre as the current track.

- 1 Touch **Link Search**.
- 2 Touch the desired tag type. You can select from artist, album and genre.

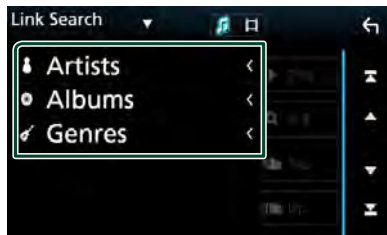

- The list corresponding to your selection appears.

- 3 Touch desired item from the content list.

Folder search

You can search a file according to hierarchy.

- 1 Touch **Folder List**.

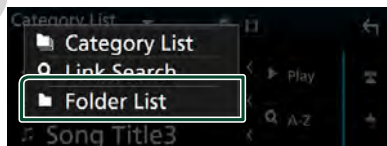

- 2 Touch the desired folder.

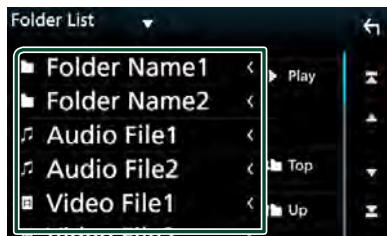

When you touch a folder its contents are displayed.

- 3 Touch to select desired item in the list. Repeat this step until you find the desired file.

iPod/iPhone

Preparation

Connectable iPod/iPhone

The following models can be connected to this unit.

Made for

- iPhone 6s Plus
- iPhone 6s
- iPhone 6 Plus
- iPhone 6
- iPhone 5s
- iPhone 5c
- iPhone 5
- iPod touch (6th generation)
- iPod touch (5th generation)

NOTE

- Latest compatible list of iPod/iPhone. For details, see www.kenwood.com/cs/ce/ipod/.
- By connecting your iPod/iPhone to this unit with an optional accessory iPod connection cable KCA-iP103, you can supply power to your iPod/iPhone as well as charge it while playing music. However, the power of this unit must be on.
- If you start playback after connecting the iPod, the music that has been played by the iPod is played first.

Connect iPod/iPhone

Wired connection

Preparation

- Connect an iPod/iPhone with the KCA-iP103 (optional accessory) while CarPlay is not connected.
- With a CarPlay-capable iPhone, turn off CarPlay by operating the iPhone at functional setup before connecting iPhone. For details of the setup method, contact the manufacturer of the terminal.
- **DNX8** **DNX7** **DNX5** : Plug the iPod/iPhone into the gray USB terminal with the KCA-iP103 (optional accessory).
- Only one iPod/iPhone can be connected.

1 Connect the iPod/iPhone using KCA-iP103. (P.83)

2 Press the HOME button.

3 Touch .

4 Touch iPod. (P.14)

● To disconnect the iPod/iPhone connected with the cable:

1 Detach the iPod/iPhone.

Bluetooth connection

Preparation

- To connect an iPhone via Bluetooth, register it as the Bluetooth device and do the profile setting of the connection beforehand. See **Register from the Bluetooth unit (P.49)** and **Connect the Bluetooth unit (P.50)**.
- Connect an iPhone on Bluetooth while CarPlay and an iPod/iPhone are not connected on USB.

Pair the iPhone through Bluetooth.

● Select the method of making connections for outputting sound from the iPod source.

1 Press the MENU button.

- Pop-up menu appears.

2 Touch SETUP.

- SETUP screen appears.

3 Touch AV .

➤ AV screen appears.

4 Touch iPod Bluetooth Connection .

Bluetooth (Default): Output sound using a Bluetooth device.

Bluetooth+HDMI: Output sound using an HDMI device and perform music selection, etc. using a Bluetooth device.

iPod/iPhone Basic Operation

Control screen

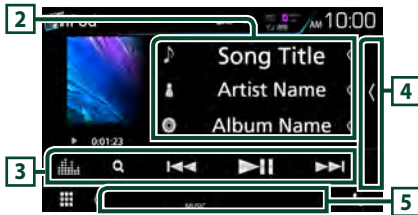

Content list panel

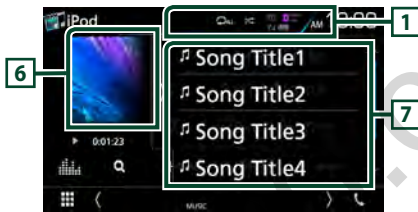

1 [Repeat / Shuffle]

- [Repeat] : Repeats the current track/album. Each time you touch the key, repeat mode switches in the following sequence; Song repeat ([Repeat]), All songs repeat ([Repeat All])
- [Shuffle] : Randomly plays all tracks in current album. Each time you touch the key, random mode switches in the following sequence; Song random ([Shuffle]), Album random ([Shuffle]), Random off ([Shuffle Off])

2 Track information

- Displays the information of the current file.
- Touch to display the category list screen. See **Category search (P.33)**.

3 Function bar

- [Search] : Searches track/file. For details on search operation, see **Search Operation (P.33)**.
- [Fast Forward/Backward] : Searches the previous/next track/file. Touch and hold to fast forward or fast backward. (It will be cancelled automatically after about 50 seconds.)
- [Play/Pause] : Plays or pauses.
- [Equalizer] : Displays the Graphic Equalizer screen. (P.71)

4 Content list

Touch on the right side of the screen to display the Content list. Touch again to close the list.

5 Indicator Items

- **MUSIC:** Identifies the music file.

6 Artwork/ Play mode indicator/ Playing time

The jacket of the currently playing file is displayed.

- [Play/Pause/Fast Forward], etc.: Current play mode indicator
- The meanings of each icon are as follows; [Play] (play), [Fast Forward] (fast forward), [Fast Backward] (fast backward), [Pause] (pause).

7 Content list panel

Displays the playing list. When you touch a track/file name on the list, playback will start.

Search Operation

You can search music files by the following operations.

1 Touch **Q**.

2 Touch **▼**.



3 Select the list type.

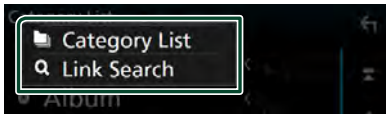

NOTE

- For operations in the list screen, see [List screen \(P.18\)](#).

Category search

You can search a file by selecting category.

1 Touch **Category List**.

2 Touch the desired category.

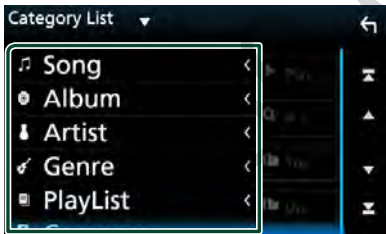

- The list corresponding to your selection appears.

3 Touch to select desired item in the list.
Repeat this step until you find the desired file.

Link search

You can search a file of same artist/album/genre/composer as the current track.

1 Touch **Link Search**.

2 Touch the desired tag type. You can select from artist, album, genre and composer.

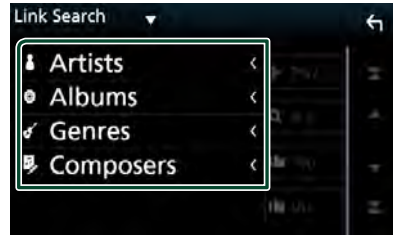

- The list corresponding to your selection appears.

3 Touch desired item from the content list.

APPS—Android Auto™/Apple CarPlay/Mirroring

Mirroring Operation

You can listen to music or watch video from the Mirroring operating on Android.

Preparation

Preparation

- Install the latest version of the KENWOOD Smartphone Control application on your Android. Search for “KENWOOD Smartphone Control” in Google play to find and install the most current version.
For details, see web site. http://www.kenwood.com/products/car_audio/app/kenwood_smartphone_control/eng/
- Screen calibration of Android device is required only when making the connection for the first time. Recalibration is only necessary when the output screen size of the Android device had been changed.
- To connect an Android device via Bluetooth, register it as the Bluetooth device and do the profile setting of the connection beforehand. See **Register from the Bluetooth unit (P.49)** and **Connect the Bluetooth unit (P.50)**.

- 1** The unit and the Android device are connected with MHL (KCA-MH100 ; sold separately) or HDMI (KCA-HD100 ; sold separately) and over Bluetooth profile HID and SPP. (P.83)

Operation

- 1** Press the **HOME** button.
- 2** Touch .
- 3** Touch **HDMI Mirroring** . (P.14)
- 4** Touch **Agree** .



1

HOME / BACK / TASK Key will be displayed on this unit screen, and can be moved within the screen by dragging. In addition, it is possible to minimize these keys when they are not required. HOME / BACK / TASK Key may not appear when using certain applications. (i.e. video application software etc.)

NOTE

- Smartphone control from this unit is limited to a single finger operation like Tap/ Double Tap/ Long Tap/ Swipe.
- Operation that requires two or more fingers such as Pinch-in/ Pinch-out/ Multi-tap are unavailable.

KENWOOD Music Control for Android

Preparation

- Install the latest version of the KENWOOD Music Control application on your Android. Search for “KENWOOD Music Control for Android” in Google play to find and install the most current version.
For details, see web site. http://www.kenwood.com/car/app/kmc1_aapp/eng/

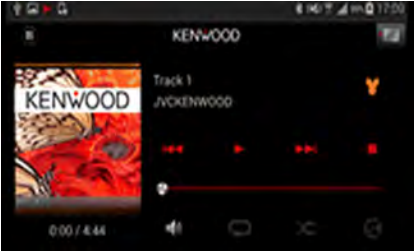

You can use KENWOOD Music Control as you use the smartphone to play music and video.

Apple CarPlay Operation

CarPlay is a smarter, safer way to use your iPhone in the car. CarPlay takes the things you want to do with iPhone while driving and displays them on the screen of the product. You can get directions, make calls, send and receive messages, and listen to the music from iPhone while driving. You can also use Siri voice control to make it easier to operate iPhone.

For details about CarPlay, visit <https://ssl.apple.com/ios/carplay/>.

Compatible iPhone devices

You can use CarPlay with the following iPhone models.

- iPhone 6s Plus
- iPhone 6s
- iPhone 6 Plus
- iPhone 6
- iPhone 5s
- iPhone 5c
- iPhone 5

Preparation

1 Connect iPhone using KCA-iP103 via USB (Black) terminal. (P.83)

When iPhone compatible with CarPlay is connected to the USB (Black) terminal, the Bluetooth smartphone currently connected is disconnected.

2 Unlock your iPhone.

Operation buttons and available Apps on the home screen of CarPlay

You can use the Apps of the connected iPhone. The items displayed and the language used on the screen differ among the connected devices.

To enter CarPlay mode, touch **Apple CarPlay** icon in the source selection screen. (P.14)

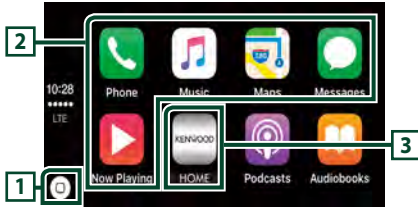

- Displays the home screen of CarPlay.
- Touch and hold to activates Siri.

2 Application buttons

Starts the application.

3 HOME

Exits the CarPlay screen and displays the Home screen.

To exit the CarPlay screen

- 1 Press the **HOME** button.

Use Siri

You can activate Siri.

- 1 Press the  button for 1 second.

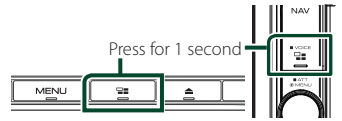

- 2 Talk to Siri.

To deactivate

- 1 Press the  button.

Switch to the Apple CarPlay screen while listening to another source

- 1 Press the  button.

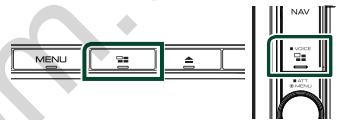

NOTE

- If sound is output using Apple CarPlay when the Apple CarPlay screen is displayed, the source is switched to Apple CarPlay.

Android Auto™ Operation (DNX8 DNX7)

Android Auto enables you to use functions of your Android device convenient for driving. You can easily access route guidance, make calls, listen to music, and access convenient functions on the Android device while driving. For details about Android Auto, visit <https://www.android.com/auto/> and <https://support.google.com/androidauto>.

Compatible Android devices

You can use Android Auto with Android devices of Android version 5.0 (Lollipop) or later.

NOTE

- Android Auto may not be available on all devices and is not available in all countries or regions.

Preparation

- 1 **Connect an Android device via USB terminal. (P.83)**
To use the hands-free function, connect the Android device via Bluetooth.
When an Android device compatible with Android Auto is connected to the USB terminal, the device is connected via Bluetooth automatically, and the Bluetooth smartphone currently connected is disconnected.
- 2 **Unlock your Android device.**

Operation buttons and available Apps on the Android Auto screen

You can perform the operations of the Apps of the connected Android device.
The items displayed on the screen differ among the connected Android devices.
To enter Android Auto mode, touch **Android Auto** icon in the source selection screen. (P.14)

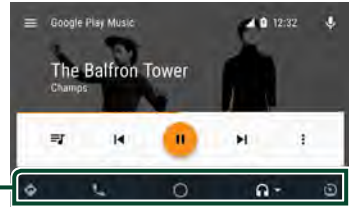

1 Application/information buttons

Starts the application or displays information.

To exit the Android Auto screen

- 1 Press the **HOME** button.

Using voice control

- 1 Press the  button for 1 second.



To cancel

- 1 Press the  button.

Switch to the Android Auto screen while listening to another source

- 1 Press the  button.



NOTE

- If sound is output using Android Auto when the Android Auto screen is displayed, the source is switched to Android Auto.

Spotify Operation

You can listen to the Spotify on this unit by controlling the application installed in the iPhone or Android.

To enter Spotify source, touch **Spotify** icon in the source selection screen. (P.14)

Preparation

- Install the latest version of the Spotify application "Spotify" on your iPhone or Android.
- **iPhone:** Search for "Spotify" in the Apple App Store to find and install the most current version.
- **Android:** Search for "Spotify" in Google play to find and install the most current version.
- iPhones are connected on either USB or Bluetooth.
- Android devices are connected on Bluetooth.
- To connect a smartphone via Bluetooth, register it as the Bluetooth device and do the App (SPP) profile setting of the connection beforehand. See **Register from the Bluetooth unit (P.49)** and **Connect the Bluetooth unit (P.50)**.

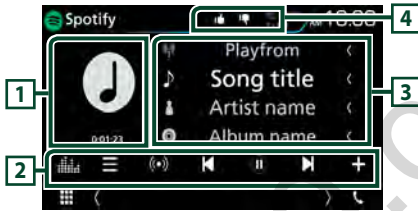

1 Artwork/ Playing time

- The picture data is displayed if available from current content.
- For confirmation of play time.

2 Function bar

- : Displays the Menu screen
- : New radio station that relates to the artist of the currently playing song is selected and playback starts.
- , : Skips the current song.
- : Plays or pauses the content of the current station.
- : Saves currently playing song to My Music.
- : Displays the Graphic Equalizer screen. (P.71)

3 Content information

Displays the information of the current content being played.



- : Thumbs down to the current contents and skip to the next contents.
- : Registers the current contents as favorite content.
- : Repeats the current song.
- : Randomly plays all song in current playlist.

Selecting a track

- 1 Touch .
 > Menu screen appears.
- 2 Select the list type, then select a desired item.

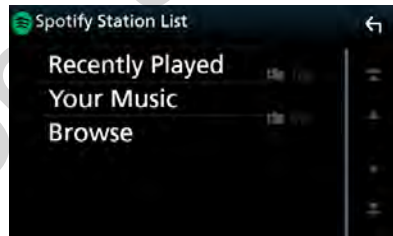

Selects the category and station

Touch the category and station name in the list.

Top

Returns to the first hierarchy of the list.

Up

Returns to the previous list.

About Spotify®**iPhone or iPod touch**

- Install the latest version of the Spotify application on your iPhone or iPod touch. (Search for “Spotify” in the Apple App Store to find and install the most recent version.)

Android™

- Visit Google play and search for “Spotify” to install.

Note

- Ensure you are logged in to your smartphone application. If you do not have an Spotify account, you can create one for free from your smartphone or at www.spotify.com.
- Because Spotify is a third-party service, the specifications are subject to change without prior notice. Accordingly, compatibility may be impaired or some or all of the services may become unavailable.
- Some functions of Spotify cannot be operated from this unit.
- For issues using the application, contact Spotify at www.spotify.com.
- Establish an Internet connection.

130.com.ua

Radio

Radio Basic Operation

Most functions can be controlled from the source control screen.

To enter Radio source, touch **Radio** icon in the source selection screen. (P.14)

Control screen



Preset list screen



1 Information display

Displays the information of the current station: Frequency

Touching  allows you to switch between Content A and Content B.

Content A: PS name, Radio Text, Title & Artist

Content B: PTY Genre, Radio Text plus



Preset#: Preset number

2 AUTO1 / AUTO2 / MANUAL

Switches the seek mode in the following sequence; **AUTO1**, **AUTO2**, **MANUAL**.

- **AUTO1**: Tunes in a station with good reception automatically.
- **AUTO2**: Tunes in stations in memory one after another.
- **MANUAL**: Switches to the next frequency manually.

3 Function bar

-  : Tunes in a station. The method of frequency switching can be changed (see 2 in table).
- : Displays the Graphic Equalizer screen. (P.71)

4 Preset key

Recalls the memorized station.

- Touch on the right side of the screen to display the Preset list. Touch again to close the list.

5 Function panel

Touch on the left side of the screen to display the function panel. Touch again to close the panel. For details on the keys, see **Function panel** (P.41).

6 FM AM

Switches the band.

7 Preset list

Recalls the memorized station.

When touched for 2 seconds, stores the current receiving station in memory.

8 Indicator Items

- **ST**: A stereo broadcast is being received.
- **MONO**: The forced monaural function is on.
- **AF**: The AF search function is on.
- **EON**: The Radio Data System station is sending EON.
- **LOS**: The Local Seek function is on.
- **NEWS**: News bulletin interruption is in progress.
- **RDS**: Indicates the state of the Radio Data System station when the AF function is on.
 - White: Radio Data System is being received.
 - Orange: Radio Data System is not being received.
- **TI**: Indicates the reception state of traffic information.
 - White: TP is being received.
 - Orange: TP is not being received.

Function panel

- 1 Touch on the left side of the screen.

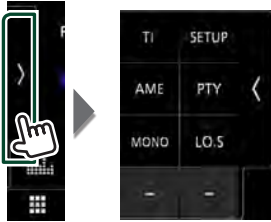

The functions of each key are as follows.

TI (FM only)

Sets the traffic information mode on. For details, see **Traffic Information (P.42)**.

SETUP

Displays the TUNER SETUP screen. For details, see **Tuner Setup (P.43)**.

AME

Presets stations automatically. For details, see **Auto memory (P.41)**.

PTY (FM only)

Searches a program by setting program type. For details, see **Search by program type (P.42)**.

MONO (FM only)

Select the Monaural reception.

LO.S (FM only)

Turns the Local Seek function on or off.

Memory Operation

Auto memory

You can store stations with good reception in memory automatically.

- 1 Touch desired band key.



- 2 Touch on the left side of the screen.
Touch **AME**.



- 3 Touch **Yes**.

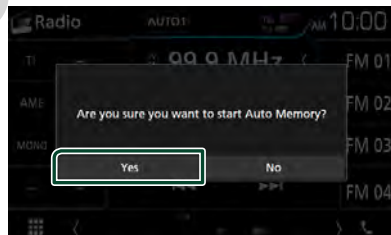

➤ Auto memory starts.

Manual memory

You can store the current receiving station in memory.

- 1 Select a station you wish to store in memory.
- 2 Touch **FM#** (#:1-15) or **AM#** (#:1-5) in which you want to store the station for 2 seconds until a beep sounds.

Selecting Operation

Search by program type (FM only)

You can tune to a station with a specific program type when listening to FM.

- 1 Touch on the left side of the screen. Touch **PTY**.

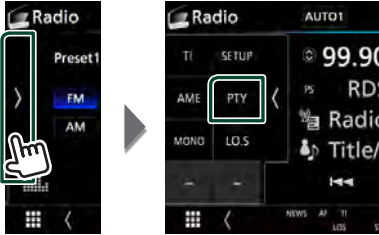

> PTY Search screen appears.

- 2 Select a program type from the list.
- 3 Touch **Search**.

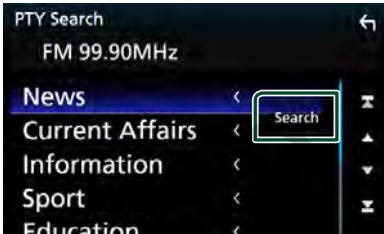

You can search a station of the selected program type.

Traffic Information (FM only)

You can listen and watch the traffic information automatically when a traffic bulletin starts. However, this feature requires a Radio Broadcast Data System that includes the TI information.

- 1 Touch on the left side of the screen. Touch **TI**.



> Traffic information mode is set.

When the traffic bulletin starts

The Traffic Information screen appears automatically.

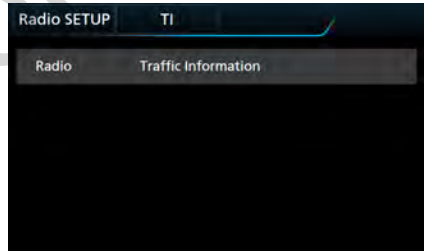

NOTE

- It is necessary to have Traffic Information function set to on in order to have the Traffic Information screen appear automatically.
- The volume setting during reception of traffic information is automatically stored. The next time the traffic information is received, this unit recalls the volume setting automatically.

Tuner Setup

You can set tuner related parameters.

- 1 Touch on the left side of the screen.
Touch **SETUP**.

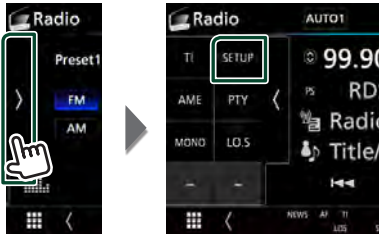

▶ Radio SETUP screen appears.

- 2 Set each item as follows.

NEWS

Sets a news bulletin interrupt time. Default is "OFF".

AF

When station reception is poor, automatically switches to the station that is broadcasting the same program over the same Radio Data System network. Default is "ON".

Regional

Sets whether to switch to the station only in the specific region using the "AF" control. Default is "ON".

Auto TP Seek

When traffic information station reception is poor, automatically searches for a station that can be received better. Default is "ON".

Language Select

Selects a display language for the PTY function.

DAB (DNX3 DNX7) DNX5170DABS/ DNX317DABS)

DAB Basic Operation

Most functions can be controlled from the source control screen.

To enter DAB source, touch **DAB** icon in the source selection screen. (P.14)

Control screen



Preset list screen

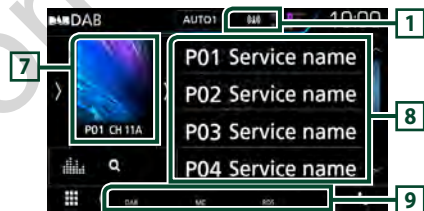

1 Indicator display

Displays the received signal strength.

2 Information display

Displays the information of the current station:
Service Name

Touching  allows you to switch between Content A, Content B and Content C.

Content A: Ensemble name, PTY Genre

Content B: Song Title, Artist Name, DLS

Content C: Now Playing, Next Program, Audio Quality

3 AUTO1 / AUTO2 / MANUAL

Switches the seek mode in the following sequence; **AUTO1**, **AUTO2**, **MANUAL**.

- **AUTO1**: Tunes in an ensemble with good reception automatically.
- **AUTO2**: Tunes in ensemble in memory one after another.
- **MANUAL**: Switches to the next ensemble manually.

4 Function bar

- **Q**: Displays the Service List screen. For details on search operation, see **Service search (P.45)**.
- **◀▶▶▶**: Tunes in an ensemble, service, and component. The seek mode switching can be changed. (see 3 in table).
- **EQ**: Displays the Graphic Equalizer screen. **(P.71)**

5 Preset key

Recalls the memorized service.

Touching on the screen or flicking the screen to left will display the Preset list. Touching again or flicking to right will close the list.

6 Function panel

Touch on the left side of the screen to display the function panel. Touch again to close the panel. For details on the keys, see **Function panel (P.44)**.

7 Artwork area

The picture data is displayed if available from current content.

Touch to switch between the Control and Information screen.

P#: Preset number

CH#: Channel display

8 Preset list

Recalls the memorized service. When touched for 2 seconds, stores the current service in memory.

9 Indicator Items

- **DAB**: Digital Radio is being received.
- **RDS**: Radio Data System is being received.
- **MC**: Receiving service is displayed.
White: Primary Component is received.
Orange: Secondary Component is received.

Function panel

1 Touch on the left side of the screen.

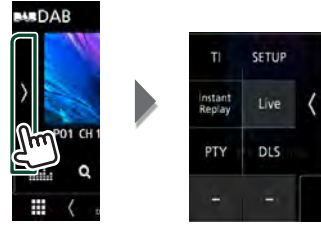

The functions of each key are as follows.

TI

Sets the traffic information mode on. For details, see **Traffic Information (P.46)**.

SETUP

Displays the DAB SETUP screen. For details, see **DAB Setup (P.47)**.

Instant Replay (Live mode only)

Change the Replay mode. See **Replay (P.46)**.

Live (Replay mode only)

Change the Live mode.

PTY (Live mode only)

Searches a program by setting program type. For details, see **Search by program type (P.45)**.

DLS

Display the Dynamic Label Segment screen.

Information screen

1 Touch to switch between the Control and Information screen.



Storing Service in Preset Memory

You can store the current receiving service in memory.

- 1 Select a service you wish to store in memory.
- 2 Touch on the right side of the screen.

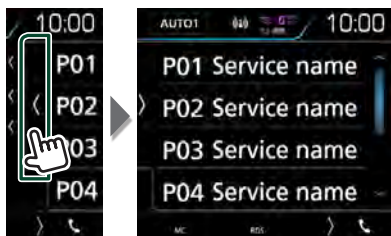

- 3 Touch P# (#:1-15) in which you want to store the station for 2 seconds until a beep sounds.

Selecting Operation

Search by program type

You can tune to a station with a specific program type when listening to Digital Radio.

- 1 Touch on the left side of the screen. Touch PTY.



➤ PTY Search screen appears.

- 2 Select a program type from the list.

3 Touch Search.

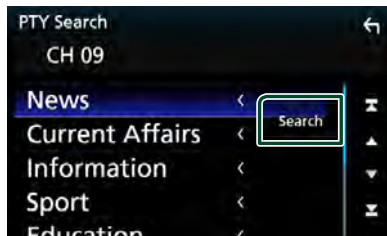

You can search a station of the selected program type.

Service search

You can select a service from a list of all services received.

- 1 Touch Q.



- 2 Select the desired content from the list.

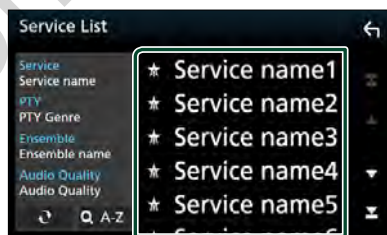

Touch and hold to find the latest service list.

Q,A-Z

Displays the keyboard screen.

Jump to the letter you entered (alphabet search).

Traffic Information

You can listen and watch the traffic information automatically when a traffic bulletin starts. However, this feature requires a Digital Radio that includes the TI information.

- 1 Touch on the left side of the screen.
Touch **TI**.



► Traffic information mode is set.

When the traffic bulletin starts

The Traffic Information screen appears automatically.



NOTE

- It is necessary to have Traffic Information function set to on in order to have the Traffic Information screen appear automatically.
- The volume setting during reception of traffic information is automatically stored. The next time the traffic information is received, this unit recalls the volume setting automatically.

Replay

You can replay last 30 minutes of current station.

- 1 Touch on the left side of the screen.
Touch **Instant Replay**.

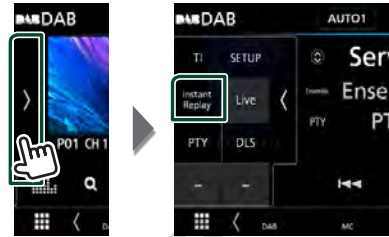

Forward/backward 15 seconds when touch it.



Fast forward/fast backward when keep on touching. (It will be cancelled automatically after about 50 seconds.)



Plays or pauses.

Replay time bar

Display recorded capacity

To return to live

- 1 Touch on the left side of the screen.
- 2 Touch **Live**.

NOTE

- PTY Watch starts operating and Replay function cannot be used while receiving a program.
- While replaying the current station, you can not store the station by **Storing Service in Preset Memory (P.45)**.

DAB Setup

You can set Digital Radio related parameters.

- 1 Touch on the left side of the screen.
Touch **SETUP**.



► DAB SETUP screen appears.

- 2 Set each item as follows.

■ Priority

If the same service is provided by Digital Radio during Radio Data System reception, automatically switches to Digital Radio. If the same service is provided by Radio Data System when reception of the service being provided by Digital Radio becomes poor, automatically switches to Radio Data System.

■ PTY Watch

If the service of the set program type begins with the ensemble being received, switches from any source to Digital Radio for service reception.

■ Announcement Select

Switches to the set Announcement service. For details, see **Announcement setup (P.47)**.

■ Seamless Blend

Prevents audio break when switching from Digital Radio to Analog Radio. Default is "ON".

■ Antenna Power

Sets power supply to the Digital Radio antenna. Set to "ON" when the Digital Radio antenna in use is equipped with a booster. Default is "ON".

■ L-Band Tuning

Sets L-band reception. When set to "ON", also receives L-band ensembles.

When the setting is changed, the preset services are initialized.

■ Related Service

When you select ON, the unit switches to a related service (if exists) when a DAB service network is not available.

Default is "OFF".

■ Language Select

Selects a display language for the PTY function.

■ Announcement setup

When the service for which ON is selected starts, switches from any source to Announcement to receive it.

- 1 Touch **Announcement Select** in the DAB SETUP screen.

► The Announcement Select screen appears.

- 2 Touch each Announcement list and set on or off.



■ Select All

Turn on the all announcements.

■ Deselect All

Turn off the all announcements.

NOTE

- The volume setting during reception of Announcement service is automatically stored. The next time the Announcement service is received, this unit recalls the volume setting automatically.

Bluetooth Control

Using the Bluetooth function, various functions can be used: listening to the audio file, making/receiving a call.

Information for using Bluetooth® devices



Bluetooth is a short-range wireless radio communication technology for mobile devices such as mobile phones, portable PCs, and other devices.

Bluetooth devices can be connected without cables and communicate with each other.

NOTE

- While driving, do not perform complicated operations such as dialing numbers, using the phone book, etc. When you perform these operations, stop your car in a safe place.
- Some Bluetooth devices may not connect to this unit depending on the Bluetooth version of the device.
- This unit may not work for some Bluetooth devices.
- Connecting conditions may vary depending on your environment.
- For some Bluetooth devices, the device is disconnected when the unit is turned off.

About the cell-phone and Bluetooth audio player

This unit conforms to the following Bluetooth specifications:

Version

Bluetooth Ver. 3.0

Profile

Cell-phone:

- HFP (V1.6) (Hands Free Profile)
- SPP (Serial Port Profile)
- HID (Human Interface Device Profile)
- PBAP (Phonebook Access Profile)

Audio player:

- A2DP (Advanced Audio Distribution Profile)
- AVRCP (V1.5) (Audio/Video Remote Control Profile)

Sound codec

SBC, AAC

NOTE

- For the cell-phones verified for compatibility, access the following URL:
<http://www.kenwood.com/cs/ce/bt/>
- The units supporting the Bluetooth function have been certified for conformity with the Bluetooth Standard following the procedure prescribed by Bluetooth SIG.
- However, it may be impossible for such units to communicate with your cell-phone depending on its type.

Register from the Bluetooth unit

It is necessary to register the Bluetooth audio player or cell-phone to this unit before using the Bluetooth function.

You can register up to 10 Bluetooth units.

NOTE

- Up to 10 Bluetooth units can be registered. If an attempt is made to register the 11th Bluetooth unit, the Bluetooth unit connected on the earliest date will be deleted to register the 11th one.
- This unit is compatible with the Apple Easy Pairing function. When an iPod touch or iPhone is connected to this unit, an authentication dialog appears. Performing operation for authentication on this unit or iOS smartphone registers the smartphone as a Bluetooth device.

Follow the step 1, 2 and 3 for registration.

Step 1: Registration from the Bluetooth device

- 1 Search the unit ("DNX****") from your smartphone/cell-phone.
- 2 Input the PIN code in your smartphone/cell-phone.
PIN code is set to "0000" as the default.

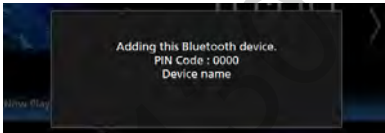

● SSP (Secure Simple Pairing of Bluetooth 2.1 or later)

- 1 Search the unit ("DNX****") from your smartphone/cell-phone.
- 2 Confirm the request both on the smartphone/cell-phone and the unit.



Step 2: Connection settings

- When the HFP profile is supported, Hands Free 1 or 2 is automatically selected for connection, proceeding to the next step.
 - When the A2DP or SPP profile is supported, the cell-phone or audio player is automatically connected, proceeding to the next step.
- If cell-phones and/or audio players have already been connected, a selection screen appears.

- 1 Select the hands-free number to connect.
A name of a smartphone is displayed when it has hands-free connection with the unit.

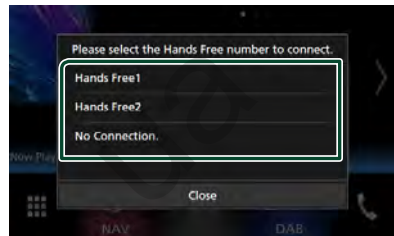

- 2 Select if you want to use the audio player app in your smartphone over A2DP, and the other apps in your smartphone over SPP.

This message appears if the device supports BT audio (A2DP) or smartphone link (SPP).

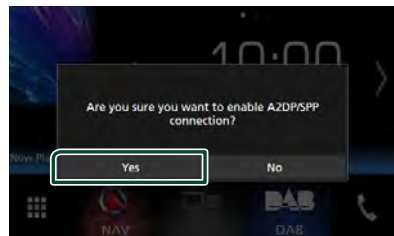

Step 3: Phonebook transfer

1 Select if you want to transfer your phonebook data.

This message appears if the device supports PBAP.

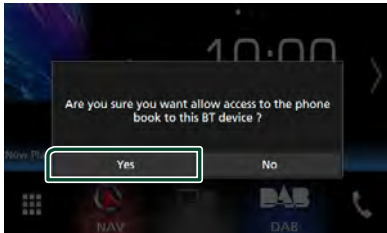

The phonebook data transmission starts. Some smartphones may request permission to access the data. The data transmission will start with your permission.



When the data transmission and connection have completed, the Bluetooth connection icon appears on the screen.

Bluetooth Setup

1 Press the **MENU** button.

➤ Popup menu appears.

2 Touch **SETUP**.



➤ SETUP Menu screen appears.

3 Touch **Bluetooth**.



➤ Bluetooth SETUP screen appears.

See the following section for each setting.

- Connect the Bluetooth unit (P.50)
- Change the PIN code (P.52)
- Change the device name (P.52)

Connect the Bluetooth unit

1 Touch **Select Device** in the Bluetooth SETUP screen.



- 2** Touch the device name you want to connect.

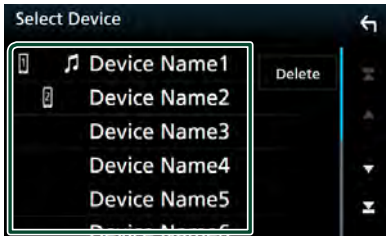

➤ Profile select screen appears.

NOTE

- If the icon is lighted, it means that the unit will use that device.

- 3** Set each profile as follows.

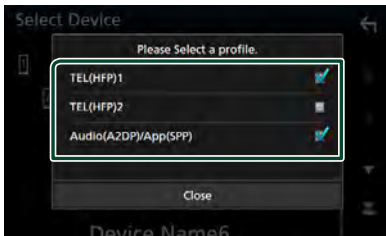

■ **TEL (HFP) 1, TEL (HFP) 2**

The device is connected with the unit as hands-free phone 1 or 2.

■ **Audio (A2DP)/App (SPP)**

Set to interwork with an application installed in a smartphone or to use as an audio player.

- 4** Touch **Close**.

NOTE

- If a device has been paired, the Bluetooth unit cannot be connected from the paired device.

To delete the registered Bluetooth unit

- 1** Touch **Delete**.

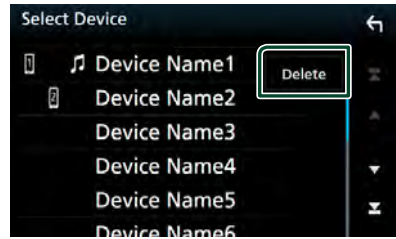

- 2** Touch the device name to check.

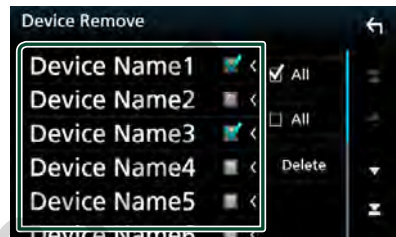

■ **All**

Select all Bluetooth unit.

■ **All**

Erases all check marks.

- 3** Touch **Delete**.

➤ Confirmation message appears.

- 4** Touch **Yes**.

Change the PIN code

- 1 Touch **PIN Code** in the Bluetooth SETUP screen.
 - PIN Code Set screen appears.
- 2 Input the PIN code.

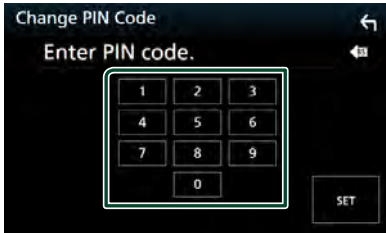

- 3 Touch **SET**.

Change the device name

- 1 Touch **Device Name** in the Bluetooth SETUP screen.
 - Change Device Name screen appears.
- 2 Input the device name.



- 3 Touch **Enter**.

Playing Bluetooth Audio Device

Most function can be controlled from the source control screen.

To enter Bluetooth source, touch **Bluetooth** icon in the source selection screen. (P.14)

Bluetooth basic operation

Control screen

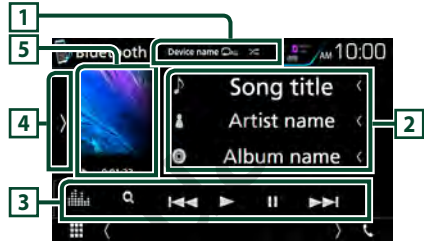

1 Device name/ [Repeat] / [Shuffle]

- Connected device name.
- [Repeat]: Repeats the current track/folder. Each time you touch the key, repeat mode switches in the following sequence; File repeat ([Repeat]), Folder repeat ([Repeat]), All songs repeat ([Repeat]), Repeat off ([Repeat]).
- [Shuffle]: Randomly plays all tracks in current folder. Each time you touch the key, random mode switches in the following sequence; Folder random ([Shuffle]), All random ([Shuffle]), Random off ([Shuffle]).

2 Information display *

Displays the name of the track information.

3 Function bar *

- [Search]: Searches file. See **File search (P.53)**.
- [Previous/Next]: Searches the previous/next content. Touch and hold to fast forward or fast backward. (It will be cancelled automatically after about 50 seconds.)
- [Play]: Plays.
- [Pause]: Pauses.
- [Equalizer]: Displays the Graphic Equalizer screen. (P.71)

4 Function panel

Touch on the left side of the screen to display the function panel. Touch again to close the panel.

- **BT DEVICE CHANGE** : Selects the device to connect via Bluetooth audio (A2DP) or APP (SPP). See **Connect the Bluetooth audio (P.53)**.

5 Play mode indicator/ Playing time

▶, II: Current play mode indicator

The meanings of each icon are as follows;

▶ (play), ▶▶ (fast forward), ◀◀ (fast backward), II (pause), ■ (stop).

* These items appear only when the audio player which supports AVRCP profile is connected.

NOTE

- If the operation keys do not appear, operate from the player.
- Depending on your cell-phone or audio player, audio may be heard and controlled but text information may not appear.
- If the volume is too low, raise it on your cell-phone or audio player.

Connect the Bluetooth audio

Selects the device to connect via Bluetooth audio (A2DP) or APP (SPP).

- 1 Touch on the left side of the screen. Touch **BT DEVICE CHANGE**.

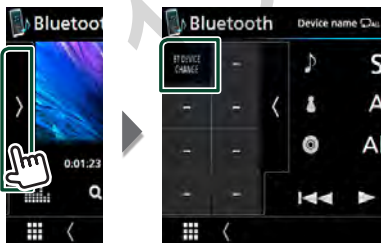

- 2 Touch the device name you want to connect.

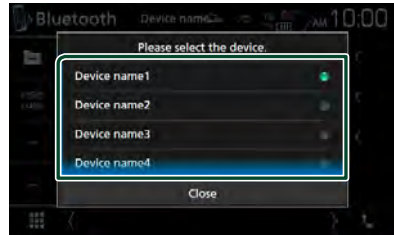

- 3 Touch **Close**.

File search

- 1 Touch **Q**.
- 2 Touch the desired file or folder.

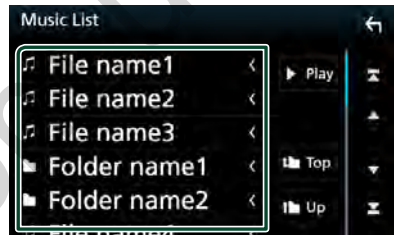

When you touch a folder its contents are displayed.

- 3 Touch desired item from the content list.
 - ▶ Playback starts.

NOTE

- For operations in the list screen, see **List screen (P.18)**.

Using Hands-Free Unit

You can use telephone function by connecting the Bluetooth telephone to this unit.

NOTE

- While Apple CarPlay or Android Auto is being connected, Bluetooth Hands-Free function and two Bluetooth devices connections cannot be used. Only Apple CarPlay or Android Auto Hands-Free function can be used.

Make a call

1 Touch .

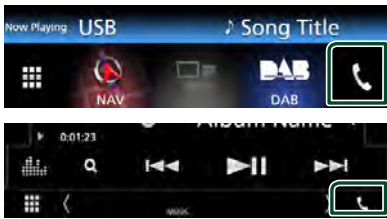





► Hands Free screen appears.

NOTE

- If your mobile phone supports PBAP, you can display the phone book and call lists on the touch panel screen when the mobile phone is connected.
 - Phone book: up to 1000 entries
 - Up to 50 entries including dialed calls, received calls, and missed calls

2 Select a dialing method.



- : Call using call records
- : Call using the phonebook
- : Call using the preset number
- : Call by entering a phone number
- : Voice Recognition (P.55)

● Select the cell-phone to use

When you connect two cell-phones

- 1) Touch   to select the phone you want to use.

● Bluetooth SETUP

- 1) Touch .
Bluetooth SETUP screen appears.

NOTE

- The status icons such as battery and antenna displayed may differ from those displayed on the cell-phone.
- Setting the cell-phone in the private mode can disable the hands-free function.

Call using call records

1 Touch .

2 Select the phone number from the list.



Call by entering a phone number

1 Touch .

2 Enter a phone number with number keys.

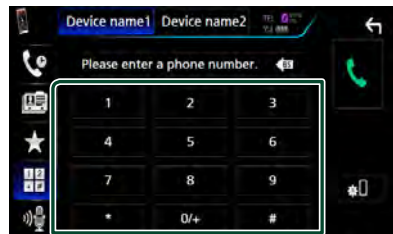



3 Touch .

Call using the preset number

- 1 Touch .
- 2 Touch the Name or phone number.



Call using the phonebook

- 1 Touch .
- 2 Touch .
- 3 Select the initial.



- Characters with no corresponding name will not appear.
- During search, a non-accent character such as "u" is searched for instead of an accent character such as "ü".

- 4 Select the person you want to call from the list.

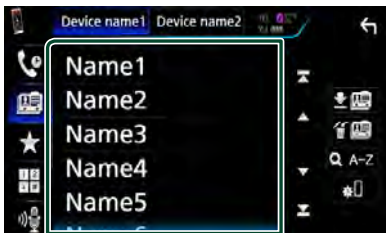

- 5 Select the phone number from the list.



NOTE

- You can set the list to arrange in the order of last name or first name. For details, see **Hands-Free Setup (P.58)**.

Voice Recognition

You can access the voice recognition function of the cell-phone connected to this unit. You can search the cell-phone phonebook by voice. (The functionality depends on the cell-phone.)

- 1 Press the  button for 1 second.

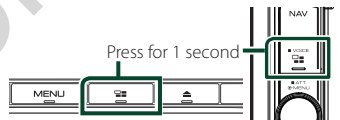



- Voice Recognition screen appears.

- 2 Start speaking.

NOTE

- You can use voice recognition function by touching  on the Hands Free screen.

Receive a call

- 1 Touch  to answer a phone call or  to reject an incoming call.



NOTE

- While monitoring the view camera, this screen does not appear even if a call comes in. To display this screen, press the **TEL** button or return the shift knob of car to the driver position.

To end call

- 1 While talking, touch .

Operations during a call

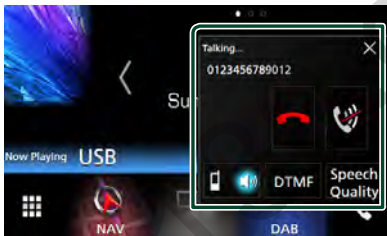

● **Adjust the volume of your voice**

- 1) Touch **Speech Quality**.
- 2) Touch ◀ or ▶ of **Microphone Level**.

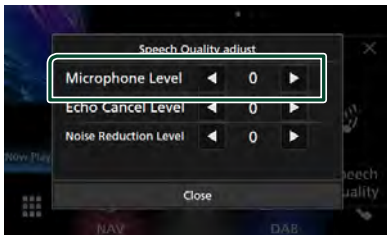

● **Adjust the receiver volume**

DNX8 DNX7

Press the ▼ or ▲ button.

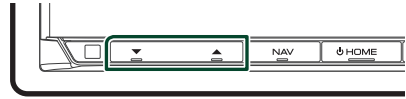

DNX5 DNX3

Turn to the right to increase, and turn to the left to decrease.





● **Mute your voice**

Touch  to mute or not to mute your voice.

● **Output the dial tone**



Touch **DTMF** to display the tone input screen. You can send tones by touching desired keys on the screen.

● **Switching the speaking voice output**

Touching  /  each time switches the speaking voice output between cell-phone and speaker.

● **Call-waiting**

When you receive a call while talking on another call, you can answer the newly received call by touching . The current call is on hold.

Each time you touch , the caller will change. When you touch , the current call will end and switch to the call in hold.

● ×

The Hands-Free popup screen is closed. To display it again, touch .

Phone number preset

You can register frequently used phone numbers to this unit.

- 1 Touch .
- 2 Touch **Edit**.



- 3 Select where to preset.



- 4 Select how to preset.

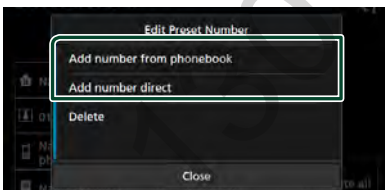

- **Add number from phonebook:**

Select the number to preset by referring to "Call using the phonebook". See **Call using the phonebook (P.55)**.

- **Add number direct:**

Enter the telephone number directly and touch **SET**. See **Call by entering a phone number (P.54)**.

NOTE

- To delete the preset number, touch **Delete** and then touch **Yes** on the confirmation screen.

Phonebook transfer

You can transfer the phonebook in your Bluetooth smartphone via PBAP.

- 1 Touch .
- 2 Touch .

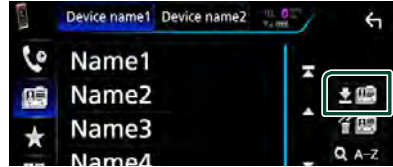

➤ The phonebook data transmission starts.

Phonebook deletion

- 1 Touch .
- 2 Touch the name to check.

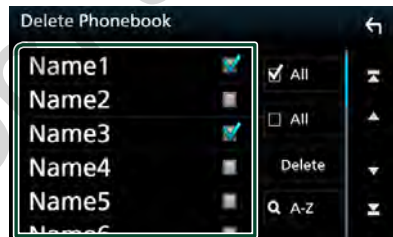

- **All**

Checks all boxes.

- **All**

Erases all check marks.

- 3 Touch **Delete**.

➤ Confirmation message appears.

- 4 Touch **Yes**.

Hands-Free Setup

You can perform various setup about handsfree function.

1 Press the **MENU** button.

- Popup menu appears.

2 Touch **SETUP**.

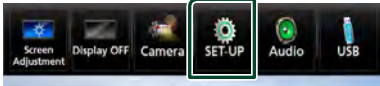

- SETUP Menu screen appears.

3 Touch **Bluetooth**.



- Bluetooth SETUP screen appears.

4 Touch **TEL SETUP**.

- TEL SETUP screen appears.

5 Set each item as follows.



■ **Bluetooth HF/Audio**

Select the speakers to output the sound from cell-phone (such as phone call voice and ringing tone) and Bluetooth audio player.

Front: Outputs from the front speakers.

All (Default): Outputs from all speakers.

■ **Auto Response***

Sets an automatic response time to pick-up an incoming call.

OFF (Default): Automatic response is not available.

1/ 5/ 10/ 15/ 20/ 25/ 30: Set calling ring time (second).

■ **Auto Pairing**

When set to "ON", the Apple Auto Pairing function is turned on to automatically register the iPod touch or iPhone connected to this unit.

ON (Default): Uses Apple Auto Pairing function.

OFF: Not uses Apple Auto Pairing function.

■ **Sort Order**

Sets how to arrange the cell-phone phonebook.

First: Arranges in the order of first name.

Last (Default): Arranges in the order of last name.

■ **Echo Cancel Level**

Adjusts the level of echo cancellation.

Default is "0".

■ **Noise Reduction Level**

Reduces the noises generated by surrounding environment without changing the microphone volume. Use this setting when the voice of caller is not clear. Default is "0".

* Either the time interval for automatic answer set on this unit or the time interval set on the cell-phone, whichever is shorter takes effect.

6 Touch **OK**.

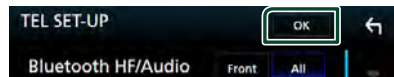

Other External Components

View Camera

NOTE

- To connect a camera, see **P.81**.
- To use a rear view camera, a REVERSE lead connection is required. (**P.80**)
- The view of the front view camera or dashboard camera varies depending on the setting of **Dashboard Camera /Front Camera**.
- If **R-CAM Interruption** is set to on, the camera screen is displayed when you shift the gear to the reverse (R) position.

Display the camera screen

- 1 Press the **MENU** button.
 - Popup menu appears.

- 2 Touch **Camera**.



- View camera screen appears.

- 3 Adjust each item as follows.

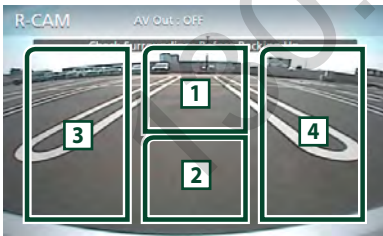

- 1 **Switching the View Camera**

Touch to change the front view camera^[1] or dashboard camera^[2] and rear view camera.

- 2 **Camera off**

Touch to exit the camera screen.

- 3 **Switching the Guideline**

Touching each time turns on or off the guideline. Available when **Rear Camera** is set to **CMOS 3-Series Camera**.

- 4 **Switching the Angle**

Touching each time changes camera angles:

Available when **Dashboard Camera / Front Camera** is set to **CMOS 3-Series Camera**.

- ^[1] Only for **DNX8** **DNX7**
- ^[2] Only for **DNX8** **DNX7** **DNX5**

Camera Setup

- 1 Press the **MENU** button.

➤ Popup menu appears.

- 2 Touch **SETUP**.

➤ SETUP Menu screen appears.

- 3 Touch **Camera**.

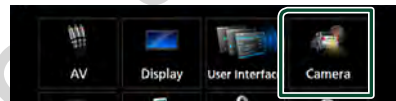

➤ Camera screen appears.

- 4 Set each item as follows.

■ Rear Camera (**DNX8** **DNX7**)

CMOS 3-Series Camera: Select this when the CMOS-3xx series with ID 1 set is connected.

Other (Default): Select this when the other camera is connected.

■ R-CAM Interruption

ON: Displays the picture from the rear view camera when you shift the gear to the reverse (R) position.

OFF (Default): Select this when no camera is connected.

■ R-CAM for Car interface

ON: Select when you connected an external system unit. Neither buttons nor titles are displayed.

OFF (Default): Select when you connected a rear camera.

Other External Components

■ R-CAM Settings (DNX3 DNX7)

If you select **CMOS 3-Series Camera** for **Rear Camera**, adjusts the CMOS-3xx series with ID 1 set. For details, see the instruction manual of your camera.

■ Parking Guidelines

You can display parking guidelines to enable easier parking when you shift the gear to the reverse (R) position.

Default is "ON".

■ Guidelines SETUP

If you select **ON** for **Parking Guidelines**, adjust the parking guidelines. See *To adjust the parking guidelines (P.60)*.

■ Dashboard Camera /Front Camera (DNX3 DNX7)

Dashboard Camera: Select this when the dashboard camera is connected.

CMOS 3-Series Camera: Select this when the CMOS-3xx series with ID 2 set is connected.

Other: Select this when the other camera is connected.

OFF (Default): Select this when no camera is connected.

■ F-CAM Settings (DNX3 DNX7)

If you select **CMOS 3-Series Camera** for **Dashboard Camera /Front Camera**, adjusts the CMOS-3xx series with ID 2 set. For details, see the instruction manual of your camera.

■ Front Camera Mirror Image (DNX3 DNX7)

If you select **ON** for **Dashboard Camera / Front Camera**.

ON: Displays the picture from the front view camera horizontally reversed.

OFF (Default): Displays the picture from the front view camera as it is.

■ Dashboard Camera (DNX5)

ON: Select this when the dashboard camera is connected.

OFF (Default): Select this when no camera is connected.

To adjust the parking guidelines

NOTE

- Install the rear view camera in the appropriate position according to the instructions supplied with the rear view camera.
- When adjusting the parking guidelines, make sure to use the parking brake to prevent the car from moving.

1 Touch ON of Parking Guidelines in the Camera screen. (P.59)

2 Touch Guidelines SETUP in the Camera screen.

3 Adjust the parking guidelines by selecting the  mark.

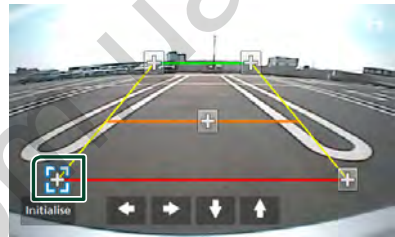

4 Adjusting the position of the selected mark.

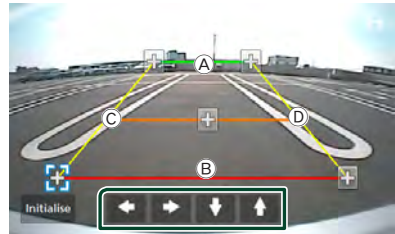

Make sure that (A) and (B) are horizontally parallel, and that (C) and (D) are the same length.

NOTE

- Touch **Initialize** and after touch **Yes** to set all the  marks to the initial default position.

Use Dashboard Camera (DNX8 DNX7 DNX5)

A Dashboard Camera, DRV-N520 (optional accessory), connected to this unit lets you play video-recorded data and so on.

For details, see the instruction manual of the Dashboard Camera DRV-N520 (optional accessory).

NOTE

- To connect a dashboard camera, see **P.84**.
- Sets the dashboard camera/front camera as **Dashboard Camera**. (**P.60**)

Display the dashboard camera screen

- 1 Press the **MENU** button.
 - ▶ Popup menu appears.

- 2 Touch **Camera**.



1 Switching the View Camera

Touch to change the dashboard view camera and rear view camera.

2 Camera off

Touch to exit the camera screen.

3 Key display

Touch to display the dashboard camera control buttons.

External audio/video players— AV-IN

- 1 Connect an external component to the AV-IN input terminal. (**P.81**)
- 2 Select **AV-IN** as the source. (**P.14**)
- 3 Turn on the connected component and start playing the source.

HDMI/ MHL source

- 1 Connect your smartphone to the HDMI/ MHL input terminal. (**P.81**)
Use HDMI cable KCA-HD100 (optional accessory) or MHL cable KCA-MH100 (optional accessory).
- 2 Select **HDMI/MHL** as the source. (**P.14**)
- 3 Start an application or playback on your smartphone.

● About Wireless Display Adapter:

This unit is compatible with Wireless Display Adapter. Connecting a Wireless Display Adapter (KCA-WL100; optional accessory) to the HDMI/ MHL input terminal enables you to enjoy listening to music, watching videos, or viewing pictures over a wireless connection.

NOTE

- For details about Wireless Display Adapter settings, etc., refer to the instructions supplied with the Wireless Display Adapter.

TV tuner (DNX8 DNX7 DNX5)

You can connect the TV tuner (commercially available) with this unit and watch TV.

Preparation

- When you use TV control function, connect the TV tuner (commercially available) and set 3rd Party TV Tuner Control in **AV Setup (P.68)** to ON.
- The TV tuner can be controlled with its supplied remote control through the remote sensor on the front panel of this unit.

1 Select AV-IN as the source. (P.14)

2 Touch Key display area.



3 Touch TV Ctrl.



■ **Displays the menu/ Enters selected item**

Touch **MENU/OK**.

■ **Moves the cursor**

Touch **▲, ▼, ◀, ▶**.

■ **Exits menu control**

Touch **⬅**.

Setting Up

Monitor Screen Setup

You can adjust image quality in video, menu screen, etc.

1 Press the MENU button.

➤ Pop up menu appears.

2 Touch Screen Adjustment.

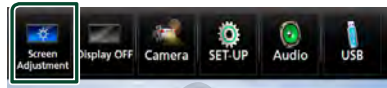

➤ Screen Control screen appears.

3 Adjust each item as follows.



■ **Backlight / Contrast / Black / Brightness / Color / Tint**

Adjusts each item.

■ **Aspect**

Select screen mode.

Full: Changes the aspect ratio of video and displays fully on the screen.

Normal: Displays with 4:3 ratio.

Auto:

DVD, VCD and disc media: Video of 16:9 ratio is displayed in Full and video of 4:3 ratio is displayed in Regular.

USB device and SD card: Displays video fully on vertical or horizontal with no ratio change.

NOTE

- Adjusting items are different depending on the current source.

System Setup

NOTE

- Each operation in this section can be started from the multi function menu.

- 1 Press the **MENU** button.
 - Popup menu appears.
- 2 Touch **SETUP**.

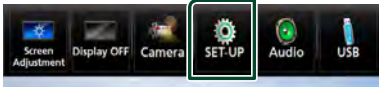

See the following section for each setting.

- Set up AV (**P.68**)
- Set up display (**P.66**)
- Set up the user interface (**P.63**)
- Set up camera (**P.59**)
- Set up special (**P.65**)
- Set up Bluetooth (**P.50**)
- Set up security (**P.11**)
- Set up navigation (**P.21**)

User Interface Setup

You can setup user interface parameters.

- 1 Press the **MENU** button.
 - Popup menu appears.
- 2 Touch **SETUP**.
 - SETUP screen appears.
- 3 Touch **User Interface**.



➤ User Interface screen appears.

- 4 Set each item as follows.

■ Steering Remote Controller

Sets the desired function in the steering remote controller. (Contact your KENWOOD dealer for details.)

■ Beep (DNX7 DNX5 DNX3)

Turns the key touch tone on or off. Default is "ON".

■ Beep Volume (DNX3)

Sets the sound volume of the key touch tone.

"0" (Off) – "3" (Default) – "5"

■ Vehicle Adaptor Information*1

Displays the vehicle information.

This function requires a commercial adaptor. Consult your KENWOOD dealer for details.

■ Beep for Parking distance control*1

Sets whether to generate a warning tone when the onboard proximity sensor detects a human or object.

Consult your KENWOOD dealer for details.

■ Parking Distance Display*1

You can display information about obstacles around the car.

ON: Always displays information.

Dyn. (Default): Displays information when the sensor detects obstacles.

OFF: Cancels.

This function requires a commercial adaptor. Consult your KENWOOD dealer for details.

Setting Up

■ Parking Distance Position*1

Select where information about obstacles is displayed on the screen (left or right).

"Left"/"Right" (Default)

This function requires a commercial adaptor.

Consult your KENWOOD dealer for details.

■ Language Select Mode

Selects the mode to select a language.

Easy (Default): Selects a language easily.

Advanced: Allows you to select languages for respective items.*2

■ Language Select

Selects a language.

■ Touch Panel Adjust

(**DNX7** **DNX5** **DNX3**)

Adjust the sensing position of touch panel.

(P.64)

■ Clock

NAV-SYNC (Default): Synchronizes the clock time with navigation.

Manual: Sets the clock manually

■ Time Zone

If you have selected **Manual** for Clock, select the time zone.

■ Clock Adjust

If you select **Manual** for Clock, adjust the date and time manually. (P.64)

*1 This setting is available when a commercial adaptor is connected.

*2 If you select **Advanced for Language Select Mode**, the following screen appears.



■ GUI Language Select

Selects the display language used for the control screen and so forth.

■ Navigation Language Select

Selects the language used for navigation.

■ Adjust the date and time manually.

1 Touch **Time Zone** in the User Interface screen.

2 Select the time zone.

3 Touch **Clock Adjust** in the User Interface screen.

4 Adjust the date, then adjust the time.

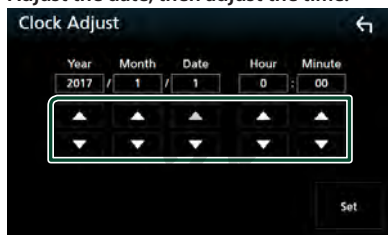

5 Touch **Set**.

■ Touch panel adjustment

(**DNX7** **DNX5** **DNX3**)

1 Touch **Touch Panel Adjust** on the User Interface screen.

> Touch Panel Adjust screen appears.

2 Follow the instruction on the screen and long touch the center of each .

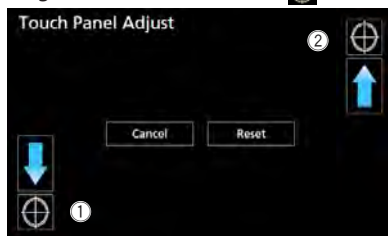

NOTE

- To cancel the touch panel adjustment, touch **Cancel**.
- To reset to the initial status, touch **Reset**.

Special Setup

You can setup Special parameters.

1 Press the **MENU** button.

➤ Popup menu appears.

2 Touch **SETUP**.

➤ SETUP screen appears.

3 Touch **Special**.

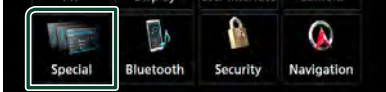

➤ Special screen appears.

4 Set each item as follows.

■ DEMO

Set the demonstration mode. Default is "OFF".

■ Manual Power OFF

Assigns the function of the HOME button when held.

AV OFF: Turns off the screen and audio. Interrupts from incoming hands-free calls, rear camera views and so on are functional, though.

Complete OFF (Default): Switches off the power. Interrupts are not functional.

■ SETUP Memory

Locks or unlocks the Audio SETUP Memory/Recall/Clear.

■ Audio SETUP Memory

Memorizes the current audio setting.

- Fader/ Balance, Speaker / X'over, Equalizer (User Preset, SW Level), Position/DTA, Sound Effect **(P.68)**

■ Audio SETUP Recall

Recalls the memorized audio setting.

■ Audio SETUP Clear

Clears the AUDIO SETUP Memory and the currently memorized audio setting.

■ Software Information

Check the software version of this unit. **(P.65)**

■ Open Source Licenses

Displays the open source licenses.

■ Initialize

Touch **Initialize** and then touch **Yes** to set all the settings to the initial default settings.

- Audio SETUP Memory is not initialized.

■ Software Information

Check the software version of this unit.

1 Touch **Software Information** in the Special screen.

2 Confirm the software version.



NOTE

- For how to update the software, see the relevant update procedure manual which comes with the software.

Display Setup

- 1 Press the **MENU** button.
 - Popup menu appears.
- 2 Touch **SETUP**.
 - SETUP screen appears.
- 3 Touch **Display**.

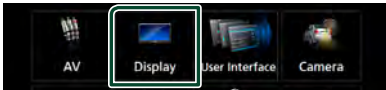

➤ Display screen appears.

- 4 Set each item as follows.

■ Dimmer

Select dimmer mode.

OFF: The display and buttons do not dim.

ON: The display and buttons dim.

SYNC (Default): Turns the dimmer function on or off when the vehicle light control switch is turned on or off.

NAV-SYNC: Turns the dimmer function on or off according to the Navigation Day/Night display setting.

■ OSD Clock

Select if you want to display the clock while watching DVD video, etc.

"ON" (Default)/ "OFF"

■ Key Color

You can set the button illumination color. (P.66)

■ Background

Changing background image or color. (P.67)

■ Viewing Angle

If it is hard to see the image on the screen even after adjusting the front panel angle, adjust the viewing angle. The smaller the (negative) value, the more whitish the image on the screen looks.

"0" (Default)/ "-1"/ "-2"/ "-3"

■ Customizing the key color

You can set the button illumination color.

- 1 Touch **Key Color** in the Display screen.
- 2 Touch the desired color.

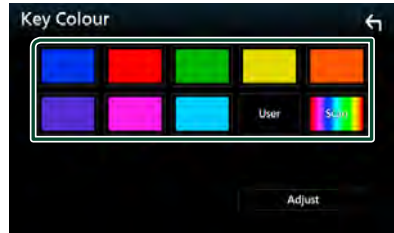

■ User

The color you have set in the process of **Adjust** is registered.

■ Scan

You can set the key color to continuously scan through the color spectrum.

- 3 Touch .

To register original color

You can register your original color.

- 1 Touch **User** in the Key Color screen.
- 2 Touch **Adjust**.
- 3 Use **-** and **+** to adjust each color value.

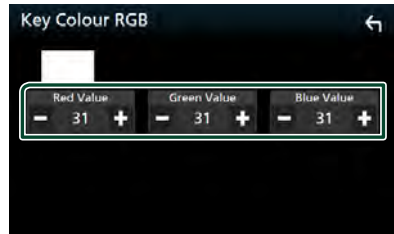

- 4 Touch .

Change background image or color

- 1 Touch **Background** in the Display screen.
- 2 Select an image.

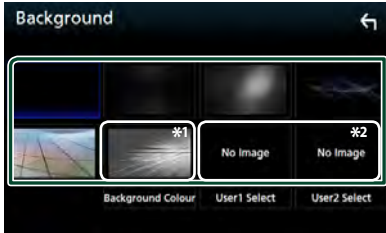

*1 Select a background color in advance.

*2 Select an original image in advance.

To select background color

- 1 Touch **Background Colour** in the Background screen.
- 2 Select a background color.

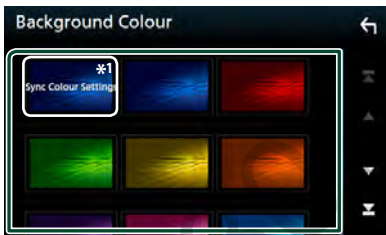

*1 The color you have selected at **Key Color** is added on the image. If you select "Scan" at **Key Color**, you cannot select this image.

- 3 Touch .

To register original image

You can load an image from the connected USB device and set it for the background image.

Before operating this procedure, it is necessary to connect the device which has the image to load.

- 1 Touch **User1 Select** or **User2 Select** in the Background screen.
- 2 Select the image to load.

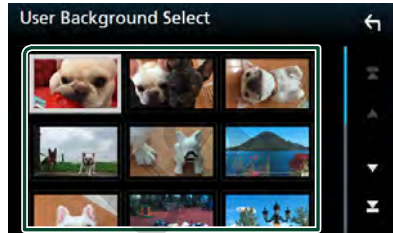

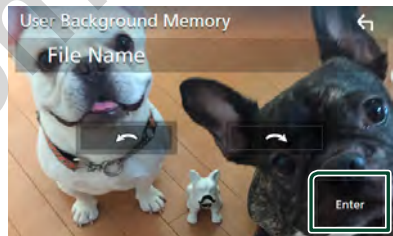

- 3 Touch **Enter**.



➤ The selected image is loaded and the display returns to the Background screen.

NOTE

- Touching  rotates counter clockwise.
- Touching  rotates clockwise.
- Picture files: JPEG (.jpg, .jpeg), PNG (.png), BMP (.bmp)

AV Setup

You can set AV parameters.

- 1 Press the **MENU** button.
 - Popup menu appears.
- 2 Touch **SETUP**.
 - SETUP screen appears.
- 3 Touch **AV**.

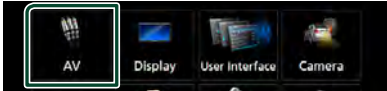

➤ AV screen appears.

- 4 Set each item as follows.

■ iPod Bluetooth Connection

See **Select the method of making connections for outputting sound from the iPod source. (P.31)**

■ TV Tuner Control (except **DNX3**)

Sets when connecting the TV tuner to AV INPUT.

ON: Set to ON when connecting the 3rd party TV tuner. AV-IN1 Name is set to TV. If you connect the TV tuner made by DOS and watch TV, you can perform some simple operations by touching the screen of this unit.

OFF (Default): Set to OFF when not connecting the 3rd party TV tuner.

■ AV-OUT

You can select an AV source to be output from the AV OUTPUT port.

OFF, AV-IN, DISC, USB, SD, or iPod

You cannot select iPod if it is connected via Bluetooth.

If you select USB, SD, iPod, Disc, Spotify, Mirroring, Bluetooth audio, Apple CarPlay or Android Auto as the main source, you cannot select USB, SD or iPod as the AV output source.

■ CarPlay Sidebar

Select the position of the control bar (left or right) shown on the touch panel.

"Left" (Default)/"Right"

Controlling Audio

NOTICE

- Each operation in this section can be started from the multi function menu.

You can adjust the various settings such as audio balance or subwoofer level.

- 1 Press the **MENU** button.
 - Popup menu appears.

- 2 Touch **Audio**.

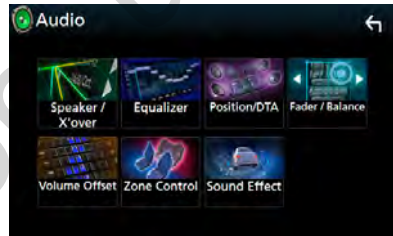
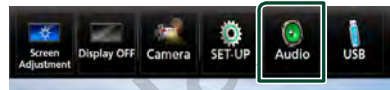

See the following section for each setting.

- Set up speaker/ X'over (**P.69**)
- Controlling equalizer (**P.71**)
- Set listening position/ DTA (**P.74**)
- Controlling general audio (Fader / Balance) (**P.71**)
- Set volume offset (**P.72**)
- Performing zone control (**P.73**)
- Set sound effect (**P.73**)

Speaker/ X'over setup

- 1 Press the **MENU** button.
➤ Popup menu appears.
- 2 Touch **Audio**.
➤ Audio screen appears.
- 3 **DNX8** **DNX7** **DNX5**
Touch **Speaker/X'over**.
DNX3
Touch **Speaker**.

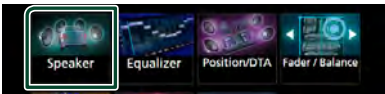
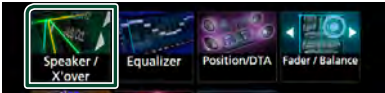

- 4 Select a car type.

You can setup the car type and speaker network, etc.

If your car type is selected, the Delay Time Alignment is set automatically (for timing adjustment of sound output for each channel) to have the highest surround effects.



- 5 Touch the speaker (①) you wish to adjust and set each item (②) as follows.



■ Speaker

You can select a speaker type and its size to get the best sound effects.

When the speaker type and size are set, the speaker crossover network is set automatically.

■ Location (Only for Front, Rear)

Select the speaker position you have fixed.

■ Tweeter (Only for Front) (DNX8 DNX7 DNX5)

You can set the tweeter when you are selecting front speakers.

None, Small, Medium, Large

■ X'over (DNX8 DNX7 DNX5)

Displays the speaker crossover setup screen.

You can adjust the crossover setup that was set automatically when you selected the speaker type.

For details, see **Crossover network setup (P.69)**

When Speaker network is set to 3 way (DNX8 DNX7 DNX5):



NOTE

- For how to switch to the 3-way speaker system, see **3 way speaker system setup (P.70)**. Connecting 3-way speakers with the 2-way mode selected can break the speakers.
- Select "None" if you have no speakers.

■ Crossover network setup (DNX8 DNX7 DNX5)

You can set a crossover frequency of speakers.

- 1 Touch **X'over**.

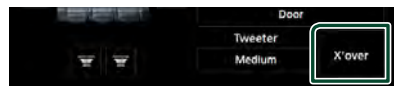

- 2 Touch the speaker to set.



3 Set each item as follows.

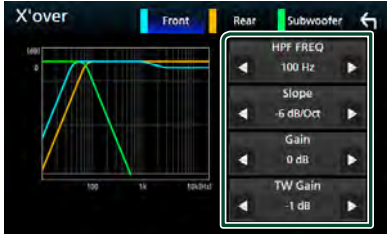

■ **HPF FREQ**

High Pass Filter adjustment. (When front or rear speaker is selected on Speaker Select screen)

■ **LPF FREQ**

Low Pass Filter adjustment. (When subwoofer is selected on Speaker Select screen)

■ **Slope***1

Sets a crossover slope.

■ **Gain**

Adjusts the front speaker, rear speaker, or subwoofer level.

■ **TW (Tweeter) Gain** *2

Adjusts the tweeter level. (When front is selected on Speaker Select screen)

■ **Phase Inversion***3

Sets the phase of subwoofer output.

Check **Phase Inversion** to shift the phase 180 degrees. (When subwoofer is selected on Speaker Select screen)

*1 Only when "LPF FREQ"/"HPF FREQ" is set to a mode other than "Through" in **X'over**.

*2 Only when "Tweeter" is set to "Small", "Medium", "Large" in **Speaker Setup**.

*3 Only when "Subwoofer" is set to a mode other than "None" in **Speaker Setup**.

When Speaker network is set to 3 way:

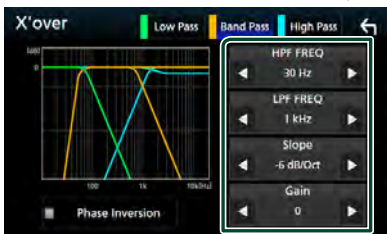

■ **FREQ (High Pass)**

High Pass Filter adjustment. (When tweeter is selected on Speaker Select screen)

■ **HPF FREQ, LPF FREQ (Band Pass)**

Band Pass Filter adjustment. (When mid range speaker is selected on Speaker Select screen)

■ **FREQ (Low Pass)**

Low Pass Filter adjustment. (When woofer is selected on Speaker Select screen)

■ **Slope***1

Sets a crossover slope.

■ **Gain**

Sets gain of each speaker.

■ **Phase Inversion***3

Sets the phase of tweeter, mid range, and woofer output.

Check **Phase Inversion** to shift the phase 180 degrees.

NOTE

- For how to switch to the 3-way speaker system, see **3 way speaker system setup (P.70)**. Connecting 3-way speakers with the 2-way mode selected can break the speakers.

3 way speaker system setup (DNX3 DNX7 DNX5)

Select the appropriate crossover network mode according to the speaker system (2-way speaker system or 3-way speaker system).

1 Press the **HOME** button.

➤ HOME screen appears.

2 Touch .

➤ Source selection screen appears.

3 Touch **STANDBY**.

4 Press the  button and the **NAV** button for 1 second at the same time.



➤ Speaker system select screen appears.

5 Select the crossover network mode.



➤ A confirmation screen appears.

6 Touch Yes.

NOTE

- When the 3-way speaker system is selected, the following functions are disabled.
 - Zone Control
 - Fader of Controlling General Audio
 - Front focus of Listening Position/ DTA
 - Select the speakers to output the sound from cell-phone of Bluetooth HF/Audio
 - Beep of User Interface Setup
- Connecting 3-way speakers with the 2-way mode selected can break the speakers.

Controlling General Audio

1 Press the MENU button.

➤ Popup menu appears.

2 Touch Audio.

➤ Audio screen appears.

3 Touch Fader / Balance.

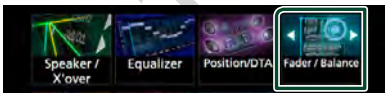

4 Set each item as follows.

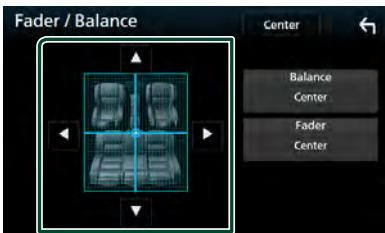

Fader / Balance

Adjust the volume balance around the touched area.

◀ and ▶ adjust the right and left volume balance.

▲ and ▼ adjust the front and rear volume balance.

Center

Clear the adjustment.

Equalizer Control

You can adjust equalizer by selecting the optimized setting for each category.

1 Press the MENU button.

➤ Popup menu appears.

2 Touch Audio.

➤ Audio screen appears.

3 Touch Equalizer.

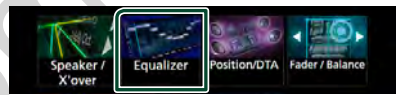

4 Touch the screen and set the Graphic Equalizer as desired.

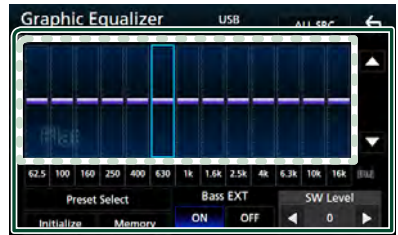

Gain level (dotted frame area)

Adjust the gain level by touching the each frequency bar.

You can select frequency bar and adjust its level by ▲, ▼.

Preset Select

Displays the screen to recall the preset equalizer curve.

Memory

Saves the adjusted equalizer curve from "User1" to "User4".

Controlling Audio

■ Initialize

The current EQ curve returns to flat.

■ ALL SRC

Apply the adjusted equalizer to all sources. Touch **ALL SRC** and then touch **OK** on the confirmation screen.

■ Bass EXT (Bass Extend Settings)

When turned on, the frequency lower than 62.5 Hz is set to the same gain level as 62.5 Hz.

■ SW Level (DNX8) (DNX7) (DNX5)

Adjusts the subwoofer volume. This setting is not available when subwoofer is set to "None". See *Speaker/ X'over setup (P.69)*.

■ Recall the EQ curve

1 Touch **Preset Select**.

2 Select EQ curve.



NOTE

- iPod is available only during iPod source.

■ Save the EQ curve

1 Adjust the EQ curve.

2 Touch **Memory**.

3 Select where to save.



Volume Offset

Finely adjust the volume of the current source to minimize the difference in volume between different sources.

1 Press the **MENU** button.

> Popup menu appears.

2 Touch **Audio**.

> Audio screen appears.

3 Touch **Volume Offset**.

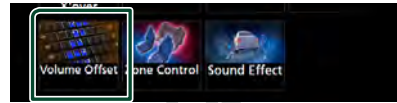

4 Touch + or - to adjust the level.



■ Initialize

Returns to the initial settings.

* If you have increased the volume first, then reduced the volume using the "Volume Offset", the sound generated if you suddenly switch to another source may be extremely loud.

Zone Control

You can select different sources for both front and rear positions in the vehicle.

1 Press the **MENU** button.

- Popup menu appears.

2 Touch **Audio**.

- Audio screen appears.

3 Touch **Zone Control**.

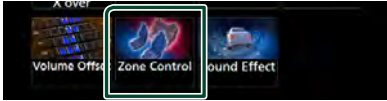

- Zone Control screen appears.

4 Touch **Zone Select**.

5 Touch **Dual Zone**.

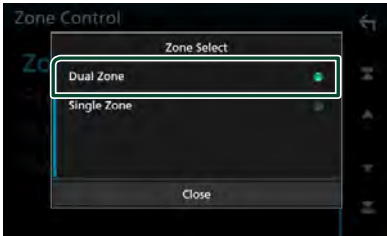

6 Set each source as follows.



■ **Zone Select**

Touch **Single Zone** to turn off the dual zone function.

■ **Front Source Rear Source**

Select the audio source for each.

■ **Rear VOL.**

Adjusts the rear source volume.

NOTE

- When the rear speaker sound is switched, the audio source that is output at the AV OUTPUT terminal is also switched to the same source.
- When the dual zone function is set to on, the following functions are not available.
 - Output from the subwoofer
 - Subwoofer Level/ Bass Boost (**P.73**)
 - Equalizer Control/ Sound Effect/ Listening Position (**P.71, 73, 74**)
 - Speaker Setup (**P.69**)
 - High-resolution Sound Source File Playback
- You cannot select iPod if it is connected via Bluetooth.
- If you select USB, SD, iPod, Disc, Mirroring, Bluetooth audio, Apple CarPlay or Android Auto as the Front Source, you cannot select USB, SD or iPod as the Rear Source.

Sound Effect

You can set sound effects.

1 Press the **MENU** button.

- Popup menu appears.

2 Touch **Audio**.

- Audio screen appears.

3 Touch **Sound Effect**.



4 Set each item as follows.



■ **Bass Boost**

Sets the amount of bass boost among "OFF"/"1"/"2"/"3".

■ **Loudness**

Sets the amounts of boost of low and high tones.

"OFF", "Low", "High"

Controlling Audio

■ Drive Equalizer+

The sound quality is automatically optimized to meet the current car speed by GPS.
"OFF"/"ON"

■ Space Enhancer

Select the feeling of sound space enhancement.
"OFF"/"Small"/"Medium"/"Large".

■ Supreme

Turns ON/OFF the Supreme function. Technology to extrapolate and supplement with proprietary algorithm, the high-frequency range that is cut off when encoding.

■ Realizer

Virtually makes the sound more realistic using the Digital Signal Processor (DSP) system.
Select the level from "OFF"/"1"/"2"/"3".

■ Stage EQ

You can adjust the height of speakers virtually to suit your listening position.
"OFF"/"Low"/"Middle"/"High".

Listening Position/DTA

Listening Position/DTA allows you to improve the sound field depending on the position of the seat you sit.

Listening Position/DTA allows you to set "Listening Position" and "Front Focus". You cannot set both at the same time.

1 Press the **MENU** button.

➤ Popup menu appears.

2 Touch **Audio**.

➤ Audio screen appears.

3 Touch **Position/DTA**.

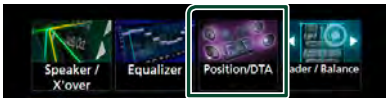

- Set up Listening Position (**P.74**)
- Set up Front Focus (**P.75**)

■ Listening Position

Adjust the sound delay time as nearer speakers to the selected seat have more delay time, so that the sound from each speaker arrive a listener at the same time.

1 Touch **Listening Position** in the Position/DTA screen.

2 Select listening position from **Front R** (Right front), **Front L** (Left front), **Front All** (All front), and **All**.



Position DTA control

You can fine-adjust your listening position.

1 Touch **Adjust**.

2 Touch **Delay**.

3 Touch ◀ or ▶ to adjust the delay time of the selected speaker.



4 Touch **Level**.

- 5 Touch ◀ or ▶ to adjust the sound level of the selected speaker.



NOTE

- To return to the initial setting of Delay and Level, touch **Initialize** and **YES** in the confirmation screen.
- DNX3**: You cannot set the subwoofer and tweeter.

Front Focus

This is the function to focus the imaginary sound image in front of the selected seat.

- 1 Touch **Front Focus** in the Position/DTA screen.
- 2 Select a front focus position. For **Front All** and **All**, select Priority L or R depending on which side you want to put the imaginary sound image.



Front Focus fine adjustment

- 1 Touch **Adjust**.
- 2 Touch **Delay**.
- 3 Set each item as follows.

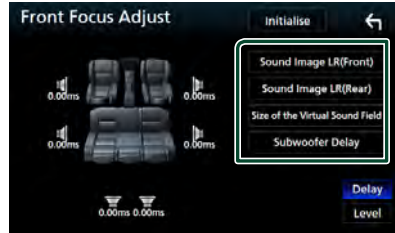

■ Sound Image LR (Front)

Adjust the sound image to focus on in front of front seats.

■ Sound Image LR (Rear)

Adjust the sound image to focus on in front of rear seats.

■ Size of the Virtual Sound Field

Adjust the size of sound image to meet your taste. If the sound image is shifted from the front, adjust it by **Sound Image LR (Front)** or **Sound Image LR (Rear)**.

■ Subwoofer Delay

(DNX3 DNX7 DNX5)

Adjust the delay time of subwoofer.

- 4 Touch **Level**.
- 5 Touch ◀ or ▶ to adjust the sound level of the selected speaker.



NOTE

- To return to the initial setting of Delay and Level, touch **Initialize** and **YES** in the confirmation screen.
- DNX3**: You cannot set the subwoofer and tweeter.

Connection/Installation

Before Installation

Before installation of this unit, please note the following precautions.

▲ WARNINGS

- If you connect the ignition wire (red) and the battery wire (yellow) to the car chassis (ground), you may cause a short circuit, that in turn may start a fire. Always connect those wires to the power source running through the fuse box.
- Do not cut out the fuse from the ignition wire (red) and the battery wire (yellow). The power supply must be connected to the wires via the fuse.

▲ CAUTION

- Install this unit in the console of your vehicle. Do not touch the metal part of this unit during and shortly after the use of the unit. Metal part such as the heat sink and enclosure become hot.

NOTE

- Mounting and wiring this product requires skills and experience. For best safety, leave the mounting and wiring work to professionals.
- Make sure to ground the unit to a negative 12V DC power supply.
- Do not install the unit in a spot exposed to direct sunlight or excessive heat or humidity. Also avoid places with too much dust or the possibility of water splashing.
- Do not use your own screws. Use only the screws provided. If you use the wrong screws, you could damage the unit.
- If the power is not turned ON ("There is an error in the speaker wiring. Please check the connections." is displayed), the speaker wire may have a short-circuit or touched the chassis of the vehicle and the protection function may have been activated. Therefore, the speaker wire should be checked.
- If your car's ignition does not have an ACC position, connect the ignition wires to a power source that can be turned on and off with the

ignition key. If you connect the ignition wire to a power source with a constant voltage supply, such as with battery wires, the battery may be drained.

- If the console has a lid, make sure to install the unit so that the front panel will not hit the lid when closing and opening.
- If the fuse blows, first make sure the wires aren't touching to cause a short circuit, then replace the old fuse with one with the same rating.
- Insulate unconnected wires with vinyl tape or other similar material. To prevent a short circuit, do not remove the caps on the ends of the unconnected wires or the terminals.
- Connect the speaker wires correctly to the terminals to which they correspond. The unit may be damaged or fail to work if you share the ⊖ wires or ground them to any metal part in the car.
- When only two speakers are being connected to the system, connect the connectors either to both the front output terminals or to both the rear output terminals (do not mix front and rear). For example, if you connect the ⊕ connector of the left speaker to a front output terminal, do not connect the ⊖ connector to a rear output terminal.
- After the unit is installed, check whether the brake lamps, blinkers, wipers, etc. on the car are working properly.
- Mount the unit so that the mounting angle is 30° or less.
- This unit has the cooling fan to decrease the internal temperature. Do not mount the unit in a place where the cooling fan of the unit is blocked. Blocking these openings will inhibit the cooling of the internal temperature and result in malfunction.

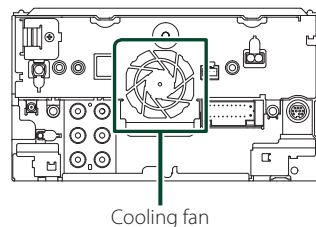



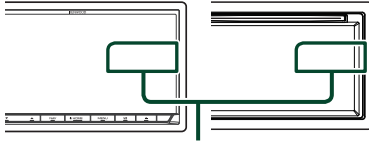



- Do not press hard on the panel surface when installing the unit to the vehicle. Otherwise scars, damage, or failure may result.
- Reception may drop if there are metal objects near the Bluetooth antenna.

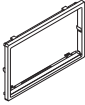

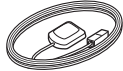
Bluetooth antenna unit

Supplied accessories for installation

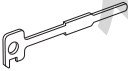
①  x1	⑥  x1
②  x1 (Black 1 m)	⑦  x1 (3.5 m)
③ ^[1]  x1 (Gray 1 m)	⑧  x1
④  x1 (3 m)	⑨ ^[2]  x1
⑤  x2	

^[1] DNX8 DNX7 DNX5 only

^[2] DNX8170DABS only

Installation procedure

- 1) To prevent a short circuit, remove the key from the ignition and disconnect the \ominus terminal of the battery.
- 2) Make the proper input and output wire connections for each unit.
- 3) Connect the wire on the wiring harness.
- 4) Take Connector B on the wiring harness and connect it to the speaker connector in your vehicle.
- 5) Take Connector A on the wiring harness and connect it to the external power connector on your vehicle.
- 6) Connect the wiring harness connector to the unit.
- 7) Install the unit in your car.
- 8) Reconnect the \ominus terminal of the battery.
- 9) Perform the Initial Setup.
See **Initial setup (P.10)**.

Installing the unit

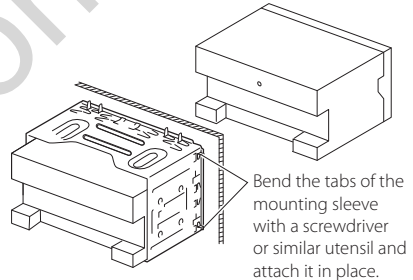

Trim plate

- 1) Attach accessory ⑥ to the unit.

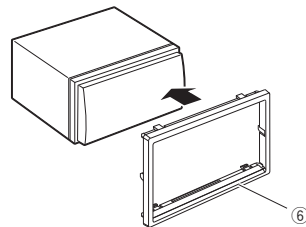

Connection/Installation

GPS antenna

GPS antenna is installed inside of the car. It should be installed as horizontally as possible to allow easy reception of the GPS satellite signals.

To mount the GPS antenna inside your vehicle:

- 1) Clean your dashboard or other surface.
- 2) Remove the separator of the metal plate (accessory ⑧).
- 3) Press the metal plate (accessory ⑧) down firmly on your dashboard or other mounting surface. You can bend the metal plate (accessory ⑧) to conform to a curved surface, if necessary.
- 4) Remove the separator of the GPS antenna (accessory ⑦), and stick the antenna to the metal plate (accessory ⑧).

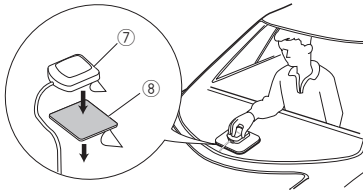

NOTE

- Depending on the type of car, reception of the GPS satellite signals might not be possible with an inside installation.
- Please install this GPS antenna in an area away from any antennas that are used with CB radios or satellite televisions.
- The GPS antenna should be installed at a position that is spaced at least 12 inch (30 cm) from cellular phone or other transmitting antennas. Signals from the GPS satellite may be interfered with by these types of communication.
- Painting the GPS antenna with (metallic) paint may cause a drop in performance.

Microphone unit

- 1) Check the installation position of the microphone (accessory ④).
- 2) Clean the installation surface.
- 3) Remove the separator of the microphone (accessory ④), and stick the microphone to the place shown below.
- 4) Wire the microphone cable up to the unit with it secured at several positions using tape or other desired method.

- 5) Adjust the direction of the microphone (accessory ④) to the driver.

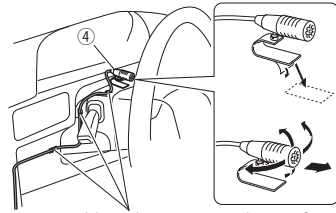

Fix a cable with a commercial item of tape.

Removing the trim plate

- 1) Engage the catch pins on the extraction key (accessory ⑤) and remove the two locks on the lower level.
Lower the trim plate (accessory ⑥) and pull it forward as shown in the figure.

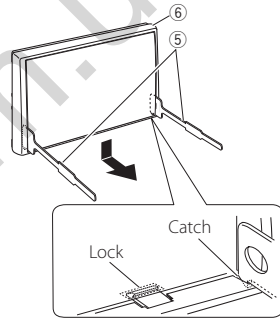

NOTE

- The trim plate can be removed from the top side in the same manner.

- 2) When the lower level is removed, remove the upper two locations.

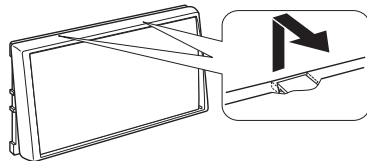

Removing the unit

- 1) Remove the trim plate by referring to step 1 in "Removing the trim plate".
- 2) Insert the two extraction key (accessory ⑤) deeply into the slots on each side, as shown.

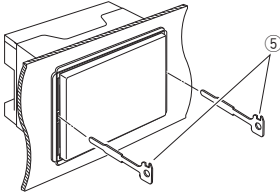

- 3) Lower the extraction key toward the bottom, and pull out the unit halfway while pressing towards the inside.

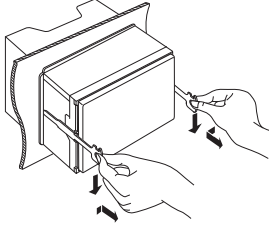

NOTE

- Be careful to avoid injury from the catch pins on the extraction key.

- 4) Pull the unit all the way out with your hands, being careful not to drop it.

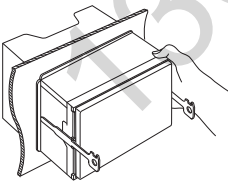

3 way speaker system setup (DNX3 DNX7 DNX5)

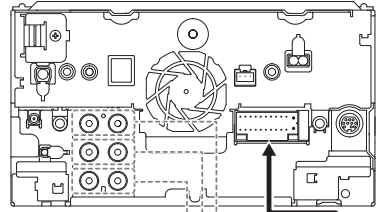

Subwoofer Preout

Mid Range Preout

Tweeter Preout

When connecting to an external amplifier, connect its ground wire to the car's chassis to avoid damaging the unit.

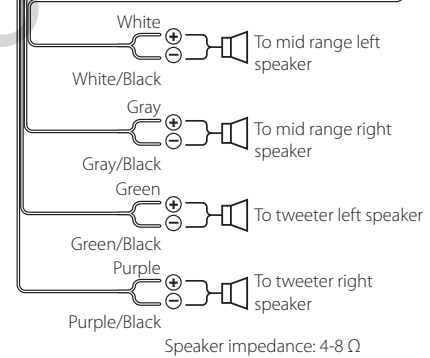
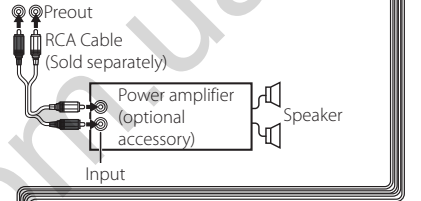

NOTE

- For speaker system setup, see **3 way speaker system setup (P.70)**.
- For speaker setup and crossover setup, see **Controlling Audio (P.68)**.
- For how to connect speaker wires to terminals other than speaker terminals and Preout terminals, see **Connecting the system and external components (P.81)** and **Connecting wires to terminals (P.80)**.

Connecting wires to terminals

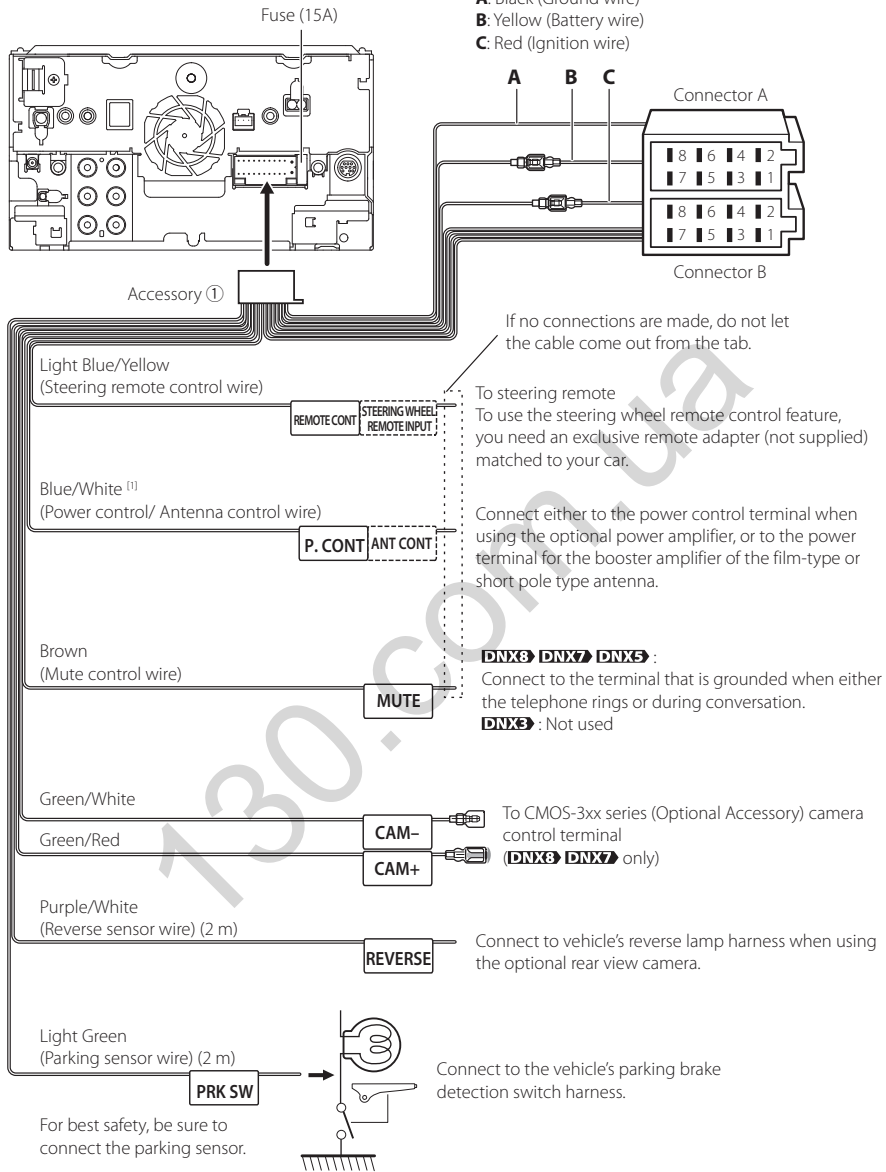

[1] [2]: Blue/White wire is provided two wires, [1] and [2]. Blue/White wire total output ([1] + [2]): 12 V \approx 350 mA

Wiring harness (Accessory connector function guide)

Pin	Color and function	
A-4	Yellow	Battery
A-5	Blue/White ^[2]	Power Control
A-6	Orange/White	Dimmer
A-7	Red	Ignition (ACC)
A-8	Black	Earth (Ground) Connection
B-1/ B-2	Purple (+) / Purple/Black (-)	Rear Right
B-3/ B-4	Gray (+) / Gray/Black (-)	Front Right
B-5/ B-6	White (+) / White/Black (-)	Front Left
B-7/ B-8	Green (+) / Green/Black (-)	Rear Left

*Speaker Impedance: 4-8 Ω

⚠ WARNING for Connecting the ISO Connector

The pin arrangement for the ISO connectors depends on the type of vehicle you drive. Make sure to make the proper connections to prevent damage to the unit. The default connection for the wiring harness is described in (1) below. If the ISO connector pins are set as described in (2), make the connection as illustrated. Please be sure to reconnect the cable as shown (2) below to install this unit to the Volkswagen vehicles etc.

(1): Default setting

The red (A-7 pin) of the vehicle's ISO connector is linked with the ignition, and the yellow (A-4 pin) is connected to the constant power supply.

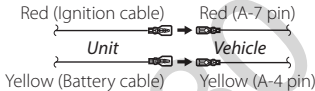

(2)

The red (A-7 pin) of the vehicle's ISO connector is connected to the constant power supply, and the yellow (A-4 pin) is linked to the ignition.

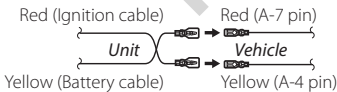

Connecting the system and external components

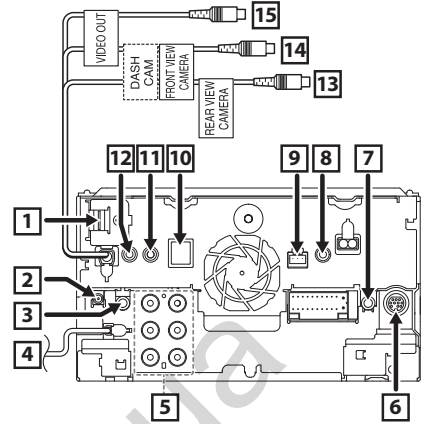

- HDMI/MHL input
MHL maximum power supply current :
5 V $\overline{\text{DC}}$ 900 mA
When you connect the cable to HDMI/MHL terminal, remove the fixture. After connecting the cable, put the fixture again.

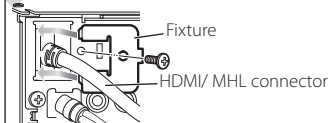

- DAB antenna CX-DAB1 (Optional accessory) (DNX8, DNX7, DNX5170DABS, DNX317DABS only)

⚠ Use of a CX-DAB1 (optional accessory) as a DAB antenna is recommended.

When using a commercially available DAB antenna, the diameter of the SMB connector must be $\Phi 6.5$ mm or less.

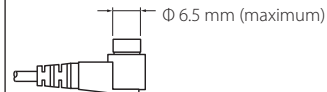

- AV Audio output ($\Phi 3.5$ mini jack)

- FM/AM antenna input

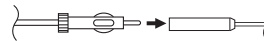

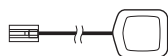
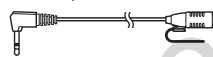
5	<p>When connecting to an external amplifier, connect its ground wire to the car's chassis to avoid damaging the unit. (DNX8 DNX7 DNX5) only</p> <div style="display: flex; align-items: center;">  </div>
6	<p>External I/F (DNX8 DNX7 DNX5) only Maximum power supply current : 12 V \equiv 500 mA</p>
7	<p>TV tuner remote output (DNX8 DNX7 DNX5) only</p>
8	<p>DNX8 DNX7 DNX5 : AV-IN (CA-C3AV; Optional Accessory) input DNX5 : AV-IN (CA-C3AV; Optional Accessory)/ Dashboard camera input</p>
9	<p>Dashboard camera interface Connect a Dashboard Camera DRV-N520 (optional accessory). (P.84) (DNX8 DNX7 DNX5) only</p>
10	<p>Accessory ⑦: GPS Antenna</p> 
11	<p>Accessory ④: Bluetooth Microphone</p> 
12	<p>Connect to vehicle's steering remote harness. Contact your KENWOOD dealer for details.</p>
13	<p>Rear view camera input (Yellow)</p>
14	<p>Front view camera/ Dashboard camera input (Yellow) (DNX8 DNX7) only</p>
15	<p>Visual Output (Yellow)</p>

Connecting a USB device

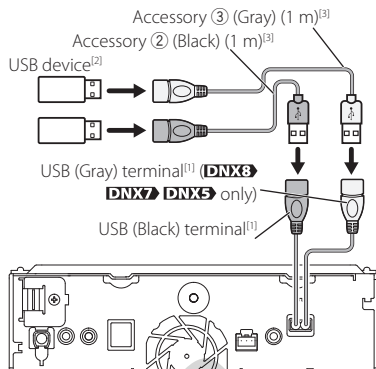

^[1] USB maximum power supply current :
 DC 5 V \equiv 1.5 A

^[2] Sold separately / Use CA-U1EX to extend the cable if necessary. (Max 500 mA, 5V)

^[3] See **Securing the USB extension cable (P.82)**.

Connecting the Wireless Display Adapter to use smartphone/iPod/iPhone over a wireless connection

Wireless Display Adapter: KCA-WL100
 (Sold separately)

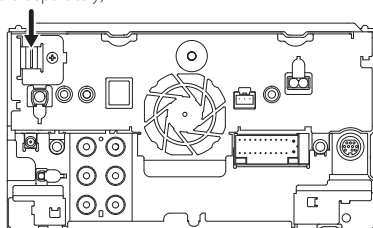

Securing the USB extension cable

Secure the USB extension cable with insulating tape or the like so that its connectors are not disconnected.

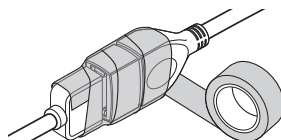

Connecting an iPod/iPhone

● Lightning connector

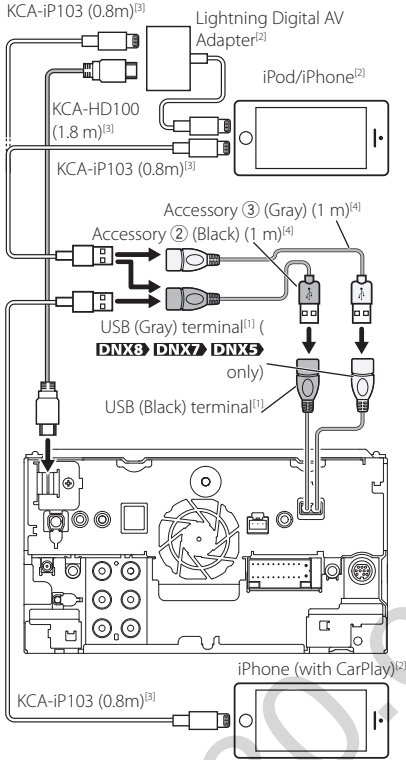

^[1] USB maximum power supply current :
DC 5 V $\overline{\text{---}}$ 1.5 A

^[2] Sold separately

^[3] Optional accessory

^[4] See **Securing the USB extension cable (P.82)**.

Connecting an Android smartphone

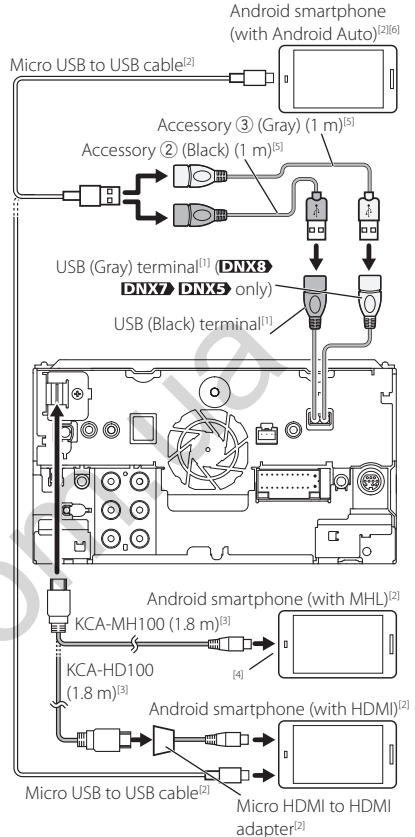

^[1] USB maximum power supply current :
DC 5 V $\overline{\text{---}}$ 1.5 A

^[2] Sold separately

^[3] Optional accessory

^[4] Use conversion adapter to connect to smartphones if necessary.

^[5] See **Securing the USB extension cable (P.82)**.

^[6] **DNX8 DNX7** only

Connecting a Dashboard camera

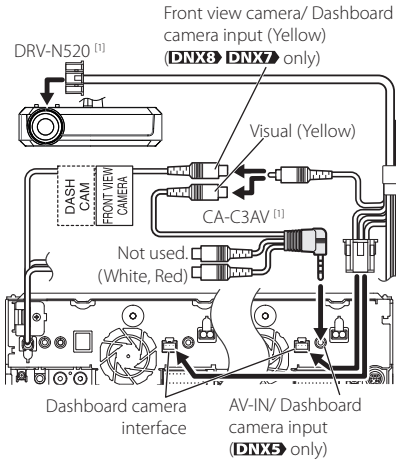

(1) Optional accessory

Troubleshooting

Problems and Solutions

If any trouble occurs, first check the following table for possible problems.

NOTE

- Some functions of this unit may be disabled by some settings made on this unit.
- What might seem to be a malfunction in your unit may just be the result of slight misoperation or miswiring.

About settings

- **Cannot set up the subwoofer.**
- **Cannot set up subwoofer phase.**
- **No output from the subwoofer.**
- **Cannot set up the low pass filter.**
- **Cannot set up the high pass filter.**

Subwoofer is not set to on.

- Set the subwoofer to on. See **Speaker/ X'over setup (P.69)**.

The dual zone function is enabled.

- Set the dual zone function to off. See **Zone Control (P.73)**.

- **Cannot select the output destination of the subsource in the dual zone.**
- **Cannot adjust the volume of the rear speakers.**

The dual zone function is disabled.

- Set the dual zone function to on. See **Zone Control (P.73)**.

- **Cannot set up the equalizer.**
- **Cannot set up the crossover network.**

The dual zone function is enabled.

- Set the dual zone function to off. See **Zone Control (P.73)**.

About audio operations

Radio reception is poor.

The car antenna is not extended.

- Pull out the antenna all the way.

The antenna control wire is not connected.

- Connect the wire correctly. See **Connecting the system and external components (P.81)**.

Cannot select a folder.

The random play function is enabled.

- Turn off the random function.

Cannot perform repeat play during VCD playback.

The PBC function is enabled.

- Turn off the PBC function.

The specified disc does not play, but another one plays instead.

The disc is quite dirty.

- Clean the disc. See **Precautions on handling discs (P.4)**.

The disc is severely scratched.

- Try another disc instead.

The sound skips when an audio file is being played.

The disc is scratched or dirty.

- Clean the disc. See **Precautions on handling discs (P.4)**.

The recording condition is bad.

- Record the file again or use another disc.

 **Other**

The Touch Sensor Tone doesn't sound.

The preout jack is being used.

- The Touch Sensor Tone cannot be output from the preout jack.

Error Messages

When you fail to operate the unit correctly, the cause of the failure appears as the message on the screen.

here is an error in the speaker wiring. Please check the connections.

Protective circuit has been activated because a speaker cord has shorted or it has come in contact with the car chassis.

- Wire or insulate the speaker cord as appropriate and turn the power off and on again.

Hot Error

When the internal temperature of this unit rises to 60°C or more, the protection circuit is activated and you may not be able to operate the unit.

- Use the unit again after reducing the temperature of the unit.

Mecha Error

The disc player is malfunctioning.

- Eject the disc and try inserting it again. Contact the KENWOOD dealer if this indicator continues blinking or the disc cannot be ejected.

Disc Error

An unplayable disc is inserted.

- Change the disc. See **Playable Media and Files (P.86)**.

Read Error

The disc is quite dirty.

- Clean the disc. See **Precautions on handling discs (P.4)**.

Disc is upside down.

- Load the disc with the labeled side up.

Region Code Error

The disc you wanted to play has a region code that cannot be played with this unit.

- See **Region Codes in the World (P.88)** or try another disc.

Error 07-67

The unit is not operating correctly due to some reason or other.

- Turn the power off and on again. If the "Error 07-67" message does not disappear, see your nearest KENWOOD dealer.

No Device (USB device)

The USB device is selected as a source although no USB device is connected.

- Change the source to any source other than USB/iPod. Connect a USB device, and change the source to USB again.

Disconnected (iPod, Bluetooth audio player)

The iPod/Bluetooth audio player is selected as a source although no iPod/Bluetooth audio player is connected.

- Change the source to any source other than iPod/Bluetooth. Connect an iPod/Bluetooth audio player, and change the source to iPod/Bluetooth again.

No Media file

The connected USB device contains no playable audio file. Media was played that doesn't have data recorded that the unit can play.

- See **Playable Media and Files (P.86)** and try another USB device.

USB device over current status detected.

The connected USB device is rated a current capacity higher than the allowable limit.

- Check the USB device. Some trouble may have occurred to the connected USB device.
- Change the source to any source other than USB. Remove the USB device.

Navigation Error. Please turn on power again later.

The communication error has occurred due to severely cold temperature.

- Turn on power again after warming your car interior.

Appendix

Playable Media and Files

You can play various kinds of media and files on this unit.

List of playable discs

Disc types / Standard		Support	Remark
DVD	DVD Video	○	
	DVD Audio	×	
	DVD-VR	×	
	DVD-R*1	○	<ul style="list-style-type: none"> • MP3/ WMA/ AAC/ WAV/ FLAC/ Vorbis/ MPEG1/ MPEG2/ MPEG4/ H.264/ WMV/ MKV playback • Multi-border/Multisession playback (Playback depends on authoring conditions)
	DVD-RW	○	
	DVD+R	○	
	DVD+RW	○	
	DVD-R DL (Dual layer)	○	Only video format
DVD+R DL (Double layer)	○		
DVD-RAM	×		
CD	Music CD*1	○	
	CD-ROM	○	<ul style="list-style-type: none"> • MP3/ WMA/ AAC/ WAV/ FLAC/ Vorbis playback
	CD-R	○	<ul style="list-style-type: none"> • Multisession is supported.
	CD-RW	○	<ul style="list-style-type: none"> • Packet write is not supported.
	DTS-CD	×	
	Video CD (VCD)	○	
	Super video CD	×	
	Photo CD	×	
	CD-EXTRA	△	Only music CD session can be played.
	HDCD	△	Normal music CD sound quality
CCCD	×		
Others	Dualdisc	×	
	Super audio CD	△	Only CD layer can be played.

○ : Playback is possible.

△ : Playback is partly possible.

×

*1 Incompatible with 8 cm (3 inch) discs.

Use of DualDisc

When playing a "DualDisc" on this unit, the surface of the disc that is not played may be scratched while the disc is inserted or ejected. Since the music CD surface does not conform to the CD standard, playback may be impossible.

(A "DualDisc" is a disc with one surface containing DVD standard signals and the other surface containing music CD signals.)

About disc format

The disc format should be the one of the following.

- ISO 9660 Level 1/2
- Joliet
- Romeo
- Long file name

About files

The following audio, video, and picture files are supported.

Playable Audio files

	Format	Bit rate	Sampling frequency	Bit count
AAC-LC (.m4a)	MPEG2/4 AAC LC HE-AAC(V1,V2)	8 – 320kbps, VBR	16 – 48 kHz	16 bit
MP3 (.mp3)	MPEG 1/2 Audio Layer 3	8 – 320kbps, VBR	16 – 48 kHz	16 bit
WMA (.wma)	Windows Media Audio Standard L3 profile (Version 7,8,9)	8 – 320kbps	16 – 48 kHz	16 bit
Linear PCM (WAVE) (.wav)	RIFF waveform Audio Format	–	16 – 48 kHz (Disc), 16 – 192 kHz (USB/ SD)	16/ 24 bit
FLAC (.flac)	flac	–	16 – 48 kHz (Disc), 16 – 192 kHz (USB/ SD)	16/ 24 bit
Vorbis (.ogg)	vorbis	VBR	16 – 48 kHz	16 bit
DSD (.dsf, .dff)	DSF DSDIFF	–	2.8 MHz, 5.6 MHz, 11.2 MHz	1 bit

NOTE

- If music of normal CD and other playback systems are recorded in the same disc, only the playback system recorded at the first setout is played.
- WMA and AAC of which is covered with DRM cannot be played.
- DSD sound is converted to PCM sound before playback.
- The EmChinks tag of DSDIFF is not supported.
- Although the audio files are complied with the standards listed above, the play may be impossible depending on the types or conditions of media or device.

Acceptable Video files

	Profile	Max. Picture size	Max. bit rate	Audio format
MPEG-1 (.mpg, .mpeg)	–	352 × 240, 352 × 288	1.5 Mbps	MPEG Audio Layer 2
MPEG-2 (.mpg, .mpeg)	MP@ML	720 × 480, 720 × 576	8 Mbps	MPEG Audio Layer 2
H.264/MPEG-4 AVC (.mp4, .m4v, .avi, .flv, .f4v)	Baseline Profile, Main Profile	1920 × 1080 (30 fps)	8 Mbps	MP3, AAC
MPEG-4 (.mp4, .avi)	Advanced Simple Profile	1920 × 1080 (30 fps)	8 Mbps	MP3, AAC
WMV (.wmv)	Main Profile	1920 × 1080 (30 fps)	8 Mbps	WMA
MKV (.mkv)	Video Format follows H.264/MPEG-4 AVC, MPEG-4, WMV			MP3, AAC, WMA, Vorbis, FLAC

Limitation of structure for the file and the folder

	Disc media	USB device
Maximum number of folder layers	8	8
Maximum number of files (per folder)	999	999
Maximum number of folders (per folder)	5000	9999
Maximum number of folders (per device)	5000	–

NOTE

- You can enter a folder name and file name with 255 or fewer single-byte characters.
- Files in the folder whose folder name begins with a dot (.) cannot be played.

Region Codes in the World

The DVD players are given a region code according to the country or area it is marketed, as shown in the following map.

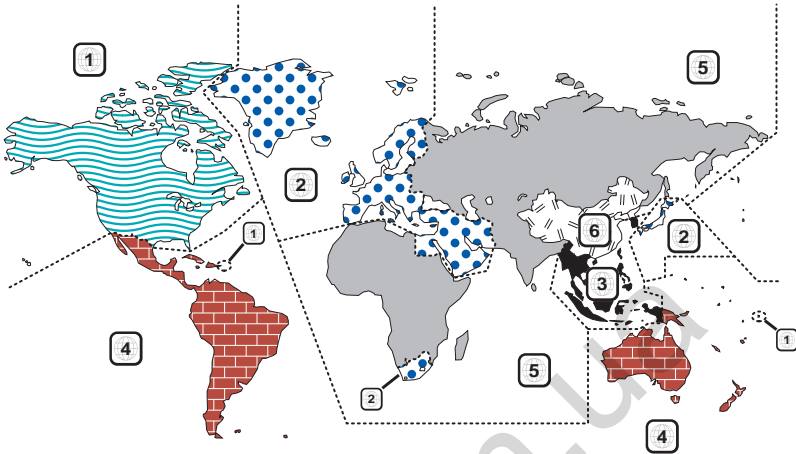

■ DVD disc marks



Indicates a region number. The discs with this mark can be played with any DVD player.



Indicates the number of audio languages recorded. Up to 8 languages can be recorded in a movie. You can select a favorite language.



Indicates the number of subtitled languages recorded. Up to 32 languages can be recorded.



If a DVD disc has scenes shot from multiple angles, you can select a favorite angle.



Indicates the type of screen for the image. The left mark indicates that a wide image picture (16:9) is displayed on a standard TV set screen (4:3) with a black band at both the top and bottom of the screen (letter box).

■ Operation regulatory marks

With this DVD, some functions of this unit such as the play function may be restricted depending on the location where the DVD is playing. In this case, the following marks will appear on the screen. For more information, refer to the disc manual.



■ Discs with limited period of use

Do not leave discs with a limited period of use in this unit. If you load an already expired disc, you may not be able to remove it from this unit.

DVD Language Codes

Code	Language
aa	Afar
ab	Abkhazian
af	Afrikaans
am	Amharic
ar	Arabic
as	Assamese
ay	Aymara
az	Azerbaijani
ba	Bashkir
be	Byelorussian
bg	Bulgarian
bh	Bihari
bi	Bislama
bn	Bengali, Bangla
bo	Tibetan
br	Breton
ca	Catalan
co	Corsican
cs	Czech
cy	Welsh
da	Danish
de	German
dz	Bhutani
el	Greek
en	English
eo	Esperanto
es	Spanish
et	Estonian
eu	Basque
fa	Persian
fi	Finnish
fj	Fiji
fo	Faroese
fr	French
fy	Frisian
ga	Irish
gd	Scots Gaelic
gl	Galician
gn	Guarani
gu	Gujarati
ha	Hausa
he	Hebrew
hi	Hindi
hr	Croatian
hu	Hungarian
hy	Armenian

Code	Language
ia	Interlingua
ie	Interlingue
ik	Inupiak
id	Indonesian
is	Icelandic
it	Italian
ja	Japanese
jv	Javanese
ka	Georgian
kk	Kazakh
kl	Greenlandic
km	Cambodian
kn	Kannada
ko	Korean
ks	Kashmiri
ku	Kurdish
ky	Kirghiz
la	Latin
lb	Luxembourgish
ln	Lingala
lo	Laotian
lt	Lithuanian
lv	Latvian, Lettish
mg	Malagasy
mi	Maori
mk	Macedonian
ml	Malayalam
mn	Mongolian
mo	Moldavian
mr	Marathi
ms	Malay
mt	Maltese
my	Burmese
na	Nauru
ne	Nepali
nl	Dutch
no	Norwegian
oc	Occitan
om	(Afan) Oromo
or	Oriya
pa	Punjabi
pl	Polish
ps	Pashto, Pushto
pt	Portuguese
qu	Quechua
rm	Rhaeto-Romance

Code	Language
rn	Kirundi
ro	Romanian
ru	Russian
rw	Kinyarwanda
sa	Sanskrit
sd	Sindhi
sg	Sangho
sh	Serbo-Croatian
si	Singhalese
sk	Slovak
sl	Slovenian
sm	Samoan
sn	Shona
so	Somali
sq	Albanian
sr	Serbian
ss	Siswati
st	Sesotho
su	Sundanese
sv	Swedish
sw	Swahili
ta	Tamil
te	Telugu
tg	Tajik
th	Thai
ti	Tigrinya
tk	Turkmen
tl	Tagalog
tn	Setswana
to	Tongan
tr	Turkish
ts	Tsonga
tt	Tatar
tw	Twi
uk	Ukrainian
ur	Urdu
uz	Uzbek
vi	Vietnamese
vo	Volapuk
wo	Wolof
xh	Xhosa
yo	Yoruba
zh	Chinese
zu	Zulu

Specifications

■ Monitor section

Picture Size

DNX8 DNX7

- : 6.95 inches (diagonal) wide
- : 156.6 mm (W) × 81.6 mm (H)

DNX5 DNX6

- : 6.2 inches (diagonal) wide
- : 137.5 mm (W) × 77.2 mm (H)

Display System

- : TN LCD panel

Drive System

- : TFT active matrix system

Number of Pixels

- : 1,152,000 (800H x 480V x RGB)

Effective Pixels

- : 99.99 %

Pixel Arrangement

- : RGB striped arrangement

Back Lighting

- : LED

■ DVD player section

D/A Converter

- : 24/ 32 bit

Audio Decoder

- : Linear PCM/ Dolby Digital/ MP3/ WMA/ AAC/ WAV/ FLAC/ Vorbis

Video Decoder

- : MPEG1/ MPEG2/ MPEG4/ WMV/ H.264/ MKV

Wow & Flutter

- : Below Measurable Limit

Frequency Response

- 96 kHz : 20 – 44,000 Hz
- 48 kHz : 20 – 22,000 Hz
- 44.1 kHz : 20 – 20,000 Hz

Total Harmonic Distortion

- : 0.010 % (1 kHz)

S/N Ratio (dB)

- : 90.5 dB

Dynamic Range

- : 89 dB

Disc Format

- : DVD-Video/ VIDEO-CD/ CD-DA

Quantifying Bit Number

- : 16/ 20/ 24 bit

■ USB interface section

USB Standard

- : USB 2.0 High Speed

File System

- : FAT 16/ 32, exFAT, NTFS

Maximum Power Supply Current

DNX8 DNX7 DNX5

- : DC 5 V $\overline{\text{max}}$ 1.5 A × 2

DNX6

- : DC 5 V $\overline{\text{max}}$ 1.5 A

D/A Converter

- : 24/ 32 bit

Audio Decoder

- : MP3/ WMA/ AAC/ WAV/ FLAC/ Vorbis/ DSD

Video Decoder

- : MPEG1/ MPEG2/ MPEG4/ WMV/ H.264/ MKV

■ SD (DNX8 DNX7 DNX5)

SD Standard

- : SD / SDHC / SDXC

Compatible File System

- : FAT 16/ 32, exFAT, NTFS

Capacity

- : Maximum 2T Byte

Data Transfer Rate

- : Maximum 24 Mbps

Audio Decoder

- : MP3/ WMA/ AAC/ WAV/ FLAC/ Vorbis/ DSD

Video Decoder

- : MPEG1/ MPEG2/ MPEG4/ WMV/ H.264/ MKV

■ HDMI/ MHL section

HDMI

- : Type-A

MHL Supported Version

- : MHL 2

MHL Maximum Power Supply Current

- : DC 5 V $\overline{\text{max}}$ 900 mA

Input Resolution

- VGA (640x480p @59.94Hz/60Hz)
- 480p (720x480p @59.94Hz/60Hz)
- 720p (1280x720p @59.94Hz/60Hz)

Input Audio Type

- : 32K/ 44.1K/ 48K/ 88.2K/ 96K/ 176.2K/ 192K Hz
- 16/20/24-bit Linear PCM

■ Bluetooth section

Technology

: Bluetooth Ver.3.0

Frequency

: 2.402 – 2.480 GHz

Output Power

: +4dBm (MAX), 0dBm (AVE), Power Class2

Maximum Communication range

: Line of sight approx. 10m (32.8 ft)

Audio Codec

: SBC/ AAC

Profile (Multi Profile support)

- HFP (V1.6) (Hands Free Profile)
- SPP (Serial Port Profile)
- A2DP (Advanced Audio Distribution Profile)
- AVRCP (V1.5) (Audio/Video Remote Control Profile)
- HID (Human Interface Device Profile)
- PBAP (Phonebook Access Profile)

■ DSP section

Graphics equalizer

Band: 13 Band

Frequency (BAND1 – 13)

: 62.5/ 100/ 160/ 250/ 400/ 630/ 1k/ 1.6k/ 2.5k/ 4k/
6.3k/ 10k/ 16k Hz

Gain

: -9/-8/-7/-6/-5/-4/-3/-2/-1/0/1/2/3/4/5/6/7/8/9 dB

2Way X'Over

High pass filter

Frequency: Through, 30/ 40/ 50/ 60/ 70/ 80/ 90/ 100/
120/ 150/ 180/ 220/ 250 Hz

Slope: -6/-12/-18/-24 dB/Oct.

Low pass filter

Frequency: 30/ 40/ 50/ 60/ 70/ 80/ 90/ 100/ 120/
150/ 180/ 220/ 250 Hz, Through

Slope: -6/-12/-18/-24 dB/Oct.

3Way X'Over

High pass filter

Frequency: 1k/ 1.6k/ 2.5k/ 4k/ 5k/ 6.3k/ 8k/ 10k/
12.5k Hz

Slope: -6/-12 dB/Oct.

Gain: -8/-7/-6/-5/-4/-3/-2/-1/ 0 dB

Band pass filter

Frequency: Through, 30/ 40/ 50/ 60/ 70/ 80/ 90/ 100/
120/ 150/ 180/ 220/ 250 Hz
1k/ 1.6k/ 2.5k/ 4k/ 5k/ 6.3k/ 8k/ 10k/ 12.5k
Hz, Through

Slope: -6/-12 dB/Oct.

Gain: -8/-7/-6/-5/-4/-3/-2/-1/ 0 dB

Low pass filter

Frequency: 30/ 40/ 50/ 60/ 70/ 80/ 90/ 100/ 120/
150/ 180/ 220/ 250 Hz, Through

Slope: -6/-12 dB/Oct.

Gain: -8/-7/-6/-5/-4/-3/-2/-1/ 0 dB

Position

Front / Rear /Subwoofer Delay

: 0 – 6.1 m (0.01 m Step)

Gain

: -8 – 0 dB

Subwoofer level

: -50 – +10 dB

■ DAB section (DAB3 DAB7 / DNX5170DABS/ DNX317DABS)

Frequency Range

L-BAND: 1452.960 – 1490.624 (MHz)

BAND III: 174.928 – 239.200 (MHz)

Sensitivity

: -100 dBm

S/N Ratio (dB)

: 90 dB

■ Digital Antenna Connector section (DAB3 DAB7 / DNX5170DABS/ DNX317DABS)

Connector type

: SMB

Output Voltage (11 – 16V)

: 14.4 V

Maximum Current

: < 100 mA

■ FM tuner section

Frequency Range (step)

: 87.5 MHz – 108.0 MHz (50 kHz)

Usable Sensitivity (S/N : 26 dB)

: 9.3 dBf (0.8 μ V/75 Ω)

Quieting Sensitivity (S/N : 46 dB)

: 15.2 dBf (1.6 μ V/75 Ω)

Frequency Response

: 30 Hz – 15 kHz

S/N Ratio (dB)

: 75 dB (MONO)

Selectivity (\pm 400 kHz)

: Over 80 dB

Stereo Separation

: 45 dB (1 kHz)

■ AM tuner section

Frequency Range (step)

LW: 153 – 279 kHz (9 kHz)

MW: 531 – 1611 kHz (9 kHz)

Usable Sensitivity

MW: 25 μ V

LW: 45 μ V

Appendix

■ Video section

Color System of External Video Input
: NTSC/PAL

External Video Input Level (mini jack)
: 1 Vp-p/ 75 Ω

External Audio Max Input Level (mini jack)
: 2 V/ 25 kΩ

Video Input Level (RCA jacks)
: 1 Vp-p/ 75 Ω

Video Output Level (RCA jacks)
: 1 Vp-p/ 75 Ω

Audio Output Level (mini jack)
: 1.2 V/ 10 kΩ

■ Audio section

Maximum Power (Front & Rear)
: 50 W × 4

Typical Power Output (Front & Rear)
Full Bandwidth Power (at less than 1% THD)
: 22 W × 4

Output frequency band
: 20 – 88,000 Hz

Preout Level (V)

DNX8

: 5 V/ 10 kΩ

DNX7 **DNX5**

: 4 V/ 10 kΩ

Preout Impedance

DNX8

: ≤ 300 Ω

DNX7 **DNX5**

: ≤ 600 Ω

Speaker Impedance

: 4 – 8 Ω

■ Navigation section

Receiver

: High-sensitivity GPS receiver

Reception Frequency

: 1575.42 MHz (C/A code)

Acquisition Times

Cold : 29 seconds (typ)
(All satellites at -130 dBm Without aiding)

Update Rate

: 1/second, continuous

Accuracy

Position: <2.5 meters, CEP, at -130 dBm
Velocity: 0.1 meter/sec

Position Method

: GPS

Antenna

: External GPS antenna

■ General

Operating Voltage

: 14.4 V (10.5 – 16 V allowable)

Maximum Current Consumption

: 15 A

Installation Dimensions (W × H × D)

DNX8 **DNX7**

: 182 × 112 × 163 mm

DNX5 **DNX3**

: 182 × 112 × 153 mm

Operational Temperature Range

: -10 °C – +60 °C

Weight

DNX8

: 2.7 kg

DNX7

: 2.5 kg

DNX5 **DNX3**

: 2.1 kg

NOTE

- Although the effective pixels for the liquid crystal panel is given as 99.99% or more, 0.01% of pixels may not light or may light incorrectly.

Specifications subject to change without notice.

About this Unit

■ Copyrights

- The Bluetooth® word mark and logos are registered trademarks owned by Bluetooth SIG, Inc. and any use of such marks by JVC KENWOOD Corporation is under license. Other trademarks and trade names are those of their respective owners.
- Manufactured under license from Dolby Laboratories. Dolby, Dolby Audio and the double-D symbol are trademarks of Dolby Laboratories.
-  is a trademark of DVD Format/Logo Licensing Corporation registered in the U.S., Japan and other countries.
- This item incorporates copy protection technology that is protected by U.S. patents and other intellectual property rights of Rovi Corporation. Reverse engineering and disassembly are prohibited.
- The "AAC" logo is a trademark of Dolby Laboratories.
- "Made for iPod" and "Made for iPhone" mean that an electronic accessory has been designed to connect specifically to iPod, or iPhone, respectively, and has been certified by the developer to meet Apple performance standards. Apple is not responsible for the operation of this device or its compliance with safety and regulatory standards. Please note that the use of this accessory with iPod, or iPhone may affect wireless performance.
- iPhone, iPod, iPod classic, iPod nano, and iPod touch are trademarks of Apple Inc., registered in the U.S. and other countries.
- Apple, Siri, Apple CarPlay and Apple CarPlay logo are trademarks of Apple Inc., registered in the U.S. and other countries.
- INRIX is a registered trademark of INRIX, Inc.
- SPOTIFY and the Spotify logo are among the registered trademarks of Spotify AB.
- Android, Android Auto, Google Play and other marks are trademarks of Google Inc.
- SDXC and microSDXC Logos are trademarks of SD-3C, LLC.
- The terms HDMI and HDMI High-Definition Multimedia Interface, and the HDMI logo are trademarks or registered trademarks of HDMI Licensing LLC in the United States and other countries.
- MHL and the MHL logo are a trademark or registered trademark of MHL, LLC.
 - Incorporates MHL 2
- THIS PRODUCT IS LICENSED UNDER THE AVC PATENT PORTFOLIO LICENSE FOR THE PERSONAL USE OF A CONSUMER OR OTHER USES IN WHICH IT DOES NOT RECEIVE REMUNERATION TO (i) ENCODE VIDEO IN COMPLIANCE WITH THE AVC STANDARD ("AVC VIDEO") AND/OR (ii) DECODE AVC VIDEO THAT WAS ENCODED BY A CONSUMER ENGAGED IN A PERSONAL ACTIVITY AND/OR WAS OBTAINED FROM A VIDEO PROVIDER LICENSED TO PROVIDE AVC VIDEO. NO LICENSE IS GRANTED OR SHALL BE IMPLIED FOR ANY OTHER USE. ADDITIONAL INFORMATION MAY BE OBTAINED FROM MPEG LA, L.L.C. SEE [HTTP://WWW.MPEGLA.COM](http://www.mpegla.com)
- THIS PRODUCT IS LICENSED UNDER THE MPEG-4 VISUAL PATENT PORTFOLIO LICENSE FOR THE PERSONAL AND NON-COMMERCIAL USE OF A CONSUMER FOR (i) ENCODING VIDEO IN COMPLIANCE WITH THE MPEG-4 VISUAL STANDARD ("MPEG-4 VIDEO") AND/OR (ii) DECODING MPEG-4 VIDEO THAT WAS ENCODED BY A CONSUMER ENGAGED IN A PERSONAL AND NON-COMMERCIAL ACTIVITY AND/OR WAS OBTAINED FROM A VIDEO PROVIDER LICENSED BY MPEG LA TO PROVIDE MPEG-4 VIDEO. NO LICENSE IS GRANTED OR SHALL BE IMPLIED FOR ANY OTHER USE. ADDITIONAL INFORMATION INCLUDING THAT RELATING TO PROMOTIONAL, INTERNAL AND COMMERCIAL USES AND LICENSING MAY BE OBTAINED FROM MPEG LA, L.L.C. SEE [HTTP://WWW.MPEGLA.COM](http://www.mpegla.com).
- THIS PRODUCT IS LICENSED UNDER THE VC-1 PATENT PORTFOLIO LICENSE FOR THE PERSONAL AND NON-COMMERCIAL USE OF A CONSUMER TO (i) ENCODE VIDEO IN COMPLIANCE WITH THE VC-1 STANDARD ("VC-1 VIDEO") AND/OR (ii) DECODE VC-1 VIDEO THAT WAS ENCODED BY A CONSUMER ENGAGED IN A PERSONAL AND NON-COMMERCIAL ACTIVITY AND/OR WAS OBTAINED FROM A VIDEO PROVIDER LICENSED TO PROVIDE VC-1 VIDEO. NO LICENSE IS GRANTED OR SHALL BE IMPLIED FOR ANY OTHER USE. ADDITIONAL INFORMATION MAY BE OBTAINED FROM MPEG LA, L.L.C. SEE [HTTP://WWW.MPEGLA.COM](http://www.mpegla.com)

Appendix

- libFLAC

Copyright (C) 2000,2001,2002,2003,2004,2005,2006,2007,2008,2009 Josh Coalson

Redistribution and use in source and binary forms, with or without modification, are permitted provided that the following conditions are met:

- Redistributions of source code must retain the above copyright notice, this list of conditions and the following disclaimer.
- Redistributions in binary form must reproduce the above copyright notice, this list of conditions and the following disclaimer in the documentation and/or other materials provided with the distribution.
- Neither the name of the Xiph.org Foundation nor the names of its contributors may be used to endorse or promote products derived from this software without specific prior written permission.

THIS SOFTWARE IS PROVIDED BY THE COPYRIGHT HOLDERS AND CONTRIBUTORS "AS IS" AND ANY EXPRESS OR IMPLIED WARRANTIES, INCLUDING, BUT NOT LIMITED TO, THE IMPLIED WARRANTIES OF MERCHANTABILITY AND FITNESS FOR A PARTICULAR PURPOSE ARE DISCLAIMED. IN NO EVENT SHALL THE FOUNDATION OR CONTRIBUTORS BE LIABLE FOR ANY DIRECT, INDIRECT, INCIDENTAL, SPECIAL, EXEMPLARY, OR CONSEQUENTIAL DAMAGES (INCLUDING, BUT NOT LIMITED TO, PROCUREMENT OF SUBSTITUTE GOODS OR SERVICES; LOSS OF USE, DATA, OR PROFITS; OR BUSINESS INTERRUPTION) HOWEVER CAUSED AND ON ANY THEORY OF LIABILITY, WHETHER IN CONTRACT, STRICT LIABILITY, OR TORT (INCLUDING NEGLIGENCE OR OTHERWISE) ARISING IN ANY WAY OUT OF THE USE OF THIS SOFTWARE, EVEN IF ADVISED OF THE POSSIBILITY OF SUCH DAMAGE.

- libvorbis

Copyright (c) 2002-2008 Xiph.org Foundation

Redistribution and use in source and binary forms, with or without modification, are permitted provided that the following conditions are met:

- Redistributions of source code must retain the above copyright notice, this list of conditions and the following disclaimer.
- Redistributions in binary form must reproduce the above copyright notice, this list of conditions and the following disclaimer in the documentation and/or other materials provided with the distribution.
- Neither the name of the Xiph.org Foundation nor the names of its contributors may be used to endorse or promote products derived from this software without specific prior written permission.

THIS SOFTWARE IS PROVIDED BY THE COPYRIGHT HOLDERS AND CONTRIBUTORS "AS IS" AND ANY EXPRESS OR IMPLIED WARRANTIES, INCLUDING, BUT NOT LIMITED TO, THE IMPLIED WARRANTIES OF MERCHANTABILITY AND FITNESS FOR A PARTICULAR PURPOSE ARE DISCLAIMED. IN NO EVENT SHALL THE FOUNDATION OR CONTRIBUTORS BE LIABLE FOR ANY

DIRECT, INDIRECT, INCIDENTAL, SPECIAL, EXEMPLARY, OR CONSEQUENTIAL DAMAGES (INCLUDING, BUT NOT LIMITED TO, PROCUREMENT OF SUBSTITUTE GOODS OR SERVICES; LOSS OF USE, DATA, OR PROFITS; OR BUSINESS INTERRUPTION) HOWEVER CAUSED AND ON ANY THEORY OF LIABILITY, WHETHER IN CONTRACT, STRICT LIABILITY, OR TORT (INCLUDING NEGLIGENCE OR OTHERWISE) ARISING IN ANY WAY OUT OF THE USE OF THIS SOFTWARE, EVEN IF ADVISED OF THE POSSIBILITY OF SUCH DAMAGE.

- libogg

Copyright (c) 2002, Xiph.org Foundation

Redistribution and use in source and binary forms, with or without modification, are permitted provided that the following conditions are met:

- Redistributions of source code must retain the above copyright notice, this list of conditions and the following disclaimer.
- Redistributions in binary form must reproduce the above copyright notice, this list of conditions and the following disclaimer in the documentation and/or other materials provided with the distribution.
- Neither the name of the Xiph.org Foundation nor the names of its contributors may be used to endorse or promote products derived from this software without specific prior written permission.

THIS SOFTWARE IS PROVIDED BY THE COPYRIGHT HOLDERS AND CONTRIBUTORS "AS IS" AND ANY EXPRESS OR IMPLIED WARRANTIES, INCLUDING, BUT NOT LIMITED TO, THE IMPLIED WARRANTIES OF MERCHANTABILITY AND FITNESS FOR A PARTICULAR PURPOSE ARE DISCLAIMED. IN NO EVENT SHALL THE FOUNDATION OR CONTRIBUTORS BE LIABLE FOR ANY DIRECT, INDIRECT, INCIDENTAL, SPECIAL, EXEMPLARY, OR CONSEQUENTIAL DAMAGES (INCLUDING, BUT NOT LIMITED TO, PROCUREMENT OF SUBSTITUTE GOODS OR SERVICES; LOSS OF USE, DATA, OR PROFITS; OR BUSINESS INTERRUPTION) HOWEVER CAUSED AND ON ANY THEORY OF LIABILITY, WHETHER IN CONTRACT, STRICT LIABILITY, OR TORT (INCLUDING NEGLIGENCE OR OTHERWISE) ARISING IN ANY WAY OUT OF THE USE OF THIS SOFTWARE, EVEN IF ADVISED OF THE POSSIBILITY OF SUCH DAMAGE.

■ The marking of products using lasers

**CLASS 1
LASER PRODUCT**

The label is attached to the chassis/case and says that the component uses laser beams that have been classified as Class 1. It means that the unit is utilizing laser beams that are of a weaker class. There is no danger of hazardous radiation outside the unit.

■ Information on Disposal of Old Electrical and Electronic Equipment and Batteries (applicable for EU countries that have adopted separate waste collection systems)

Products and batteries with the symbol (crossed-out wheeled bin) cannot be disposed as household waste.

Old electrical and electronic equipment and batteries should be recycled at a facility capable of handling these items and their waste byproducts.

Contact your local authority for details in locating a recycle facility nearest to you.

Proper recycling and waste disposal will help conserve resources whilst preventing detrimental effects on our health and the environment.

Notice: The sign "Pb" below the symbol for batteries indicates that this battery contains lead.



■ מידע בדבר השלכה לאשפה של ציוד חשמלי ואלקטרוני ישן וכן סוללות (רלוונטי למדינות שמשמשות במערכת איסוף אשפה מופרדת).

לא ניתן להשליך מוצרים וסוללות עם הסיומן (פח אשפה עם X עליו) כאשפה ביתית רגילה.

יש למחזר ציוד חשמלי ואלקטרוני ישן וכן סוללות במתקן המסוגל לטפל בפריטים כאלה ובתוצרי הלואי שלהם.

צרו קשר עם הרשות המקומית לקבלת פריטים אודות מתקן המיחזור הקרוב אליכם. מחזור והשלכה לאשפה נאותים יעזרו לשמר משאבים ולמנוע הנשפעות שליליות על בריאותנו ועל הסביבה.

שימו לב: הסיומן Pb שמתחת לסיומן עובר סוללות מציינ שהסוללה מכילה עופרת.



Declaration of Conformity with regard to the RE Directive 2014/53/EU

Declaration of Conformity with regard to the RoHS Directive 2011/65/EU

Manufacturer:

JVC KENWOOD Corporation
3-12, Moriyacho, Kanagawa-ku, Yokohama-shi,
Kanagawa 221-0022, JAPAN

EU Representative:

JVCKENWOOD NEDERLAND B.V.
Amsterdamseweg 37, 1422 AC UITHOORN, The
Netherlands

English

Hereby, JVC KENWOOD declares that the radio equipment DNX8170DABS/ DNX7170DABS/ DNX5170DABS/ DNXS170BTS/ DNX317DABS/ DNX317BTS is in compliance with Directive 2014/53/EU. The full text of the EU declaration of conformity is available at the following internet address:

Français

Par la présente, JVC KENWOOD déclare que l'équipement radio DNX8170DABS/ DNX7170DABS/ DNX5170DABS/ DNXS170BTS/ DNX317DABS/ DNX317BTS est conforme à la directive 2014/53/UE. L'intégralité de la déclaration de conformité UE est disponible à l'adresse Internet suivante :

Deutsch

Hiertmit erklärt JVC KENWOOD, dass das Funkgerät DNX8170DABS/ DNX7170DABS/ DNX5170DABS/ DNXS170BTS/ DNX317DABS/ DNX317BTS der Richtlinie 2014/53/EU entspricht. Der volle Text der EU-Konformitätserklärung steht unter der folgenden Internetadresse zur Verfügung:

Nederlands

Hierbij verklaart JVC KENWOOD dat de radioapparatuur DNX8170DABS/ DNX7170DABS/ DNX5170DABS/ DNXS170BTS/ DNX317DABS/ DNX317BTS in overeenstemming is met Richtlijn 2014/53/EU. De volledige tekst van de EU-verklaring van overeenstemming is te vinden op het volgende internetadres:

Italiano

Con la presente, JVC KENWOOD dichiara che l'apparecchio radio DNX8170DABS/ DNX7170DABS/ DNX5170DABS/ DNXS170BTS/ DNX317DABS/ DNX317BTS è conforme alla Direttiva 2014/53/UE. Il testo integrale della dichiarazione di conformità UE è disponibile al seguente indirizzo internet:

Español

Por la presente, JVC KENWOOD declara que el equipo de radio DNX8170DABS/ DNX7170DABS/ DNX5170DABS/ DNXS170BTS/ DNX317DABS/ DNX317BTS cumple la Directiva 2014/53/UE. El texto completo de la declaración de conformidad con la UE está disponible en la siguiente dirección de internet:

Português

Deste modo, a JVC KENWOOD declara que o equipamento de rádio DNX8170DABS/ DNX7170DABS/ DNX5170DABS/ DNXS170BTS/ DNX317DABS/ DNX317BTS está em conformidade com a Diretiva 2014/53/UE. O texto integral da declaração de conformidade da UE está disponível no seguinte endereço de internet:

Appendix

Polska

Niniejszym, JVC KENWOOD deklaruje, że sprzęt radiowy DNX8170DABS/ DNX7170DABS/ DNX5170DABS/ DNX3170DABS/ DNX317BTS jest zgodny z dyrektywą 2014/53/UE. Pełny tekst deklaracji zgodności EU jest dostępny pod adresem:

Česky

Společnost JVC KENWOOD tímto prohlašuje, že rádiové zařízení DNX8170DABS/ DNX7170DABS/ DNX5170DABS/ DNX3170DABS/ DNX317BTS splňuje podmínky směrnice 2014/53/EU. Plný text EU prohlášení o shodě je dostupný na následující internetové adrese:

Magyar

JVC KENWOOD ezennel kijelenti, hogy a DNX8170DABS/ DNX7170DABS/ DNX5170DABS/ DNX3170DABS/ DNX317BTS rádióberendezés megfelel a 2014/53/EU irányelvnek. Az EU konformitási nyilatkozat teljes szövege az alábbi weboldalon érhető el:

Hrvatski

JVC KENWOOD ovim izjavlja da je radio oprema DNX8170DABS/ DNX7170DABS/ DNX5170DABS/ DNX3170DABS/ DNX317BTS u skladu s Direktivom 2014/53/EU. Cjeloviti tekst deklaracije Europske unije o usklađenosti dostupan je na sljedećoj internet adresi:

Svenska

Härmed försäkras JVC KENWOOD att radioustrustningen DNX8170DABS/ DNX7170DABS/ DNX5170DABS/ DNX3170DABS/ DNX317BTS är i enlighet med direktiv 2014/53/UE. Den fullständiga texten av EU-försäkran om överensstämmelse finns på följande Internetadress :

Suomi

JVC KENWOOD julistaa täten, että radiolaitte DNX8170DABS/ DNX7170DABS/ DNX5170DABS/ DNX3170DABS/ DNX317BTS on direktiivin 2014/53/EU mukainen. EU-vaatimustenmukaisuusvaakuttus löytyy kokonaisuudessaan seuraavasta internet-osoitteesta:

Slovensko

S tem JVC KENWOOD izjavlja, da je radijska oprema DNX8170DABS/ DNX7170DABS/ DNX5170DABS/ DNX3170DABS/ DNX317BTS v skladu z Direktivo 2014/53/UE. Celotno besedilo direktive EU o skladnosti je dostopno na tem spletnem naslovu:

Slovensky

Spoločnosť JVC KENWOOD týmto vyhlasuje, že rádiové zariadenie DNX8170DABS/ DNX7170DABS/ DNX5170DABS/ DNX3170DABS/ DNX317BTS vyhovuje smernici 2014/53/UE. Celý text EÚ vyhlásenia o zhode nájdete na nasledovnej internetovej adrese:

Dansk

Herved erklærer JVC KENWOOD, at radioudstyret DNX8170DABS/ DNX7170DABS/ DNX5170DABS/ DNX3170DABS/ DNX317BTS er i overensstemmelse med Direktiv 2014/53/UE. EU-overensstemmelseserklæringens fulde ordlyd er tilgængelig på følgende internetadresse:

Norsk

JVC KENWOOD erklærer herved at radioustyret DNX8170DABS/ DNX7170DABS/ DNX5170DABS/ DNX3170DABS/ DNX317BTS er i samsvar med Direktiv 2014/53/UE. Den fullstendige teksten til EU-konformitetserklæringen er tilgjengelig på følgende internetadresse:

Ελληνικά

Με το παρόν, η JVC KENWOOD δηλώνει ότι ο ραδιοεξοπλισμός DNX8170DABS/ DNX7170DABS/ DNX5170DABS/ DNX3170DABS/ DNX317BTS συμμορφώνεται με την Οδηγία 2014/53/ΕΕ. Το πλήρες κείμενο της δήλωσης συμμόρφωσης της ΕΕ είναι διαθέσιμο στην ακόλουθη διεύθυνση στο διαδίκτυο:

Eesti

Käesolevaga JVC KENWOOD kinnitab, et DNX8170DABS/ DNX7170DABS/ DNX5170DABS/ DNX3170DABS/ DNX317BTS raadiovarustus on vastavuses direktiiviga 2014/53/EL. ELi vastavusdeklaratsiooni terviktekst on kättesaadav järgmisel internetiaadressil:

Latviešu

JVC KENWOOD ar šo deklarē, ka radio aparatūra DNX8170DABS/ DNX7170DABS/ DNX5170DABS/ DNX3170DABS/ DNX317BTS atbilst direktīvas 2014/53/ES prasībām. Pilns ES atbilstības deklarācijas teksts ir pieejams šādā tīmekļa adresē:

Lietuviškai

Šiuo JVC KENWOOD pažymi, kad radijo įranga DNX8170DABS/ DNX7170DABS/ DNX5170DABS/ DNX3170DABS/ DNX317BTS atitinka 2014/53/EB direktyvos reikalavimus. Visą EB direktyvos atitikties deklaracijos tekstą galite rasti šiuo internetiniu adresu:

Malti

B'dan, JVC KENWOOD jiddikjara li t-taġmir tar-radju DNX8170DABS/ DNX7170DABS/ DNX5170DABS/ DNX3170DABS/ DNX317BTS huwa konformi mad-Direttiva 2014/53/UE. It-test kollu tad-dikjarazzjoni ta' konformita huwa disponibbli fl-indirizz intranet li ġej:

Українська

Таким чином, компанія JVC KENWOOD заявляє, що радіообладнання DNX8170DABS/ DNX7170DABS/ DNX5170DABS/ DNX3170DABS/ DNX317BTS відповідає Директиві 2014/53/UE. Повний текст декларації про відповідність ЄС можна знайти в Інтернеті за такою адресою:

Türkçe

Burada, JVC KENWOOD DNX8170DABS/ DNX7170DABS/ DNX5170DABS/ DNX3170DABS/ DNX317BTS radyo ekipmanının 2014/53/AB Direktifine uygun olduğunu bildirir. AB uyumluluk deklarasyonunun tam metni aşağıdaki internet adresinde mevcuttur.

Русский

JVC KENWOOD настоящим заявляет, что радиооборудование DNX8170DABS/ DNX7170DABS/ DNX5170DABS/ DNX3170DABS/ DNX317BTS соответствует Директиве 2014/53/UE. Полный текст декларации соответствия ЕС доступен по следующему адресу в сети Интернет:

Limba română

Prin prezenta, JVC KENWOOD declară că echipamentul radio DNX8170DABS/ DNX7170DABS/ DNX5170DABS/ DNX3170DABS/ DNX317BTS este în conformitate cu Directiva 2014/53/UE. Textul integral al declarației de conformitate UE este disponibil la următoarea adresă de internet:

Български език

С настоящото JVC KENWOOD декларира, че радиооборудването на DNX8170DABS/ DNX7170DABS/ DNX5170DABS/ DNX3170DABS/ DNX317BTS е в съответствие с Директива 2014/53/ЕС. Пълният текст на ЕС декларацията за съответствие е достъпен на следния интернет адрес:

URL: <http://www.kenwood.com/cs/ce/eudoc/>

130.com.ua

Remote control

This unit can be operated using the remote control KNA-RCDV331 (optional accessory).

⚠ CAUTION

- Put the remote control in a place where it will not move during braking or other operations. A dangerous situation could result, if the remote control falls down and gets wedged under the pedals while driving.
- Do not leave the battery near fire or under direct sunlight. A fire, explosion or excessive heat generation may result.
- Do not recharge, short, break up or heat the battery or place it in an open fire. Such actions may cause the battery to leak fluid. If spilled fluid comes in contact with your eyes or on clothing, immediately rinse with water and consult a physician.
- Place the battery out of reach of children. In the unlikely event that a child swallows the battery, immediately consult a physician.

Battery Installation

If the remote control operates only over shorter distances or does not operate at all, it is possible that the batteries are depleted. In such instances, replace the both batteries with new ones.

- 1** Insert two “AAA”/“R03”-size batteries with the ⊕ and ⊖ poles aligned properly, following the illustration inside the case.

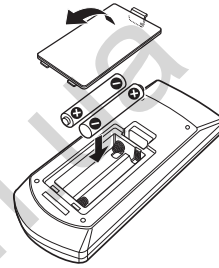

Functions of the Remote control Buttons

Switch the operation mode

The functions operated from the remote control differ depending on the position of the mode switch.

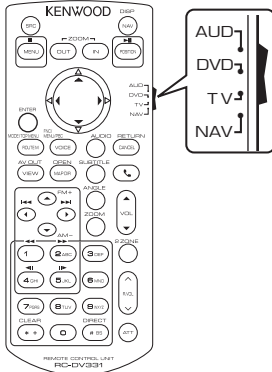

■ AUD mode

Switch to this mode when controlling a selected source or tuner source, etc.

■ DVD mode

Switch to this mode when playing a disc media including DVD, VCD, and CD.

■ NAV mode

Switch to this mode when controlling navigation function.

■ TV mode

Not used.

NOTE

- When controlling a player that is not integrated in the unit, select "AUD" mode.

Direct search mode

Using the remote control, you can jump directly to the desired file, track chapter, etc. with entering the number corresponding to the content.

NOTE

- This operation cannot be performed for USB device and iPod.

1 Press the #BS button several times until the desired content appears.

The available contents are different depending on the source.

■ DVD

Title number/Chapter number

■ VCD 1.X and 2.X (PBC OFF)

Track number

■ VCD 2.X (PBC ON)

Scene number/Track number

■ Music CD

Track number

■ Radio

Frequency value

2 Enter the number of the content you want to play using the numeric keypad.

3 For DVD or VCD, music CD, press the ENTER button.

For radio, press the ◀ or ▶ button.

> The content you entered is played.

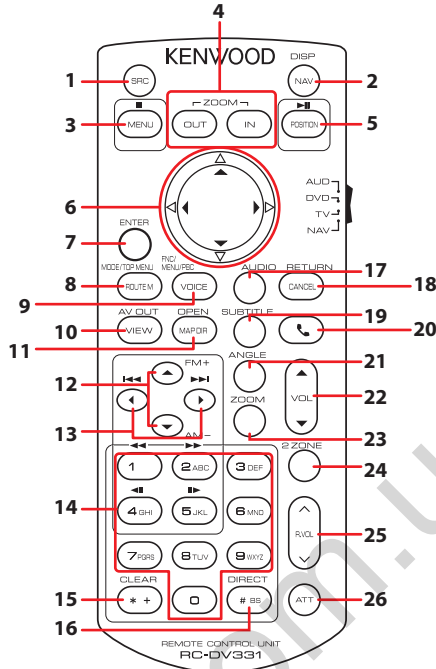

	Key Name	Mode switch	Function
1	SRC	AUD	Switches to the source to be played. In hands-free mode, hangs up the phone.
2	NAV	-	Switches between the navigation and the source screens.
3	MENU	DVD	Stops playing and memorizes the last point where the disc stopped. The last point is deleted by pressing twice.
		NAV	Displays Main menu.
4	OUT, IN	NAV	Zooms in or out the navigation map.
5	POSITION	AUD, DVD	Pauses the track or file, and resumes playing by pressing twice. During radio source in AUD mode, switches the seek mode.
		NAV	Displays the current position.
6	Cursor Key	DVD	Moves the cursor in the DVD menu.
		NAV	Moves the cursor or scrolls the map.
7	ENTER	AUD, DVD	Performs the selected function.
		NAV	<ul style="list-style-type: none"> Registers the selected position. Performs the selected function.
8	ROUTE M	AUD	Screen mode changes each time you press this key during video playback.
		DVD	Returns to the DVD top menu.
		NAV	Displays Route Option menu.

	Key Name	Mode switch	Function
9	VOICE	AUD	Displays the control screen of current source. (USB, SD, iPod, DISC)
		DVD	Displays the DVD menu. Turns the playback control on or off while playing VCD.
		NAV	Speaks the voice guidance.
10	VIEW	AUD, DVD	Switches the AV source to be output.
		NAV	Switches between 2D and 3D map displays.
11	MAP DIR	AUD, DVD	Switches the display angle each time it is pressed.
		NAV	Switches between the heading up navigation and north up navigation map displays.
12	▲/▼	AUD, DVD	Selects the folder to be played. During radio source in AUD mode, select FM/ AM band to be received.
13	◀▶	AUD, DVD	Selects the track or file to be played. During radio source in AUD mode, switches to broadcast stations received by the unit.
14	Numeric Keypad	AUD	Specifies the number to search in direct search. For details on the direct search mode, see Direct search mode (P.99) .
		DVD	<ul style="list-style-type: none"> • Press 1 2 to fast forward/backward. • Press 4 5 to slow forward/backward. Switches the slow playback speed each time you press this key.* *DVD only
15	* +	DVD	Clears the number.
16	# BS	AUD, DVD	Switches to the direct search mode. For details on the direct search mode, see Direct search mode (P.99) .
17	AUDIO	DVD	Switches the voice language each time you press this key.
18	CANCEL	DVD	Displays previous screen.
		NAV	Cancels the operations.
19	SUBTITLE	DVD	Switches the subtitle language.
20		–	When a call comes in, answers the call.
21	ANGLE	DVD	Switches the picture angle each time you press this key.
22	Vol ▲▼	–	Adjusts the volume.
23	ZOOM	DVD	Switches the zoom ratio (2, 3, 4, Off) each time you press this key.
24	2 ZONE	AUD, DVD	Switches the Dual Zone function on and off.
25	R.VOL ^▼	–	Adjusts volume at rear when the Dual Zone function is on.
26	ATT	–	Lowers the volume by pressing the key once. Restores the previous volume by pressing the key twice.