



PHONES

(044) 338-0-130
(050) 332-0-130
(063) 577-0-130
(067) 353-0-130

130
COM.UA

Internet store of
autogoods



SKYPE
km-130

CAR RECEIVERS — Receivers • Media receivers and stations • Native receivers • CD/DVD changers • FM-modulators/USB adapters • Flash memory • Facia plates and adapters • Antennas • Accessories |
CAR AUDIO — Car audio speakers • Amplifiers • Subwoofers • Processors • Crossovers • Headphones • Accessories | TRIP COMPUTERS — Universal computers • Model computers • Accessories |
GPS NAVIGATORS — Portable GPS • Built-in GPS • GPS modules • GPS trackers • Antennas for GPS navigators • Accessories | VIDEO — DVR • TV sets and monitors • Car TV tuners • Cameras • Videomodules
• Transcoders • Car TV antennas • Accessories | SECURITY SYSTEMS — Car alarms • Bike alarms • Mechanical blockers • Immobilizers • Sensors • Accessories | OPTIC AND LIGHT — Xenon • Bixenon • Lamps
• LED • Stroboscopes • Optic and Headlights • Washers • Light, rain sensors • Accessories | PARKTRONICS AND MIRRORS — Rear parktronic • Front parktronic • Combined parktronic • Rear-view mirrors
• Accessories | HEATING AND COOLING — Seat heaters • Mirrors heaters • Screen-wipers heaters • Engine heaters • Auto-refrigerators • Air conditioning units • Accessories | TUNING — Vibro-isolation
• Noise-isolation • Tint films • Accessories | ACCESSORIES — Radar-detectors • Handsfree, Bluetooth • Windowlifters • Compressors • Measuring instruments • Cleaners • Carsits
• Miscellaneous | MOUNTING — Installation kits • Upholstery • Grilles • Tubes • Cable and wire • Tools • Miscellaneous | POWER — Batteries • Converters • Start-charging equipment • Capacitors
• Accessories | MARINE AUDIO AND ELECTRONICS — Marine receivers • Marine audio speakers • Marine subwoofers • Marine amplifiers • Accessories | CAR CARE PRODUCTS — Additives • Washer fluid •
Care accessories • Car polish • Flavors • Adhesives and sealants | LIQUID AND OIL — Motor oil • Transmission oil • Brake fluid • Antifreeze • Technical lubricant



In store "130" you can find and buy almost all necessary goods for your auto in Kyiv and other cities, delivery by ground and postal services. Our experienced consultants will provide you with exhaustive information and help you to chose the very particular thing. We are waiting for you at the address

<http://130.com.ua>

KENWOOD

DDX9716BTS DDX9716BTSR DDX8016DABS

MONITOR WITH DVD RECEIVER
INSTRUCTION MANUAL

JVCKENWOOD Corporation



CONTENTS

BEFORE USE	2	BLUETOOTH	40
INITIAL SETTINGS	4	SETTINGS	51
Initial setup.....	4	Settings for using applications of iPod/iPhone/ Android/BlackBerry	51
Setting the security function	4	Selecting different sources for the front and rear monitors—Zone Control.....	52
Calendar/clock settings	6	Sound adjustment—Audio	53
BASICS	7	Adjustment for video playback.....	58
Component names and functions	7	Changing the display design.....	59
Common operations.....	8	Customizing the system settings	61
Common screen operations.....	9	Setting menu items—SETUP	62
Selecting the playback source/option	12	REMOTE CONTROLLER	65
Using the pop-up short-cut menu.....	13	CONNECTION/INSTALLATION	68
DISCS	14	REFERENCES	75
USB	18	Maintenance	75
iPod/iPhone	21	More information.....	75
APPS—Android Auto™/Apple CarPlay	24	Error message list.....	79
Radio	27	Troubleshooting.....	79
DIGITAL RADIO (DAB)	31	Specifications.....	82
OTHER EXTERNAL COMPONENTS	36		
Using a camera.....	36		
Using external audio/video players—AV-IN	37		
Watching a TV.....	38		

BEFORE USE

IMPORTANT

To ensure proper use, please read through this manual before using this product. It is especially important that you read and observe WARNINGS and CAUTIONS in this manual. Please keep the manual in a safe and accessible place for future reference.

⚠ **WARNINGS: (To prevent accidents and damage)**

- DO NOT install any unit or wire any cable in a location where;
 - it may obstruct the steering wheel and gearshift lever operations.
 - it may obstruct the operation of safety devices such as air bags.
 - it may obstruct visibility.
- DO NOT operate the unit while driving. If you need to operate the unit while driving, be sure to look around carefully.
- The driver must not watch the monitor while driving.

How to read this manual:

- Illustrations of DDX9716BTS are mainly used for explanation. The displays and panels shown in this manual are examples used to provide clear explanations of the operations. For this reason, they may be different from the actual displays or panels.
- This manual mainly explains operations using the buttons on the monitor panel and touch panel. For operations using the remote controller (KNA-RCDV331: separately purchased), see page 65.
- < > indicates the various screens/menus/settings that appear on the touch panel.
- [] indicates the buttons/selectable items on the touch panel.
- **Indication language:** English indications are used for the purpose of explanation. You can select the indication language from the <SETUP> menu. (Page 63)
- Updated information (the latest Instruction Manual, system updates, new functions, etc.) is available from <<http://www.kenwood.com/cs/ce/>>.

BEFORE USE

The marking of products using lasers



The label is attached to the chassis/case and says that the component uses laser beams that have been classified as Class 1. It means that the unit is utilizing laser beams that are of a weaker class. There is no danger of hazardous radiation outside the unit.



Information on Disposal of Old Electrical and Electronic Equipment and Batteries (applicable for countries that have adopted separate waste collection systems)

Products and batteries with the symbol (crossed-out wheeled bin) cannot be disposed as household waste.

Old electrical and electronic equipment and batteries should be recycled at a facility capable of handling these items and their waste by products. Contact your local authority for details in locating a recycle facility nearest to you.

Proper recycling and waste disposal will help conserve resources whilst preventing detrimental effects on our health and the environment.

Notice: The sign "Pb" below the symbol for batteries indicates that this battery contains lead.

For Israel

מידע בדבר השלכה לאשפה של ציוד חשמלי ואלקטרוני יש וכן סוללות (רלונטי למדינות שמשמשות במערכת איסוף אשפה מופרדת). לא ניתן להשליך מוצרים וסוללות עם הסימון (פח אשפה עם X עליו) כאשפה ביתית רגילה. יש למחזר ציוד חשמלי ואלקטרוני יש וכן סוללות במתקן המסוגל לטפל בפריטים כאלה ובתוצרי הלואי שלהם. צרו קשר עם הרשות המקומית לקבלת פרטים אודות מתקן המיחזור הקרוב אליכם. מיחזור והשלכה לאשפה נאותים יעזרו לשמר משאבים ולמנוע השפעות שליליות על בריאותנו ועל הסביבה. שימו לב: הסימון Pb שמתחת לסימון עבור סוללות מציינ שהסוללה מכילה עופרת.

⚠ Cautions on the monitor:

- The monitor built into this unit has been produced with high precision, but it may have some ineffective dots. This is inevitable and is not considered defective.
- Do not expose the monitor to direct sunlight.
- Do not operate the touch panel using a ball-point pen or similar tool with a sharp tip. Touch the buttons on the touch panel with your finger directly (if you are wearing a glove, take it off).
- When the temperature is very cold or very hot...
 - Chemical changes occur inside, causing malfunction.
 - Pictures may not appear clearly or may move slowly. Pictures may not be synchronized with the sound or picture quality may decline in such environments.

For safety...

- Do not raise the volume level too much, as this will make driving dangerous by blocking outside sounds, and may cause hearing loss.
- Stop the car before performing any complicated operations.

Temperature inside the car...

If you have parked the car for a long time in hot or cold weather, wait until the temperature in the car becomes normal before operating the unit.

INITIAL SETTINGS

Initial setup

When you power on the unit for the first time, the initial setting screen appears.

- You can also change the settings on the <SETUP> screen. (Page 62)

1 Perform the initial settings.

Touch the desired item to configure the setting.

- You can scroll the screen by touching [▲]/[▼] to show more items.
- If another setting screen is displayed, set the item, then touch [↶] to return to previous screen.



[Language] Select the text language used for on-screen information. (Page 63)

- Touch **[Language Select]**, then select the desired language.

[Clock] Adjust the calendar/clock. (Page 6)

[Colour] Select the color of the buttons on the monitor panel. (Page 59)

- Touch **[Panel Colour]**, then select the desired color.

[Camera] Configure settings for the connected camera. (Page 36)

[DEMO] Activate ([ON]) or deactivate ([OFF]) the display demonstration. (Page 64)

2 Finish the procedure.

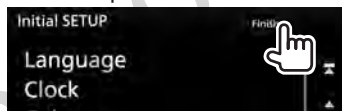

The Home screen is displayed.

Setting the security function

□ Registering the security code

You can set a security code to protect your receiver system against theft.

- 1 Display the source/option selection screen. On the Home screen or the source control screen:



- 2 Display the <SETUP> screen.

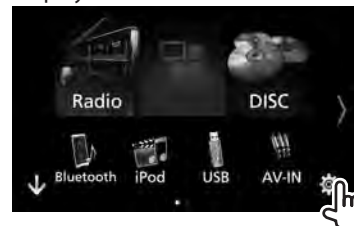

INITIAL SETTINGS

- 3 Display the <Security> screen.

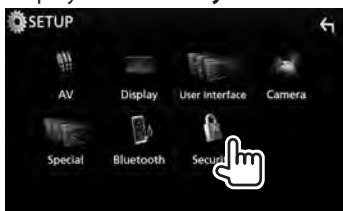

- 4 Display the <Security Code Set> screen.

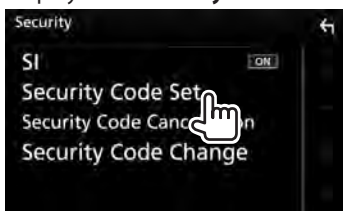

- 5 Enter a four-digit number (①), then confirm the entry (②).



- Touch [↩] to delete the last entry.

- 6 Repeat step 5 to confirm your security code.

Now, your security code is registered.

- To return to the Home screen, press HOME on the monitor panel, or touch [↩] to return to the previous screen.
- When the unit is disconnected from the battery, you are required to enter the security code. Enter the correct security code, then confirm the entry.

To change the security code: Touch [Security Code Change] on the <Security> screen, then repeat steps 5 and 6.

To clear the security code: Touch [Security Code Cancellation] on the <Security> screen.

❑ Activating the security function

You can activate the security function to protect your receiver system against theft.

- 1 Display the <Security> screen. (Page 4)
- 2 Activate the security function. Each time you touch [SI], the function is activated ([ON]) or deactivated ([OFF]).

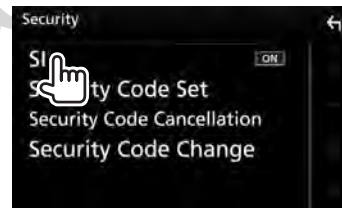

The security indicator on the monitor panel flashes when the vehicle ignition is off.

- To return to the Home screen, press HOME on the monitor panel, or touch [↩] to return to the previous screen.

To deactivate the security function: Touch [SI] to select [OFF].

INITIAL SETTINGS

Calendar/clock settings

- 1 Display the source/option selection screen. On the Home screen or the source control screen:



- 2 Display the <SETUP> screen.

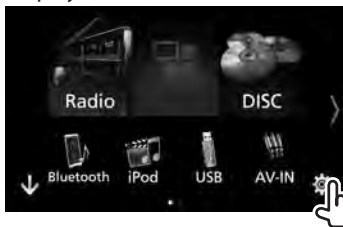

- 3 Display the <User Interface> screen.



- 4 Select the method to set the clock.
 - Scroll the page to show the item.



[GPS-SYNC] Synchronizes the clock time with the GPS.

[Manual] Sets the clock manually. (See the right column.)

- To close the window, touch [Close].

- 5 Select the appropriate time zone for [Time Zone].



- To return to the Home screen, press HOME on the monitor panel, or touch [←] to return to the previous screen.

To adjust the clock manually (when selecting [Manual] on the <Clock> window)

- 1 Display the <Clock Adjust> screen. On the <User Interface> screen (see the far left column):
 - Scroll the page to show the item.

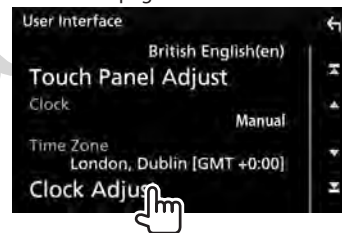

- 2 Set the calendar and the clock time (①), then confirm the adjustment (②).

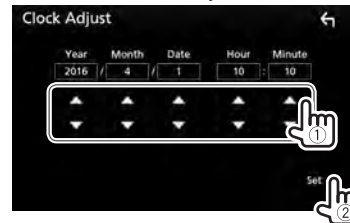

BASICS

Component names and functions

⚠ Caution on the volume setting:

Digital devices produce very little noise compared with other sources. Lower the volume before playing these digital sources to avoid damaging the speakers by sudden increase of the output level.

DDX9716BTS/DDX9716BTSR

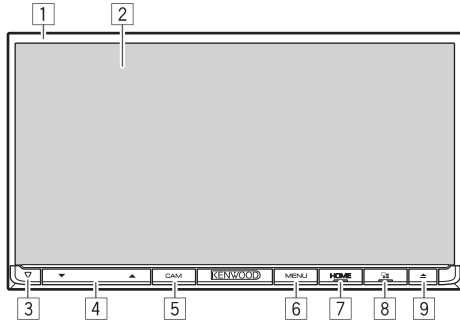

- 1 Monitor panel*
- 2 Screen (touch panel)
- 3 Power indicator/Security indicator
 - Lights up while the unit is turned on.
 - Flashes when the security function is activated. (Page 5)
- 4 VOLUME ▼/▲ button
 - Adjusts the audio volume. (Page 8)
- 5 CAM button
 - Displays the picture from the connected camera. (Press) (Page 37)
- 6 MENU button
 - Displays the pop-up short-cut menu. (Press) (Page 13)

- 7 HOME/⏪ button
 - Displays the Home screen. (Press) (Page 9)
 - Turns on the power. (Press) (Page 8)
 - Turns off the power. (Hold) (Page 8)
- 8 /VOICE button
 - Displays the App (CarPlay/ Android Auto) screen. (Press) (Pages 24 and 25)
 - Activates the voice control function. (Hold)
 - When a Bluetooth mobile phone is connected: Activates the voice dialing. (Page 47)
 - When an Android device compatible with Android Auto is connected: Activates voice control. (Page 24)
 - When iPod/iPhone compatible with Apple CarPlay is connected: Activates Siri. (Page 25)
- 9 (Eject) button
 - Displays the <Angle Adjust> screen. (Press) (Page 8)
 - Forcibly ejects the disc. (Hold)

* You can change the color of the buttons on the monitor panel. (Page 59)

DDX8016DABS

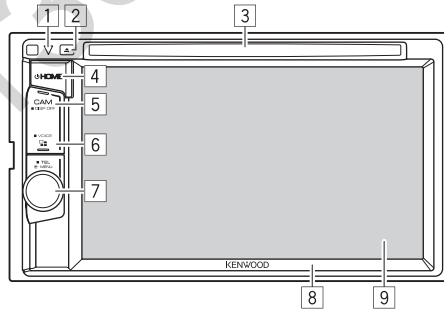

- 1 Power indicator/Security indicator
 - Lights up while the unit is turned on.
 - Flashes when the security function is activated. (Page 5)
- 2 (Eject) button
 - Ejects the disc. (Press) (Page 14)
 - Forcibly ejects the disc. (Hold)
- 3 Loading slot
- 4 HOME/⏪ button
 - Displays the Home screen. (Press) (Page 9)
 - Turns on the power. (Press) (Page 8)
 - Turns off the power. (Hold) (Page 8)
- 5 CAM/DISP OFF button
 - Displays the picture from the connected camera. (Press) (Page 37)
 - Turns off the screen. (Hold) (Page 8)
- 6 /VOICE button
 - Displays the App (CarPlay) screen. (Press) (Pages 24 and 25)
 - Activates the voice control function. (Hold)
 - When a Bluetooth mobile phone is connected: Activates the voice dialing. (Page 47)
 - When iPod/iPhone compatible with Apple CarPlay is connected: Activates Siri. (Page 25)
- 7 Volume/MENU/TEL knob
 - Displays the pop-up short-cut menu. (Press) (Page 13)
 - Displays the phone control screen. (Hold) (Page 45)
 - Adjusts the audio volume. (Turn) (Page 8)
- 8 Monitor panel*
- 9 Screen (touch panel)

* You can change the color of the buttons on the monitor panel. (Page 59)

BASICS

Common operations

Turning on the power

DDX9716BTS
DDX9716BTSR



DDX8016DABS



Turning off the power

DDX9716BTS
DDX9716BTSR



DDX8016DABS



Adjusting the volume

To adjust the volume (0 to 35)

DDX9716BTS
DDX9716BTSR



Press ▲ to increase, and press ▼ to decrease.

- Holding ▲ increases the volume continuously to level 15.

DDX8016DABS



Turn to the right to increase, and turn to the left to decrease.

Turning off the screen

On the touch panel:

Select **[Display OFF]** on the pop-up short-cut menu.
(Page 13)



On the monitor panel:

DDX8016DABS



To turn on the screen: Press and hold the same button, or touch the display.

Monitor panel operations — <Angle Adjust> (Only for DDX9716BTS/ DDX9716BTSR)

- 1 Display the <Angle Adjust> screen.



2



[←]

Exits the <Angle Adjust> screen.

[0] – [6]

Selects a monitor angle.

[▲DISC EJECT]

Ejects the disc.

<Off Position>

Sets the angle of the monitor when the power is turned off.

- Select the monitor angle, then touch **[Memory]**.

To close the monitor panel: Press ▲ on the monitor panel.

BASICS

❑ Putting the unit in standby

- 1 Display the source/option selection screen.
On the Home screen or the source control screen:



- 2 Touch **[STANDBY]** on the source/option selection screen.

- Touch **[]** to change the page.

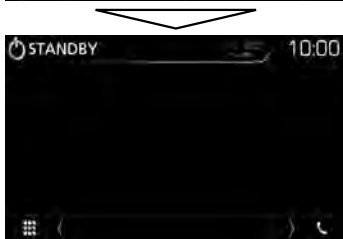
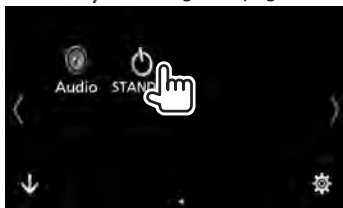

Common screen operations

❑ Touch screen operations

To perform operations on the screen, you need to touch, touch and hold, flick or swipe to select an item, display setting menu screen or to change the page, etc.

Touch

Touch the screen gently to select an item on the screen.

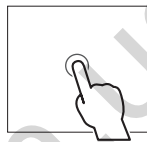

Touch and hold

Touch the screen and keep your finger in place until the display changes or a message is displayed.

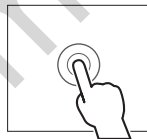

Flick

Slide your finger quickly to the left or right on the screen to change the page.

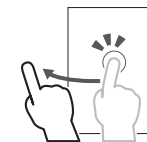

Swipe

Slide your finger up or down on the screen to scroll the screen.

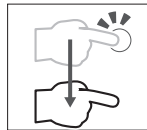

❑ Home screen descriptions

You can select playback sources, display setting screens, or display information on the Home screen.

- To display the Home screen, press HOME on the monitor panel.



Common operation buttons and indications:

- 1 Displays the control screen of current source
 - 2 Widget
 - Touching the widget displays the detailed information/setting screen.
 - You can change the widget by touching **[</>]** or flicking left or right on the widget area.
 - 3 Page indication for widgets
 - 4 Current source information
 - 5 Displays the source/option selection screen. (Page 10)
 - 6 Short-cut playback source icons (Page 13)
 - 7 Displays the phone control screen. (Page 45)
- When connecting as Apple CarPlay or Android Auto, it works as a phone provided in Apple CarPlay or Android Auto.

BASICS

❑ Source/option selection screen descriptions

You can display all playback sources and options on the source/option selection screen.

- You can customize the source/option selection screen. (Page 13)

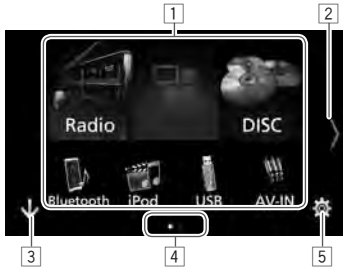

Common operation buttons and indications:

- 1 Changes the playback source or displays a setting/information screen.
 - For playback sources and setting screens, see page 12.
- 2 Changes the page. (Touch [⏪] or [⏩].)
 - You can also change the page by flicking left or right on the screen.
- 3 Displays the Home screen. (Page 9)
- 4 Page indication
- 5 Displays the <SETUP> screen. (Page 11)

❑ Source control screen descriptions

You can perform source playback operations on the source control screen.

- The operation buttons and information displayed vary depending on the selected source.

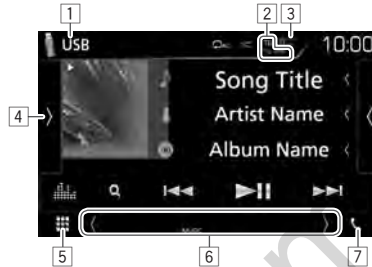

Common operation buttons and indications:

- 1 Current source or media
- 2 Connected Bluetooth device information (Page 40)
- 3 Battery charge indication: Lights up when quick charging battery of the connected iPod/ iPhone/ Smartphone.
- 4 Displays the other operation button window.*
- 5 Displays the source/option selection screen. (See the left column.)

- 6 Short-cut source selection buttons/the indicators for the current source

- Each time you touch [⏪] or [⏩], the items shown in this area change.

- The indicators for the current source



- The short-cut source selection buttons (Page 13)



- Touching one of the buttons displays the selected source.

- 7 Displays the phone control screen. (Page 45)
When connecting as Apple CarPlay or Android Auto, it works as a phone provided in Apple CarPlay or Android Auto.

- * Does not appear when there are no other operation buttons other than those currently shown on the source control screen.

BASICS

❑ <SETUP> screen descriptions

You can change the detailed settings. (Page 62)



Common operation buttons and indications:

- 1 Selects the menu category.
- 2 Returns to the previous screen.
- 3 Changes the page.
[▲]/[▼]: Scrolls the page.
• You can also scroll the page by swiping on the touch panel.
[▲]/[▼]: Displays the top or bottom page.

❑ List screen descriptions

During audio/video source playback, you can select the desired item easily from the list.



Common operation buttons and indications:

- Available buttons on the screen and operations differ depending on the type of file/media being played back.
- 1 Displays list type selection window.
 - 2 Selects the file type ([🎵]: audio/[📺]: video).
 - 3 Returns to the previous screen.
 - 4 Scrolls the text if not all of the text is shown.
 - 5 Searches for a folder/track.
▶ **Play**: Plays all tracks in the folder containing the current track.
[Q] **A-Z**: Enters the initial search mode.
[🏠] **Top**: Returns to the top layer.
[📁] **Up**: Returns to the upper layer.
 - 6 Changes the page.
[▲]/[▼]: Scrolls the page.
• You can also scroll the page by swiping on the touch panel.
[▲]/[▼]: Displays the top or bottom page.

❑ Playback operations during video playback

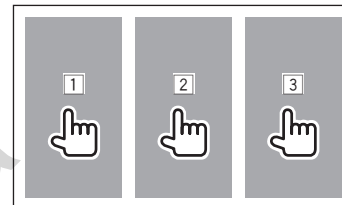

- 1 Selects a previous chapter/track/item.
- 2 Displays the source control screen while playing a video.



- The operation buttons disappear when [**Hide**] is touched or when no operation is done for about 5 seconds.
- 3 Selects a next chapter/track/item.

BASICS

Selecting the playback source/ option

- 1 Display the source/option selection screen.
On the Home screen or the source control screen:



- 2 Select a source/option.

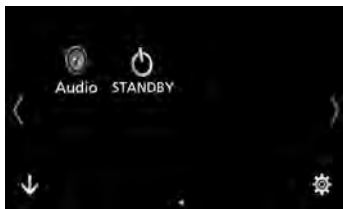

- To display more items, touch [**</[]>**] or flick to change the page.

[Android Auto]/[Apple CarPlay]^{*1 *2}

Switches to the Android Auto/Apple CarPlay/App screen from the connected iPod touch/iPhone/Android device^{*2}. (Pages 24 – 25)

[Radio]

Switches to the radio broadcast. (Page 27)

[Bluetooth]

Plays a Bluetooth audio player. (Page 49)

[DISC]

Plays a disc. (Page 14)

[iPod]

Plays an iPod/iPhone. (Page 21)

[USB]

Plays files on a USB device. (Page 18)

[DAB]^{*3}

Switches to the digital audio broadcast (DAB). (Page 31)

[AV-IN1]^{*3}

Switches to an external component connected to the AV-IN1 input terminal. (Page 37)

[AV-IN]^{*4} or [AV-IN2]^{*3}

Switches to an external component connected to the AV-IN^{*4} or AV-IN2^{*3} input terminal. (Page 37)

[Audio]

Displays the sound adjustment screen. (Page 53)

[STANDBY]

Puts the unit in standby. (Page 9)

[]

Displays the <SETUP> menu screen. (Page 62)

^{*1} When iPhone compatible with CarPlay is connected and <CarPlay Connection> is set to [ON] (Page 25), [Apple CarPlay] is displayed. When an Android device compatible with Android Auto is connected, [Android Auto] is displayed.

^{*2} Android Auto is available only for DDX9716BTS/DDX9716BTSR.

^{*3} Only for DDX8016DABS.

^{*4} Only for DDX9716BTS/DDX9716BTSR.

BASICS

Selecting the playback source on the Home screen



- The 3 items displayed on the source/option selection screen as the large icons are shown on the Home screen.
- You can change items displayed on this area by customizing the source/option selection screen. (See the right column.)

Selecting the playback source on the source control screen

Display source selection buttons by touching [$\langle \rangle$] on the source control screen (Page 10), then select a playback source.



- The 3 items displayed on the source/option selection screen as the short-cut selection buttons.
- You can change items displayed as the short-cut source selection buttons by customizing the source/option selection screen. (See the right column.)

Customizing the source/option selection screen

You can arrange the items to display on the source/option selection screen.

Touch and hold the item you want to move until boxes appear around the icons, then drag it to the position you want to move it to .

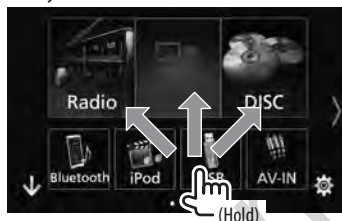

Using the pop-up short-cut menu

While displaying the source control screen, you can jump to another screen from the pop-up short-cut menu.

- 1 Display the pop-up short-cut menu.

DDX9716BTS
DDX9716BTSR

DDX8016DABS



- 2 Select an item to jump to.

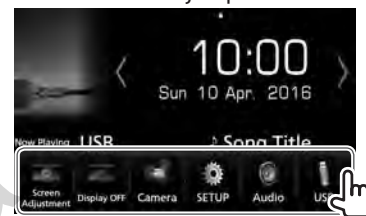

[Screen Adjustment] Displays the picture adjustment screen. (Page 58)

[Display OFF] Turns off the screen. (Page 8)

[Camera] Displays the picture from the connected camera. (Page 37)

[SETUP] Displays the <SETUP> screen. (Page 62)

[Audio] Displays the sound adjustment screen. (Page 53)

[USB] Displays the control screen of current source. Icon feature differs depending on the source.

To close the pop-up menu: Touch the screen anywhere other than the pop-up short-cut menu, or press MENU on the monitor panel.

DISCS

Playing a disc

- If a disc does not have a disc menu, all tracks on it will be played repeatedly until you change the source or eject the disc.
- For playable disc types/file types, see page 76.

❑ Inserting a disc

Insert a disc with the label side facing up.

- For DDX9716BTS/DDX9716BTSR: To open the monitor panel, see page 8.

DDX9716BTS
DDX9716BTSR

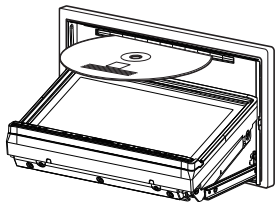

DDX8016DABS

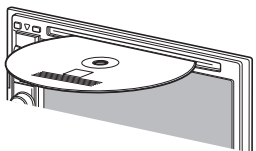

- The source changes to "DISC" and playback starts.
- The IN indicator lights up while a disc is inserted.

- If "⊘" appears on the screen, the unit cannot accept the operation you have tried to do.
 - In some cases, without showing "⊘," operations will not be accepted.
- When playing back a multi-channel encoded disc, the multi-channel signals are downmixed to stereo.

❑ Ejecting a disc

DDX9716BTS/DDX9716BTSR

Press **▲** on the monitor panel, then select **[▲ DISC EJECT]** on the **<Angle Adjust>** screen.



DDX8016DABS



When removing a disc, pull it horizontally.

- You can eject a disc when playing another AV source.
- If the ejected disc is not removed within 15 seconds, the disc is automatically inserted again into the loading slot to protect it from dust.

To eject a disc forcibly

Press and hold **▲** on the monitor panel. A confirmation message appears. Touch **[Yes]**.

To close the monitor panel (Only for DDX9716BTS/DDX9716BTSR)

After removing the disc, press **▲** on the monitor panel. The monitor panel closes.

Playback operations

- When the operation buttons are not displayed on the screen, touch the area shown on the illustration.
- To change settings for video playback, see page 58.



❑ Indications and buttons on the source control screen

For video playback



Playback information

- The information displayed on the screen differs depending on the type of disc/file being played back.

- 1 Media type
- 2 Playback mode (Page 17)
- 3 Current playback item information (title no./chapter no./folder no./file no./track no.)
- 4 IN indicator: A disc is inserted.

DISCS

Operation buttons

- Available buttons on the screen and operations differ depending on the type of disc/file being played back.

[Hide]	Hides the indicators and buttons.
[>]	Displays the other operation button window. <ul style="list-style-type: none">• To hide the window, touch [<].
[🔄]	Selects Repeat playback mode. (Page 17)
[🎲]	Selects Random playback mode. (Page 17)
[📊]	Displays the <Graphic Equalizer> screen. (Page 54)
[Q]	Displays the folder/track list. (Page 16)
[⏮] [⏭]	Selects a chapter/track. (Touch) • Reverse/forward search. (Hold)
[⏸]	Starts/pauses playback.
[⏮] [⏭]	Reverse/forward search during playback.
[<] [>]	Plays in slow-motion.
[■]	Stops playback.
[SETUP]	Changes the settings for disc playback on the <DVD SETUP> screen. (Page 18)
[MENU CTRL]	Displays the video menu screen. (Page 17)
[+] [-]	Selects a folder.
[PBC]	Activates or deactivates the VCD PBC (Playback Control) function. (Page 16)
[Audio]	Change the audio output channel. (VCD only)

- To display all available operation buttons, touch [>] to display the other operation button window.

For audio playback

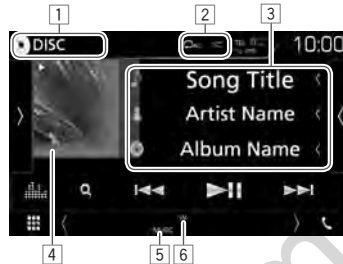

Playback information

- The information displayed on the screen differs depending on the type of disc/file being played back.
 - 1 Media type
 - 2 Playback mode (Page 17)
 - 3 Track/file information
 - Touching [<] scrolls the text if not all of the text is shown.
 - 4 Jacket picture (Shown while playing if the file has tag data that includes the jacket picture)
 - 5 File type
 - 6 IN indicator: A disc is inserted.

Operation buttons

- Available buttons on the screen and operations differ depending on the type of disc/file being played back.
 - [>] Displays the other operation button window.
 - To hide the window, touch [<].
 - [<] Displays the track list of the folder containing the current track. (Page 16)
 - To hide the list, touch [>].
 - [🔄] Selects Repeat playback mode. (Page 17)
 - [🎲] Selects Random playback mode. (Page 17)
 - [📊] Displays the <Graphic Equalizer> screen. (Page 54)
 - [Q] Displays the folder/track list. (Page 16)
 - [⏮] [⏭] Selects a track.
 - [⏸] Starts/pauses playback.
 - [+] [-] Selects a folder.
- To display all available operation buttons, touch [>] to display the other operation button window.

DISCS

❑ Selecting a folder/track on the list

To search all folders/tracks in a disc

1 Display the folder/track list.

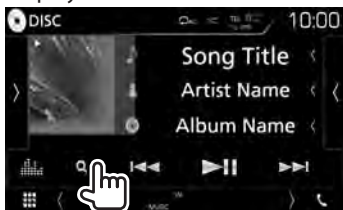

2 Select an item.

- Proceed until you select the desired track.
- For details about the list operation, see page 11.



To search in the folder containing the current track

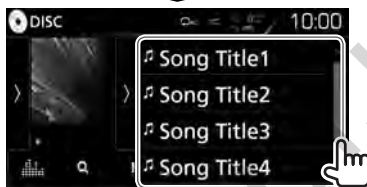
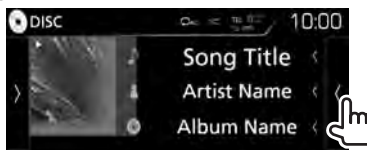

- Scroll the page to show more items.
- To hide the list, touch [X].

❑ Activating PBC (Playback Control) function (for VCD only)

While playing a VCD with PBC...

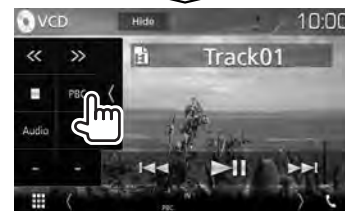
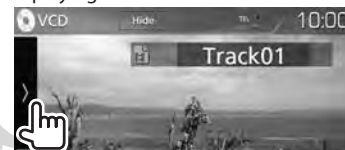

- The PBC indicator lights up.
- To select a track directly while PBC is activated, operate from the remote controller.* (Page 65)

To deactivate PBC: Touch [PBC]. (The PBC indicator turns off.)

* Purchase KNA-RCDV331 separately.

DISCS

❑ Video menu operations (except for VCD)

You can display the video menu screen during video playback.

- The operation buttons disappear when **[Hide]** is touched or when no operation is done for about 5 seconds.

1 Display the video menu screen.

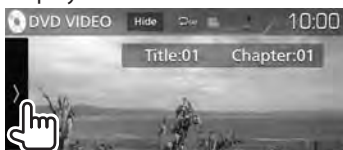

2



- Available buttons on the screen and operations differ depending on the type of disc/file being played back.

- [TOP]** Displays the top menu.
- [MENU]** Displays the disc menu.
- [Return]** Displays the previous screen.
- [Enter]** Confirms the selection.
- [Highlight]** Switches to the direct disc menu mode. Touch the target item to select.
 - The menu screen disappears when no operation is done for 5 seconds.
- [↶]** Returns to the playback screen.
- [Angle]** Selects the view angle.
- [Subtitle]** Selects the subtitle type.
- [Audio]** Selects the audio type.
- [▲][▼][◀▶]** Selects an item.

❑ Selecting playback mode

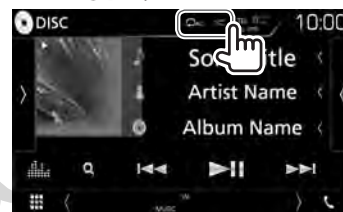

- [🔄]** Selects Repeat playback mode.
- [🎲]** Selects Random playback mode.

- Available playback modes differ depending on the type of disc/file being played back.
- Each time you touch the button, the playback mode changes. (The current playback mode is shown as the button.)

– Available items differ depending on the type of disc/file being played back.

- [🔄CAP]** Repeats current chapter.
- [🔄TIT]** Repeats current title.
- [🔄0]** Repeats current track.
- [🔄📁]** Repeats all tracks of the current folder.
- [🔄ALL]** Repeats all tracks in the disc.
- [🎲📁]** Randomly plays all tracks of the current folder, then tracks of the next folders.
- [🎲ALL]** Randomly plays all tracks.

- To cancel random mode, touch the button repeatedly until it is grayed out.

DISCS

Settings for DVD playback

1

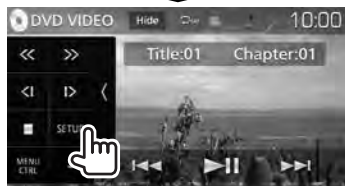
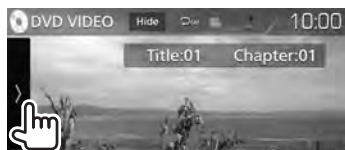

2



- Scroll the page to show more items.
- Available items shown on the <DVD SETUP> screen differ depending on the type of disc/file being played back.

Setting items

[Menu Language]	Select the initial disc menu language. (Initial: English) (Page 78)
[Subtitle Language]	Select the initial subtitle language or turn subtitles off (Off). (Initial: English) (Page 78)
[Audio Language]	Select the initial audio language. (Initial: Original) (Page 78)
[Dynamic Range Control]	You can change the dynamic range while playing using Dolby Digital software. <ul style="list-style-type: none">• Wide: Select this to enjoy a powerful sound at a low volume level with its full dynamic range.• Normal: Select this to reduce the dynamic range a little.• Dialog (Initial): Select this to reproduce movie dialog more clearly.
[Screen Ratio]	Select the monitor type to watch a wide screen picture on the external monitor. 16:9 (Initial) 4:3 LB 4:3 PS 

USB

Connecting a USB device

You can connect a USB mass storage class device such as a USB memory, Digital Audio Player, etc. to the unit.

- For details about connecting USB devices, see page 71.
- You cannot connect a computer or portable HDD to the USB input terminal.
- For playable file types and notes on using USB devices, see page 77.

- 1 Connect the USB device to the unit with an USB cable.
- 2 Select "**USB**" as the source. (Page 12)

To disconnect the USB device

- 1 Select a source other than "**USB**". (Page 12)
- 2 Detach the USB device.

Playback operations

When the operation buttons are not displayed on the screen, touch the area shown on the illustration.

- To change settings for video playback, see page 58.

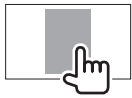

Indications and buttons on the source control screen

For audio playback



For video playback



Playback information

The information displayed on the screen differs depending on the type of file being played back.

- 1 Playback mode (See below.)
- 2 Track/file information
 - Touching [**<**] scrolls the text if not all of the text is shown.
- 3 Jacket picture (Shown while playing if the file has tag data that includes the jacket picture)
- 4 File type

Operation buttons

Available buttons on the screen and operations differ depending on the type of file being played back.

[Hide] Hides the indicators and buttons.

[>] Displays the other operation button window.

- To hide the window, touch [**<**].

[<] Displays the track list of the folder containing the current track.

- To hide the list, touch [**>**].

[Repeat] Selects Repeat playback mode.

- [Repeat]: Repeats the current track/file.
- [Repeat Folder]: Repeats all tracks/files in the current folder or specified category.
- [Repeat All]: Repeats all tracks/files in the USB device.

[Shuffle] Randomly plays all tracks in current folder.* (Shuffle indicator lights up.)

[Equalizer] Displays the <Graphic Equalizer> screen. (Page 54)

[Q] Displays the list. (Page 20)

- [Previous] [Next]: Selects a track. (Touch)
- [Hold Previous] [Hold Next]: Reverse/forward search. (Hold)

[Play/Pause] Starts/pauses playback.

[Folder] [Folder] Selects a folder.

- To display all available operation buttons, touch [**>**] to display the other operation button window.

- * To cancel random mode, touch the button repeatedly until it is grayed out.

❑ Selecting a track in a list

To search all folders/tracks in a USB device

1 Display the list.

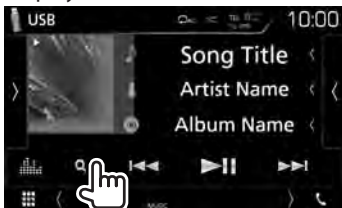

2 Select the list type.

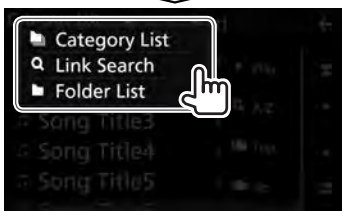
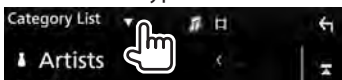

3 Select the desired track.

- Proceed until you select the desired track.
- For details about the list operation, see page 11.

From <Category List>:

- ① Select the file type.
- ② Select a category, then the item in the selected category.

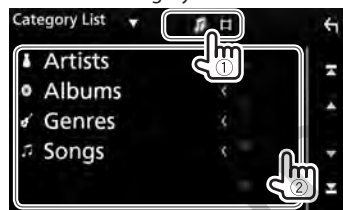

From <Link Search>:

- ① Select the file type.
- ② Select the tag type to display a list of content that contains the same tag as the track/file currently being played, then select the item.



From <Folder List>:

Select the folder, then the item in the selected folder.



To search in the folder containing the current track

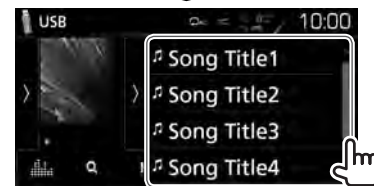
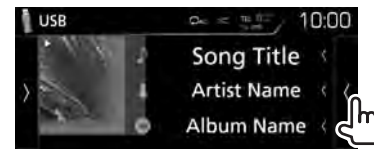

- Scroll the page to show more items.
- To hide the list, touch [I].

iPod/iPhone

Preparation

❑ Connecting iPod/iPhone

- For details about connecting iPod/iPhone, see page 71.
- For playable iPod/iPhone types, see page 77.

Connect your iPod/iPhone according to your purpose or the type of iPod/iPhone.

Wired connection

• To listen to music:

- For Lightning connector models: Use USB Audio cable for iPod/iPhone—KCA-iP103 (optional accessory).
- For 30-pin connector models: Use USB Audio cable for iPod/iPhone—KCA-iP102 (optional accessory).

• To watch video and listen to music:

- For Lightning connector models: You cannot watch the video.

Bluetooth connection

Pair the iPod/iPhone through Bluetooth. (Page 40)

- You cannot watch video with a Bluetooth connection.

❑ Selecting the connection method

- 1 Display the source/option selection screen.
On the Home screen or the source control screen:



- 2 Display the <SETUP> screen.



- 3 Display the <AV> screen.



- 4 Set **[Automotive Mirroring]** to **[OFF]**.



- 5 Display the <APP/iPod SETUP> screen.

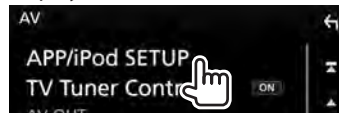

- 6 Select the connection method of iPod/iPhone for <APP Connection select>.



[iPhone USB]

Select this when iPod/iPhone is connected using KCA-iP102 (optional accessory) or KCA-iP103 (optional accessory).

[iPhone Bluetooth]

Select this when iPod/iPhone is connected via Bluetooth.

- 7 Finish the procedure.

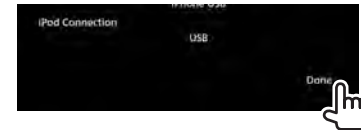

Playback operations

When the operation buttons are not displayed on the screen, touch the area shown on the illustration.

- To change settings for video playback, see page 58.

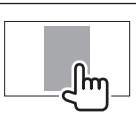

Indications and buttons on the source control screen



Playback information

- 1 Playback mode (See the right column.)
- 2 Song information
 - Touching [<] scrolls the text if not all of the text is shown.
- 3 Artwork (Shown if the track contains artwork)
- 4 File type

Operation buttons

- Available buttons on the screen and operations differ depending on the type of file being played back.

- [<] Displays the track list of the category containing the current track.
 - To hide the list, touch [>].
- [⏮] Selects Repeat playback mode.
 - [⏮]: Functions the same as Repeat One.
 - [⏮] ALL: Functions the same as Repeat All.
- [🔄] Selects random playback mode.*
 - [🔄]: Functions the same as Shuffle Songs.
 - [🔄] [📁]: Functions the same as Shuffle Albums.
- [📊] Displays the <Graphic Equalizer> screen. (Page 54)
- [Q] Displays the list. (Page 23)
- [⏪] [⏩]
 - Selects a track. (Touch)
 - Reverse/forward search. (Hold)
- [⏸] Starts/pauses playback.

* To cancel random mode, touch the button repeatedly until it is grayed out.

iPod/iPhone

❑ Selecting an audio track from the list

To search all tracks in iPod/iPhone

1 Display the list.



2 Select the list type.

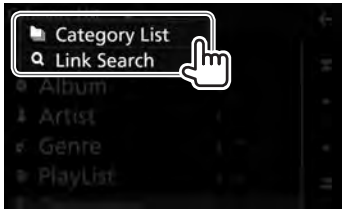

3 Select the desired track.

- Proceed until you select the desired track.
- For details about the list operation, see page 11.

From <Category List>:

Select a category, then the item in the selected category.

- Available categories differ depending on the type of your iPod/iPhone.



From <Link Search>:

Select the tag type to display a list of content that contains the same tag as the track/file currently being played, then select the item.



To search in the folder containing the current track

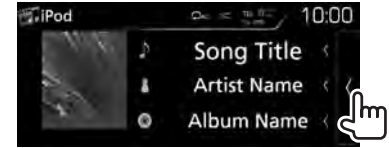

- Scroll the page to show more items.
- To hide the list, touch [X].

APPS—Android Auto™/Apple CarPlay

You can use an App of the connected iPod touch/iPhone/Android on this unit.

- You can use an App on the following sources:
 - Only for DDX9716BTS/DDX9716BTSR: When an Android device compatible with Android Auto is connected: “**Android Auto**” (See below)
 - When iPhone compatible with CarPlay is connected: “**Apple CarPlay**” (Page 25)

Using the Apps of an Android device—Android Auto™ (Only for DDX9716BTS/DDX9716BTSR)

□ About Android Auto

Android Auto enables you to use functions of your Android device convenient for driving. You can easily access route guidance, make calls, listen to music, and access convenient functions on the Android device while driving.

- For details about Android Auto, visit <<https://www.android.com/auto/>> and <<https://support.google.com/androidauto>>.

Compatible Android devices

You can use Android Auto with Android devices of Android version 5.0 (Lollipop) or later.

Android Auto may not be available on all devices and is not available in all countries or regions.

□ Preparation

To use the navigation function of Google Maps™, connect a GPS antenna. (Page 73)

- 1 Set [**Automotive Mirroring**] to [**ON**]. (Page 25)
- 2 Connect an Android device using a Micro USB to USB cable (commercially available). (Page 72)
 - To use the hands-free function, connect the Android device via Bluetooth. (Page 40)
 - When an Android device compatible with Android Auto is connected to the USB input terminal, the device is connected via Bluetooth automatically, and the Bluetooth mobile phone currently connected is disconnected.
 - Unlock your Android device.
- 3 Select “**Android Auto**” as the source. (Page 12)
 - [**Android Auto**] is displayed only when a compatible Android device is connected.

□ Operation buttons and available Apps on the Android Auto screen

You can perform the operations of the Apps of the connected Android device.

- The items displayed on the screen differ depending on the connected Android device.

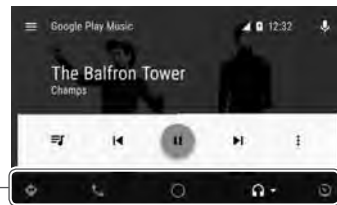

- 1 Application/information buttons
Starts the application or displays information.

To exit the Android Auto screen: Press HOME on the monitor panel.

□ Using voice control



- To cancel the voice control, press and hold the same button again.

□ Switching to the Android Auto screen while listening to another source



To return to the source control screen: Press the same button again.

APPS—Android Auto™/Apple CarPlay

Using Apps of iPhone—Apple CarPlay

❑ About CarPlay

CarPlay is a smarter, safer way to use your iPhone in the car. CarPlay takes the things you want to do with iPhone while driving and displays them on the screen of the unit. You can get directions, make calls, send and receive messages, and listen to the music from iPhone while driving. You can also use Siri voice control to make it easier to operate iPhone.

- For details about CarPlay, visit <<https://ssl.apple.com/ios/carplay/>>.

Compatible iPhone devices

You can use CarPlay with the following iPhone models.

- iPhone 5
- iPhone 5c
- iPhone 5s
- iPhone 6
- iPhone 6 Plus
- iPhone 6s
- iPhone 6s Plus

Although the service area is expanding, CarPlay service is NOT available in some markets. Please check the latest information concerning availability in your region from the below website.
<http://www.apple.com/ios/featureavailability/#applecarplay-applecarplay>

❑ Preparation

To use the navigation function of the maps App, connect a GPS antenna. (Page 73)

- 1 Configure the settings to use Apple CarPlay on the <AV> screen.
On the Home screen or the source control screen:

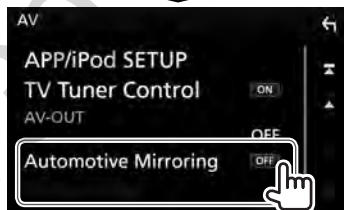
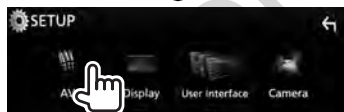

[CarPlay Connection]

Select **[ON]** to use Apple CarPlay.

[CarPlay Sidebar]

Select the position of the control bar (left or right) shown on the touch panel.

- 2 Connect iPhone using KCA-iP103 (optional accessory). (Page 71)

- When iPhone compatible with CarPlay is connected to the USB input terminal, the Bluetooth mobile phone currently connected is disconnected.
- Unlock your iPhone.

- 3 Select **"Apple CarPlay"** as the source. (Page 12)

- **[Apple CarPlay]** is displayed on the Home screen or the source/option selection screen only when a compatible iPhone is connected.

❑ Using Siri

You can activate Siri while the CarPlay screen is displayed.

On the home screen of CarPlay:

- 1 Touch and hold **[Ⓞ]** to activate Siri.

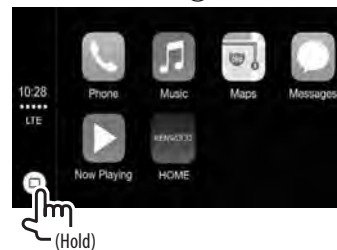

- 2 Talk to Siri.

- You can also activate Siri by pressing and holding **[☰]/VOICE** on the monitor panel.
 - To deactivate, press **[☰]/VOICE** on the monitor panel.

APPS—Android Auto™/Apple CarPlay

❑ Operation buttons and available Apps on the home screen of CarPlay

You can use the Apps of the connected iPhone.

- The items displayed and the language used on the screen differ depending on the connected device.

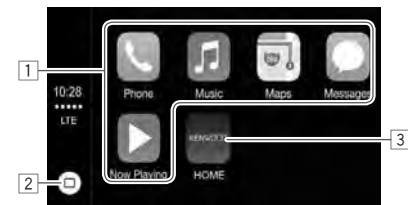

- 1 Application buttons
Starts the application.

2 [⏏] button

- On the App screen: Displays the home screen of CarPlay. (Touch)
- On the home screen of CarPlay: Activates Siri. (Hold) (Page 25)

3 [HOME] button

Exits the CarPlay screen and displays the Home screen.

To exit the CarPlay screen: Press HOME on the monitor panel.

❑ Switching to the Apple CarPlay screen while listening to another source

DDX9716BTS

DDX8016DABS

DDX9716BTSR



To return to the source control screen: Press the same button again.

Radio

Listening to the radio

Indications and buttons on the source control screen



Radio reception information

- 1 Preset no.
- 2 Seek mode (See the right column.)
- 3 Text information
 - Touching [<] scrolls the text if not all of the text is shown.
 - Touching [Ⓢ] switches the information as follows:
 - Frequency/PS name/Radio Text/title and artist
 - Frequency/PTY genre/Radio Text plus
- 4 Preset list (Page 28)
- 5 Standby reception indicators (Page 29)
- 6 AF indicator (Page 30)
- 7 LO.S indicator (See the far right column.)
- 8 ST/MONO indicator: Lights up when receiving an FM stereo broadcast with sufficient signal strength.
- 9 RDS indicator: Lights up when receiving a Radio Data System station.
- 10 EON indicator: Lights up when a Radio Data System station is sending EON signals.

Operation buttons

- [AUTO1]/ [AUTO2]/ [MANUAL] Changes the seek mode. Each time you touch the button, the seek mode changes as follows:
- **AUTO1**: Auto search
 - **AUTO2**: Tunes in stations in the memory one after another.
 - **MANUAL**: Manual search
- [>] Displays the other operation button window.
- [<] Displays the preset list.
- To hide the window, touch [<].
 - To hide the list, touch [>].
- [AM] Selects the AM band.
- [FM] Selects the FM band.
- [EQ] Displays the <Graphic Equalizer> screen. (Page 54)
- [<<] [>>] Searches for a station.
- The search method differs according to the selected seek mode. (See above.)
- [TI]* Activates/deactivates TI standby reception mode. (Page 29)
- [SETUP] Changes the settings for radio reception on the <Radio SETUP> screen. (Pages 29 – 30)
- [AME] Presets stations automatically. (Page 28)
- [PTY]* Enters PTY search mode. (Page 28)
- [MONO] Activates/deactivates monaural mode for better FM reception. (Stereo effect will be lost.)
- The MONO indicator lights up while monaural mode is activated.
- [LO.S]* Activates/deactivates the local seek mode (See the right column.)

- To display all available operation buttons, touch [>] to display the other operation button window.
- * Appears only when FM is selected as the band.

Tuning in FM stations only with strong signals—Local Seek

1 Display the <Radio SETUP> screen.

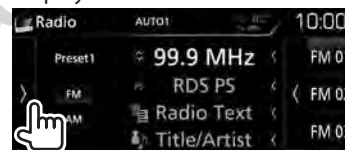

2



The unit tunes in only to stations with sufficient signal strength. The LO.S indicator lights up.

- You can also activate/deactivate the local seek by touching [LO.S] on the other operation button window.

To deactivate the Local function: Touch [LO.S] to select [OFF]. The LO.S indicator turns off.

Radio

Presetting stations

❑ Storing stations in the memory

You can preset 15 stations for FM and 5 stations for AM.

Automatic presetting—AME (Auto Memory)

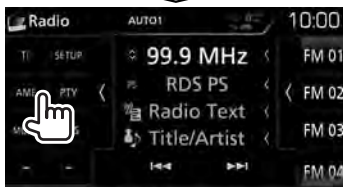
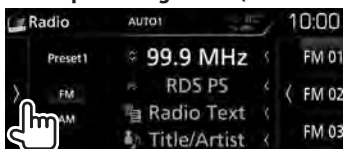

The confirmation message appears. Touch [Yes]. The local stations with the strongest signals are found and stored automatically.

Manual presetting

- 1 Tune in to a station you want to preset. (Page 27)
- 2 Display the preset list.

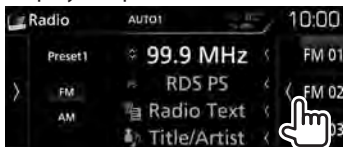

- 3 Select a preset number to store.



The station selected in step 1 is stored.

- Scroll the page to show more items.
- To hide the list, touch [].

❑ Selecting a preset station from the list

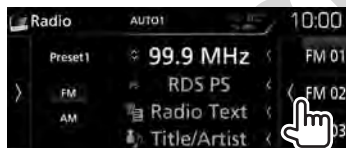

- Scroll the page to show more items.
- To hide the list, touch [].

FM Radio Data System features

❑ Searching for FM Radio Data System programs—PTY Search

You can search for your favorite programs being broadcast by selecting the PTY code.

- 1 Display the <PTY Search> screen.

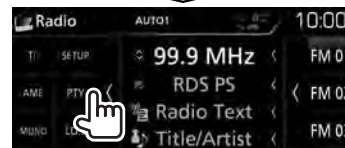
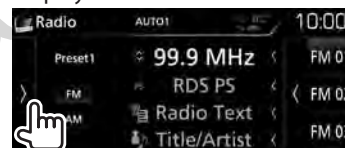

- 2 Select a PTY code (1), then start searching (2).

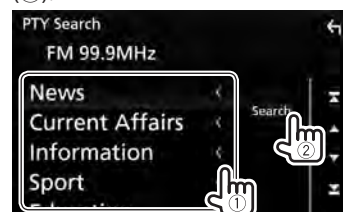

- Scroll the page to show more items.

PTY Search starts.
If there is a station broadcasting a program of the same PTY code as you have selected, that station is tuned in.

Radio

Selecting a language for the PTY search

- 1 Display the <Radio SETUP> screen.

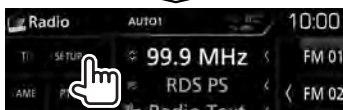
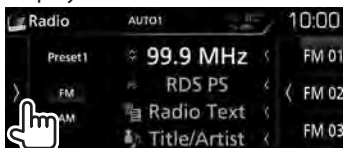

- 2



- 3 Select a language.



- Scroll the page to show more items.
- To close the window, touch [**Close**].

Activating/deactivating TI/News Standby Reception

TI Standby Reception

You can receive traffic information even while listening to another source by activating TI Standby Reception.

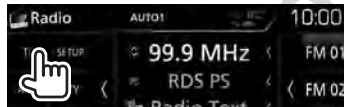
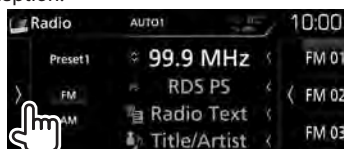

The unit is in standby to switch to Traffic Information (TI) if available.

- The TI indicator lights up in the following cases:
 - Lights in white: Receives the Traffic Information.
 - Lights in orange: On standby for traffic information reception.
- If the TI indicator is lit in orange, tune into another station providing Radio Data System signals.
- When traffic information is received, the screen switches to the Traffic Information screen automatically.

To deactivate TI Standby Reception: Touch [TI]. (The TI indicator turns off.)

- The volume adjustment for Traffic Information is automatically memorized. The next time the unit switches to Traffic Information, the volume is set to the previous level.
- For DDX8016DABS: The TI Standby Reception can also be activated or deactivated from “DAB” source control screen. (Page 33)

Radio

News Standby Reception

- 1 Display the <Radio SETUP> screen.

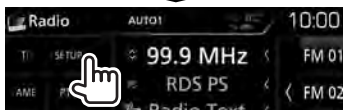
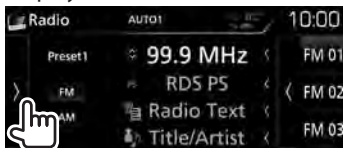

- 2



[00min] - Activate News Standby Reception (the NEWS indicator lights up).

[90min] Select the period of time to disable interruption.

[OFF] Deactivate the function.

- The volume adjustment while receiving News is automatically memorized. The next time the unit switches to News, the volume is set to the previous level.

Tracing the same program—Network-Tracking Reception

When driving in an area where FM reception is not sufficient enough, this unit automatically tunes in to another FM Radio Data System station of the same network, possibly broadcasting the same program with stronger signals.

- When shipped from the factory, Network-Tracking Reception is activated.

To change the Network-Tracking Reception setting

- 1 Display the <Radio SETUP> screen. (See the left column.)

- 2



[AF]

- **[ON]**: Switches to another station. The program may differ from the one currently received (the AF indicator lights up).
- **[OFF]**: Cancels.

[Regional]

- **[ON]**: Switches to another station broadcasting the same program (the AF indicator lights up).
- **[OFF]**: Cancels.

- The RDS indicator lights up when the Network-Tracking Reception is activated and an FM Radio Data System station is found.

Automatic TI station seek—Auto TP Seek

When traffic information station reception is poor, the unit automatically searches for another station that can be received better.

To activate Auto TP Seek

- 1 Display the <Radio SETUP> screen. (See the far left column.)

- 2



To deactivate Auto TP Seek: Touch [Auto TP Seek] to select [OFF].

DIGITAL RADIO (DAB) (Only for DDX8016DABS)

About DAB (Digital Audio Broadcasting)

What is DAB system?

DAB (Digital Audio Broadcasting) is one of the digital radio broadcasting systems available today. It can deliver digital quality sound without any annoying interference or signal distortion. Furthermore, it can carry text and data.

In contrast to FM broadcast, where each program is transmitted on its own frequency, DAB combines several programs (called "services") to form one "ensemble."

The "Primary component" (main radio station) is sometimes accompanied by a "secondary component" which can contain extra programs or other information.

Listening to Digital Radio

Indications and buttons on the source control screen

Live mode screen

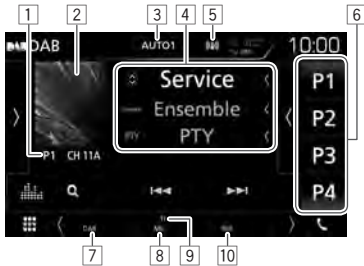

Digital radio reception information

- 1 Preset no./Channel no.
- 2 Album artwork
 - Touching the artwork displays the large artwork picture. To restore the screen, touch the artwork again.
- 3 Seek mode (See below.)
- 4 Text information
 - Touching [◀] scrolls the text if not all of the text is shown.
 - Touching [⊙] switches the information between channel name, artist name, song title, content information, category name, channel description, and similar channels.
- 5 Signal strength
- 6 Preset list (Page 32)
- 7 The DAB indicator: Lights up when receiving an DAB broadcast.
- 8 The MC indicator: Lights up when receiving an DAB multi component.
- 9 TI indicator (Page 33)
- 10 RDS indicator: Lights up when receiving an Radio Data System station.

Operation buttons

- [AUTO1]/
[AUTO2]/
[MANUAL]
- Changes the seek mode. Each time you touch the button, the seek mode changes as follows:
- **AUTO1**: Auto search
 - **AUTO2**: Tunes in stations in the memory one after another.
 - **MANUAL**: Manual search
- [})]
- Displays the other operation button window.
- To hide the window, touch [(<].
- [(<)]
- Displays the preset list.
- To hide the list, touch [})].



Displays the <Graphic Equalizer> screen. (Page 54)



Displays the <Service List> screen. (Page 32)



Searches for an ensemble, service, and component.

- The search method differs according to the selected seek mode. (See the left column.)



Activates/deactivates TI standby reception mode. (Page 33)



Changes the settings for Digital radio reception on the <DAB SETUP> screen. (Page 35)



Displays the replay mode screen. (Page 34)



Displays the live mode screen. (Page 34)



Enters PTY search mode. (Page 33)



Displays Dynamic Label Segment Screen (text messages the station sends).

- To display all available operation buttons, touch [})] to display the other operation button window.

DIGITAL RADIO (DAB)

❑ Selecting a service from the service list

1 Display the <Service List> screen.



2 Select a category (①), then select a service from the list (②).



- Touch [Q, A-Z] to search a service by initial.
- Touch and hold [↻] to update the <Service List>.

Presetting services

❑ Storing services in the memory

You can preset 15 services.

- 1 Select a service you want to preset. (Page 31)
- 2 Display the preset list.

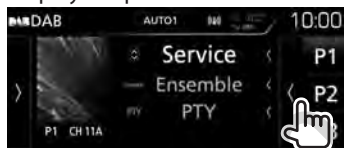

3 Select a preset number to store.



The station selected in step 1 is stored.

- Scroll the page to show more items.
- To hide the list, touch [)].

❑ Selecting a preset station from the list

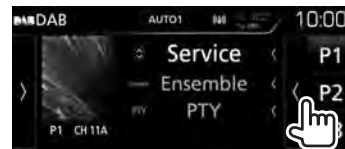

- Scroll the page to show more items.
- To hide the list, touch [)].

DIGITAL RADIO (DAB)

Radio Data System features

❑ Searching for Radio Data System programs—PTY Search

You can search for your favorite programs being broadcast by selecting the PTY code.

1 Display the <PTY Search> screen.

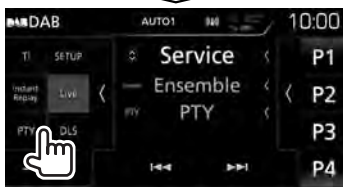
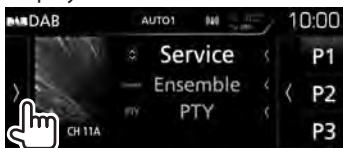

2 Select a PTY code (1), then start searching (2).

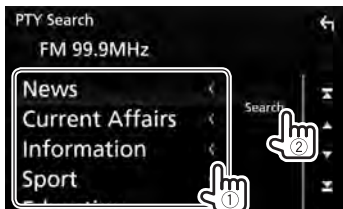

- Scroll the page to show more items. PTY Search starts. If there is a service broadcasting a program of the same PTY code as you have selected, that service is tuned in.

❑ Activating/deactivating TI Standby Reception

You can receive traffic information even while listening to another source by activating TI Standby Reception.

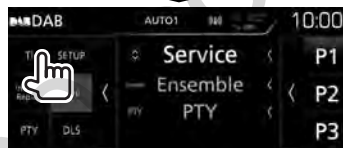
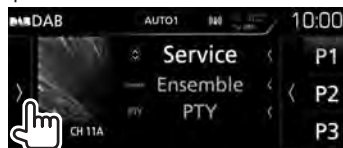

The unit is in standby to switch to Traffic Information (TI) if available.

- The TI indicator lights up in the following cases:
 - Lights in white: Receives the Traffic Information.
 - Lights in orange: On standby for traffic information reception.
- If the TI indicator is lit in orange, tune into another station providing Radio Data System signals.
- When traffic information is received, the screen switches to the Traffic Information screen automatically.

To deactivate TI Standby Reception: Touch [TI]. (The TI indicator turns off.)

- The volume adjustment for Traffic Information is automatically memorized. The next time the unit switches to Traffic Information, the volume is set to the previous level.
- The TI Standby Reception can also be activated or deactivated from "Radio" source control screen. (Page 29)

Using the Replay function

You can temporarily record the broadcast from the current time, and replay the recorded data.

- You can not use the Replay function (**[Instant Replay]** button is not available) in the following cases:
 - When the data is not recorded.
 - When receiving a service of the program type selected for **<PTY Watch>**. (Page 35)
- When the recording capacity is full, the older recorded data is deleted and recording continues.
- If you change to another channel during playback, the recorded content will be lost.

▣ Indications on the Replay mode screen



1 Replay time bar

Shows the remaining capacity (gray) and the amount of buffered content (blue). If the Replay buffer is full, the entire bar becomes blue.

- Updated every second.

2 Playback status (▶: play / ⏸: pause / ⏮: rewind / ⏭: fast forward)

3 Time code

Shows you the point in the Replay buffer you are listening to.

- Example: -5:00
 - You are listening to audio that is 5 minutes behind the current broadcast.
- Updated every second.

▣ Replaying content

1 Display the Replay mode screen.

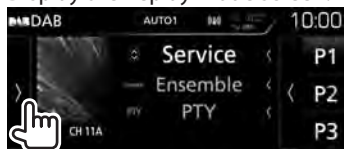

2 Perform the replay operations.



- To start/pause the playback, touch **[▶/⏸]**.
- To rewind/fast forward 15 seconds, touch **[⏮/⏭]**.
- To rewind/fast forward, touch and hold **[⏮/⏭]**.

To return to the live mode screen:

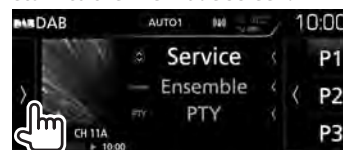

DIGITAL RADIO (DAB)

Settings for Digital Audio Radio

You can set the Digital Radio related items.

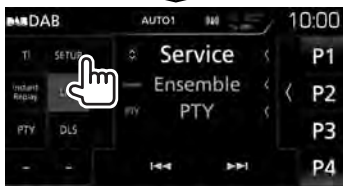
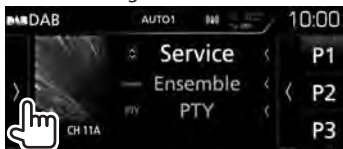

□ Setting items

<p><Priority></p>	<ul style="list-style-type: none"> • ON (Initial): If the same service is provided by Digital Radio during Radio Data System reception, the unit automatically switches to Digital Radio. If the same service is provided by Radio Data System when reception of the service being provided by Digital Radio becomes poor, the unit automatically switches to Radio Data System. • OFF: Deactivates.
-------------------------	--

<p><PTY Watch></p>	<p>If the service of the set program type begins with the ensemble being received, the unit switches from any source to Digital Radio for service reception. Select the type of program.</p>
<p><Announcement Select></p>	<p>If the service of the announcement item you activated begins with the ensemble being received, this unit switches from any source to the announcement received.*1</p> <p>Set [ON] for the announcement items you need.</p> <ul style="list-style-type: none"> • News flash/Transport flash/Warning/Service/ Area weather flash/ Event announcement/ Special event/Programme information/Sport report/ Financial report ↳ To deactivate all announcements, select [All OFF].
<p><Seamless Blend></p>	<ul style="list-style-type: none"> • ON (Initial): Prevents audio break when switching from Digital Radio to Analog Radio. • OFF: Cancels.
<p><Antenna Power>*2</p>	<ul style="list-style-type: none"> • ON (Initial): Supplies power to the DAB aerial. • OFF: Cancels.

<p><L-Band Tuning>*3</p>	<p>If the reception of the service is poor, activate the L-Band reception.</p> <ul style="list-style-type: none"> • ON: Receives the L-Band width during Digital Audio reception. • OFF (Initial): Cancels.
<p><Related Service></p>	<ul style="list-style-type: none"> • ON: When the current selected DAB service network is not available and found the related service, the unit offers to switch to the related service. • OFF (Initial): Cancels.

*1 The volume adjustment while receiving Announcement is automatically memorized. The next time the unit switches to Announcement, the volume is set to the previous level.

*2 You can change the settings only when the unit is in standby. (Page 9)

*3 When the setting is changed, the preset services are initialized.

OTHER EXTERNAL COMPONENTS

Using a camera

- To connect a camera, see page 72.
- To use a rear view camera, a REVERSE lead connection is required. (Page 70)

❑ Settings for the camera

- 1 Display the source/option selection screen. On the Home screen or the source control screen:



- 2 Display the <SETUP> screen.



- 3 Display the <Camera> screen.

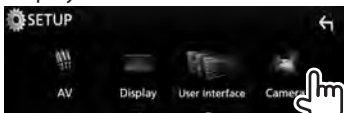

- 4 Configure the camera settings.



- Scroll the page to show more items.

Setting items

[R-CAM Interruption]	<ul style="list-style-type: none"> • ON: Displays the picture from the rear view camera when you shift the gear to the reverse (R) position. • OFF (Initial): Select this when no camera is connected.
[Parking Guidelines]	<ul style="list-style-type: none"> • ON (Initial): Displays the parking guidelines to enable easier parking when you shift the gear to the reverse (R) position. • OFF: Hides the parking guidelines.
[Guidelines Setup]	Adjusts the parking guidelines according to the size of the car, parking space and so on. (See the right column.)
[Front Camera]	<ul style="list-style-type: none"> • ON: Activates the front view camera. Select this to use the front view camera. • OFF (Initial): Select this when no camera is connected.
[Front Camera Mirror Image]	<ul style="list-style-type: none"> • ON: Displays the picture from the front view camera horizontally reversed. • OFF (Initial): Displays the picture from the front view camera as it is.

Adjusting the parking guidelines

- Install the rear view camera in the appropriate position according to the instructions supplied with the rear view camera.
- When adjusting the parking guidelines, make sure to use the parking brake to prevent the car from moving.

- 1 Touch **[Guidelines Setup]** on the <Camera> screen. (See the far left column.) The guidelines settings screen is displayed.
- 2 Touch one of the marks to adjust (1), then adjust the position of the selected mark (2).

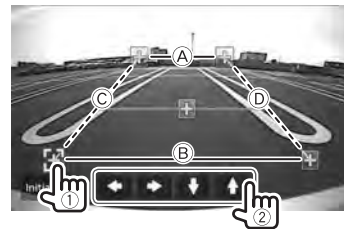

- Make sure that (A) and (B) are horizontally parallel, and that (C) and (D) are the same length.
- Touch **[Initialize]** and after touch **[Yes]** to set all the marks to the initial default position.

OTHER EXTERNAL COMPONENTS

❑ Displaying the picture from the camera

The camera screen is displayed when you shift the gear to the reverse (R) position.



- To erase the operation buttons, touch the screen. Touching the screen again displays the operation buttons.

To display the picture from the camera manually

- When **[Front Camera]** is set to **[ON]**, the picture from the front view camera is displayed. When **[Front Camera]** is set to **[OFF]**, the picture from the rear view camera is displayed.

On the touch panel:

Select **[Camera]** on the pop-up short-cut menu. (Page 13)



On the monitor panel:

DDX9716BTS
DDX9716BTSR



DDX8016DABS



To switch the screen between the front view camera and the rear view camera



- Each time you touch the button, the screen is switched between the rear view screen and the front view screen.

To exit the camera screen



Using external audio/video players—AV-IN

When the operation buttons are not displayed on the screen, touch the area shown on the illustration.

- To change settings for video playback, see page 58.



❑ Starting playback

- 1 Connect an external component. (Page 72)
 - For DDX9716BTS/DDX9716BTSR: Connect an external component to the AV-IN input terminal.
 - For DDX8016DABS: Connect an external component to the AV-IN1 or AV-IN2 input terminal.
- 2 Select the source to play an external component. (Page 12)
 - For DDX9716BTS/DDX9716BTSR: Select **"AV-IN"** as the source.
 - For DDX8016DABS: Select **"AV-IN1"** or **"AV-IN2"** as the source.
- 3 Turn on the connected component and start playing the source.

OTHER EXTERNAL COMPONENTS

Watching a TV (Only for DDX8016DABS)

When the operation buttons are not displayed on the screen, touch the area shown on the illustration.

- To change settings for video playback, see page 58.



Preparation

- Connect the TV tuner box to the AV-IN1 input terminal and TV tuner remote control output terminal. (Page 72)
- Select [ON] for [TV Tuner Control]. (Page 63)

□ Displaying the TV screen

- 1 Select “AV-IN1” as the source. (Page 12)
- 2 Turn on the TV.



[Hide]

Hides the indicators and buttons.



Displays the <Graphic Equalizer> screen. (Page 54)

[TV Ctrl]

Displays the TV control screen.

- [▲]/[▼]: Displays the TV List screen.
- [◀]/[▶]: Displays the Radio List screen.
- [Menu/OK]: Displays the menu or confirms the selection.
- [←]: Restores the TV screen.

130.com.ua

BLUETOOTH

Information for using Bluetooth® devices



Bluetooth is a short-range wireless radio communication technology for mobile devices such as mobile phones, portable PCs, and other devices. Bluetooth devices can be connected without cables and communicate with each other.

Notes

- While driving, do not perform complicated operations such as dialing numbers, using the phone book, etc. When you perform these operations, stop your car in a safe place.
- Some Bluetooth devices may not connect to this unit depending on the Bluetooth version of the device.
- This unit may not work for some Bluetooth devices.
- Connecting conditions may vary depending on your environment.
- For some Bluetooth devices, the device is disconnected when the unit is turned off.

About mobile phones compatible with Phone Book Access Profile (PBAP)

If your mobile phone supports PBAP, you can display the phone book and call lists on the touch panel screen when the mobile phone is connected.

- Phone book: up to 1000 entries
- Dialed calls, received calls, and missed calls: up to 50 entries in total

Connecting Bluetooth devices

❑ Activating/deactivating the Bluetooth function

When you use the Bluetooth device, activate the Bluetooth function on the unit.

- 1 Display the source/option selection screen. On the Home screen or the source control screen:



- 2 Display the <SETUP> screen.



- 3 Display the <Bluetooth Setup> screen.



- 4 Activate ([ON]) or deactivate ([OFF]) the Bluetooth function.



❑ Registering and connecting a new Bluetooth device

When you connect a Bluetooth device to the unit for the first time, pair the unit and the device. Pairing allows Bluetooth devices to communicate with each other.

- You cannot register the Bluetooth device when you are using the following sources: “**Bluetooth**”, “**iPod**”, “**Android Auto**”, or “**Apple CarPlay**”. If you want to register the Bluetooth device while using one of the above mentioned sources, send the connection request from the Bluetooth device and register it.
- The pairing method differs depending on the Bluetooth version of the device.
 - For devices with Bluetooth 2.1: You can pair the device and the unit using SSP (Secure Simple Pairing) which only requires confirmation.
 - For devices with Bluetooth 2.0: You need to enter a PIN code both on the device and unit for pairing.
- You can register up to 10 devices in total.
- Two Bluetooth devices can be connected at a time.
- To use the Bluetooth function, you need to turn on the Bluetooth function of the device.
- When a Bluetooth mobile phone is connected, the signal strength and battery level are displayed when the information is acquired from the device.

BLUETOOTH

Auto pairing

When <Auto Pairing> is set to [ON], iOS devices (such as iPhone) are automatically paired when connected via USB. (Page 49)

Pairing a Bluetooth device from the target device

- 1 Search for the unit (“DDX****”) from your Bluetooth device and operate the device to register.

For a Bluetooth device compatible with SSP (Bluetooth 2.1):

Confirm the request both on the device and the unit.



- Touch [No] to reject the request.

For a Bluetooth device compatible with Bluetooth 2.0:

Select the unit (“DDX****”) on your Bluetooth device.

- If a PIN code is required, enter the PIN code shown on the screen (initial: “0000”).
 - To change PIN code, see page 43.



- 2 Determine usage as a mobile phone.



- To use the Bluetooth device as a mobile phone, select the hands free number ([Hands Free1] or [Hands Free2]) to connect the device for.
- When you do not want to use the Bluetooth device as a mobile phone, select [No Connection.].
- To close the window, touch [Close].

- 3 When your Bluetooth device is compatible with A2DP or SPP: Determine usage as an audio player or a device with Apps installed.



- To use the device as an audio player, touch [Yes].
 - When you do not want to use the Bluetooth device as an audio player, touch [No].
- 4 When your Bluetooth device is compatible with PBAP: Select whether to transfer the phonebook of your Bluetooth device to the unit or not.



- To transfer the phone book from your Bluetooth device, touch [Yes].
- When you do not want to transfer the phone book, touch [No].

BLUETOOTH

❑ Connecting/disconnecting a paired Bluetooth device

Two devices can be connected simultaneously.

- 1 Display the source/option selection screen. On the Home screen or the source control screen:



- 2 Display the <SETUP> screen.



- 3 Display the <Bluetooth Setup> screen.



- 4 Display the <Select Device> screen.



- 5 Select the device you want to connect/disconnect.



- Scroll the page to show more items.
- The icons beside the paired device indicate the following:
 - 📱: Connected as a mobile phone.
 - 🎵: Connected as an audio player.

- 6 Select the usage of the device.

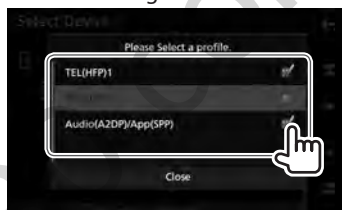

Each time you touch the selection, the usage is selected ("✓" appears) or deselected ("✓" disappears). Select to connect and deselect to disconnect the device.

- [TEL (HFP)1]/[TEL (HFP)2]: Mobile phone
- [Audio (A2DP)/App (SPP)]: Audio player/device with Apps installed
- To close the window, touch [Close].

❑ Deleting a paired Bluetooth device

- 1 Display the <Select Device> screen. (See the far left column.)
- 2 Display the <Device Remove> screen.



- 3 Select a device to delete (①), then touch [Delete] (②).



- Touch [All] to select all devices.
 - Touch [All] to deselect all selected devices.
 - Scroll the page to show more items.
- A confirmation message appears. Touch [Yes].

BLUETOOTH

❑ Changing the PIN code

- 1 Display the <Bluetooth Setup> screen.
(Page 42)
- 2 Display the PIN code input screen.



- 3 Enter the PIN code (①), then confirm the entry (②).



- Touch [**BS**] to delete the last entry.

❑ Change the device name of the unit displayed on the paired device

- 1 Display the <Bluetooth Setup> screen.
(Page 42)
- 2 Display the device name entry screen.



- 3 Enter the device name (①), then confirm the entry (②).



- Touch [**BS**] to delete the last entry.
- Touch [**↩/⏪**] to move the entry position.

Using a Bluetooth mobile phone

❑ Receiving a call

When a call comes in...



- Call information is displayed if acquired.
- The call incoming screen is not displayed while the camera screen is displayed. To display the call incoming screen, shift the gear to the drive position.
 - Only for DDX8016DABS: You can also display the call incoming screen while the camera screen is displayed by pressing and holding the Volume/MENU/TEL knob on the monitor panel.

To reject a call



When <Auto Response> is activated (Page 49)
The unit answers incoming calls automatically.

BLUETOOTH

❑ Ending a call

While talking...

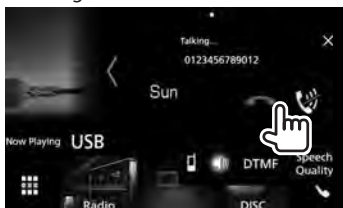

❑ Adjusting the volume during a call/ echo cancel level/noise reduction volume

- 1 Display the <Speech Quality> window.
While talking...

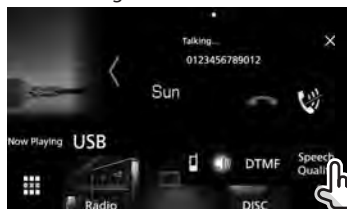

2

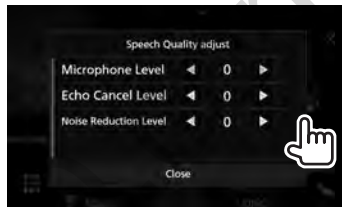

<Microphone Level> Adjusts the microphone volume level.

- -10 to +10 (initial: 0).

<Echo Cancel Level>* Adjusts the echo volume.

- -5 to +5 (initial: 0).

<Noise Reduction Level>* Adjusts the noise reduction volume.

- -5 to +5 (initial: 0).

- To close the window, touch [Close].

* You can also adjust these items on the <TEL SETUP> screen.

(Page 49)

❑ Switching between handsfree mode and phone mode

While talking...



Each time you touch the button, the talking method is switched (☎ : handsfree mode / 📞 : phone mode).

BLUETOOTH

❑ Switching between two connected devices

When two devices are connected, you can change the device to use.

While using a Bluetooth mobile phone, select the device you want to use.

- 1 Display the phone control screen.
On the Home screen or the source control screen:



- 2 Select the device to use.

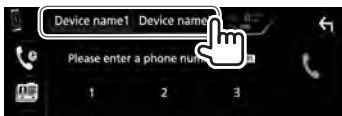

The active device is highlighted.

❑ Muting the volume of the microphone

While talking...



To restore the volume, touch [🔊].

❑ Sending dial tone during a call

You can send dial tone during a call using the DTMF (Dual Tone Multi Frequency) function.

- 1 Display the tone input window.
While talking...



- 2 Input the tone to send.



- To close the window, touch [Close].

❑ Making a call

- 1 Display the phone control screen.
On the Home screen or the source control screen:



- Only for DDX8016DABS: You can also display the phone control screen by pressing and holding the Volume/MENU/TEL knob on the monitor panel.

- 2 Select a method to make a call.



- [📞] From the call history*
- [📖] From the phone book*
- [★] From the preset list
 - To preset, see page 47.
- [📠] Direct number entry
- [📞] Voice dialing

- You can display the <Bluetooth Setup> screen by touching [📶].

* When the mobile phone is not compatible with Phone Book Access Profile (PBAP), the phone book is not displayed.

BLUETOOTH

From the call history missed calls/ received calls/ dialed calls

Display the call history list (1), then select the target to make a call (2).



- Scroll the page to show more items.

From the phonebook

- To transfer phonebook from the connected Bluetooth mobile phone compatible with PBAP, see page 48.

1 Display the phonebook (1), then display the keyboard to search by initial (2).



2 Select the initial to sort the list in the alphabetical order.



- If the initial character is a number, touch [1] and then select the number.
- Touch [⌫] to delete the last entry.
- Touch [X] to hide the keyboard.

3 Select a contact to call.



- Scroll the page to show more items.

4 Select the phone number from the list to make a call.



- Scroll the page to show more items.
- You can select a first name or last name to use when sorting the list in alphabetical order on the <TEL SETUP> screen. (Page 49)

From the preset list

Display the preset list (1), then select the target to make a call (2).

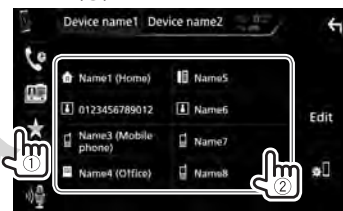

Direct number entry

Display the direct number entry screen (1), enter the number (2), then make a call (3).



BLUETOOTH

Voice dialing

- Available only when the connected mobile phone has a voice recognition system.

1 Activate voice dialing.



- You can also activate voice dialing by holding **VOICE** on the monitor panel.

2 Say the name of the person you want to call.



- If the voice command is not recognized, touch **[Restart]**, then say the name again.

To cancel voice dialing: Touch **[Stop]**.

❑ Presetting phone numbers

You can preset up to 10 phone numbers.

1 Display the preset list. (Page 45)

2



3 Select a position to store into.



4 Select a method to add a phone number to preset list, then register the number to the preset list.



[Add number from phonebook]
[Add number direct]

Select a phone number from the phonebook (Page 46).

Enter a phone number on the direct number entry screen, then touch **[Set]** to add to the preset list.

- To close the window, touch **[Close]**.

- To display the preset list, touch **[★]** on the phone control screen.

To delete a phone number from the preset list:

Select the phone number to delete on the **<Edit Preset Dial>** screen, then touch **[Delete]** on the **<Edit Preset Number>** window.

To delete all phone numbers from the preset list:

Touch **[Delete all]** on the **<Edit Preset Dial>** screen.

BLUETOOTH

❑ Editing phonebook

To transfer the phonebook

If the connected Bluetooth mobile phone is compatible with Phone Book Access Profile (PBAP), you can transfer the phonebook of the mobile phone to the unit.

- 1 Display the phone book (①), then display the <Edit Phonebook> window (②).

On the phone control screen:



- 2 Start transferring the phonebook.

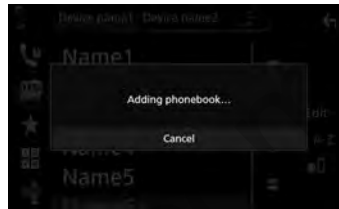

- To close the <Edit Phonebook> window, touch [Close].
- To cancel the transferring the phonebook, touch [Cancel].

To delete contact from the phonebook

- 1 Display the <Edit Phonebook> window. (See the far left column.)
- 2 Display the <Delete Phonebook> screen.

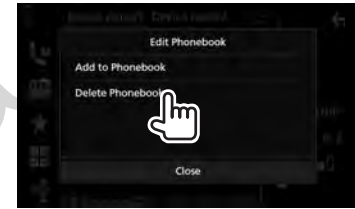

- To close the window, touch [Close].
- 3 Select contacts to delete (①), then delete them (②).

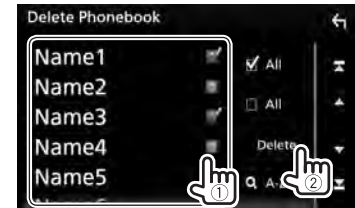

- “✓” appears beside the selected bookmarks.
- Touch [All] to select all bookmarks.
- Touch [All] to deselect all selected bookmarks.
- Touch [Q A-Z] to search the contact by initial.
- Scroll the page to show more items.

BLUETOOTH

Settings for Bluetooth mobile phone

You can change various settings for using Bluetooth mobile phones on the <TEL SETUP> screen.

1 Display the <Bluetooth Setup> screen. (Page 42)

2 Display the <TEL SETUP> screen.



- You can also display the <Bluetooth Setup> screen by touching [**#**] on the phone control screen. (Page 45)



3 Configure the Bluetooth settings (①), then confirm the adjustments (②).



- Scroll the page to show more items.

Setting items

<Bluetooth HF/Audio>	Select the speakers used for Bluetooth (both phone and audio player). <ul style="list-style-type: none"> Front: Front speakers only. All (Initial): All speakers.
<Auto Response>	<ul style="list-style-type: none"> 1 – 30 (in 5 second steps): The unit answers the incoming calls automatically. Set the calling ring time (seconds). OFF (Initial): The unit does not answer the calls automatically. Answer the calls manually.
<Auto Pairing>	<ul style="list-style-type: none"> ON (Initial): Establishes pairing automatically with the connected iOS device (such as iPhone) even if the Bluetooth function is deactivated on the device. (Auto pairing may not work for some devices depending on the iOS version.) OFF: Cancels.
<Sort Order>	Select a first name or last name to use when sorting the list in alphabetical order. <ul style="list-style-type: none"> First: Sorts the list in the order of first name. Last (Initial): Sorts the list in the order of last name.
<Echo Cancel Level>	Adjusts the echo volume. <ul style="list-style-type: none"> -5 to +5 (initial: 0).
<Noise Reduction Level>	Adjusts the noise reduction volume. <ul style="list-style-type: none"> -5 to +5 (initial: 0).

Using the Bluetooth audio player

- To connect a new device, see page 40.
- To connect/disconnect a paired device, see page 42.

Indications and buttons on the source control screen



- The operation buttons, indications and information displayed on the screen differ depending on the connected device.

Playback information

- The information displayed on the screen differs depending on the connected device.
 - Connected device name
 - Playback mode (Page 50)
 - Signal strength and battery level (only when the information is acquired from the device)
 - Tag data (current track title/artist name/album title)*
 - Touching [**<**] scrolls the text if not all of the text is shown.
 - Artwork (Shown if the track contains artwork)

* Available only for devices compatible with AVRCP 1.3.

Continued on the next page...

BLUETOOTH

Operation buttons

- Available buttons on the screen and operations differ depending on the connected device.

- [] Displays the other operation button window.
- [] Selects Repeat playback mode.
- []: Repeats the current track/file.
 - []: Repeats all tracks/files in the current folder.
 - [] ALL: Repeats the all tracks/files in the device.
- []*1 Selects Random playback mode.
- []: Randomly plays all tracks in current folder.
 - [] ALL: Randomly plays all tracks in current album.
- [] Displays the <Graphic Equalizer> screen. (Page 54)
- [Q]*2 Displays the folder/track list. (See the right column.)
- [] [] Selects a track. (Touch)
- Reverse/forward search.*3 (Hold)
- [] Starts playback.
- [] Pauses playback.

[BT DEVICE CHANGE] Switches the Bluetooth audio player.

- To display all available operation buttons, touch [] to display the other operation button window.

*1 To cancel random mode, touch the button repeatedly until it is grayed out.

*2 Available only for devices compatible with AVRCP 1.5.

*3 Available only for devices compatible with AVRCP 1.3.

□ Selecting a track from the list

- 1 Display the music list screen.



- 2 Select the folder, then the item in the selected folder.

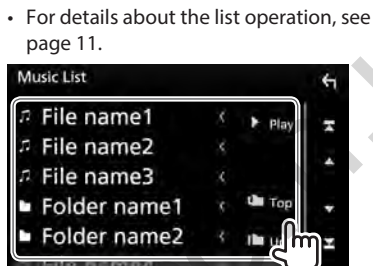

- For details about the list operation, see page 11.

□ Switching the Bluetooth audio player

- 1 Display the Bluetooth device selection window.

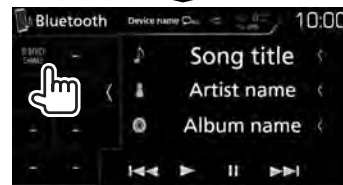
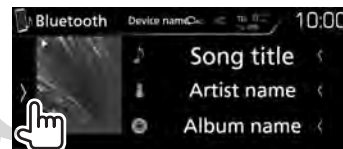

Available Bluetooth audio player devices are listed.

- 2 Select the desired device.

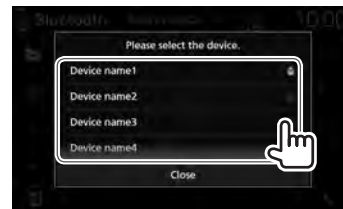

- To close the window, touch [Close]. The selected device is connected.

SETTINGS

Settings for using applications of iPod/iPhone/Android/BlackBerry

Before using applications of iPod/iPhone/Android/BlackBerry, select the device to use and connection method.

Preparation:

Connect iPod touch/iPhone/Android/BlackBerry device.

- **For Android/BlackBerry:** Connect the Android/BlackBerry device via Bluetooth or both with a cable and via Bluetooth.
 - For Bluetooth connection, see page 40.
 - For wired connection, see page 72.
- **For iPod touch/iPhone:** Connect iPod touch/iPhone with a cable, via Bluetooth, or both with a cable and via Bluetooth. (Page 21)

- 1 Display the source/option selection screen. On the Home screen or the source control screen:



- 2 Display the <SETUP> screen.



- 3 Display the <AV> screen.

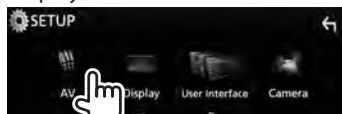

- 4 Set [Automotive Mirroring] to [OFF].

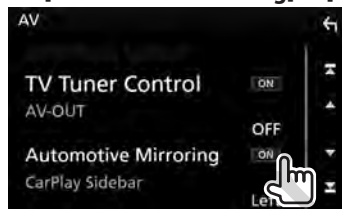

- 5 Display the <APP/iPod SETUP> screen.



- 6 Select the device and connection method for <APP Connection select>.

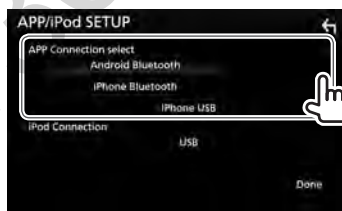

<Android Bluetooth>

Select this to use Apps with an Android device connected via Bluetooth.

<iPhone Bluetooth>

Select this to use Apps with iPod/iPhone connected via Bluetooth.

<iPhone USB>

Select this to use Apps with iPod/iPhone connected using KCA-iP102 (optional accessory) or KCA-iP103 (optional accessory).

- 7 Finish the procedure.



SETTINGS

Selecting different sources for the front and rear monitors—Zone Control

You can select different sources for both this unit and an external monitor connected to the VIDEO OUT and AV-OUT AUDIO terminals. (Page 72)

- 1 Display the source/option selection screen. On the Home screen or the source control screen:



- 2 Display the <Audio> screen.



- You can also display the <Audio> screen by selecting [Audio] on the pop-up short-cut menu. (Page 13)



- 3 Display the <Zone Control> screen.



- 4 Select the source for front and rear, and adjust the volume for the rear source.



[Zone Select] Selects whether different sources are selected for the front and rear monitors.

- **Dual Zone:** Selects different sources. (The DUAL indicator lights up.)
- **Single Zone:** Selects the same source.

[Front Source]* Selects the source for the front monitor.

[Rear Source]* Selects the source for the rear monitor.

[Rear VOL.]* Adjusts the volume for the rear source.

- When the rear speaker sound is switched, the audio source that is output at the AV-OUT AUDIO terminal is also switched to the same source.

- When [Zone Control] is set to [Dual Zone], the following operations/performances are not available.
 - Output from the subwoofer
 - Adjustment on the <Graphic Equalizer> screen (Page 54)
 - Adjustment on the <Sound Effect> screen (Page 58)
 - Settings on the <Speaker Select> screen (Page 53)
 - Settings on the <Position/DTA> screen (Page 55)
- You cannot select iPod if it is connected via Bluetooth.
- If you select USB, iPod, Disc, Bluetooth audio, Apple CarPlay or Android Auto as the Front Source, you cannot select USB or iPod as the Rear Source.

* Selectable only when [Zone Select] is set to [Dual Zone].

SETTINGS

Sound adjustment—Audio

You can adjust the various audio settings on the **<Audio>** screen.

- You cannot change the **<Audio>** settings screen in the following situations:
 - When the unit is in standby (Page 9)
 - When the Bluetooth phone is used (making or receiving a call, during a call, or while voice dialing)

Setting the car type/speakers/crossover frequency

- 1 Display the source/option selection screen. On the Home screen or the source control screen:



- 2 Display the **<Audio>** screen.



- You can also display the **<Audio>** screen by selecting **[Audio]** on the pop-up short-cut menu. (Page 13)



- 3 Display the **<Speaker Select>** screen.

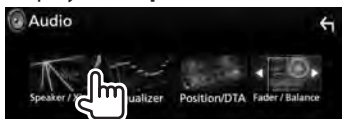

- 4 Select a car type.

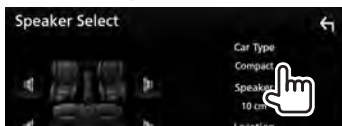

A selection window appears for car type. Select an item, then touch **[Close]** to close the window.

- 5 Select a speaker (front speakers, rear speakers, or subwoofer) to set (①), then location and speaker/tweeter size of the selected speaker (②).

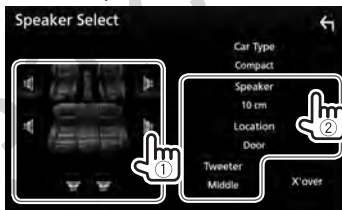

A selection window appears for location and speaker/tweeter setting. Select an item, then touch **[Close]** to close the window.

- Repeat steps ① and ② to set all speakers.
- When a speaker is not connected, select **[None]**.
- When setting the front speakers, also select the speaker size for **<Tweeter>**.

- 6 Display the **<X'over>** screen (①), select the speaker type (②), then adjust the crossover frequency of the selected speaker (③).

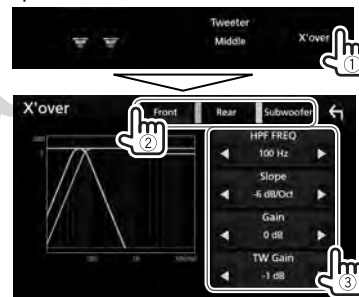

<HPF FREQ> Adjusts the crossover frequency for the front or rear speakers (high pass filter).^{*1}

<LPF FREQ> Adjusts the crossover for the subwoofer (low pass filter).^{*2}

<Slope> Adjusts the crossover slope.^{*3}

<Gain> Adjusts the output volume of the selected speaker.

<TW Gain> Adjusts the output volume of the tweeter.^{*4 *5}

<Phase Inversion> Selects the phase for the subwoofer.^{*2}

^{*1} Appears only when the front or rear speakers are selected.

^{*2} Appears only when the subwoofer is selected.

^{*3} Not adjustable when **<HPF FREQ>** or **<LPF FREQ>** is set to **<Through>**.

^{*4} Appears only when the front speakers are selected.

^{*5} Adjustable only when **<Tweeter>** is set to **<Small>**, **<Middle>**, or **<Large>** on the **<Speaker Select>** screen.

SETTINGS

❑ Using the sound equalization

- The adjustment is memorized for each source until you adjust the sound again. If the source is a disc, the adjustment is stored for each of the following categories.
 - DVD-Video
 - CD/VCD/Audio files/Video files (Page 75)
- You cannot adjust the sound when the unit is in standby.

Selecting a preset sound mode

- 1 Display the **<Audio>** screen. (Page 53)
- 2 Display the **<Graphic Equalizer>** screen.



- You can also display the **<Graphic Equalizer>** screen by touching [EQ] on the source control screen.

- 3 Display the preset sound modes (①), then select a sound mode (②).

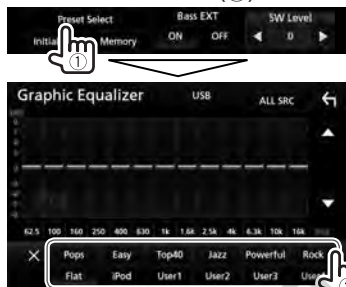

- Touch [X] to hide the preset sound modes.

Storing your own adjustments—Adjusting the sound precisely

- 1 Display the **<Graphic Equalizer>** screen. (See the left column.)
- 2 Select a band and adjust the level of the selected band.
 - You can adjust the level by dragging the slider or using [▲]/[▼].
 - Repeat this step to adjust the level of other bands.

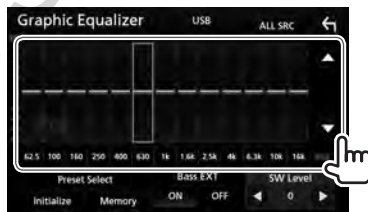

- 3 Activate ([ON]) or deactivate ([OFF]) the bass (**<Bass EXT>**) (①), and then adjust the subwoofer level (**<SW Level>**)* (②).



- Touch [◀/▶] to adjust **<SW Level>**.
 - When **<Bass Ext>** is set to [ON], a frequency lower than 62.5 Hz is set to the same gain level as 62.5 Hz.
- 4 Store the adjustment.

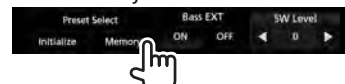

A user selection window appears. Select from [User 1] to [User 4] to store your adjustment, then touch [Close] to close the window.

- To apply the adjusted equalizer to all playback source, touch [ALL SRC] on the **<Graphic Equalizer>** screen, then touch [OK] to confirm.
- To make the current EQ curve flat, touch [Initialize].

* Not adjustable when **<None>** is selected for subwoofer on the **<Speaker Select>** screen. (Page 53)

SETTINGS

❑ Setting the listening position

You can adjust the sound effects according to your listening position.

- 1 Display the <Audio> screen. (Page 53)
- 2 Display the <Position/DTA> screen.



- 3 Touch [Listening Position] (①), then select the listening position ([Front L], [Front R], [Front All], or [All]) (②).



Adjusting the Digital Time Alignment (DTA)

Make fine adjustments to the delay time of the speaker output to create a more suitable environment for your vehicle.

- 1 Display the <Position/DTA> screen. (See the left column.)
- 2 Display the DTA adjustment screen.



- 3 Touch [Delay] (①), then adjust the Digital Time Alignment (DTA) value for each speaker (②).



- Touch [◀/▶] to adjust the value.
- To return to the initial setting of Delay and Level, touch [Initialize] and [YES] in the confirmation screen.

- 4 Touch [Level] (①), then adjust the output volume for each speaker (②).

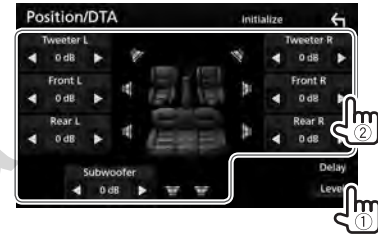

- Touch [◀/▶] to adjust the level.
- To return to the initial setting of Delay and Level, touch [Initialize] and [YES] in the confirmation screen.

SETTINGS

❑ Localizing the sound image—Front Focus

You can localize the sound image in front of the selected seat.

- 1 Display the <Position/DTA> screen. (Page 55)
- 2 Touch **[Front Focus]** (①), then select the listening position to set as the front position (②).



- When you are sitting on the **[Front All]** (front seats) or **[All]** (front and rear seats) position, select left (“**Priority L**”) or right (“**Priority R**”) to specify the position to localize the sound image.

- 3 Display the <Front Focus Adjust> screen.



- 4 Touch **[Delay]** (①), then adjust the sound image precisely (②).

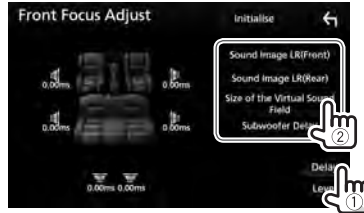

- [Sound Image LR (Front)]** Adjusts the sound image to set on the front position.
- [Sound Image LR (Rear)]** Adjusts the sound image to set on the rear position.
- [Size of the Virtual Sound Field]** Adjusts the virtual sound field to the desired field size.
- If the sound image moves out of the front position, adjust **[Sound Image LR (Front)]**/**[Sound Image LR (Rear)]**.
- [Subwoofer Delay]** Adjusts the time alignment of the subwoofer.

- To return to the initial setting of Delay and Level, touch **[Initialize]** and **[YES]** in the confirmation screen.

- 5 Touch **[Level]** (①), then adjust the output volume for each speaker (②).

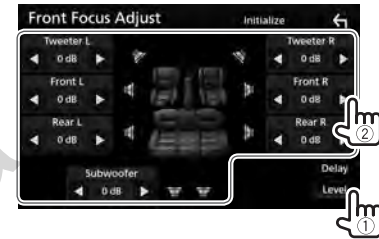

- Touch **[<|>]** to adjust the level.
- To return to the initial setting of Delay and Level, touch **[Initialize]** and **[YES]** in the confirmation screen.

SETTINGS

❑ Adjusting the volume balance

- 1 Display the <Audio> screen. (Page 53)
- 2 Display the <Fader/Balance> screen.

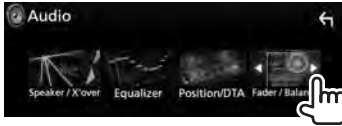

- 3 Adjust the volume balance.

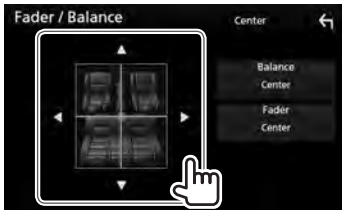

- Touch [▲]/[▼] to adjust the front and rear speaker output balance.
- Touch [◀]/[▶] to adjust the left and right speaker output balance.
- You can also make adjustments by dragging the cursor.
- To clear the adjustment, touch **[Center]**.

❑ Adjusting the volume output according to different sources

You can adjust and store the auto-adjustment volume level for each source. The volume level will automatically increase or decrease when you change the source.

- 1 Display the <Audio> screen. (Page 53)
- 2 Display the <Volume Offset> screen.



- 3 Adjust the volume output level for each source.

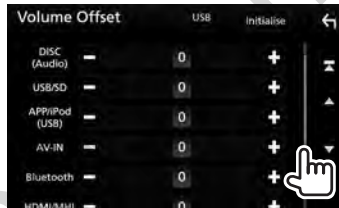

- Scroll the page to show more items.
- To initialize the setting value, touch **[Initialize]**.
- If you have increased the volume first, then reduced the volume using the Volume Offset, the sound generated if you suddenly switch to another source may be extremely loud.

SETTINGS

□ Adjusting the sound effect

- 1 Display the <Audio> screen. (Page 53)
- 2 Display the <Sound Effect> screen.



- 3 Adjust each item.



<Bass Boost>

Selects the bass boost level.

- **OFF (Initial)/1/2/3**

<Loudness>

Adjusts loudness. (The LOUD indicator lights up when the loudness is adjusted.)

- **OFF (Initial)/Low/High**

<Drive Equalizer>

Reduces the driving noise by raising the bandwidth.

- **OFF (Initial)/ON**

<Space Enhancer>*1

Virtually enhances the sound space using the Digital Signal Processor (DSP) system. Select the enhance level.

- **OFF (Initial)/Small/Medium/Large**

<Supreme>

Restores the sound lost due to audio compression to a realistic sound.

- **OFF/ON (Initial)**

<Realizer>

Virtually makes the sound more realistic using the Digital Signal Processor (DSP) system. Select the sound level.

- **OFF (Initial)/1/2/3**

<Stage EQ>

You can move the center of the sound to the lower or higher point. Select the height.

- **OFF (Initial)/Low/Middle/High**

*1 You cannot change the setting when "Radio" is selected as the source.

Adjustment for video playback

- 1 Display the pop-up short-cut menu.
DDX9716BTS **DDX8016DABS**
DDX9716BTSR



- 2 Display the picture adjustment screen.



- 3 Adjust the picture.



SETTINGS

- <Backlight>** Adjusts the brightness of the backlight. (-4 to +4)
- <Contrast>** Adjusts the contrast. (-4 to +4)
- <Black>** Adjusts the blackness. (-4 to +4)
- <Brightness>** Adjusts the brightness. (-4 to +4)
- <Colour>** Adjusts the color. (-4 to +4)
- <Tint>** Adjusts the tint. (-4 to +4)
- <Aspect>** Selects the aspect ratio.

- **Full:** Displays the picture fully. The aspect ratio is changed if necessary.
- **Normal:** Display the picture in the aspect ratio of 4:3.
- **Auto:** Displays the picture by selecting the appropriate aspect ratio automatically. (DISC)
Displays the picture fully in the original aspect ratio. (USB)

- Adjustable items are different depending on the current source.
- The image quality can be set for each source. Backlight and Black are common to all sources.

Changing the display design

Customizing the panel color

- 1 Display the source/option selection screen. On the Home screen or the source control screen:



- 2 Display the <SETUP> screen.



- 3 Display the <Display> screen.



- 4 Display the <Panel Colour Coordinate> screen.

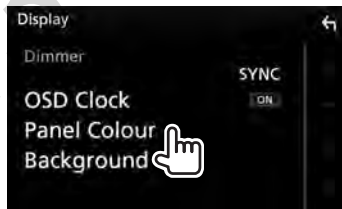

- 5 Select a panel color.

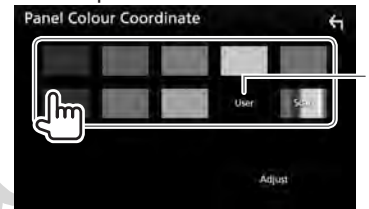

- Selecting [Scan] changes the illumination color gradually.

- * Store your own color adjustment beforehand. (See below.)

Making your own color adjustment

- 1 Display <Panel Colour Coordinate> screen. (See the left column.)

- 2



- 3 Adjust the color.



The adjustment is stored in [User].

SETTINGS

❑ Customizing the background

- 1 Display the <Display> screen. (Page 59)
- 2 Display the <Background> screen.



- 3 Select a background.

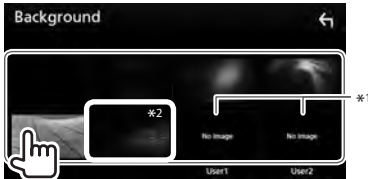

*1 Store your own scene beforehand. (See the right column.)

*2 The color you have selected at **[Panel Colour]** is added on the image. If you select "Scan" at **[Panel Colour]**, you cannot select this image.

❑ Storing your favorite image for the background

You can set your favorite image stored on the connected USB device.

- Use a JPEG file with a resolution of 800 x 480 pixels.
- The color of the captured image may look different from that of the actual scene.

- 1 Connect the USB device on which the image is stored. (Page 71)
- 2 Display the <Background> screen. (See the left column.)
- 3 Select **[User1 Select]** or **[User2 Select]** to store the image for.



- 4 Select the folder, then the file for the background image in the selected folder.



- Scroll the page to show more items.

- 5 Rotate the image if necessary (①), then confirm the selection (②).

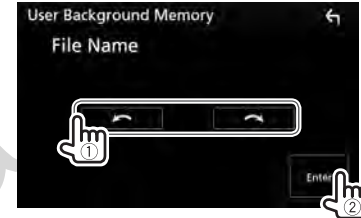

Touch **[Enter]** to store the new image. (The existing image is replaced with the new one.)

SETTINGS

Customizing the system settings

❑ Memorizing/recalling the settings

- You can memorize the settings changed in the <Audio> screen and recall the memorized settings any time.
- The memorized settings are kept even when the unit is reset.
- You cannot perform the operation when [SETUP Memory] is set to [Lock]. Unlock the setting beforehand.

- 1 Display the source/option selection screen. On the Home screen or the source control screen:



- 2 Display the <SETUP> screen.



- 3 Display the <Special> screen.



- 4 Select an option.



- [Audio SETUP Memory] Memorizes the current audio setting.
- [Audio SETUP Recall] Recalls the memorized audio setting.
- [Audio SETUP Clear] Clears the AUDIO SETUP Memory and the currently memorized audio setting.

A confirmation message appears. Touch [Yes].

❑ Locking the settings

You can lock the settings for <Audio> to prevent them from being changed.

- 1 Display the <Special> screen. (See the far left column.)
- 2 Select [Lock] to lock the settings.



To unlock the setting: Touch [SETUP Memory] to select [Unlock].

SETTINGS

❑ Adjusting the touch position

You can adjust the touch position on the touch panel if the position touched and the operation performed do not match.

- 1 Display the source/option selection screen. On the Home screen or the source control screen:



- 2 Display the <SETUP> screen.



- 3 Display the <User Interface> screen.

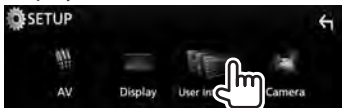

- 4 Display the <Touch Panel Adjust> screen.



- 5 Touch the center of the marks at the lower left and at the upper right as instructed.

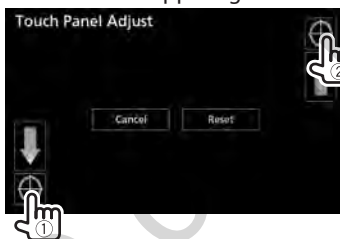

- To reset the touch position, press [**Reset**].
- To cancel the current operation, press [**Cancel**].

Setting menu items—SETUP

❑ Displaying the <SETUP> menu screen

- 1 Display the source/option selection screen. On the Home screen or the source control screen:



- 2 Display the <SETUP> screen.



- You can also display the <SETUP> screen by selecting [**SETUP**] on the pop-up short-cut menu. (Page 13)



SETTINGS

<AV> setting screen

[APP/iPod SETUP]

- **APP Connection select:** Select the device and connection method. (Page 51)
- **iPod Connection:** Select the connection method of iPod/iPhone. (Page 21)

[TV Tuner Control]*¹

- **ON:** Enables control of TV operation on “AV-IN1”.
- **OFF** (Initial): Select this to use “AV-IN1” with components other than TV Tuner.

[AV-OUT]

You can determine the use of the external component connected to the VIDEO OUT/ AV-OUT AUDIO terminal.

- **OFF** (Initial)//AV-IN/AV-IN1//AV-IN2/DISC/USB/iPod

[Automotive Mirroring]

Select the usage of the iPhone compatible with CarPlay. (Page 25)

- **ON** (Initial): Allows “Apple CarPlay”^{*2}, “Android Auto”^{*3} to be selected on the Home screen.
- **OFF:** Cancels.

[CarPlay Sidebar]

Select the position of the control bar (left or right) shown on the touch panel.

- **Left** (Initial)/**Right**

*¹ Only for DDX8016DABS.

*² “Apple CarPlay” is displayed as the source on the Home screen when iPhone compatible with CarPlay is connected.

*³ Only for DDX9716BTS/DDX9716BTSR.

<Display> setting screen

[Dimmer]

- **ON:** Activates dimmer.
- **OFF:** Cancels.
- **SYNC** (Initial): Dims the screen and button illumination when you turn on the headlights.

[OSD Clock]

Select if you want to display the clock while watching DVD video, etc.

- **ON** (Initial)/**OFF**

[Panel Colour]

Change the panel color. (Page 59)

[Background]

Change the background design. (Page 60)

<User Interface> setting screen

[Steering Remote Controller]*¹

Assign functions to the keys on the remote controller of the steering wheel. (Page 67)

[Beep]

- **ON** (Initial): Activates the key-touch tone.
- **OFF:** Cancels.

[Vehicle Adaptor Information]*²

- **ON** (Initial): Activates the vehicle information display function.
- **OFF:** Cancels.

[Beep for parking distance control]*²

- **ON:** Activates a warning tone when the onboard proximity sensor detects a human or object in the vehicle’s path while parking.
- **OFF** (Initial): Cancels.

[Parking Distance Display]*²

When an commercial adapter is connected to the External I/F terminal (Page 72), you can display information about obstacles around the car.

- **ON:** Always displays information.

- **Dyn.** (Initial): Displays information when the sensor detects obstacles.
- **OFF:** Cancels.

[Parking Distance Position]*²

Select where information about obstacles is displayed on the screen.

- **Left/Right** (Initial)

[Language Select]

Select the text language used for on-screen information.

American English (en)/British English (en)

(Initial for DDX9716BTS/DDX8016DABS)/

Nederlands (nl)/Français (fr)/Deutsch (de)/

Italiano (it)/Español (es)/(ar) العربية/

Ελληνικά (el)/Português (pt)/Čeština (cs)/

Polski (pl)/Magyar (hu)/Русский (ru) (Initial for

DDX9716BTSR)/தமிழ் (th)/Türkçe (tr)/中文 (zh)/

(he) עברית (fa) فارسی/Bahasa Melayu (ms)/Bahasa

Indonesia (id)

[Touch Panel Adjust]

Adjust the touch positions of the buttons on the screen. (Page 62)

[Clock]

Select the method to set the clock. (Page 6)

[Time Zone]

Select the time zone to synchronize the clock with the GPS. (Page 6)

[Clock Adjust]*³

Adjust the clock manually. (Page 6)

*¹ Only for DDX8016DABS.

*² The setting is available when a commercial adapter is connected to the External I/F terminal (Page 72). Consult your Kenwood dealer for details.

*³ Available when [Clock] is set to [Manual].

SETTINGS

<Camera> setting screen

[R-CAM Interruption]

- **ON:** Displays the picture from the rear view camera when you shift the gear to the reverse (R) position.
- **OFF** (Initial): Select this when no camera is connected.

[Parking Guidelines]

- **ON** (Initial): Displays the parking guidelines to enable easier parking when you shift the gear to the reverse (R) position.
- **OFF:** Hides the parking guidelines.

[Guidelines Setup]

Adjust the parking guidelines. (Page 36)

[Front Camera]

- **ON:** Activates the front view camera. Select this to use the front view camera.
- **OFF** (Initial): Select this when no camera is connected.

[Front Camera Mirror Image]

- **ON:** Displays the picture from the front view camera horizontally reversed.
- **OFF** (Initial): Displays the picture from the front view camera as it is.

<Special> setting screen

[DEMO]

- **ON** (Initial): Activates the demonstration on the screen.
- **OFF:** Cancels.

[SETUP Memory]

Locks or unlocks the Audio SETUP Memory/Recall/Clear. (Page 61)

[Audio SETUP Memory]

Memorizes the current audio setting. (Page 61)

[Audio SETUP Recall]

Recalls the memorized audio setting. (Page 61)

[Audio SETUP Clear]

Clears the AUDIO SETUP Memory and the currently memorized audio setting. (Page 61)

[Software Information]

Display the version information of the software. You can update the software.

[Open Source Licenses]

Show the Open Source Licenses.

[Initialize]

Touch **[Initialize]** and then touch **[Yes]** to set all the settings to the initial default settings.

* Audio SETUP Memory is not initialized.

<Bluetooth> setting screen

[Bluetooth]

- **ON** (Initial): Activates the Bluetooth function of the unit.
- **OFF:** Cancels.

[Select Device]

Connect or disconnect the paired device. (Page 42)

[Device Name]

Display/change the device name to be shown on the Bluetooth device. (Page 43)

[PIN Code]

Change the PIN code of the unit. (Page 43)

[Device Address]

Display the device address of the unit.

[TEL SETUP]

Configure the setting for using a Bluetooth mobile phone. (Page 49)

<Security> setting screen

[SI]

- **ON** (Initial): Activates the security function.
- **OFF:** Cancels.

[Security Code Set]

Register the security code for the unit. (Page 4)

[Security Code Cancellation]

Clear the security code. (Page 4)

[Security Code Change]

Change the security code. (Page 4)

REMOTE CONTROLLER

Overview

Optional Remote Controller KNA-RCDV331 is designed for controlling this unit. Refer to the instruction manual that comes with the remote controller.

⚠ Caution:

- Put the Remote Controller in a place where it will not move during braking or other operations. A dangerous situation could result if the Remote Controller falls down and gets wedged under the pedals while driving.
- Do not leave the battery near fire or under direct sunlight. A fire, explosion or excessive heat generation may result.
- Do not recharge, short, break up or heat the battery, or place it in an open fire. Such actions may cause the battery to leak fluid. If spilled fluid comes in contact with your eyes or clothing, immediately rinse with water and consult a physician.
- Place the battery out of reach of children. In the unlikely event that a child swallows the battery, immediately consult a physician.

❑ Battery installation

Use two "AAA"/"R03"-size batteries. Insert the batteries with the + and - poles aligned properly, following the illustration inside the case.

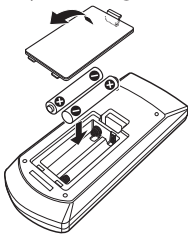

- If the Remote Controller operates only over shorter distances or does not operate at all, it is possible that the batteries are depleted. In such instances, replace both batteries with new ones.

❑ Remote Controller mode switch

The functions operated from the remote controller differ depending on the position of the mode switch.



AUD mode: Switch to this mode when controlling a selected source or radio source, etc.

DVD mode: Switch to this mode when playing DVDs or CDs etc. with the player integrated in this unit.

TV mode/ NAV mode: Not used.

- The position of the remote control mode switch is indicated in the title of each mode, e.g., "AUD mode".
- When controlling a player that is not integrated in the unit, select "AUD" mode.

Operations from the remote controller

❑ Common operations (AUD mode)

SRC	<ul style="list-style-type: none">• Selects the source.• Hangs up the incoming/current call.
▲/▼ VOL	Adjusts the volume level.
ATT	Attenuates/restores the sound.
DISP/V.SEL	Does not function for this unit.
ENTER	Enters options.
☎	Answers incoming calls.
FNC/PBC/ MENU	Displays the control screen of current source. (USB, iPod, DISC)
MODE/ TOP MENU	Changes the aspect ratio. <ul style="list-style-type: none">• The aspect ratio changes each time you press this key.
OPEN	Adjusts the panel angle.* <ul style="list-style-type: none">• The panel angle changes each time you press this key.

* Available for DDX9716BTS/DDX9716BTSR only.

REMOTE CONTROLLER

DVD/VCD (DVD mode)

▲/▼/◀/▶	Moves the cursor when displaying a menu.
◀◀/▶▶	Selects a track.
▶/	Starts/pauses playback.
■	Stops and memorizes the point where the disc stops.
0 - 9	<ul style="list-style-type: none"> Specifies the number to search for in direct search. ① ②ABD : Fast forwards/backwards. <ul style="list-style-type: none"> – Fast forward/backward speed changes each time you press this key. ④EHS ⑤JRC : Slow forwards/backwards during pause.
MODE/TOP MENU	Shows the disc top menu.
FNC/PBC/MENU	Shows the disc menu.
SUBTITLE	Changes the subtitle language.
ZOOM	Changes the zoom ratio. <ul style="list-style-type: none"> The zoom ratio changes each time you press this key.
ANGLE	Changes the picture angle. <ul style="list-style-type: none"> The picture angle changes each time you press this key.
AUDIO	Changes the voice language. <ul style="list-style-type: none"> The voice language changes each time you press this key.
DIRECT	Enters direct search mode. (See the far right column.)
CLEAR	Deletes a character while in direct search mode.

Music Disc/Audio file/Video file (AUD mode)

AM -/FM +	Selects a folder.
◀◀/▶▶	Selects a track/file.
▶/	Starts/pauses playback.
0 - 9	Music Disc: Specifies the number to search for in direct search.
DIRECT	Music Disc: Enters direct search mode. (See the right column.)
<input type="checkbox"/> Radio (AUD mode)	
AM -/FM +	Selects the band.
◀◀/▶▶	Searches for stations.
▶/	Changes the seek mode (AUTO1, AUTO2, MANU).
0 - 9	Specifies the frequency of the station to receive to search for in direct search.
DIRECT	Enters direct search mode. (See the right column.)

Digital Radio (DAB) (AUD mode) (Only for DDX8016DABS)

◀◀/▶▶	Searches for services.
▶/	Changes the seek mode (AUTO1, AUTO2, MANU).
1 - 9	Specifies preset number.
<input type="checkbox"/> iPod (AUD mode)	
◀◀/▶▶	Selects music.
▶/	Starts/pauses playback.

USB (AUD mode)

AM -/FM +	Selects a folder.
◀◀/▶▶	Selects a file.
▶/	Starts/pauses playback.

Searching for an item (chapter/title/track) directly

- Press DIRECT to enter the search mode. Each time you press DIRECT, the item to search for changes.
- Press a number button to select a desired item.
- Press ENTER to confirm the selection.

Searching for a tuner frequency directly

- Press DIRECT to enter the search mode.
- Press number buttons to enter a frequency.
- Press ◀◀/▶▶ to confirm the entry.

REMOTE CONTROLLER

Using the steering remote controller (Only for DDX8016DABS)

You can assign functions to the keys of the remote controller on the steering wheel.

- This function is available only when your vehicle is equipped with the electrical steering remote controller.
- You can only register/change the functions while you are parked.
- If your steering remote controller is not compatible, learning may not be completed and an error message may appear.

❑ Registering/changing the functions

- 1 Display the source/option selection screen. On the Home screen or the source control screen:



- 2 Display the <SETUP> screen.



- 3 Display the <User Interface> screen.



- Scroll the page to show more items.

- 4 Display the <Steering Remote Controller Setting> screen.



- 5 When the unit is ready for learning, press and hold a steering remote controller button for about 2 seconds to register/change.

- Refer to the message displayed to confirm whether the unit is ready before proceeding.

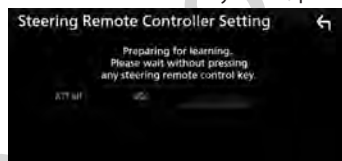

- 6 Select a function to assign.



- Scroll the page to show more items.
- To close the window, touch [Close].

- 7 Repeat steps 5 and 6 as necessary.
- 8 Finish the procedure.



- The unit can register/change all of the buttons' functions at the same time. To do this, press each button in turn and after pressing all of them, touch [Done] on the <Steering Remote Controller Setting> screen. However, new functions cannot be learned after this operation.
- When changing the functions already learned, touch the button you want to change in step 5 and then touch to select the new function from the function list.
- Confirm the contents of the settable functions in the function list. You cannot edit the function list.

❑ Initializing the settings

- 1 Display the <Steering Remote Controller Setting> screen. (See the far left column.)
- 2



A confirmation message appears. Touch [Yes].

CONNECTION/INSTALLATION

Before installing the unit

⚠ WARNING

- If you connect the ignition wire (red) and the battery wire (yellow) to the car chassis (ground), you may cause a short circuit, that in turn may start a fire. Always connect those wires to the power source running through the fuse box.
- Do not cut out the fuse from the ignition wire (red) and the battery wire (yellow). The power supply must be connected to the wires via the fuse.

⚠ Precautions on installation and connection

- Mounting and wiring this product requires skills and experience. For best safety, leave the mounting and wiring work to professionals.
- Make sure to ground the unit to a negative 12 V DC power supply.
- Do not install the unit in a location exposed to direct sunlight or excessive heat or humidity. Also avoid places with too much dust or the possibility of water splashing.
- Do not use your own screws. Use only the screws provided. If you use the wrong screws, you could damage the unit.
- If the power is not turned on ("There is an error in the speaker wiring. Please check the connections." is displayed), the speaker wire may have a short circuit or have touched the chassis of the vehicle and the protection function may have been activated. Therefore, the speaker wire should be checked.

- If your car's ignition does not have an ACC position, connect the ignition wires to a power source that can be turned on and off with the ignition key. If you connect the ignition wire to a power source with a constant voltage supply, such as with battery wires, the battery may be drained.
- Only for DDX9716BTS/DDX9716BTSR: If the console has a lid, make sure to install the unit so that the monitor panel will not hit the lid when closing and opening.
- If the fuse blows, first make sure the wires are not touching to cause a short circuit, then replace the old fuse with one with the same rating.
- Insulate unconnected wires with vinyl tape or other similar material. To prevent a short circuit, do not remove the caps on the ends of the unconnected wires or the terminals.
- Connect the speaker wires correctly to the terminals to which they correspond. The unit may be damaged or fail to work if you share the \ominus wires or ground them to any metal part in the car.
- When only two speakers are being connected to the system, connect both connectors either to the front output terminals or to the rear output terminals (do not mix front and rear). For example, if you connect the \oplus connector of the left speaker to a front output terminal, do not connect the \ominus connector to a rear output terminal.
- After the unit is installed, check whether the brake lamps, blinkers, wipers, etc. on the car are working properly.
- Mount the unit so that the mounting angle is 30° or less.
- Do not press hard on the panel surface when installing the unit in the vehicle. Otherwise scratches, damage, or failure may result.

- This unit has a cooling fan to decrease the internal temperature. Do not mount the unit in a place where the cooling fan of the unit is blocked. Blocking these openings will prevent the cooling of the internal temperature and result in malfunction.

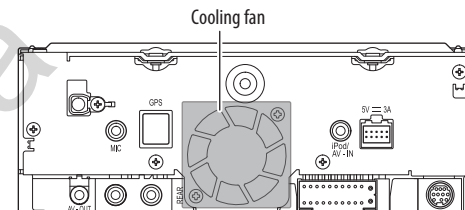

⚠ CAUTION

Install this unit in the console of your vehicle. Do not touch the metal parts of this unit during and shortly after the use of the unit. Metal parts such as the heat sink and enclosure become hot.

CONNECTION/INSTALLATION

❑ Supplied accessories for installation

- ① Wiring harness × 1
- ② Trim plate × 1
- ③ Extraction keys × 2
- ④ USB extension cable (1.0 m) × 1
- ⑤ GPS antenna (3.5 m) × 1
- ⑥ Metal plate × 1
- ⑦ Microphone (3 m) × 1

❑ Installation procedure

- 1 To prevent a short circuit, remove the key from the ignition and disconnect the ⊖ battery.
- 2 Make the proper input and output wire connections for each unit.
- 3 Connect the speaker wires of the wiring harness.
- 4 Take Connector B on the wiring harness and connect it to the speaker connector in your vehicle.
- 5 Take Connector A on the wiring harness and connect it to the external power connector in your vehicle.
- 6 Connect the wiring harness connector to the unit.
- 7 Install the unit in your car.
 - Make sure that the unit is installed securely in place. If the unit is unstable, it may malfunction (e.g., the sound may skip).
- 8 Reconnect the ⊖ battery.
- 9 Configure <Initial SETUP>. (Page 4)

Installing the unit

❑ Installing the unit

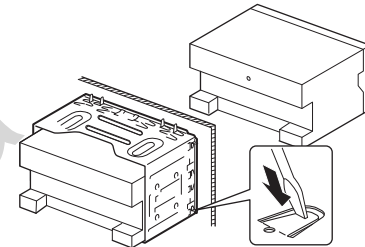

- Bend the tabs of the mounting sleeve with a screwdriver or similar utensil and attach it in place.

❑ Installing the trim plate

Attach the trim plate (②).

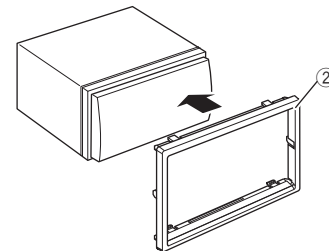

CONNECTION/INSTALLATION

Connection

Connecting wires to terminals

* Only for DDX8016DABS.

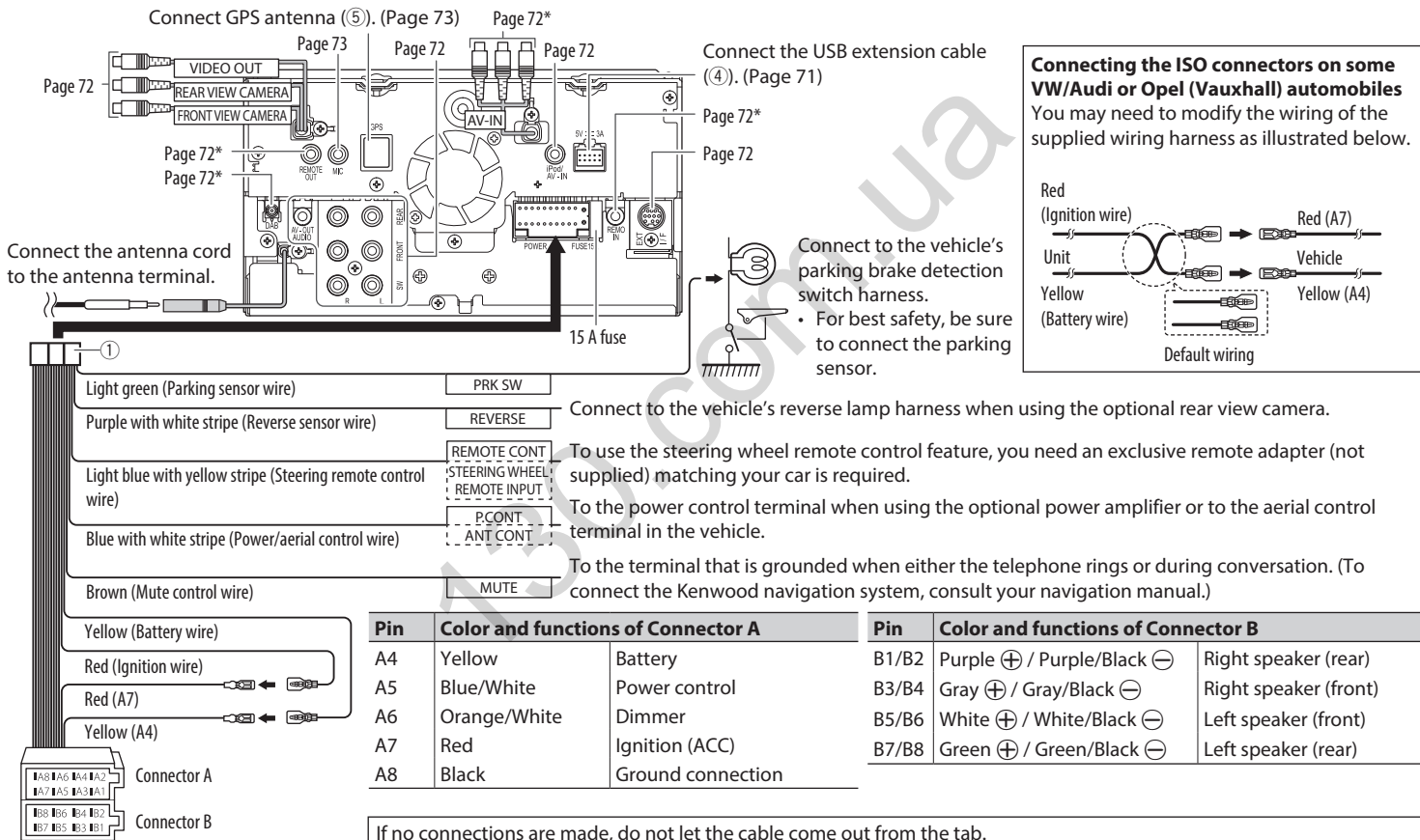

If no connections are made, do not let the cable come out from the tab.

CONNECTION/INSTALLATION

Connecting the USB extension cable

Connect the USB extension cable (4) to connect a USB device/iPod/iPhone/smartphone.

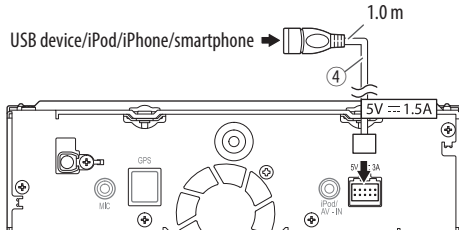

Connecting a USB device

- Connect the USB extension cable (4) beforehand. (See above.)

USB device* (commercially available)

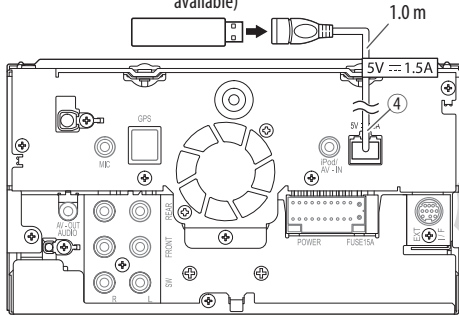

* Use CA-U1EX to extend the cable if necessary. (Max 500 mA, 5V)

Connecting an iPod/iPhone

- Connect the USB extension cable (4) beforehand. (See the left column.)

iPod/iPhone (30-pin connector models) (commercially available)

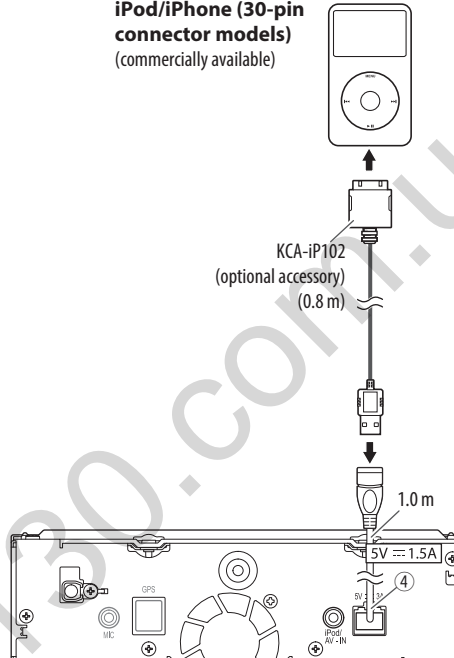

iPod/iPhone (Lightning connector models) (commercially available)

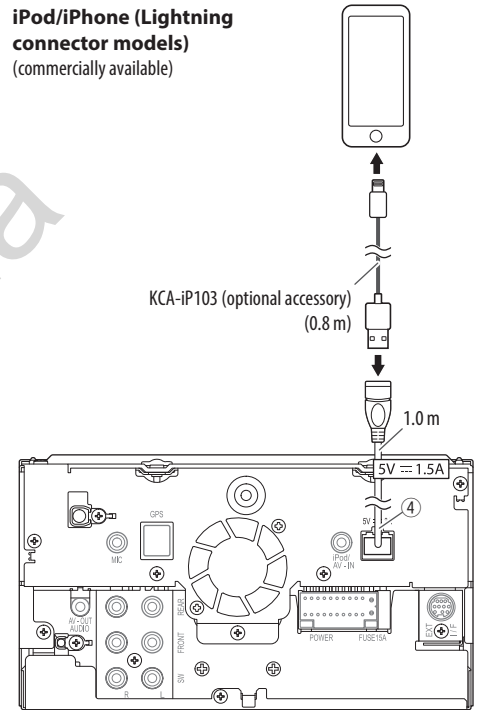

CONNECTION/INSTALLATION

❑ Connecting a smartphone/Android device

- Connect the USB extension cable (4) beforehand. (Page 71)

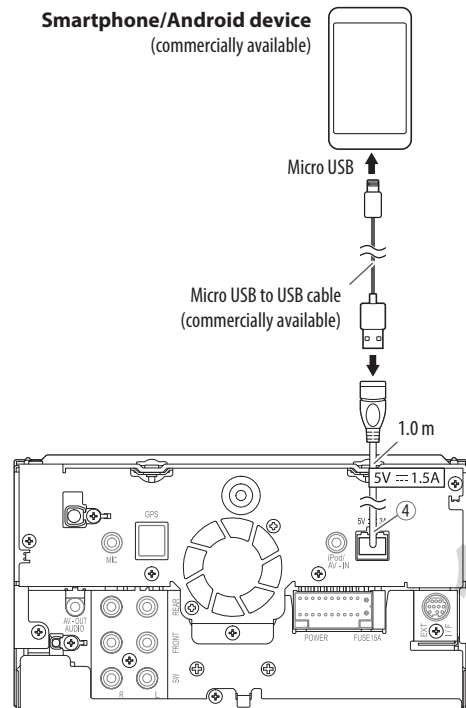

❑ Connecting external components

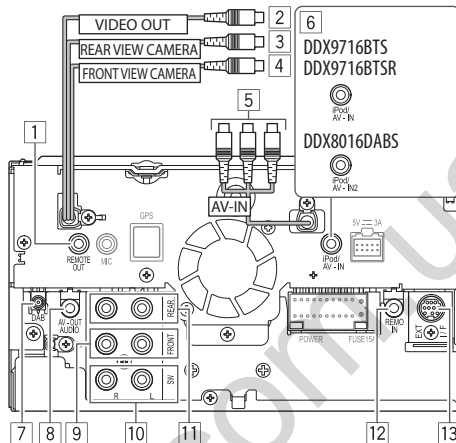

- TV tuner remote control output*1
- Video output (Yellow)
- Rear view camera input (Yellow)
- Front view camera input (Yellow)
- Audio Video input (AV-IN)*1
- Audio Video input
 - For DDX9716BTS/DDX9716BTSR: AV-IN
 - For DDX8016DABS: AV-IN2
- DAB aerial input*1
- AV-OUT/Audio output (ø3.5 mini jack)
Resistance-free stereo type mini plug
 - Audio left output (White)
 - Audio right output (Red)
- Front preout*2
 - Audio left output (White)
 - Audio right output (Red)
- Subwoofer preout (monaural output)*2
 - Subwoofer left output (White)
 - Subwoofer right output (Red)
- Rear preout*2
 - Audio left output (White)
 - Audio right output (Red)
- Direct steering remote control input (ø3.5 mini jack)*1
 - Contact your Kenwood dealer for details.
- External I/F for connecting a commercial adapter (DC 12 V 500 mA max)

*1 Only for DDX8016DABS.

*2 When connecting an external amplifier, connect its ground wire to the chassis of the car; otherwise the unit may be damaged.

CONNECTION/INSTALLATION

❑ Connecting microphone for Bluetooth

Connect the microphone (7) to the MIC terminal.

- To install the microphone, peel off the adhesive tape, fix it on the installation position, then adjust the direction of the microphone to face the driver. After installing, fix the microphone cable to the car with clamps (commercially available).
 - Clean the installation surface beforehand.

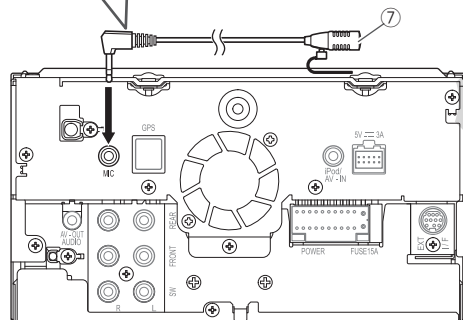
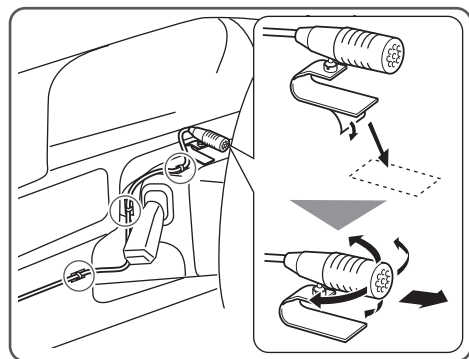

❑ Connecting the GPS antenna

Connect the GPS antenna (5) to the GPS terminal.

- To install the GPS antenna, fix the metal plate (6) firmly on the dashboard, then place the GPS antenna (5) on the metal plate (6).
 - Clean the dashboard or other surface beforehand.
 - Install the GPS antenna (5) inside of the car, as horizontally as possible to allow easy reception of the GPS satellite signals.
 - You can bend the metal plate (6) to conform to a curved surface, if necessary.

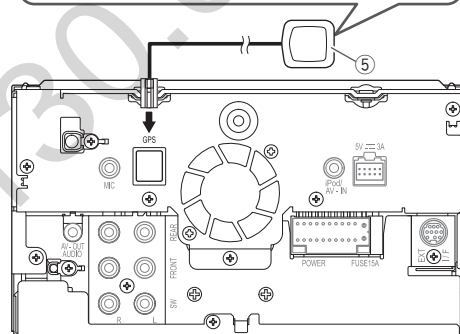
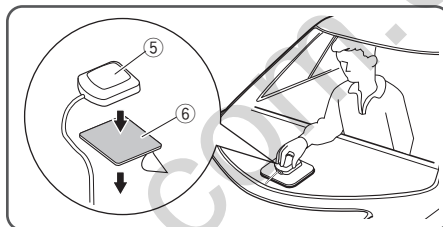

- Depending on the type of car, reception of the GPS satellite signals might not be possible with an internal installation.
- Install this GPS antenna in an area away from any antennas that are used with CB radios or satellite televisions.
- The GPS antenna should be installed at a position at least 30 cm from mobile phone or other transmitting antennas.
- The above types of communication may interfere with signals from the GPS satellite.
- Painting the GPS antenna with (metallic) paint may cause reduced performance.

CONNECTION/INSTALLATION

Removing the unit

□ Removing the trim plate

- 1 Engage the catch pins on the extraction key (3) and remove the two locks on the lower part. Lower the frame and pull it forward.

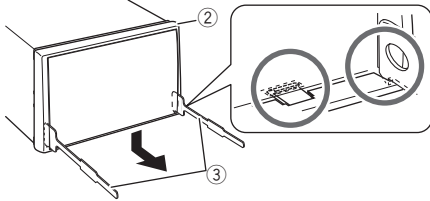

- 2 Remove from the upper two catches.

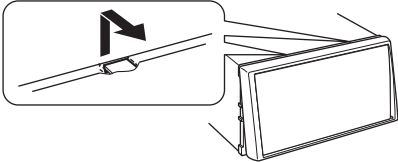

- The frame can be removed from the top side in the same manner.

□ Removing the unit

- 1 Remove the trim plate. (See the left column.)
- 2 Insert the two extraction keys (3), then pull them as illustrated so that the unit can be removed.

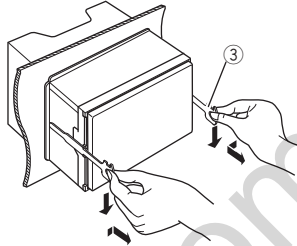

- Be careful to avoid injury from the catch pins on the extraction key.

REFERENCES

Maintenance

❑ Caution on cleaning the unit

Do not use any solvent (for example, thinner, benzine, etc.), detergent, or insecticide. This may damage the monitor or the unit.

Recommended cleaning method:

Gently wipe the panel with a soft, dry cloth.

❑ Moisture condensation

Moisture may condense on the lens inside the unit in the following cases:

- After starting the heater in the car.
- If it becomes very humid inside the car.

Should this occur, the unit may malfunction. In this case, eject the disc and leave the unit turned on for a few hours until the moisture evaporates.

❑ How to handle discs

- When removing a disc from its case, press down the center holder of the case and lift the disc out, holding it by the edges.



- Always hold the disc by the edges. Do not touch its recording surface.
- When storing a disc in its case, gently insert the disc around the center holder (with the printed surface facing up).
 - Make sure to store discs in their cases after use.

❑ To keep discs clean

Dirty discs may not play correctly.

If a disc does become dirty, wipe it with a soft cloth in a straight line from the center to the edge.



- Do not use any solvents (for example, conventional record cleaner, spray, thinner, benzine, etc.) to clean discs.

❑ To play new discs

New discs may have some rough spots around the inner and outer edges. If such a disc is used, this unit may reject the disc.



- To remove these rough spots, rub the edges with a pencil or ball-point pen, etc.

More information

❑ File playback

Playing MPEG1/MPEG2 files

- This unit can play back MPEG1/MPEG2 files with the extension code <.mpg> or <.mpeg>.
- The stream format should conform to MPEG system/program stream.
 - The file format should be MP@ML (Main Profile at Main Level)/SP@ML (Simple Profile at Main Level)/MP@LL (Main Profile at Low Level).
- Audio streams should conform to MPEG1 Audio Layer-2 or Dolby Digital.

Playing MPEG4/H.264/WMV/MKV files

- This unit can play back files with the extension code <.mp4>, <.m4v>, <.avi>, <.wmv> or <.mkv>.
- This unit can only play back files which are less than 2 GB.
- The stream format should conform to MPEG system/program stream.

REFERENCES

Playing MP3/WMA/WAV/AAC-LC/FLAC/Vorbis files

- This unit can play back files with the extension code <.mp3>, <.wma>, <.wav>, <.m4a>, <.flac> or <.ogg> (regardless of the letter case—upper/lower).
- This unit can play back files that meet the conditions below:
 - Bit rate:
 - MP3: 8 kbps – 320 kbps
 - WMA: 48 kbps – 192 kbps
 - AAC: For discs: 16 kbps – 320 kbps
 - For USB: 32 kbps – 320 kbps
 - Sampling frequency:
 - MP3: 8 kHz – 48 kHz
 - WMA: For discs: 32 kHz – 48 kHz
 - For USB: 8 kHz – 48 kHz
 - WAV: 32 kHz/44.1 kHz/48 kHz
 - AAC: 16 kHz – 48 kHz
 - FLAC/Vorbis: 8 kHz – 48 kHz

- This unit can show ID3 Tag Version 1.0/1.1/2.2/2.3/2.4 (for MP3).
- This unit can also show WMA/AAC/FLAC/Vorbis Comment Tag.
- This unit can play back files recorded in VBR (variable bit rate).
- Files recorded in VBR have a discrepancy in elapsed time indication.
- This unit cannot play back the following files:
 - MP3 files encoded with MP3i and MP3 PRO format.
 - MP3 files encoded with Layer 1/2.
 - WMA files encoded with lossless, professional, and voice format.
 - WMA files which are not based upon Windows Media® Audio.
 - WMA/AAC files copy-protected with DRM.
 - AAC files encoded using any other application than iTunes.
 - AAC files copy-protected with FairPlay (except those stored on an iPod).
 - Files which have data such as AIFF, ATRAC3, etc.
- This unit can display jacket pictures that meet the conditions below:
 - Picture size: 32 x 32 to 1 232 x 672 (PNG: 800 x 480) resolution
 - Data size: less than 650 KB
 - File type: JPEG

Disc playback Playable disc types

Disc type	Recording format, file type, etc.
DVD <ul style="list-style-type: none"> DTS sound cannot be reproduced or emitted from this unit. 	DVD Video* ¹
DVD Recordable/Rewritable (DVD-R/-RW*², +R/+RW*³) <ul style="list-style-type: none"> DVD Video: UDF bridge Audio/video files: ISO 9660 level 1, level 2, Romeo, Joliet 	<ul style="list-style-type: none"> DVD Video MPEG1/MPEG2/MPEG4/H.264/WMV/MKV MP3/WMA/AAC/FLAC/Vorbis
Dual Disc	DVD side
CD/VCD	<ul style="list-style-type: none"> VCD (Video CD) Audio CD
CD Recordable/Rewritable (CD-R/-RW) <ul style="list-style-type: none"> ISO 9660 level 1, level 2, Romeo, Joliet 	<ul style="list-style-type: none"> VCD (Video CD) CD-DA MP3/WMA/AAC/FLAC/Vorbis

*¹ DVD Region code:

For DDX9716BTS/DDX8016DABS: 2

For DDX9716BTSR: 5

If you insert a DVD Video disc of an incorrect Region Code, "Region Code Error" appears on the screen.

*² DVD-R recorded in multi-border format are also playable (except for dual layer discs). DVD-RW dual layer discs are not playable.

*³ It is possible to play back finalized +R/+RW (Video format only) discs. "DVD" is selected as the disc type when a +R/+RW disc is loaded. +RW double layer discs are not playable.

REFERENCES

Unplayable discs

- Unplayable disc types and formats are as follows:
 - DVD-Audio/DVD-ROM/DVD-VR discs
 - DivX/DVD+VR/DVD-RAM recorded on DVD-R/RW or +R/+RW
 - SVCD (Super Video CD), CD Text (CD-DA), CD-ROM, CD-I (CD-I Ready), DTS-CD
 - MPEG1/MPEG2/MPEG4/WMV/MKV recorded on CD-R/RW
- Discs that are not round.
- Discs with coloring on the recording surface or discs that are dirty.
- Recordable/Rewritable discs that have not been finalized.
- 8 cm discs. Attempting to insert these discs using an adapter may cause a malfunction.

DualDisc playback

The Non-DVD side of a “DualDisc” does not comply with the “Compact Disc Digital Audio” standard. Therefore, the use of the Non-DVD side of a DualDisc on this product cannot be recommended.

Playing Recordable/Rewritable discs

- This unit can recognize a total of 64 770 files and 254 folders (a maximum of 255 files per folder).
- Use only “finalized” discs.
- This unit can play back multi-session discs; however, unclosed sessions will be skipped while playing.
- Some discs or files may not be played back due to their characteristics or recording conditions.

❑ About data stored in the connected USB device/iPod/iPhone

- We bear no responsibility for any loss of data in iPod/iPhone and USB mass storage class devices while using this unit.

❑ USB playback

Playable files on a USB device

- This unit can play the following types of files stored in a USB mass storage class device.
 - MPEG1/MPEG2/MPEG4/MP3/WMA/WAV/AAC/FLAC/H.264/WMV/MKV
- This unit can recognize a maximum of 9 999 files and a maximum of 9 999 folders in a folder.
- Make sure all important data has been backed up to avoid losing the data.

Notes on using a USB device:

- This unit may not play back files in a USB device properly when using a USB extension cable.
- USB devices equipped with special functions such as data security functions cannot be used with the unit.
- Do not use a USB device with 2 or more partitions.
- Depending on the shape of the USB devices and connection ports, some USB devices may not be attached properly or the connection might be loose.
- This unit may not recognize a memory card inserted into a USB card reader.
- When connecting with a USB cable, use a USB 2.0 cable.
- The maximum number of characters (when the characters are 1 byte):
 - Folder names: 128 characters
 - File names: 128 characters
- Avoid using the USB device if it might affect driving safety.
- Do not pull out and connect the USB device repeatedly while “Reading” is shown on the screen.

- Electrostatic shock at connecting a USB device may cause abnormal playback of the device. In this case, disconnect the USB device then reset this unit and the USB device.
- Operation and power supply may not work as intended for some USB devices.
- Do not leave a USB device in the car, or expose to direct sunlight or high temperatures to prevent deformation or damage to the device.

❑ Notes on playing iPod/iPhone

- iPod/iPhone that can be connected to this unit:
 - Made for
 - iPod touch (6th Generation)
 - iPod touch (5th Generation)
 - iPhone 6s Plus
 - iPhone 6s
 - iPhone 6 Plus
 - iPhone 6
 - iPhone 5s
 - iPhone 5c
 - iPhone 5
 - iPhone 4s

REFERENCES

- For some iPod/iPhone models, the performance may be abnormal or unstable during operation. In this case, disconnect the iPod/iPhone device, then check its condition.
If the performance is not improved or slow, reset your iPod/iPhone.
- When you turn on this unit, the iPod/iPhone is charged through the unit.
- The text information may not be displayed correctly.

Language codes (for DVD language selection)

AA	Afar	GL	Galician	MI	Maori	SO	Somali
AB	Abkhazian	GN	Guarani	MK	Macedonian	SQ	Albanian
AF	Afrikaans	GU	Gujarati	ML	Malayalam	SR	Serbian
AM	Ameharic	HA	Hausa	MN	Mongolian	SS	Siswati
AR	Arabic	HI	Hindi	MO	Moldavian	ST	Sesotho
AS	Assamese	HR	Croatian	MR	Marathi	SU	Sundanese
AY	Aymara	HU	Hungarian	MS	Malay (MAY)	SW	Swahili
AZ	Azerbaijani	HY	Armenian	MT	Maltese	TA	Tamil
BA	Bashkir	IA	Interlingua	MY	Burmese	TE	Telugu
BE	Byelorussian	IE	Interlingue	NA	Nauru	TG	Tajik
BG	Bulgarian	IK	Inupiak	NE	Nepali	TH	Thai
BH	Bihari	IN	Indonesian	NO	Norwegian	TI	Tigrinya
BI	Bislama	IS	Icelandic	OC	Occitan	TK	Turkmen
BN	Bengali, Bangla	IW	Hebrew	OM	(Afan) Oromo	TL	Tagalog
BO	Tibetan	JA	Japanese	OR	Oriya	TN	Setswana
BR	Breton	JI	Yiddish	PA	Panjabi	TO	Tonga
CA	Catalan	JW	Javanese	PL	Polish	TR	Turkish
CO	Corsican	KA	Georgian	PS	Pashto, Pushto	TS	Tsonga
CS	Czech	KK	Kazakh	QU	Quechua	TT	Tatar
CY	Welsh	KL	Greenlandic	RM	Rhaeto-Romance	TW	Twi
DZ	Bhutani	KM	Cambodian	RN	Kirundi	UK	Ukrainian
EL	Greek	KN	Kannada	RO	Rumanian	UR	Urdu
EO	Esperanto	KO	Korean (KOR)	RW	Kinyarwanda	UZ	Uzbek
ET	Estonian	KS	Kashmiri	SA	Sanskrit	VI	Vietnamese
EU	Basque	KU	Kurdish	SD	Sindhi	VO	Volapuk
FA	Persian	KY	Kirghiz	SG	Sangho	WO	Wolof
FI	Finnish	LA	Latin	SH	Serbo-Croatian	XH	Xhosa
FJ	Fiji	LN	Lingala	SI	Singhalese	YO	Yoruba
FO	Faroese	LO	Laothian	SK	Slovak	ZU	Zulu
FY	Frisian	LT	Lithuanian	SL	Slovenian		
GA	Irish	LV	Latvian, Lettish	SM	Samoan		
GD	Scots Gaelic	MG	Malagasy	SN	Shona		

REFERENCES

Error message list

If an error occurs while using the unit, a message appears. Take appropriate action according to the following message/remedy/cause list.

“No Signal”/“No Video Signal”:

- Start playback on the external component connected to the AV-IN1 or iPod/AV-IN2 input terminal (DDX8016DABS) or AV-IN/iPod input terminal (DDX9716BTS/DDX9716BTSR).
- Check the cords and connections.
- Signal input is too weak.

“There is an error in the speaker wiring. Please check the connections.”:

- A speaker cord has shorted or it has come into contact with the car chassis. Wire or insulate the speaker cord as appropriate. (Page 70)

“Parking off”:

- No playback picture is shown when the parking brake is not engaged.

“Unsupported Device”:

- The USB power voltage is abnormal.
- Turn off and turn on the unit.
- Connect another USB device.

“Cannot play this file.”:

- Check whether the file is compatible with this unit. (Page 75)

“Connect failed.”:

- The device is paired but the connection has failed. Connect the paired device. (Page 42)

“Please Wait...”:

- The unit is preparing to use the Bluetooth function. If the message does not disappear, turn off and turn on the unit, then connect the device again.

“Voice Recognition is not available.”:

- The connected mobile phone does not have a voice recognition system.

“No Contents”:

- No phone book data is contained in the connected Bluetooth phone.

“Antenna Error”:

- The aerial has a short-circuit and the protective circuit has activated.
- Check the Digital Radio aerial. If a passive aerial without a booster is used, set aerial power to “OFF”.

Troubleshooting

What appears to be trouble is not always serious. Check the following points before calling a service center.

- For operations with the external components, refer also to the instructions supplied with the adapters used for the connections (as well as the instructions supplied with the external components).

□ General

No sound comes out of the speakers.

- Adjust the volume to the optimum level.
- Check the cords and connections.

No picture is displayed on the screen.

- Turn on the screen. (Page 8)

The remote controller* does not work.

- Replace the battery.

* Purchase KNA-RCDV331 separately.

REFERENCES

❑ Discs

Recordable/Rewritable discs cannot be played back.

- Insert a finalized disc.
- Finalize the discs with the component which you used for recording.

Tracks on the Recordable/Rewritable discs cannot be skipped.

- Insert a finalized disc.
- Finalize the discs with the component which you used for recording.

Playback does not start.

- The format of files is not supported by the unit.

No picture appears on the external monitor.

- Connect the video cord correctly.
- Select the correct input on the external monitor.
- Select the appropriate setting for **[AV-OUT]**. (Page 63)

MPEG1/MPEG2/MPEG4/WMV/H.264/MKV/MP3/WMA/AAC/WAV/FLAC/Vorbis discs cannot be played back.

- Record the tracks using a compatible application on the appropriate discs. (Page 76)
- Add appropriate extension codes to the file names.

Tracks on the Recordable/Rewritable discs are not played back as you have intended them to play.

- Playback order may differ from the one played back using other players.

❑ USB

“Reading” does not disappear from the screen.

- Turn the power off and on again.

While playing a track, sound is sometimes interrupted.

- The tracks are not properly copied into the USB device. Copy the tracks again, and try again.

Tracks are not played back as you have intended them to play.

- Playback order may differ from the one played back using other players.

❑ iPod/iPhone

No sound comes out of the speakers.

- Disconnect the iPod/iPhone, then connect it again.
- Select another source, then reselect **“iPod”**.

The iPod/iPhone does not turn on or does not work.

- Check the connecting cable and its connection.
- Update the firmware version.
- Charge the battery.
- Reset the iPod/iPhone.

Sound is distorted.

- Deactivate the equalizer either on this unit or the iPod/iPhone.

A lot of noise is generated.

- Turn off (uncheck) **“VoiceOver”** on the iPod/iPhone. For details, visit <http://www.apple.com>.

No operations are available when playing back a track containing artwork.

- Operate the unit after the artwork has loaded.

The iPod/iPhone not compatible with CarPlay cannot be connected via Bluetooth.

- Select **[ON]** for **[CarPlay Connection]** on the **<AV>** menu screen. (Page 25)

Videos cannot be played.

- Check the connection.
 - For iPod/iPhone 30-pin connector model: Connect with USB Audio and Video cable KCA-iP202 (optional accessory). Other cables cannot be used.

No sound of videos comes out.

- Check the connection.
 - For iPod/iPhone 30-pin connector model: Connect with USB Audio and Video cable KCA-iP202 (optional accessory). Other cables cannot be used.

❑ Radio

AME automatic presetting does not work.

- Store stations manually. (Page 28)

Static noise while listening to the radio.

- Connect the aerial firmly.

REFERENCES

❑ Digital Radio (DAB) (only for DDX8016DABS)

Cannot receive an ensemble.

- Your area is not covered by the ensemble.

The DAB aerial is not properly extended or positioned.

- Adjust the aerial and try the ensemble scanning again.
- Connect an active aerial (not supplied).

❑ AV-IN

No picture appears on the screen.

- Turn on the video component if it is not on.
- Connect the video component correctly.

❑ Android Auto*/Apple CarPlay

Desired source (“Android Auto”/“Apple CarPlay”) is not displayed on the Home screen.

- Check whether the connected device is compatible with CarPlay or Android Auto.
- When iPhone compatible with CarPlay is connected, check the [CarPlay Connection] setting. (Page 25)

Navigation does not work for “Apple CarPlay”/“Android Auto”.

- Connect the GPS antenna firmly. (Page 73)

* Android Auto is available only for DDX9716BTS/DDX9716BTSR.

❑ Bluetooth

Phone sound quality is poor.

- Reduce the distance between the unit and the Bluetooth mobile phone.
- Move the car to a place where you can get a better signal reception.

The sound is interrupted or skipped while using a Bluetooth audio player.

- Reduce the distance between the unit and the Bluetooth audio player.
- Disconnect the device connected for Bluetooth phone.
- Turn off, then turn on the unit.
(When the sound is not yet restored) connect the player again.

The connected audio player cannot be controlled.

- Check whether the connected audio player supports AVRCP (Audio/Video Remote Control Profile).

The Bluetooth device does not detect the unit.

- Search from the Bluetooth device again.

The unit does not pair with the Bluetooth device.

- For devices compatible with Bluetooth 2.1:
Register the device using a PIN code. (Page 41)
- For devices compatible with Bluetooth 2.0:
Enter the same PIN code for both the unit and target device. If the PIN code of the device is not indicated in its instructions, try “0000” or “1234.”
- Turn off, then turn on the Bluetooth device.

Echo or noise occurs.

- Adjust the microphone unit position.
- Adjust the echo volume or noise reduction volume. (Page 44)

The unit does not respond when you try to copy the phone book to the unit.

- You may have tried to copy the same entries (as stored) to the unit.

REFERENCES

Specifications

□ Monitor section

Picture Size (W × H)

DDX9716BTS/DDX9716BTSR:

6.95 inches (diagonal) wide
156.6 mm × 81.6 mm

DDX8016DABS: 6.2 inches (diagonal) wide
137.5 mm × 77.2 mm

Display System Transparent TN LCD panel

Drive System TFT active matrix system

Number of Pixels 1 152 000 (800H × 480V × RGB)

Effective Pixels 99.99 %

Pixel Arrangement

RGB striped arrangement

Back Lighting LED

□ DVD player section

D/A Converter 24/32 bit

Audio Decoder Linear PCM/Dolby Digital/MP3/
WMA/AAC/WAV/FLAC/Vorbis

Video Decoder MPEG1/MPEG2/MPEG4/
WMV/H.264/MKV

Wow & Flutter Below Measurable Limit

Frequency Response

96 kHz Sampling: 20 Hz to 44 000 Hz

48 kHz Sampling: 20 Hz to 22 000 Hz

44.1 kHz Sampling: 20 Hz to 20 000 Hz

Total Harmonic Distortion

0.010 % (1 kHz)

Signal to Noise Ratio

98 dB (DVD-Video 96 kHz)

Dynamic Range 98 dB (DVD-Video 96 kHz)

Disc Format DVD-Video/VIDEO-CD/CD-DA

Sampling Frequency

44.1 kHz/48 kHz/96 kHz

Quantifying Bit Number

16/20/24 bit

□ USB interface section

USB Standard USB 2.0 High Speed

File System FAT 16/32, NTFS

Maximum Power Supply Current
DC 5 V \pm 1.5 A × 1

D/A Converter 24/32 bit

Audio Decoder MP3/WMA/AAC/WAV/FLAC/
Vorbis

Video Decoder MPEG1/MPEG2/MPEG4/
WMV/H.264/MKV

□ Bluetooth section

Technology Bluetooth 3.0

Frequency 2.402 GHz to 2.480 GHz

Output Power +4 dBm (MAX), 0 dBm (AVE),
Power Class 2

Maximum Communication Range

Line of sight approx. 10 m

Audio Codec SBC/AAC

Profile

HFP (V 1.6) (Hands Free Profile)
A2DP (Advanced Audio
Distribution Profile)

AVRCP (V1.5) (Audio/Video
Remote Control Profile)

GAP (Generic Access Profile)

PBAP (Phone Book Access Profile)

SPP (Serial Port Profile)

REFERENCES

DSP section

Graphics equalizer

BAND	13 Band
Frequency (Hz) (BAND1-13)	62.5/100/160/250/400/630/1k/ 1.6k/2.5k/4k/6.3k/10k/16k
Gain	-9/-8/-7/-6/-5/-4/-3/-2/ -1/0/1/2/3/4/5/6/7/8/9 dB

2 Way X'Over

HIGH PASS FILTER frequency (Hz)	Through/30/40/50/60/70/80/90/ 100/120/150/180/220/250
SLOPE	-6/-12/-18/-24 dB/Oct.
LOW PASS FILTER frequency (Hz)	30/40/50/60/70/80/90/100/120/ 150/180/220/250/Through
SLOPE	-6/-12/-18/-24 dB/Oct.

Position

Front/Rear/Subwoofer Delay	0 cm to 610 cm (1.0 cm Step)
Gain	-8 dB to 0 dB

Subwoofer Level -50 dB to +10 dB

FM radio section

Frequency Range (50 kHz)
87.5 MHz to 108.0 MHz

Usable Sensitivity (S/N: 26 dB)
9.3 dBf (0.8 μ V/75 Ω)

Quieting Sensitivity (S/N: 46 dB)
15.2 dBf (1.6 μ V/75 Ω)

Frequency Response (\pm 3.0 dB)
30 Hz to 15 kHz

Signal to Noise Ratio
75 dB (MONO)

Selectivity (\pm 400 kHz)
 \geq 80 dB

Stereo Separation 45 dB (1 kHz)

LW tuner section

Frequency Range (9 kHz)
153 kHz to 279 kHz

Usable Sensitivity 45 μ V

MW tuner section

Frequency Range (9 kHz)
531 kHz to 1 611 kHz

Usable Sensitivity 25 μ V

Digital tuner (DAB) section (Only for DDX8016DABS)

Frequency Range
L-BAND: 1 452.960 MHz to 1 490.624 MHz
BAND III: 174.928 MHz to 239.200 MHz

Sensitivity -100 dBm

Signal to Noise Ratio
90 dB

DAB Antenna Connector

Connector type: SMB
Output Voltage: 14.4 V (11 V to 16 V allowable)
Maximum Current: < 100 mA

REFERENCES

Video section

Color System of External Video Input
NTSC/PAL

External Video Input Level (mini jack)
1 V_{p-p}/75 Ω

External Audio Max Input Level (mini jack)
2 V/25 kΩ

Video Output Level (RCA jack)
1 V_{p-p}/75 Ω

Audio Output Level (mini jack)
1.2 V/10 kΩ

Audio section

Maximum Power Output
50 W × 4

Typical Power Output
Full Bandwidth Power
(at less than 1 %THD)
22 W × 4

Output Frequency Band
20 Hz – 88 000 Hz

Preout Level 4 V/10 kΩ

Preout Impedance
≤ 600 Ω

Speaker Impedance
4 Ω to 8 Ω

General

Operating Voltage
14.4 V (10.5 V to 16 V allowable)

Maximum Current Consumption
15 A

Installation Dimensions (W × H × D)
DDX9716BTS/DDX9716BTSR:
182 mm × 112 mm × 162 mm
DDX8016DABS: 182 mm × 112 mm × 153 mm

Operational Temperature Range
–10°C to +60°C

Weight
DDX9716BTS/DDX9716BTSR: 2.3 kg
DDX8016DABS: 2.1 kg

Design and specifications are subject to change without notice.

Trademarks and licenses

- Manufactured under license from Dolby Laboratories. Dolby and the double-D symbol are trademarks of Dolby Laboratories.
- “DVD Logo” is a trademark of DVD Format/Logo Licensing Corporation registered in the US, Japan and other countries.
- The “AAC” logo is a trademark of Dolby Laboratories.
- Microsoft and Windows Media are either registered trademarks or trademarks of Microsoft Corporation in the United States and/or other countries.
- “Made for iPod,” and “Made for iPhone” mean that an electronic accessory has been designed to connect specifically to iPod, or iPhone, respectively, and has been certified by the developer to meet Apple performance standards. Apple is not responsible for the operation of this device or its compliance with safety and regulatory standards. Please note that the use of this accessory with iPod, or iPhone may affect wireless performance. iPhone, iPod, iPod classic, iPod nano, and iPod touch are trademarks of Apple Inc., registered in the U.S. and other countries.
- Lightning is a trademark of Apple Inc.
- Apple, Siri, Apple CarPlay and Apple CarPlay logo are trademarks of Apple Inc., registered in the U.S. and other countries.
- Android, Android Auto, Google Play and other marks are trademarks of Google Inc.
- This item incorporates copy protection technology that is protected by U.S. patents and other intellectual property rights of Rovi Corporation. Reverse engineering and disassembly are prohibited.

REFERENCES

- BlackBerry®, RIM®, Research In Motion® and related trademarks, names and logos are the property of Research In Motion Limited and are registered and/or used in the U.S. and countries around the world. Used under license from Research In Motion Limited.
- The Bluetooth® word mark and logos are registered trademarks owned by Bluetooth SIG, Inc. and any use of such marks by JVC KENWOOD Corporation is under license. Other trademarks and trade names are those of their respective owners.
- THIS PRODUCT IS LICENSED UNDER THE MPEG-4 VISUAL PATENT PORTFOLIO LICENSE FOR THE PERSONAL AND NON-COMMERCIAL USE OF A CONSUMER FOR (i) ENCODING VIDEO IN COMPLIANCE WITH THE MPEG-4 VISUAL STANDARD ("MPEG-4 VIDEO") AND/OR (ii) DECODING MPEG-4 VIDEO THAT WAS ENCODED BY A CONSUMER ENGAGED IN A PERSONAL AND NON-COMMERCIAL ACTIVITY AND/OR WAS OBTAINED FROM A VIDEO PROVIDER LICENSED BY MPEG LA TO PROVIDE MPEG-4 VIDEO. NO LICENSE IS GRANTED OR SHALL BE IMPLIED FOR ANY OTHER USE. ADDITIONAL INFORMATION INCLUDING THAT RELATING TO PROMOTIONAL, INTERNAL AND COMMERCIAL USES AND LICENSING MAY BE OBTAINED FROM MPEG LA, LLC. SEE [HTTP://WWW.MPEGLA.COM](http://www.mpegla.com).
- THIS PRODUCT IS LICENSED UNDER THE AVC PATENT PORTFOLIO LICENSE FOR THE PERSONAL USE OF A CONSUMER OR OTHER USES IN WHICH IT DOES NOT RECEIVE REMUNERATION TO (i) ENCODE VIDEO IN COMPLIANCE WITH THE AVC STANDARD ("AVC VIDEO") AND/OR (ii) DECODE AVC VIDEO THAT WAS ENCODED BY A CONSUMER ENGAGED IN A PERSONAL ACTIVITY AND/OR WAS OBTAINED FROM A VIDEO PROVIDER LICENSED TO PROVIDE AVC VIDEO. NO LICENSE IS GRANTED OR SHALL BE IMPLIED FOR ANY OTHER USE. ADDITIONAL INFORMATION MAY BE OBTAINED FROM MPEG LA, L.L.C. SEE [HTTP://WWW.MPEGLA.COM](http://www.mpegla.com).
- THIS PRODUCT IS LICENSED UNDER THE VC-1 PATENT PORTFOLIO LICENSE FOR THE PERSONAL AND NONCOMMERCIAL USE OF A CONSUMER TO (i) ENCODE VIDEO IN COMPLIANCE WITH THE VC-1 STANDARD ("VC-1 VIDEO") AND/OR (ii) DECODE VC-1 VIDEO THAT WAS ENCODED BY A CONSUMER ENGAGED IN A PERSONAL AND NON-COMMERCIAL ACTIVITY AND/OR WAS OBTAINED FROM A VIDEO PROVIDER LICENSED TO PROVIDE VC-1 VIDEO. NO LICENSE IS GRANTED OR SHALL BE IMPLIED FOR ANY OTHER USE. ADDITIONAL INFORMATION MAY BE OBTAINED FROM MPEG LA, L.L.C. SEE [HTTP://WWW.MPEGLA.COM](http://www.mpegla.com).
- libFLAC
Copyright (C) 2000,2001,2002,2003,2004,2005, 2006,2007,2008,2009 Josh Coalson
Redistribution and use in source and binary forms, with or without modification, are permitted provided that the following conditions are met:
 - Redistributions of source code must retain the above copyright notice, this list of conditions and the following disclaimer.
 - Redistributions in binary form must reproduce the above copyright notice, this list of conditions and the following disclaimer in the documentation and/or other materials provided with the distribution.
 - Neither the name of the Xiph.org Foundation nor the names of its contributors may be used to endorse or promote products derived from this software without specific prior written permission.THIS SOFTWARE IS PROVIDED BY THE COPYRIGHT HOLDERS AND CONTRIBUTORS "AS IS" AND ANY EXPRESS OR IMPLIED WARRANTIES, INCLUDING, BUT NOT LIMITED TO, THE IMPLIED WARRANTIES OF MERCHANTABILITY AND FITNESS FOR A PARTICULAR PURPOSE ARE DISCLAIMED. IN NO EVENT SHALL THE FOUNDATION OR CONTRIBUTORS BE LIABLE FOR ANY DIRECT, INDIRECT, INCIDENTAL, SPECIAL, EXEMPLARY, OR CONSEQUENTIAL DAMAGES (INCLUDING, BUT NOT LIMITED TO, PROCUREMENT OF SUBSTITUTE GOODS OR SERVICES; LOSS OF USE, DATA, OR PROFITS; OR BUSINESS INTERRUPTION) HOWEVER CAUSED AND ON ANY THEORY OF LIABILITY, WHETHER IN CONTRACT, STRICT LIABILITY, OR TORT (INCLUDING NEGLIGENCE OR OTHERWISE) ARISING IN ANY WAY OUT OF THE USE OF THIS SOFTWARE, EVEN IF ADVISED OF THE POSSIBILITY OF SUCH DAMAGE.

REFERENCES

- libvorbis

Copyright (c) 2002-2008 Xiph.org Foundation
Redistribution and use in source and binary forms,
with or without modification, are permitted
provided that the following conditions are met:

- Redistributions of source code must retain the above copyright notice, this list of conditions and the following disclaimer.
- Redistributions in binary form must reproduce the above copyright notice, this list of conditions and the following disclaimer in the documentation and/or other materials provided with the distribution.
- Neither the name of the Xiph.org Foundation nor the names of its contributors may be used to endorse or promote products derived from this software without specific prior written permission.

THIS SOFTWARE IS PROVIDED BY THE COPYRIGHT HOLDERS AND CONTRIBUTORS "AS IS" AND ANY EXPRESS OR IMPLIED WARRANTIES, INCLUDING, BUT NOT LIMITED TO, THE IMPLIED WARRANTIES OF MERCHANTABILITY AND FITNESS FOR A PARTICULAR PURPOSE ARE DISCLAIMED. IN NO EVENT SHALL THE FOUNDATION OR CONTRIBUTORS BE LIABLE FOR ANY DIRECT, INDIRECT, INCIDENTAL, SPECIAL, EXEMPLARY, OR CONSEQUENTIAL DAMAGES (INCLUDING, BUT NOT LIMITED TO, PROCUREMENT OF SUBSTITUTE GOODS OR SERVICES; LOSS OF USE, DATA, OR PROFITS; OR BUSINESS INTERRUPTION) HOWEVER CAUSED AND ON ANY THEORY OF LIABILITY, WHETHER IN CONTRACT, STRICT LIABILITY, OR TORT (INCLUDING NEGLIGENCE OR OTHERWISE) ARISING IN ANY WAY OUT OF THE USE OF THIS SOFTWARE, EVEN IF ADVISED OF THE POSSIBILITY OF SUCH DAMAGE.

- libogg

Copyright (c) 2002, Xiph.org Foundation
Redistribution and use in source and binary forms,
with or without modification, are permitted
provided that the following conditions are met:

- Redistributions of source code must retain the above copyright notice, this list of conditions and the following disclaimer.
- Redistributions in binary form must reproduce the above copyright notice, this list of conditions and the following disclaimer in the documentation and/or other materials provided with the distribution.
- Neither the name of the Xiph.org Foundation nor the names of its contributors may be used to endorse or promote products derived from this software without specific prior written permission.

THIS SOFTWARE IS PROVIDED BY THE COPYRIGHT HOLDERS AND CONTRIBUTORS "AS IS" AND ANY EXPRESS OR IMPLIED WARRANTIES, INCLUDING, BUT NOT LIMITED TO, THE IMPLIED WARRANTIES OF MERCHANTABILITY AND FITNESS FOR A PARTICULAR PURPOSE ARE DISCLAIMED. IN NO EVENT SHALL THE FOUNDATION OR CONTRIBUTORS BE LIABLE FOR ANY DIRECT, INDIRECT, INCIDENTAL, SPECIAL, EXEMPLARY, OR CONSEQUENTIAL DAMAGES (INCLUDING, BUT NOT LIMITED TO, PROCUREMENT OF SUBSTITUTE GOODS OR SERVICES; LOSS OF USE, DATA, OR PROFITS; OR BUSINESS INTERRUPTION) HOWEVER CAUSED AND ON ANY THEORY OF LIABILITY, WHETHER IN CONTRACT, STRICT LIABILITY, OR TORT (INCLUDING NEGLIGENCE OR OTHERWISE) ARISING IN ANY WAY OUT OF THE USE OF THIS SOFTWARE, EVEN IF ADVISED OF THE POSSIBILITY OF SUCH DAMAGE.



**Declaration of Conformity with regard to the EMC Directive
Declaration of Conformity with regard to the R&TTE Directive 1999/5/EC
Declaration of Conformity with regard to the RoHS Directive 2011/65/EU**

Manufacturer:

JVC KENWOOD Corporation
3-12 Moriya-cho, Kanagawa-ku, Yokohama-shi, Kanagawa, 221-0022, Japan

EU Representative:

JVCKENWOOD NEDERLAND B.V.
Amsterdamseweg 37, 1422 AC UITHOORN, The Netherlands

English

Hereby, JVC KENWOOD declares that this unit "DDX9716BTS/DDX9716BTSR/DDX8016DABS" is in compliance with the essential requirements and other relevant provisions of Directive 1999/5/EC.

French

Par la présente JVC KENWOOD déclare que l'appareil "DDX9716BTS/DDX9716BTSR/DDX8016DABS" est conforme aux exigences essentielles et aux autres dispositions pertinentes de la directive 1999/5/EC. Par la présente, JVC KENWOOD déclare que ce "DDX9716BTS/DDX9716BTSR/DDX8016DABS" est conforme aux exigences essentielles et aux autres dispositions de la directive 1999/5/EC qui lui sont applicables.

Deutsch

Hiermit erklärt JVC KENWOOD, dass sich dieser "DDX9716BTS/DDX9716BTSR/DDX8016DABS" in Übereinstimmung mit den grundlegenden Anforderungen und den anderen relevanten Vorschriften der Richtlinie 1999/5/EC befindet. (BMW) Hiermit erklärt JVC KENWOOD die Übereinstimmung des Gerätes "DDX9716BTS/DDX9716BTSR/DDX8016DABS" mit den grundlegenden Anforderungen und den anderen relevanten Festlegungen der Richtlinie 1999/5/EC. (Wien)

Nederlands

Hierbij verklaart JVC KENWOOD dat het toestel "DDX9716BTS/DDX9716BTSR/DDX8016DABS" in overeenstemming is met de essentiële eisen en de andere relevante bepalingen van richtlijn 1999/5/EC. Bij deze verklaart JVC KENWOOD dat deze "DDX9716BTS/DDX9716BTSR/DDX8016DABS" voldoet aan de essentiële eisen en aan de overige relevante bepalingen van Richtlijn 1999/5/EC.

Italiano

Con la presente JVC KENWOOD dichiara che questo "DDX9716BTS/DDX9716BTSR/DDX8016DABS" è conforme ai requisiti essenziali e alle altre disposizioni pertinenti stabilite dalla direttiva 1999/5/EC.

Español

Por medio de la presente JVC KENWOOD declara que el "DDX9716BTS/DDX9716BTSR/DDX8016DABS" cumple con los requisitos esenciales y cualesquiera otras disposiciones aplicables o exigibles de la Directiva 1999/5/EC.

Português

JVC KENWOOD declara que este "DDX9716BTS/DDX9716BTSR/DDX8016DABS" está conforme com os requisitos essenciais e outras disposições da Directiva 1999/5/EC.

Polska

JVC KENWOOD niniejszym oświadcza, że "DDX9716BTS/DDX9716BTSR/DDX8016DABS" spełnia zasadnicze wymogi oraz inne istotne postanowienia dyrektywy 1999/5/EC.

Český

JVC KENWOOD tímto prohlašuje, že tento "DDX9716BTS/DDX9716BTSR/DDX8016DABS" je ve shodě se základními požadavky a dalšími příslušnými ustanoveními směrnice 1999/5/EC.

Magyar

Alulírott, JVC KENWOOD, kijelenti, hogy a jelen "DDX9716BTS/DDX9716BTSR/DDX8016DABS" megfelel az 1999/5/EC irányelvben meghatározott alapvető követelményeknek és egyéb vonatkozó előírásoknak.

Svenska

Härmed intygar JVC KENWOOD att denna "DDX9716BTS/DDX9716BTSR/DDX8016DABS" står i överensstämmelse med de väsentliga egenskapskrav och övriga relevanta bestämmelser som framgår av direktiv 1999/5/EC.

Suomi

JVC KENWOOD vakuuttaa täten että "DDX9716BTS/DDX9716BTSR/DDX8016DABS" tyypinen laite on direktiivin 1999/5/EC oleellisten vaatimusten ja sitä koskevien direktiivin muiden ehtojen mukainen.

Slovensko

S tem JVC KENWOOD izjavlja, da je ta "DDX9716BTS/DDX9716BTSR/DDX8016DABS" v skladu z osnovnimi zahtevami in ostalimi ustreznimi predpisi Direktive 1999/5/EC.

Slovensky

Spoločnosť JVC KENWOOD týmto vyhlasuje, že "DDX9716BTS/DDX9716BTSR/DDX8016DABS" spĺňa základné požiadavky a ďalšie príslušné ustanovenia Direktívy 1999/5/EC.

Dansk

Undertegnede JVC KENWOOD erklærer herved, at følgende udstyr "DDX9716BTS/DDX9716BTSR/DDX8016DABS" overholder de væsentlige krav og øvrige relevante krav i direktiv 1999/5/EC.

Ελληνικά

ΜΕ ΤΗΝ ΠΑΡΟΥΣΑ JVC KENWOOD ΔΗΛΩΝΕΙ ΟΤΙ "DDX9716BTS/DDX9716BTSR/DDX8016DABS" ΣΥΜΜΟΡΦΩΝΕΤΑΙ ΠΡΟΣ ΤΙΣ ΟΥΣΙΩΔΕΙΣ ΑΠΑΙΤΗΣΕΙΣ ΚΑΙ ΤΙΣ ΛΟΙΠΕΣ ΣΧΗΤΙΚΕΣ ΔΙΑΤΑΞΕΙΣ ΤΗΣ ΟΔΗΓΙΑΣ 1999/5/EC.

Eesti

Sellega kinnitab JVC KENWOOD, et see "DDX9716BTS/DDX9716BTSR/DDX8016DABS" vastab direktiivi 1999/5/EC põhilistele nõudmistele ja muudele asjakohastele määrustele.

Latviešu

Ar šo, JVC KENWOOD, apstiprina, ka "DDX9716BTS/DDX9716BTSR/DDX8016DABS" atbilst Direktīvas 1999/5/EC galvenajām prasībām un citiem tās nosacījumiem.

Lietuviškai

Šiuo, JVC KENWOOD, pareiškia, kad šis "DDX9716BTS/DDX9716BTSR/DDX8016DABS" atitinka pagrindinius Direktyvos 1999/5/EC reikalavimus ir kitas svarbias nuostatas.

Malti

Hawnhekk, JVC KENWOOD, jiddikjara li dan "DDX9716BTS/DDX9716BTSR/DDX8016DABS" jikkonforma mal-hittigijiet essenzjali u ma provvedimenti oħrajn relevanti li hemm fid-Direttiva 1999/5/EC.

Українська

Компанія JVC KENWOOD заявляє, що цей виріб "DDX9716BTS/DDX9716BTSR/DDX8016DABS" відповідає ключовим вимогам та іншим пов'язаним положенням Директиви 1999/5/EC.

Türkçe

Bu vesileyle JVC KENWOOD, "DDX9716BTS/DDX9716BTSR/DDX8016DABS" ünitesinin, 1999/5/EC Direktifinin başlıca gereksinimleri ve diğer ilgili hükümleri ile uyumlu olduğunu beyan eder.

Hrvatski

Ovime JVC KENWOOD izjavljuje da je ova jedinica "DDX9716BTS/DDX9716BTSR/DDX8016DABS" je u skladu s osnovnim zahtjevima i drugim relevantnim odredbama Direktive 1999/5/EC.

130.com.ua

KENWOOD

Autogoods "130"

Spotify

With Spotify, your music is everywhere. Working out, partying or relaxing, the right music is always at your fingertips. There are millions of songs on Spotify—from old favorites to the latest hits. Just choose the music you love, or let Spotify surprise you.

You can stream Spotify from connected iPod touch/iPhone or Android devices.

- Install the latest version of the Spotify application on your iPod touch/iPhone/Android and create an account.

Preparation

- 1 Connect the device.
 - **For Android:** Pair the Android device through Bluetooth.
 - **For iPod touch/iPhone:** Connect iPod touch/iPhone.
- 2 Select the device to use and connection method on the **<APP Connection select>** of the **<APP/iPod SETUP>** screen. (Page 51)
- 3 Select **"Spotify"** as the source. (Page 12)
The Spotify application is started.

Playback operations

You can operate Spotify using the remote controller. Only playing, pausing, and skipping are available.

Indications and buttons on the source control screen

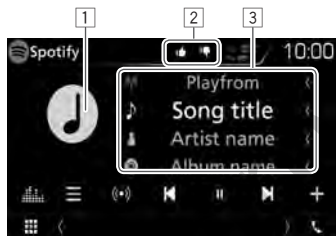

Playback information

- 1 Picture data
- 2 Thumbs up/ down or Playback mode (see below.)
- 3 Track information
 - Touching the text scrolls if not all of the text is shown.

Operation buttons

- [☰] Displays the list selection screen.
- [⦿] Creates new station.
- [◀] [▶] Selects a track.
- [▶]* Starts playback.
- [⏸]* Pauses playback.
- [+] Saves the current track/artist to **<Your Music>**.
- [👍] Thumbs down to the current track and skips to the next track.
- [👍] Registers the current track as a favorite.
- [🔄] Activates/deactivates the repeat playback mode.
- [🔀] Activates/deactivates the shuffle playback mode.
- [📊] Displays the **<Graphic Equalizer>** screen. (Page 54)

* During playback, [▢] is displayed, and when playback is paused, [▶] is displayed.

Spotify

❑ Creating your station (Start Radio)

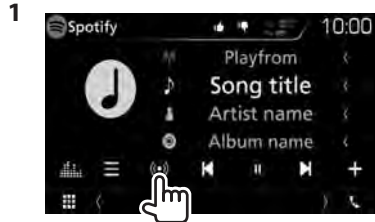

- 2 Enter a track/artist/playlist, then select the desired track.
The playback of your station starts with the selected track.

- You can personalize your station using thumb up ([👍]) or thumb down ([👎]).

❑ Selecting a track

- 1 Display the list selection screen.

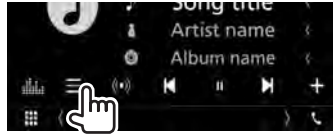

- 2 Select the list type (<Your Music>/<Browse>/<Radio>) (①), then select a desired item (②).

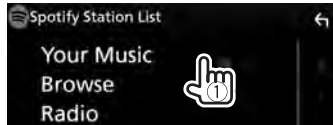

- Press [👍] to return to the top layer.
- Press [👎] to return to the upper layer.

Requirements for Spotify

iPhone or iPod touch

- Install the latest version of the Spotify application on your iPhone or iPod touch. (Search for “Spotify” in the Apple iTunes App Store to find and install the most recent version.)

- Connect iPod touch/iPhone to this unit with a cable or via Bluetooth.
 - When connecting with a cable: Use KCA-iP103 (optional accessory) or a KCA-iP102 (optional accessory).

Android™

- Visit Google Play™ and search for “Spotify” to install.
- Bluetooth must be built in and the following profiles must be supported.
 - SPP (Serial Port Profile)
 - A2DP (Advanced Audio Distribution Profile)

NOTE

- Ensure you are logged in to your smartphone application. If you do not have a Spotify account, you can create one for free from your smartphone or at www.spotify.com.
- Because Spotify is a third-party service, the specifications are subject to change without prior notice. Accordingly, compatibility may be impaired or some or all of the services may become unavailable.
- Some functions of Spotify cannot be operated from this unit.
- For issues using the application, contact Spotify at www.spotify.com.
- Establish an Internet connection using LTE, 3G, EDGE, or WiFi.
- Spotify and Spotify logos are trademarks of the Spotify Group.

