

KENWOOD

CMOS-320 CMOS-220

UNIVERSAL MULTI-VIEW CAMERA / UNIVERSAL REAR VIEW CAMERA

INSTRUCTION MANUAL

CAMÉRA MULTI-VUES UNIVERSELLE / CAMÉRA DE RECUL UNIVERSELLE

MODE D'EMPLOI

UNIVERSAL MULTIVIEW-KAMERA / UNIVERSAL RÜCKFAHRKAMERA

BEDIENUNGSANLEITUNG

UNIVERSELE MULTIVIEWCAMERA / UNIVERSELE ACHTERUITRIJCAMERA

GEBRUIKSAANWIJZING

JVCKENWOOD Corporation

Take the time to read through this instruction manual.

Familiarity with installation and operation procedures will help you obtain the best performance from your new Universal Camera.

For your records

Record the serial number, found on the back of the unit, in the spaces designated on the warranty card, and in the space provided below. Refer to the model and serial numbers whenever you call upon your Kenwood dealer for information or service on the product.

Model CMOS-320/CMOS-220 Serial number _____

US Residence Only

Register Online

Register your Kenwood product at www.Kenwoodusa.com

Before Use/ Installation Procedure

⚠️ WARNING

To prevent injury or fire, take the following precautions:

- To prevent a short circuit, never put or leave any metallic objects (such as coins or metal tools) inside the unit.
- Installation and wiring of this product require specialist skill and experience. To assure your safety, please request a specialist technician to install the unit.
- When you make a hole to install the camera, check the location of pipes, tanks and wiring and avoid touching them. Otherwise it may cause the fire.
- When you make a hole with a drill, use goggles to protect your eyes.

⚠️ CAUTION

To prevent damage to the product, take the following precautions:

- Make sure to ground the unit to a negative 12V DC power supply.
- When replacing a fuse, only use a new fuse with the prescribed rating. Using a fuse with the wrong rating may cause your unit to malfunction.
- Do not use your own screws. Use only the screws provided. If you use the wrong screws, you could damage the unit.

NOTE

- A rear view camera is a camera that provides symmetrical images in the same way as rear and side view mirrors.
- Connection to a TV with an RCA video input is possible, but confirm whether the TV you use has a reverse gear connection function.
- This product is designed to supplement the driver's rear view, but the camera images do not show all dangers and obstacles. Be sure to look behind you when reversing to confirm the view.
- This product features a wide-angle lens, so the near view is wide and the far view is narrow, which may create a false sense of distance. Be sure to look behind you when reversing to confirm the view.
- Do not wash your car with an automatic car wash or high-pressure water as it may result in water entering the camera or the camera falling off.
- Check camera bracket installation before driving.
Are the screws loose?
 - Is the camera bracket firmly secured?
 - If the rear view camera comes loose while you are driving it may cause an accident.

- Before finally installing the unit, connect the wiring temporarily, making sure it is all connected up properly, and the unit and the system work.
- When mounting this unit, make sure none of the leads are trapped between this unit and the surrounding metalwork or fittings.
- Do not mount this unit near the heater outlet, where it would be affected by heat, or near the doors, where rainwater might splash onto it. (Never install in locations such as the above because of the danger of malfunction due to high temperatures.)
- Before drilling any mounting holes always check behind where you want to drill the holes. Do not drill into the gas line, brake line, electrical wiring or other important parts.
- If this unit is installed in the passenger compartment, anchor it securely so it does not break free while the car is moving, and cause injury or an accident.
- If this unit is installed under a front seat, make sure it does not obstruct seat movement. Route all leads and cords carefully around the sliding mechanism so they do not get caught or pinched in the mechanism and cause a short circuit.

Care and maintenance

- When the product gets dirty, wipe dry with a silicon cloth or soft cloth. If it is seriously stained, remove stain with a cloth moistened with a neutral cleaner and then wipe the cleaner away. Do not use a hard cloth and/or a volatile substance such as lacquer thinner or alcohol, scratches, deformation, degradation and/or damage may result.
- When a lens component gets dirty, wipe gently with a soft cloth moistened with water. Do not rub with a dry cloth to prevent scratching the lens.

Installation Procedure

- 1** To prevent a short circuit, remove the key from the ignition and disconnect the \ominus battery.
- 2** Make the proper input and output wire connections for each unit.
- 3** Connect the wiring harness wires in the following order: ground, ignition and camera unit.
- 4** Install the unit in your car.
- 5** Reconnect the \ominus battery.

⚠ WARNING

- If you connect the ignition wire (Red) to the car chassis (Ground), you may cause a short circuit, that in turn may start a fire. Always connect those wires to the power source running through the fuse box.
- Do not cut out the fuse from the ignition wire (Red). The power supply must be connected to the wires via the fuse.

⚠ CAUTION

- If your car's ignition does not have an ACC position, connect the ignition wires to a power source that can be turned on and off with the ignition key. If you connect the ignition wire to a power source with a constant voltage supply, as with battery wires, the battery may die.
- If the fuse blows, first make sure the wires aren't touching to cause a short circuit, then replace the old fuse with one with the same rating.
- Insulate unconnected wires with vinyl tape or other similar material. To prevent a short circuit, do not remove the caps on the ends of the unconnected wires or the terminals.
- After the unit is installed, check whether the brake lamps, blinkers, wipers, etc. on the car are working properly.
- Install so that it does not obstruct the rear field of view.
- Install so that it does not protrude from the side of the car.
- Do not perform installation in rain or fog.
- When humidity is high, dry the surface to which the unit is to be attached before installing.
- Moisture on the attachment surface reduces adhesive strength, which may lead to the unit coming off.
- Do not attach the camera bracket to areas on the car body treated with fluorocarbon resin, or glass.
- May result in the rear view camera falling off.
- Do not apply water to the unit.
- Do not expose the unit to rain.
- Do not subject the camera to unnecessary force.
- Thoroughly clean where tape is used for sticking on the unit.
- Refer to the Instruction's manual for details on connecting the other units, then make connections correctly.
- Secure the wiring with cable clamps or adhesive tape. To protect the wiring, wrap adhesive tape around them where they lie against metal parts.
- Route and secure all wiring so it cannot touch any moving parts, such as the gear shift, handbrake and seat rails.
- Do not route wiring in places that get hot, such as near the heater outlet. If the insulation of the wiring melts or gets torn, there is a danger of the wiring short-circuiting to the vehicle body.
- When replacing the fuse, be sure to use only fuse of the rating prescribed on the fuse holder.
- To minimize noise locate the TV antenna cable, radio antenna cable and RCA cable as far away from each other as possible.

- Lay the cords by avoiding high-temperature areas. Use corrugated tubes for wiring inside the engine room. If a cord contacts a high-temperature area of the vehicle, the coating may melt and cause short-circuiting, which may lead to a fire or electric shock hazard.

Accessories

Camera (with camera bracket)1

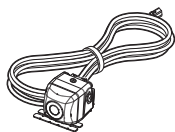

Power cord1

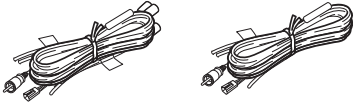

CMOS-320 CMOS-220

Grommet1
Camera bracket clamping screw.....1



CMOS-320 only

Switch unit.....1
Double-side adhesive tape1



Installation

⚠ CAUTION

• The adjustments during camera setting may be hindered depending on the camera installation position. Do not install the camera securely but attach it only temporarily until the camera setting has completed.

Recommended Installation Position

Examples of correct camera installation on the rear of the vehicle

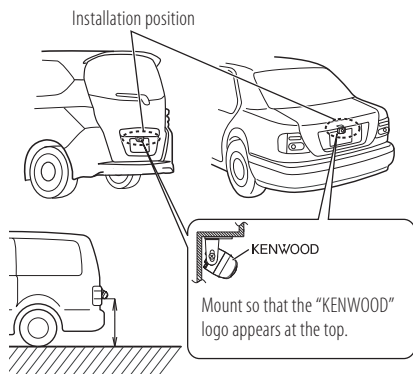

The CMOS-320 should be installed at a height of 50 cm (1.64 feet) or more.

Examples of correct camera installation on the front of the vehicle (CMOS-320 only)

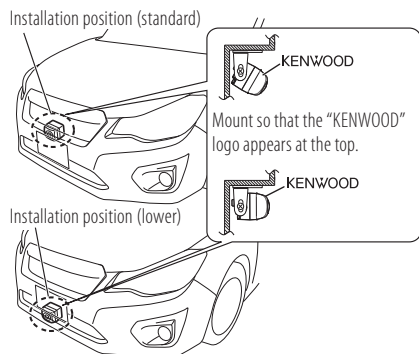

The CMOS-320 should be installed at a height of 30cm to 80cm (0.98feet to 2.62feet).

Installing the Camera/Adjusting its angle

1 Decide the camera installation position.

2 Clean the camera installation surface.

Using a commercially available cleaner, wipe dirt, moisture and oil away from the surface on which the camera bracket is to be attached.

3 Loosen the camera bracket retaining screws.

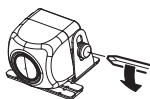

Using a commercially available Phillips screwdriver, loosen the two retaining screws.

Perform steps 4 and 5 only when they are required.

4 If required, separate the camera bracket from the camera and adjust the shape according to the surface on which it will be attached.

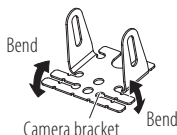

Adjust the camera bracket shape so that it fits the camera installation position.

5 Mount the camera on the camera bracket.

Mount so that the "KENWOOD" logo appears at the top.

6 Fix the camera temporarily with tape, etc.

Using a piece of tape, etc., fix the camera temporarily.

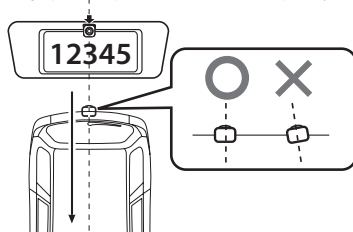

Install the camera at the center of the vehicle and not to hide the number plate. And also install straight toward the forward/reverse direction of the vehicle. Be careful not to lean the camera toward other directions of the vehicle, etc.

7 Complete all of the required connections.

8 Display the camera video.

Before viewing the camera, apply the parking brake and chock the wheels so that the vehicle will not move. Otherwise, an unexpected accident may result.

For displaying the camera video, read the instruction manual for your video monitor.

When the camera is installed as a rearview camera:

Change the shift lever to the R (Reverse) range to view the image of the rear of the vehicle.

When the camera is installed as a front camera (CMOS-320 only):

Refer to the instruction manual of the unit that you have connected this camera to, and display the image of the front of the vehicle.

9 Adjust the camera angle.

When adjusting the camera angle, be careful not to stretch the camera cord.

When installing CMOS-220 as a rearview camera:

Adjust the angle so that the rear of the vehicle or the bumper can be seen at the bottom of the monitor.

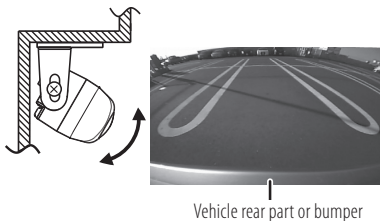

When installing CMOS-320 as a rearview camera:

Refer to "Display View Switching" (page 14) and switch the image to [Overhead View]. Adjust the camera angle so that the guideline and the parking lines become vertical.

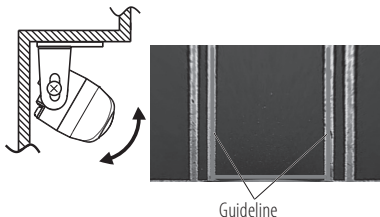

When installing CMOS-320 as a front camera:

Before adjusting the camera angle, perform "Camera ID Setting" (page 13) and "Camera Setting Procedure" (page 10).

When you select [Standard] for "Mounting Position Setting", switch the image to [Overhead View] (page 14) and adjust the camera angle so that the guideline and the parking lines become vertical.

When you select [Lower] for "Mounting Position Setting", switch the image to [Corner View] (page 14) and then adjust the angle of the camera to straighten the ground lines in the left and right screens.



10 Set the camera.

When using CMOS-320 as a rearview camera:

Refer to page 9 to 13 and perform "Preparation Before Camera Setting", "Overhead View Image Adjustment" and "Wide View Guideline Adjustment".

When using CMOS-320 as a front camera:

When you select [Standard] for "Mounting Position Setting", refer to page 9 to 13 and perform "Preparation Before Camera Setting", "Overhead View Image Adjustment" and "Wide View Guideline Adjustment".

When you select [Lower] for "Mounting Position Setting", refer to page 9 to 13 and perform "Preparation Before Camera Setting" and "Overhead View Image Adjustment". You cannot perform "Wide View Guideline Adjustment".

11 After adjusting the camera angle, tighten the retaining screws firmly.

Inspect the retaining screws at times. If they are loose, tighten them firmly.

Next page ►

Installation

12 Fix the camera firmly in position.

Peel off the paper liner from the double-side adhesive tape on the camera bracket and attach it. After attaching, push the camera bracket with your finger to ensure close adhesion. Do not touch the adhesive surface with your hand or peel and reattach an attached tape, as these will degrade the adhesive force and may cause the camera bracket to be detached. If required, secure the bracket on the vehicle body using the camera bracket clamping screw.

The camera bracket has two holes for the screw. Select one of them to fit the position of the attachment.

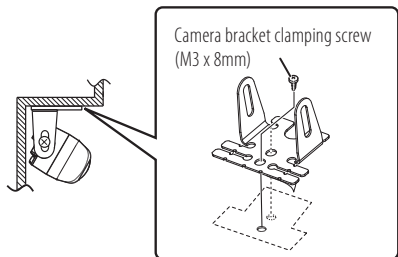

Installing the Switch Unit (CMOS-320 only)

1 Clean the switch unit installation surface.

Using a commercially available cleaner, wipe dirt, moisture and oil away from the surface on which the switch unit is to be attached.

2 Attach double-side adhesive tape on the bottom of the switch unit and then attach it in an easy-to-operate position, for example near the dashboard on the driver seat side.

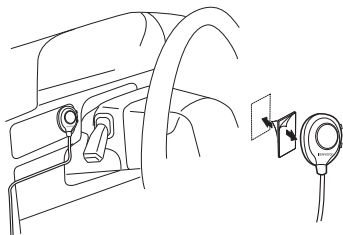

When using the camera as a front camera and with a Kenwood navigation system, this switch unit is used only for the ID setting of the CMOS-320 unit. So you do not have to attach the switch unit with double-side adhesive tape. For the ID setting, see "Camera ID Setting"(page 13)

Connections

Basic Connections

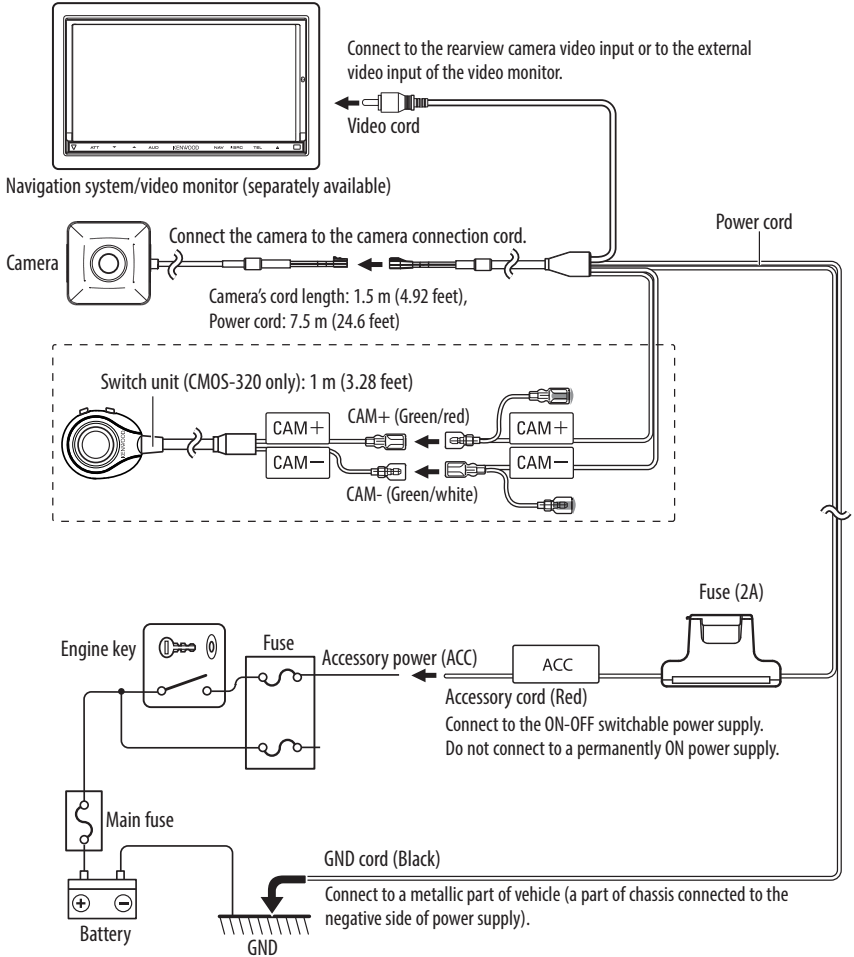

⚠ CAUTION

- If the engine key of your vehicle does not have the ACC position, branch the wire energized when the engine key is ON and connect it to the accessory power cord.
- Before proceeding to connections, make sure that the engine key is not inserted and disconnect the (-) terminal of the battery to prevent the short-circuiting incident.

System Connection (CMOS-320 only)

- When connecting the camera to a Kenwood navigation system etc, (Control unit) equipped with the camera control function, use the provided control unit connection cord. This allows the control unit to switch the display view and adjust the camera as well on touch the control unit screen.
- When using two CMOS-320 units (for the front and rear), it is required to set an ID for the front camera. For details, see “Camera ID Setting” (page 13).
- Connect the power supply in the same way as “Basic Connections”.
- The provided switch unit is not used in the system connection.

Connection of 2 Cameras

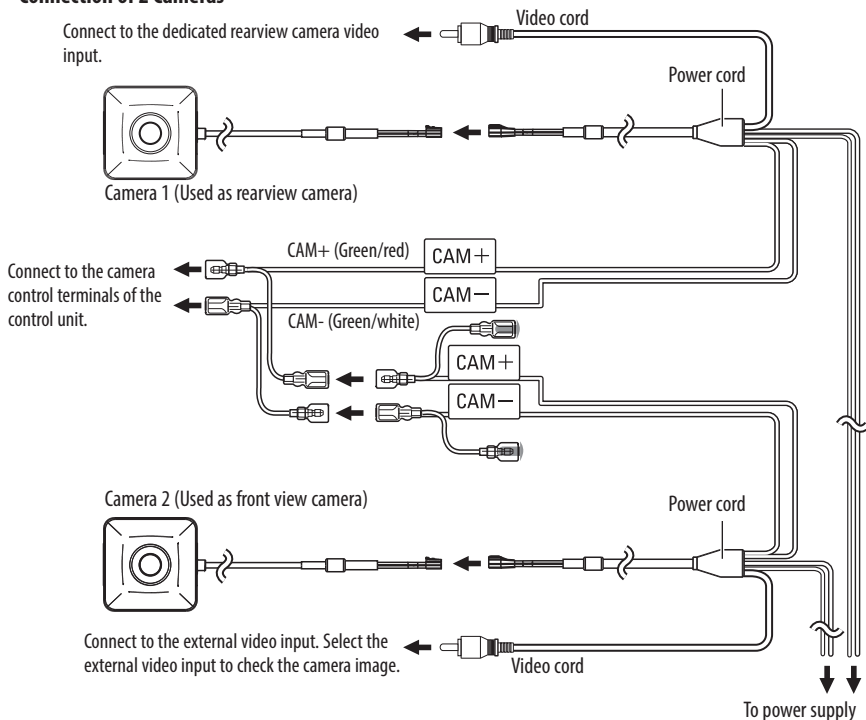

Camera Setting (CMOS-320 only)

Switch Unit Operation

The switch unit can be used to switch the image display mode, view/hide the guideline display and adjust the camera.

View button

- Switches the image display mode.
- Select an item in the setting mode.
- Press and hold to display or hide the guidelines.

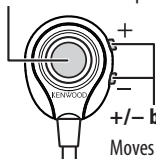

Moves across the setting mode items or sets an adjustment value.

Preparation Before Camera Setting

When the camera is installed as a rearview camera:

1 Stop the vehicle.

In a parking space with white lines and tire stoppers, park the vehicle in the center of the white line frame.

2 Advance the vehicle.

- Move the vehicle forward until the entire parking space can be viewed in the camera image.
- Be sure to apply the parking brake and push the brake pedal so that the vehicle is completely stationary. Perform the setting in a place that will not cause nuisance to other people.

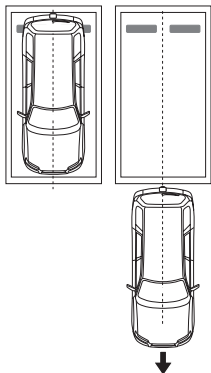

When installing the front camera at a height of 50cm (1.64 feet) or more:

Prepare as same as the rearview camera.

When installing the front camera below 50cm in height:

1 Install the camera at the center of the vehicle (page 4).

- If not, the image may not be symmetric in the "Corner View".

2 Move the vehicle on the center of the parking line.

- You can use a long stick instead of the parking line if you can not use the 2 parking lots etc.
- Be sure to apply the parking brake and push the brake pedal so that the vehicle is completely stationary. Perform the setting in a place that will not cause nuisance to other people.

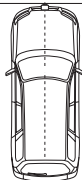
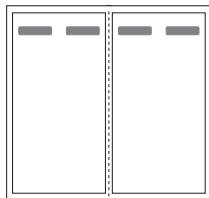

3 Set the camera.

Adjust the "Overhead View Image Adjustment" (page 10, 11) so that the parking line is displayed vertically in the center.

Camera Setting (CMOS-320 only)

Camera Setting Procedure

- 1 Complete all of the required connections in advance.
- 2 Display the camera video.
For displaying the camera video, read the instruction manual for your video monitor.
- 3 Press and hold the view and + buttons of the switch unit simultaneously to enter the camera adjustment mode.
- 4 First select the positioning of the camera.

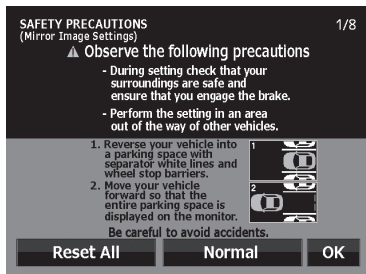

Use the + or – button to select an item and press the view button to enter the selection.

- When using the camera as the rearview camera, select [OK]. And then go to step 6.
 - When using the camera as the front camera, select [Normal] and then select [OK]. And then go to step 5.
 - Selecting [Reset All] resets all of the camera settings to the defaults.
- 5 Adjust the camera's mounting position with the + or – buttons on the switch unit.

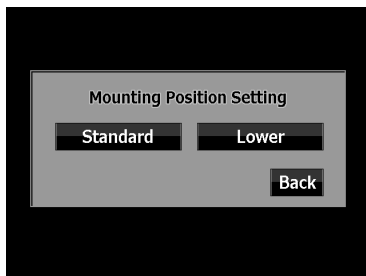

Select [Standard] when installing the camera at a height of 50cm to 80cm (1.64feet to 2.62feet).

- 6 Select a camera adjustment item and adjust it.
The following items are available for camera adjustment.
 1. Overhead view image adjustments
(Centering, Right-and-Left angle, Up-and-Down Angle)
 2. Wide view guideline adjustments
(Size, Horizontal direction, Red Line Position Setting)**To select an item:**
Press the + or – button to select an item and press the view button to enter the selection. When an adjustment item is selected, the frame of its icon turns from blue to yellow.
To adjust the item:
After selecting the item, press the + or – button to adjust it and press the view button to enter the adjusted value.
- 7 End the setting.

Overhead View Image Adjustment (Centering)

This item adjusts the center of the camera installation position.

- 1 Select "OVERHEAD VIEW IMAGE ADJUSTMENT (CENTERING)".
- 2 Press the + or – button of the switch unit so that the two white lines appear on the position corresponding to the center line of the vehicle.

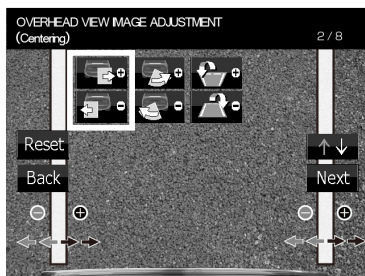

Adjustment is possible by two steps to the left and right. If the adjustment is not possible in the currently available range, change the camera position before retry.

- Select [Back] to go back to the previous adjustment item.
- Select [Next] to advance to the next adjustment item.
- Selecting [Reset] in an individual adjustment item resets the camera setting of that item to the default.

- Select [↕] to invert the icon upside down.

3 After completing the adjustment, press the view button.

↓ Advances to “OVERHEAD VIEW IMAGE ADJUSTMENT (Right-and-Left ANGLE)”.

Overhead View Image Adjustment (Right-and-Left Angle)

This item adjusts the horizontal angle (in the rotary direction) of the camera installation position.

1 Select “OVERHEAD VIEW IMAGE ADJUSTMENT (Right-and-Left ANGLE)”.

2 Press the + or – button of the switch unit so that the center of the parking space is displayed vertically.

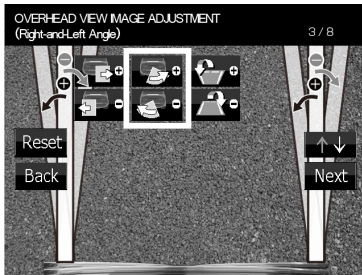

Adjustment is possible by one step to the left and right. If the adjustment is not possible in the currently available range, change the camera position before retrying.

3 After completing the adjustment, press the view button.

↓ Advances to “OVERHEAD VIEW IMAGE ADJUSTMENT (Up-and-Down ANGLE)”.

Overhead View Image Adjustment (Up-and-Down Angle)

This item adjusts the vertical angle (inclination) of the camera installation position.

1 Select “OVERHEAD VIEW IMAGE ADJUSTMENT (Up-and-Down ANGLE)”.

2 Press the + or – button of the switch unit so that the lines indicating the vehicle width are shown vertical.

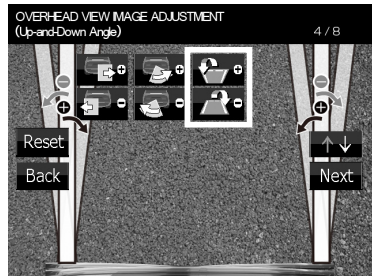

Adjustment is possible by one step up and down. If the adjustment is not possible in the currently available range, change the camera position before retrying.

3 After completing the adjustment, press the view button.

4 Select [Next].

↓ Advances to “GUIDELINE ADJUSTMENT (Size)”.

Camera Setting (CMOS-320 only)

For Guideline Adjustment

- The subsequent adjustments adjust the sizes, lengths and positions of the guidelines displayed in the wide view and overhead view. By default, guidelines shown below are displayed assuming that the camera installation height is 80 cm (2.62 feet) and that the distance between the left and right lines of the parking space is 2.2 meters (7.22 feet).
- The red line is used to indicate the parking position and can set it independently from other guide lines.

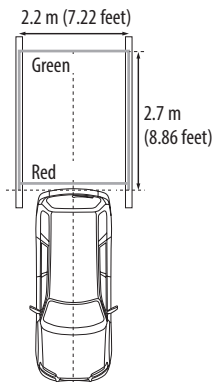

Wide View Guideline Adjustment (Size)

This item adjusts the overall size of guidelines displayed in the wide view.

- 1 Select "GUIDELINE ADJUSTMENT (Size)".
- 2 Press the + or – button of the switch unit to adjust the size.

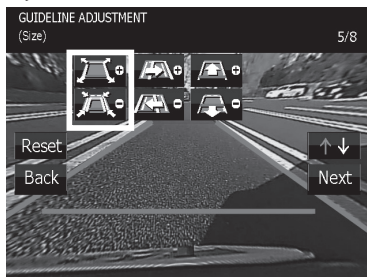

- 3 After completing the adjustment, press the view button.

↓ Advances to "GUIDELINE ADJUSTMENT (Horizontal direction)".

Wide View Guideline Adjustment (Horizontal Direction)

This item adjusts the left-right positioning of the guidelines displayed in the wide view.

- 1 Select "GUIDELINE ADJUSTMENT (Horizontal direction)".
- 2 Press the + or – button of the switch unit to adjust the left-right positioning.

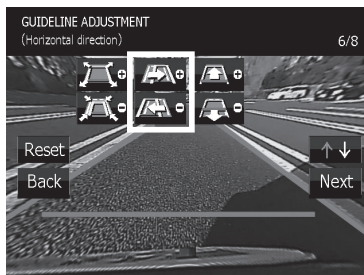

- 3 After completing the adjustment, press the view button.

↓ Advances to "GUIDELINE ADJUSTMENT (Red Line Position Setting)".

Wide View Guideline Adjustment (Red Line Position Setting)

This item adjusts the position of the red line displayed in the wide view. The red line can be used independently to set the reference line for the vehicle parking position.

- 1 Select "GUIDELINE ADJUSTMENT (Red Line Position Setting)".
- 2 Press the + or – button of the switch unit to adjust the position of the red line.

Move the red line until the edge of your vehicle's bumper. If the edge of your vehicle's bumper cannot be seen in the monitor, move the red line around the edge of your vehicle.

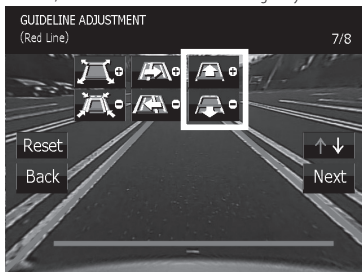

- 3 After completing the adjustment, press the view button.
- 4 Select [Next].

↓ Advances to "SETTING COMPLETE".

Finishing the Camera Setting

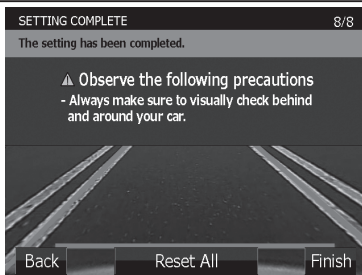

- 1 Press the + or – button of the switch unit to select [Finish] and press the view button.

Camera ID Setting

When connecting a CMOS-320 as a front camera to a Kenwood navigation system equipped with the camera control function, it is required to assign the ID to [Front Camera].

- 1 Install the switch unit.
Refer to "Basic Connections" (page 7) for the connection.
- 2 Display the image of the front camera on the monitor of the Kenwood navigation system.
For displaying the image, refer to the instruction manual of it.
- 3 Press and hold the + button of the switch unit for more than 2 seconds, and then press and hold the – button for more than 2 seconds.
- 4 Press the + or – button of the switch unit to select the camera ID, and press the view button.

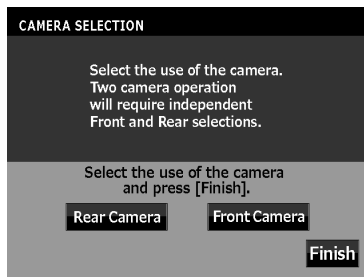

- 5 After setting, press the + or – button of the switch unit to select [Finish] and press the view button.
- 6 Turn off the ACC.
- 7 Disconnect the switch unit.
- 8 Connect CAM+/CAM– to the Kenwood car navigation system.
- 9 Turn on the ACC.

Display View Switching (CMOS-320 only)

Display View Switching

The CMOS-320 camera system can display 4 kinds of camera images.

- 1 With an image displayed on the monitor, press the view button of the switch unit.

Each press switches the image display mode in the following order.

Ultra Wide View

Wide-angle image covering a horizontal angle of about 195°.



Wide View

Camera image covering a horizontal angle of about 135°.



Overhead View

Image seen from the viewpoint straight up above the vehicle.

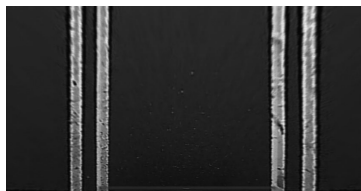

Depending on the camera installation position, the Overhead View image may not be displayed correctly.

- Overhead View may appear twice, depending on the connected navigation system.

Corner View

The views seen from the two corners of vehicle are displayed on the left and right halves of the screen.



When connecting the camera to a Kenwood navigation system etc, (Control unit) equipped with the camera control function, use the provided control unit connection cord. This allows the control unit to switch the display view as well on touch the control unit screen (page 8).

Specifications

Camnit (CMOS-320)

Output video

: Wide-angle mirror image (for rearview)/wide-angle normal image (for front view)

Sensor: 1/3.6-inch color CMOS sensor

Number of pixels: Approx. 330,000 pixels

Lens

: Wide angle, Focal length $f=1.05$ mm, F value 2.0

Angles of view

: Horizontal: Approx. 195°

: Vertical: Approx. 145°

Video output: 1.0 Vp-p/ 75Ω

Illumination range: Approx. 0.9 to 100,000 lux

Iris system: Electronic iris

Scanning system: Interlace

Synchronizing system: Internal synchronization

Dimensions (WxHxD): 23.4 x 23.4 x 26.1 mm

Weight: Approx. 23 g (without cable)

Camera Unit (CMOS-220)

Output video

: Wide-angle mirror image (for rearview)

Sensor: 1/3.6-inch color CMOS sensor

Number of pixels: Approx. 330,000 pixels

Lens

: Wide angle, Focal length $f=1.12$ mm, F value 2.2

Angles of view

: Horizontal: Approx. 128°

: Vertical: Approx. 103°

Video output: 1.0 Vp-p/ 75Ω

Illumination range: Approx. 0.9 to 100,000 lux

Iris system: Electronic iris

Scanning system: Interlace

Synchronizing system: Internal synchronization

Dimensions (WxHxD): 23.4 x 23.4 x 23.9 mm

Weight: Approx. 22 g (without cable)

Switch Unit (CMOS-320 only)

Dimensions (WxHxD): 27.5 x 32.8 x 12 mm

Weight: Approx. 10 g (without cable)

General

Operating voltage: 14.4V (9.0V – 16.0V)

Max. current consumption (CMOS-320): 100 mA

Max. current consumption (CMOS-220): 50 mA

- Mirror image means that the video image inverts the left and right just like the image seen on the rearview mirror or a side mirror.
- Specifications subject to change without notice.

Information on Disposal of Old Electrical and Electronic Equipment and Batteries (applicable for countries that have adopted separate waste collection systems)



Products and batteries with the symbol (crossed-out wheeled bin) cannot be disposed as household waste.



Old electrical and electronic equipment and batteries should be recycled at a facility capable of handling these items and their waste byproducts.



Pb

Contact your local authority for details in locating a recycle facility nearest to you. Proper recycling and waste disposal will help conserve resources whilst preventing detrimental effects on our health and the environment.

Notice: The sign "Pb" below the symbol for batteries indicates that this battery contains lead.