



PHONES

0 (800) 800 130  
(050) 462 0 130  
(063) 462 0 130  
(067) 462 0 130

130  
COM.UA

Internet store of  
autogoods



SKYPE

km-130

CAR RECEIVERS — Receivers • Media receivers and stations • Native receivers • CD/DVD changers • FM-modulators/USB adapters • Flash memory • Facia plates and adapters • Antennas • Accessories |  
 CAR AUDIO — Car audio speakers • Amplifiers • Subwoofers • Processors • Crossovers • Headphones • Accessories | TRIP COMPUTERS — Universal computers • Model computers • Accessories |  
 GPS NAVIGATORS — Portable GPS • Built-in GPS • GPS modules • GPS trackers • Antennas for GPS navigators • Accessories | VIDEO — DVR • TV sets and monitors • Car TV tuners • Cameras • Videomodules  
 • Transcoders • Car TV antennas • Accessories | SECURITY SYSTEMS — Car alarms • Bike alarms • Mechanical blockers • Immobilizers • Sensors • Accessories | OPTIC AND LIGHT — Xenon • Bixenon • Lamps  
 • LED • Stroboscopes • Optic and Headlights • Washers • Light, rain sensors • Accessories | PARKTRONICS AND MIRRORS — Rear parktronic • Front parktronic • Combined parktronic • Rear-view mirrors  
 • Accessories | HEATING AND COOLING — Seat heaters • Mirrors heaters • Screen-wipers heaters • Engine heaters • Auto-refrigerators • Air conditioning units • Accessories | TUNING — Vibro-isolation  
 • Noise-isolation • Tint films • Accessories | ACCESSORIES — Radar-detectors • Handsfree, Bluetooth • Windowlifters • Compressors • Beeps, loudspeakers • Measuring instruments • Cleaners • Car seats  
 • Miscellaneous | MOUNTING — Installation kits • Upholstery • Grilles • Tubes • Cable and wire • Tools • Miscellaneous | POWER — Batteries • Converters • Start-charging equipment • Capacitors  
 • Accessories | MARINE AUDIO AND ELECTRONICS — Marine receivers • Marine audio speakers • Marine subwoofers • Marine amplifiers • Accessories | CAR CARE PRODUCTS — Additives • Washer fluid •  
 Care accessories • Car polish • Flavors • Adhesives and sealants | LIQUID AND OIL — Motor oil • Transmission oil • Brake fluid • Antifreeze • Technical lubricant



In store "130" you can find and buy almost all necessary goods for your auto in Kyiv and other cities, delivery by ground and postal services. Our experienced consultants will provide you with exhaustive information and help you to choose the very particular thing. We are waiting for you at the address

<https://130.com.ua>

## KW-M560BT KW-M56BT

MONITOR WITH RECEIVER

### Quick Start Guide

MONITEUR AVEC RÉCEPTEUR

### Guide de démarrage rapide

MONITOR CON RECEPTOR

### Guía de inicio rápido

JVCKENWOOD Corporation

- Updated information (the latest Instruction Manual, system updates, new functions, etc.) is available from
- Des informations actualisées (le dernier mode d'emploi, les mises à jour du système, les nouvelles fonctions, etc.) sont disponibles sur
- Encontrará la información actualizada (el manual de instrucciones más reciente, actualizaciones del sistema, nuevas funciones, etc.) en

<<https://www.jvc.net/cs/car/>>



#### Model name indication position

See **Removing the trim plate (P.25)**

#### Position d'indication du nom du modèle

Reportez-vous à la section **Retrait de la plaque de garniture (p.51)**

#### Posición de la indicación del nombre del modelo

Consulte **Desmontaje de la placa embellecedora (P.77)**

Trim plate  
Plaque de garniture  
Marco

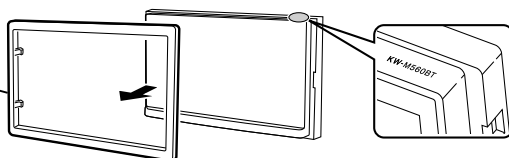

## Important Notice on Software

### Software License on This Product

The software embedded in this product comprises a number of independent software components, each of which is copyrighted by JVCKENWOOD Corporation or by a third party.

This product uses software components that are based on an End-User License Agreement (hereinafter called "EULA") stipulated by JVCKENWOOD Corporation and by third parties.

The EULA dictates the availability of the source codes of free-software components as a prerequisite to distributing them in executable form under the terms of the GNU General Public License or the Lesser General Public License (hereinafter called "GPL/LGPL"). To get information about the software components that are subject to the terms of the GPL/LGPL, please visit the following Website:

Website URL  
<https://www3.jvckenwood.com/english/download/gpl/>

Queries concerning the contents of the source code or the like will not be accepted.

Please note that software components based on a EULA that is not subject to the terms of the GPL/LGPL or those that have been developed or created by JVCKENWOOD Corporation will be excluded from the scope of source code disclosure.

Because licenses to use software components distributed under the GPL/LGPL are offered to the customers for free of charge, no warranty is granted to the customers, whether explicitly or implicitly, to the extent of the applicable laws.

Unless otherwise stipulated by the applicable laws or agreed upon in writing, the copyright holders or those who are entitled to modify and redistribute the software components are not held responsible for any and all damages resulting from their use or from inability to use them. For more information about the terms of use of the software components, required items of compliance and so on, please refer to the GPL/LGPL.

Customers wishing themselves to use a software component that is subject to the GPL/LGPL embedded in this product are encouraged to read the terms of the corresponding license before use. Because each individual license is prescribed by a third party other than JVCKENWOOD Corporation, the original (English) of the license is presented.

## EULA

### Software License Agreement

JVCKENWOOD Corporation (hereinafter called "Licensor") holds either the copyright to the embedded software or the right to sublicense it. This agreement establishes the conditions under which the customer uses this "Licensed Software."

The customer shall agree to the terms of this license agreement before proceeding to use Licensed Software.

This agreement is deemed to have taken effect when the customer (hereinafter called "User") has used a product implementation of Licensed Software.

The Licensed Software may contain software Licensor has been licensed to use by third parties directly or indirectly. Some third parties may have terms of use prescribed for their customers, apart from this Software License Agreement. This agreement does not apply to such software. Be sure to consult "Important Notice on Software" as presented separately.

#### Article 1 (General)

Licensor grants to User a non-exclusive, non-assignable right of use Licensed Software within the country where the User purchases the Product (hereinafter the "Country") (except for the exception provided for in Paragraph 1, Article 3).

#### Article 2 (Right of Use)

1. The rise of use granted under this agreement is the right to use Licensed Software in this product.
2. User may not duplicate, copy, modify, add to, translate or otherwise alter, or loan licensed Software and the associated literature in whole or in part.
3. Use of Licensed Software is limited to a private extent, and Licensed Software may not be distributed, licensed or sublicensed for any purposes whatsoever, including commercial use.
4. User shall use Licensed Software as per the instruction manual or instructions given in the help file and may not use or duplicate data in violation of the regulations of the Copyright Law or other governing laws by using Licensed Software in whole or in part.

### **Article 3 (Terms of License)**

1. In assigning this product, User may not retain the original copy of the embedded Licensed Software (including associated literature, updates and upgrades) and any duplicates and associated literature with regard to the license to use Licensed Software. User may transfer Licensed Software only to the condition of binding the assignee to abide by the terms of this Software License Agreement.
2. User may not reverse-engineer, disassemble, decompile or otherwise analyze the source code of Licensed Software.

### **Article 4 (Rights to Licensed Software)**

All rights to Licensed Software and the associated literature, including copyrights, shall reside with Licensor or the original right holder who has granted the Right of Use and right to sublicense to Licensor (hereinafter referred to as "Original Right Holder"), and User does not have any rights other than Right of Use granted hereunder with regard to Licensed Software and the associated literature.

### **Article 5 (Exemption Granted to Licensor)**

1. Licensor and Original Right Holder do not assume any responsibility for damages caused to User or third parties resulting from the exercise by User of the license granted hereunder, unless otherwise provided by any law to the contrary.
2. Licensor does not warrant Licensed Software to be merchantable, compatible and fit for specific purposes.

### **Article 6 (Responsibility for Third Parties)**

If disputes over the infringement of third parties' intellectual property rights, such as copyrights and patent rights, arise out of the use of Licensed Software by User, User shall resolve these disputes at User's own expenses while keep Licensor and Original Right Holder harmless.

### **Article 7 (Secrecy Obligation)**

User shall keep confidential Licensed Software provided hereunder, information contained in the associated literature or the like and those provisions of this agreement not yet in public knowledge and may not disclose or leak these to third parties without prior written consent from Licensor.

### **Article 8 (Cancellation of the Agreement)**

Licensor reserves the right to cancel this agreement forthwith and claim compensation from User for the damages caused by such cancellation when User:

- (1) Breaches any of the provisions of this agreement, or
- (2) Has received a petition for seizure, provisional seizure, provisional disposition or any other kind of compulsory execution.

### **Article 9 (Destruction of Licensed Software)**

If this agreement is terminated under the provision of the foregoing paragraph, User shall destroy Licensed Software, along with all associated literature and its duplicates, within two (2) weeks from the date of termination.

### **Article 10 (Copyright Protection)**

1. Copyrights and all other intellectual property rights relating to Licensed Software shall reside with Licensor and Original Right Holder and in no circumstances with User.
2. User shall abide by the laws relating to copyrights and intellectual property rights in using Licensed Software.

### **Article 11 (Export Control)**

1. Licensed Software and the associated literature or the like may not be exported to places outside the Country (including transmission outside the Country over the Internet or the like).
2. User agrees that Licensed Software is subject to export controls imposed by the Country and the United States of America.
3. User agrees to comply with all the international and domestic laws that apply to this software (U.S. Export Administration Regulations and regulations established by the U.S., the Country and their governmental agencies regarding usage by end users and export destinations).

### **Article 12 (Miscellaneous)**

1. Even if this agreement is invalidated in part by law, all other provisions shall remain in effect.
2. Licensor and User shall consult each other in good faith to resolve any matters not provided for in this agreement or questions arising from the interpretation of this agreement.
3. Licensor and User agree that this agreement is governed by the law of Japan and that all disputes involving claims and obligations that may arise out of this agreement will be settled by arbitration at the Tokyo District Court as the court of first instance.

# Contents

<b>Before Use</b> .....	<b>4</b>
About the Quick start guide.....	4
How to read this manual.....	4
Precautions.....	5
<b>Basic Operations</b> .....	<b>6</b>
Functions of the Buttons on the Front Panel.....	6
Turning on the Unit.....	6
Getting Started.....	7
Adjusting the volume.....	8
Touch screen operations.....	8
HOME screen descriptions.....	9
Source selection screen descriptions.....	9
Source control screen descriptions.....	11
FUNCTION screen.....	12
List screen.....	12
<b>USB</b> .....	<b>13</b>
Connecting a USB device.....	13
USB Basic Operation.....	13
<b>Tuner</b> .....	<b>14</b>
Tuner Basic Operation.....	14
Memory Operation.....	15
<b>SiriusXM®</b> .....	<b>15</b>
SiriusXM® Basic Operation.....	15
<b>Bluetooth Control</b> .....	<b>17</b>
Register from the Bluetooth device.....	17
Using Hands-Free Unit.....	18
<b>Controlling Audio</b> .....	<b>21</b>
<b>Connection/Installation</b> .....	<b>23</b>
Before Installation .....	23
Installing the unit.....	24
<b>Appendix</b> .....	<b>28</b>
Specifications.....	28
About this Unit.....	28

# Before Use

## About the Quick start guide

This Quick Start Guide describes basic functions of this unit.

For detailed operations and information, refer to the INSTRUCTION MANUAL on the following website:

<<https://www.jvc.net/cs/car/>>

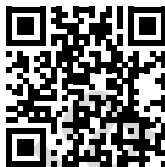

The Instruction manual is subject to change for modification of specifications and so forth.

Be sure to download the latest edition of the Instruction manual for reference.

## How to read this manual

- The screens and panels shown in this manual are examples used to provide clear explanations of the operations. For this reason, they may be different from the actual screens or panels used, or some display patterns may be different.
- **Indication language:** English indications are used for the purpose of explanation. You can select the indication language from the **SETUP** menu. See Instruction Manual.

## Precautions

### ▲ WARNINGS

#### ■ To prevent injury or fire, take the following precautions:

- To prevent a short circuit, never put or leave any metallic objects (such as coins or metal tools) inside the unit.
- Do not watch or fix your eyes on the unit's display when you are driving for any extended period.
- If you experience problems during installation, consult your JVC dealer.

#### ■ Precautions on using this unit

- When you purchase optional accessories, check with your JVC dealer to make sure that they work with your model and in your area.
- You can select language to display menus, audio file tags, etc. See Instruction Manual.
- The Radio Data System or Radio Broadcast Data System feature won't work where the service is not supported by any broadcasting station.

#### ■ Protecting the monitor

- To protect the monitor from damage, do not operate the monitor using a ball point pen or similar tool with the sharp tip.

#### ■ Cleaning the unit

- If the faceplate of this unit is stained, wipe it with a dry soft cloth such as a silicon cloth. If the faceplate is stained badly, wipe the stain off with a cloth moistened with neutral cleaner, then wipe it again with a clean soft dry cloth.

#### NOTE

- Applying spray cleaner directly to the unit may affect its mechanical parts. Wiping the faceplate with a hard cloth or using a volatile liquid such as thinner or alcohol may scratch the surface or erase screened print.

#### ■ How To Reset Your Unit

- If the unit or the connected unit fails to operate properly, reset the unit.1 Press the <Reset> button. The unit returns to factory settings.



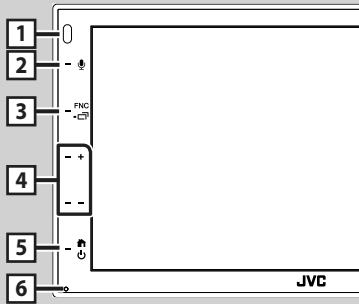

# Basic Operations

## Functions of the Buttons on the Front Panel



### NOTE

- The panels shown in this guide are examples used to provide clear explanations of the operations. For this reason, they may be different from the actual panels.

	<b>Name</b> • <b>Motion</b>
<b>1</b>	Remote Sensor • Receives the remote control signal.
<b>2</b>	 • Displays the Voice Recognition screen.
<b>3</b>	<b>FNC</b> /  • Displays the FUNCTION screen. • Pressing for 1 second displays the APP (Apple CarPlay/ Android Auto) screen.
<b>4</b>	+ , - (Volume) • Adjusts volume. The volume will go up until 15 when you keep pressing +.
<b>5</b>	 • Displays the HOME screen (P.9). • Pressing for 1 second turns the power off. • When the power off, turns the power on.
<b>6</b>	Reset • If the unit or the connected unit fails to operate properly, the unit returns to initial settings when this button is pressed.

## Turning on the Unit

The method of turning on is different depending on the model.

- 1** Press the  button.



- The unit is turned on.

- **To turn off the unit:**

- 1** Press the  button for 1 second.

### NOTE

- If it is your first time turning the unit on after installation, it will be necessary to perform Initial setup (P.7).

## Getting Started

### Initial setup

Perform this setup when you use this unit first time.

#### 1 Set each item as follows.

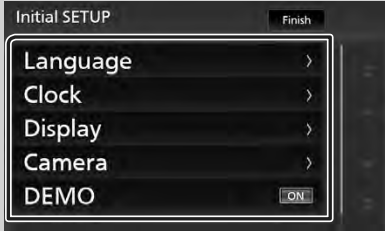

##### ■ Language

Select the language used for the control screen and setting items. Default is "American English(en)".

- ① Touch **Language**.
- ② Touch **Language Select**.
- ③ Select the desired language.
- ④ Touch .

##### ■ Clock

Adjusts clock.

For detailed operation, see **Calendar/clock settings (P.7)**.

##### ■ Display

Set the image on the screen.

- ① Touch **Display**.
- ② Touch **Background**.
- ③ Select the image.
- ④ Touch .

For detailed operation, see Instruction Manual.

##### ■ Camera

Set the parameters for the camera.

- ① Touch **Camera**.
- ② Set each item and touch .

For detailed operation, see Instruction Manual.

##### ■ DEMO

Set the demonstration mode. Default is "ON".

- ① Touch **DEMO** and set **ON** or **OFF**.

#### 2 Touch Finish.



#### NOTE

- These settings can be set from the SETUP menu.

### Calendar/clock settings

#### 1 Press the FNC button.

- FUNCTION screen appears.

#### 2 Touch .



- SETUP Menu screen appears.



**3 Touch User Interface.**



➤ User Interface screen appears.

**4 Touch Clock Adjust.**

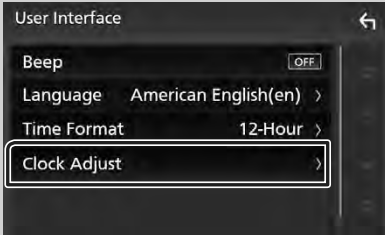

**5 Adjust the date, then adjust the time.**

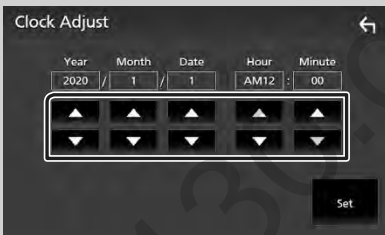

**6 Touch Set.**

**NOTE**

- Deactivate **RDS CT** before adjusting the clock. See Instruction Manual.

**Adjusting the volume**

To adjust the volume (0 to 40), Press + to increase, and press - to decrease. Holding + increases the volume continuously to level 15.



**Touch screen operations**

To perform operations on the screen, you need to touch, touch and hold, flick or swipe to select an item, display setting menu screen or to change the page, etc.

● **Touch**

Touch the screen gently to select an item on the screen.

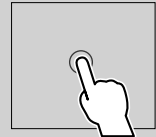

● **Touch and hold**

Touch the screen and keep your finger in place until the display changes or a message is displayed.

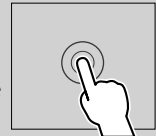

● **Flick**

Slide your finger quickly to the left or right on the screen to change the page.

You can scroll the list screen by flicking the screen up/down.

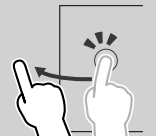

● **Swipe**

Slide your finger up or down on the screen to scroll the screen.

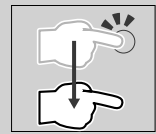

### Gesture Touch Control:

You can also control playback by moving your finger on the touch panel as follows (for some sources, the gesture control is not available).

- Sliding the finger towards up/down:
  - Functions same as pressing **+** / **-** (Media) in the USB Control screen.
  - For the Tuner, tuner preset broadcast stations are switched.
- Sliding the finger towards left/right: Functions same as pressing **◀◀** / **▶▶**.
- Moving your finger clockwise or counter-clockwise: increases/decreases the volume.

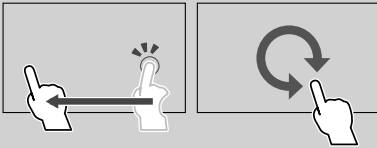

### HOME screen descriptions

Most functions can be performed from the HOME screen.



- |          |   |
|----------|---|
| <b>1</b> | • Short-cut playback source icons. <b>(P.10)</b>  |
| <b>2</b> | • Current source information.<br>• Touch to display the control screen of current source.   |
| <b>3</b> | • Widget  |
| <b>4</b> | • Displays the source selection screen. <b>(P.10)</b>   |
| <b>5</b> | • Displays the SETUP Menu screen.   |
| <b>6</b> | • Displays the Hands Free screen. <b>(P.18)</b><br>• When connecting as Apple CarPlay or Android Auto, it works as a phone provided in Apple CarPlay or Android Auto. |

### Display the HOME screen

- 1** Press the button.

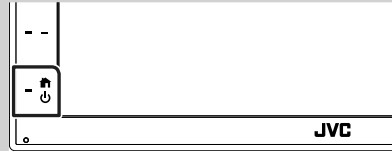

➤ HOME screen appears.

### Source selection screen descriptions

You can display all playback sources and options on the source selection screen.













- |          |  |
|----------|--|
| <b>1</b> | • Changes the playback source.<br>For playback sources, see <b>Select the playback source (P.10)</b> . |
| <b>2</b> | • Returns to previous screen.  |
| <b>3</b> | • Displays the SETUP Menu screen.  |

## Select the playback source

**1** Touch  on the HOME screen.

From the screen, you can select the following sources and functions.

	• Switches to the Apple CarPlay screen from the connected iPhone.
	• Switches to the Android Auto screen from the connected Android smartphone. It is necessary to connect Android smartphone compatible with Android Auto and to set <b>Mode to Android Auto</b> .
	• Switches to the USB Mirroring screen from the connected Android smartphone. It is necessary to connect Android smartphone with "Mirroring OA for JVC" application installed and to set <b>Mode to Mirroring for Android™</b> .
	• Displays the Hands Free screen. <b>(P.18)</b> When neither Apple CarPlay, Android Auto, nor a Bluetooth Hands-Free phone is connected, displays "Disconnected" message in the TEL screen. When connecting as Apple CarPlay or Android Auto, it works as a phone provided in Apple CarPlay or Android Auto.
	• Switches to the Radio broadcast. <b>(P.14)</b>
	• Plays a Bluetooth audio player.
	• Plays files on a USB device. <b>(P.13)</b>
	• Switches to an external component connected to the AV-IN input terminal.
	• Switches to the SiriusXM® satellite radio broadcast. <b>(P.15)</b>
	• Turns off the AV source. <b>(P.10)</b>

## To turn off the AV source

**1** Touch  on the HOME screen.

**2** Touch **AV Off**.



## Source control screen descriptions

There are some functions which can be operated from most screens.

Indicators



Sub menu



Connected Bluetooth device information.



Displays all sources.

**3** **Secondary screen**

- [Left/Right arrow icons]: The Secondary screen changes every time you touch it. You can also change the Secondary screen by flicking left or right on the screen.
- Indicators: Displays the current source condition and so on.
  - **MUTE**: The mute function is active.
  - **LOUD**: The loudness control function is on.
- Sub menu
  - **DIM**: Operation when the icon is touched:  
The first touch darkens the screen, the second touch darkens the screen further, and the third touch restores the screen to its original brightness.
  - [Equalizer icon]: Displays the Graphic Equalizer screen.
  - **(P.22)** [APP icon]: Displays the APP (Apple CarPlay/ Android Auto) screen.



Touch to display the Hands Free screen.

**(P.18)**

When connecting as Apple CarPlay or Android Auto, it works as a phone provided in Apple CarPlay or Android Auto.

## FUNCTION screen

- 1 Press the **FNC** button.



➤ FUNCTION screen appears.

- 2 Touch to display the FUNCTION screen.



The contents of the menu are as follows.

	• Displays the SETUP Menu screen.
	• Displays the APP (Apple CarPlay/Android Auto) screen.
	• Displays the Screen Adjust screen.
	• Displays the view camera.
	• Displays the source selection screen. <b>(P.10)</b>
	• Turns the display off. <b>(P.12)</b>
	• Displays the Audio screen. <b>(P.21)</b>
	• Close the FUNCTION screen.

## Turn off the screen

- 1 Select on the FUNCTION screen.



- To turn on the screen

- 1 Touch the display.

## List screen

There are some common function keys in the list screens of most sources.



- 1 Displays list type selection window.
- 2 Displays music/movie file list.
- 3 **Text scroll**  
Scrolls the displayed text.
- 4 **Play etc.**  
Keys with various functions are displayed here.
  - : Plays all tracks in the folder containing the current track.
  - : Moves to the upper hierarchy.
- 5 **Page scroll**  
You can change the page to display more items by pressing / .
  - / : Displays the top or bottom page.
- 6 **Return**  
Returns to previous screen.

### NOTE

- Buttons which cannot be activated from the list screen are not displayed.

# USB

## Connecting a USB device

- 1 Connect the USB device with the USB cable. (P.26)

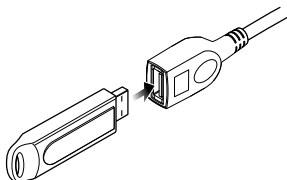

- 2 Press the button.
- 3 Touch .
- 4 Touch **USB**. (P.10)

## Disconnect the USB device

- 1 Press the button.
- 2 Touch .
- 3 Touch a source other than **USB**.
- 4 Detach the USB device.

## Usable USB device

You can use a mass-storage-class USB device on this unit.

The word “USB device” appearing in this manual indicates a flash memory device.

## USB Basic Operation

Most functions can be controlled from the source control screen and playback screen.

### Control screen



- 1 /
  - : Repeats the current track/folder. Each time you touch the key, repeat mode switches in the following sequence; File repeat ( ), Folder repeat ( ), Repeat all ( )
  - : Randomly plays all tracks in current folder. Each time you touch the key, random mode switches in the following sequence; File random ( ), Random off ( )

### 2 Track information

Displays the information of the current file.

### 3 Operation keys

- : Searches track/file. For details on search operation, see Instruction Manual.
- : Searches the previous/next track/file.  
Touch and hold to fast forward or fast backward.
- : Plays or pauses.
- : Touch to mute or not to mute.

# Tuner

## Tuner Basic Operation

Most functions can be controlled from the source control screen.

To enter Tuner source, touch **Tuner** icon in the source selection screen. **(P.10)**

Control screen



Open the drawer



### 1 Information display

Displays the information of the current station:  
Frequency

Touching allows you to switch between Content A and Content B.

- Content A: PS name, Radio Text, PTY Genre
- Content B: Radio Text plus, Title Artist

**Preset#**: Preset number

### 2 Seek mode

Switches the seek mode in the following sequence; **AUTO1**, **AUTO2**, **MANUAL**.

- **AUTO1**: Tunes in a station with good reception automatically.
- **AUTO2**: Tunes in stations in memory one after another.
- **MANUAL**: Switches to the next frequency manually.

### 3 Operation keys

- : Tunes in a station. The method of frequency switching can be changed (see 2 in table).
- : Touch to mute or not to mute.

### 4 Preset list

- Touch on the right side of the screen to display the Preset list. Touch again to close the list.
- Recalls the memorized station.
- When touched for 2 seconds, stores the current receiving station in memory.

### 5 Function panel

Touch on the left side of the screen to display the function panel. Touch again to close the panel.

- **TI** (FM only): Sets the traffic information mode on. For details, see Instruction Manual.
- **SETUP**: Displays the Tuner SETUP screen. For details, see Instruction Manual.
- **AME**: Presets stations automatically. For details, see Instruction Manual.
- **PTY** (FM only): Searches a program by setting program type. For details, see Instruction Manual.
- **MONO** (FM only): Select the Monaural reception.

### 6 FM AM

Switches the band.

### 7 Indicator Items

- **ST**: A stereo broadcast is being received.
- **MONO**: The forced monaural function is on.
- **TI**: Indicates the reception state of traffic information.
  - White: TP is being received.
  - Orange: TP is not being received.

## Memory Operation

### Auto memory

You can store stations with good reception in memory automatically.

#### 1 Touch desired band key.



#### 2 Touch **▶** on the left side of the screen. Touch **AME**.

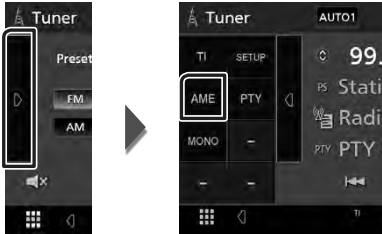

➤ A confirmation screen appears.

#### 3 Touch **Yes**.

➤ Auto memory starts.

### Manual memory

You can store the current receiving station in memory.

#### 1 Select a station you wish to store in memory.

#### 2 Touch **FM#** (#: 1-24) or **AM#** (#: 1-12) in which you want to store the station for 2 seconds.

## SiriusXM®

### SiriusXM® Basic Operation

Only SiriusXM® brings you more of what you love to listen to, all in one place. Get over 140 channels, including commercial-free music plus the best sports, news, talk, comedy and entertainment. Welcome to the world of satellite radio. A SiriusXM Vehicle Tuner and Subscription are required. For more information, visit [www.siriusxm.com](http://www.siriusxm.com).

To listen to the SiriusXM source, touch the **SiriusXM** icon on the source selection screen. **(P.10)**

#### Activating subscription

- Check your Radio ID.  
The SiriusXM Satellite Radio ID is required for activation and can be found by tuning in Channel 0 as well as on the label found on the SiriusXM Connect tuner and its package. The Radio ID does not include the letters I, O, S or F.
- Activate the SiriusXM Connect Vehicle Tuner using either one of the two methods below:
  - For users in U.S.A.  
Online: Visit [www.siriusxm.com/activatenow](http://www.siriusxm.com/activatenow)  
Phone:  
Call SiriusXM Listener Care at 1-866-635-2349
  - For users in Canada:  
Online: Visit  
<https://www.siriusxm.ca/help/activation-help/>  
Phone:  
Call XM customer Care at 1-877-438-9677

#### NOTE

- To use SiriusXM® Satellite Radio, the optional accessory is necessary.



**Control screen**



**Open the drawer**



**1 Information display**

- Displays the information on the current channel: Channel Name  
**P#** : Preset number  
**#CH**: Channel number  
 Touching allows you to switch between Content A and Content B.
  - Content A: Artist Name, Song Title
  - Content B: Content Info, Category Name

**NOTE**

- While getting contents, "Waiting" is showing on the display.

**2 Band button**

Switches among bands. (SXM1/SXM2/SXM3)

**3 Artwork / Function panel**

- Displays the album artwork for most SiriusXM music channels.
- Touch of the screen to display the function panel. Touch to close the panel.
  - **Direct Channel**: Touch and enter the desired number. For details, see Instruction Manual.
  - **SETUP**: Touch to display the SiriusXM SETUP screen. For details, see Instruction Manual.
  - **Replay/Live**: Touch to turn on or off the replay mode. See Instruction Manual.

**4 Operation keys**

- : Display the Category search screen. For details on search operation, see Instruction Manual.
- : Plays or pauses. See Instruction Manual.
- **CH▼ CH▲** : Selects a channel.
- : Touch to mute or not to mute.

**5 Preset list**

- Touch of the screen to display the preset list. Touch to close the list.
- Recalls the memorized channel.
- When touched for 2 seconds, stores the currently being received channel in the memory.

# Bluetooth Control

## About the cell-phone and Bluetooth audio player

This unit conforms to the following Bluetooth specifications:

Version

Bluetooth Ver. 4.1

Profile

Cell-phone:

HFP (Hands Free Profile)

SPP (Serial Port Profile)

PBAP (Phonebook Access Profile)

Audio player:

A2DP (Advanced Audio Distribution Profile)

AVRCP (Audio/Video Remote Control Profile)

Sound codec

SBC, AAC

### NOTE

- The units supporting the Bluetooth function have been certified for conformity with the Bluetooth Standard following the procedure prescribed by Bluetooth SIG.
- However, it may be impossible for such units to communicate with your cell-phone depending on its type.

## Register from the Bluetooth device

It is necessary to register the Bluetooth audio player or cell-phone to this unit before using the Bluetooth function.

- 1 Turn on the Bluetooth function on your smartphone/cell-phone.
- 2 Search the unit ("KW-M\*\*\*\*\*") from your smartphone/cell-phone.
- 3 Operate your smartphone/cell-phone according to the displayed messages.
  - Confirm the request on the smartphone/cell-phone.



- If a PIN code is required, enter the PIN code ("0000").

- 4 Press the **FNC** button.
  - FUNCTION screen appears.

- 5 Touch .



- SETUP Menu screen appears.

- 6 Touch **Bluetooth**.



- Bluetooth SETUP screen appears.

## Bluetooth Control

### 7 Touch **Select Device** in the Bluetooth SETUP screen.



### 8 Touch **[C >]** you want to connect.



#### NOTE

- If the icon is lighted, it means that the unit will use that device.

### To delete the registered Bluetooth device

#### 1 Touch **Delete**.

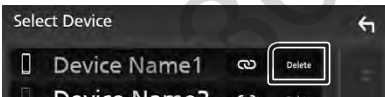

➤ Confirmation message appears.

#### 2 Touch **Yes**.

## Using Hands-Free Unit

You can use telephone function by connecting the Bluetooth telephone to this unit.

#### NOTE

- While Apple CarPlay or Android Auto is being connected, Bluetooth Hands-Free function cannot be used. Only Apple CarPlay or Android Auto Hands-Free function can be used.

### Make a call

#### 1 Touch **Phone**.



➤ Hands Free screen appears.

#### 2 Select a dialing method.



- : Call using call records
- : Call using the phonebook
- : Call using the preset number
- : Call by entering a phone number
- : Voice Recognition
- : Bluetooth SETUP

#### ● Bluetooth SETUP

##### 1) Touch **[Phone]**.

Bluetooth SETUP screen appears.

#### NOTE

- The status icons such as battery and antenna displayed may differ from those displayed on the cell-phone.
- Setting the cell-phone in the private mode can disable the hands-free function.

**Call using call records**

- 1 Touch .
- 2 Select the phone number from the list.

**Call by entering a phone number**

- 1 Touch .
- 2 Enter a phone number with number keys.



- 3 Touch .

**Call using the preset number**

- 1 Touch .
- 2 Touch the Name or phone number.

**Call using the phonebook**

- 1 Touch .
- 2 Select the person you want to call from the list.

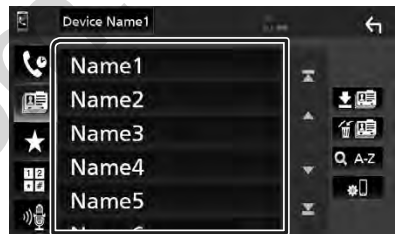

- 3 Select the phone number from the list.

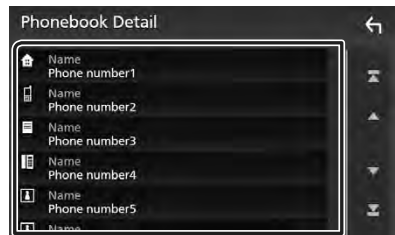
**NOTE**

- If no Phonebook has been downloaded, touching **Download Phonebook Now** will start downloading the Phonebook.

### Receive a call

- 1 Touch to answer a phone call or to reject an incoming call.



#### NOTE

- While monitoring the view camera, this screen does not appear even if a call comes in. To display this screen, return the shift knob of car to the driver position.

### To end call

- 1 While talking, touch .

### Operations during a call



#### ● Adjust the receiver volume

Press the or button.



#### ● Output the dial tone

Touch **DTMF** to display the tone input screen. You can send tones by touching desired keys on the screen.

#### ● Switching the speaking voice output

Touching / each time switches the speaking voice output between cell-phone and speaker.

#### ● Call-waiting

When you receive a call while talking on another call, you can answer the newly received call by touching . The current call is on hold. Each time you touch , the caller will change. When you touch , the current call will end and switch to the call in hold.

# Controlling Audio

You can adjust the various settings such as audio balance or subwoofer level.

- 1 Press the **FNC** button.  
➤ FUNCTION screen appears.
- 2 Touch .

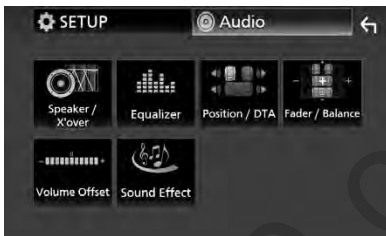

## Controlling General Audio

- 1 Press the **FNC** button.  
➤ FUNCTION screen appears.
- 2 Touch .
- 3 Touch **Fader / Balance**.

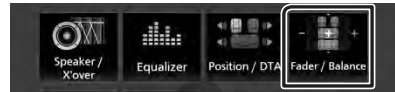

- 4 Set each item as follows.

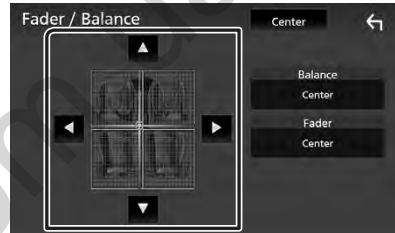

### ■ Fader / Balance

Adjust the volume balance around the touched area.

◀ and ▶ adjust the right and left volume balance.

▲ and ▼ adjust the front and rear volume balance.

### ■ Center

Clear the adjustment.

## Controlling Audio

### ■ Equalizer Control

You can adjust equalizer by selecting the optimized setting for each category.

#### 1 Press the **FNC** button.

➤ **FUNCTION** screen appears.

#### 2 Touch .

➤ **Audio** screen appears.

#### 3 Touch **Equalizer**.



#### 4 Touch the screen and set the **Graphic Equalizer** as desired.

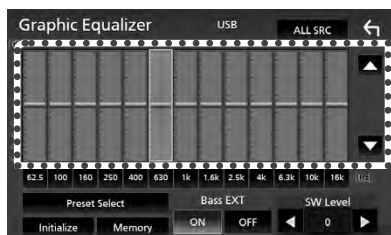

#### ■ **ALL SRC**

Apply the adjusted equalizer to all sources.

Touch **ALL SRC** and then touch **OK** on the confirmation screen.

#### ■ **Gain level (dotted frame area)**

Adjust the gain level by touching the each frequency bar.

You can select frequency bar and adjust its level by ▲, ▼.

#### ■ **Preset Select**

Displays the screen to recall the preset equalizer curve.

#### ■ **Initialize**

The current EQ curve returns to flat.

#### ■ **Memory**

Saves the adjusted equalizer curve from "User1" to "User3".

#### ■ **Bass EXT (Bass Extend Settings)**

When turned on, the frequency lower than 62.5 Hz is set to the same gain level as 62.5 Hz.

#### ■ **SW Level**

Adjusts the subwoofer volume.

# Connection/Installation

## Before Installation

Before installation of this unit, please note the following precautions.

### ▲ WARNINGS

- If you connect the ignition wire (red) and the battery wire (yellow) to the car chassis (ground), you may cause a short circuit, that in turn may start a fire. Always connect those wires to the power source running through the fuse box.
- Do not cut out the fuse from the ignition wire (red) and the battery wire (yellow). The power supply must be connected to the wires via the fuse.

### ▲ CAUTION

- Install this unit in the console of your vehicle. Do not touch the metal part of this unit during and shortly after the use of the unit. Metal part such as the heat sink and enclosure become hot.

### NOTE

- Mounting and wiring this product requires skills and experience. For best safety, leave the mounting and wiring work to professionals.
- Make sure to ground the unit to a negative 12V DC power supply.
- Do not install the unit in a spot exposed to direct sunlight or excessive heat or humidity. Also avoid places with too much dust or the possibility of water splashing.
- Do not use your own screws. Use only the screws provided. If you use the wrong screws, you could damage the unit.
- If the power is not turned ON ("There is an error in the speaker wiring. Please check the connections." is displayed), the speaker wire may have a short-circuit or touched the chassis of the vehicle and the protection function may have been activated. Therefore, the speaker wire should be checked.
- If your car's ignition does not have an ACC position, connect the ignition wires to a power source that can be turned on and off with the ignition key. If you connect the ignition wire

to a power source with a constant voltage supply, such as with battery wires, the battery may be drained.



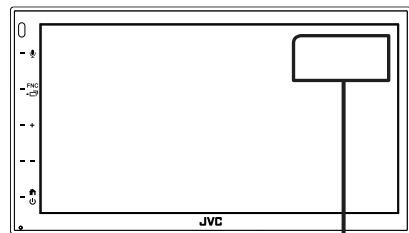





- If the console has a lid, make sure to install the unit so that the front panel will not hit the lid when closing and opening.
- If the fuse blows, first make sure the wires aren't touching to cause a short circuit, then replace the old fuse with one with the same rating.
- Insulate unconnected wires with vinyl tape or other similar material. To prevent a short circuit, do not remove the caps on the ends of the unconnected wires or the terminals.
- Connect the speaker wires correctly to the terminals to which they correspond. The unit may be damaged or fail to work if you share the ⊖ wires or ground them to any metal part in the car.
- When only two speakers are being connected to the system, connect the connectors either to both the front output terminals or to both the rear output terminals (do not mix front and rear). For example, if you connect the ⊕ connector of the left speaker to a front output terminal, do not connect the ⊖ connector to a rear output terminal.
- After the unit is installed, check whether the brake lamps, blinkers, wipers, etc. on the car are working properly.
- Do not press hard on the panel surface when installing the unit to the vehicle. Otherwise scars, damage, or failure may result.
- Reception may drop if there are metal objects near the Bluetooth antenna.

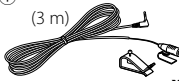

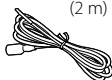
Bluetooth antenna unit

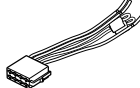
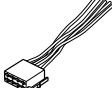

### Supplied accessories for installation

① (3 m)  x1	②  x1
③ (2 m)  x1	④  x1
⑤  (M5 × 6 mm) x6	⑥  (M5 × 8 mm) x6
⑦  x1	⑧  x1
⑨  x2	

### Installation procedure

- 1) To prevent a short circuit, remove the key from the ignition and disconnect the  $\ominus$  terminal of the battery.
- 2) Make the proper input and output wire connections for each unit.
- 3) Connect the wire on the wiring harness.
- 4) Take Connector B (accessory ⑧) on the wiring harness and connect it to the speaker connector in your vehicle.
- 5) Take Connector A (accessory ⑦) on the wiring harness and connect it to the external power connector on your vehicle.
- 6) Connect the wiring harness connector to the unit.
- 7) Install the unit in your car.
- 8) Reconnect the  $\ominus$  terminal of the battery.
- 9) Press the reset button.

### Installing the unit

#### Non-Japanese cars

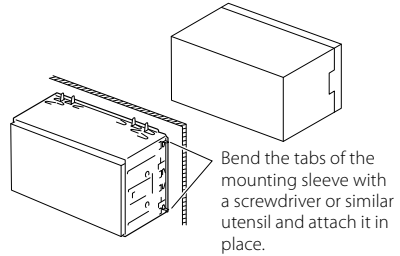

#### NOTE

- Make sure that the unit is installed securely in place. If the unit is unstable, it may malfunction (eg, the sound may skip).

#### Japanese cars

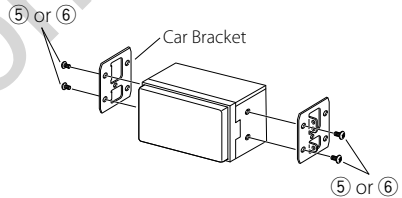

#### Trim plate

- 1) Attach accessory ② to the unit.

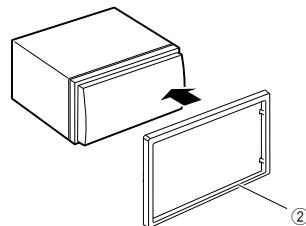

## Microphone unit

- 1) Check the installation position of the microphone (accessory ①).
- 2) Clean the installation surface.
- 3) Remove the separator of the microphone (accessory ①), and stick the microphone to the place shown below.
- 4) Wire the microphone cable up to the unit with it secured at several positions using tape or other desired method.
- 5) Adjust the direction of the microphone (accessory ①) to the driver.

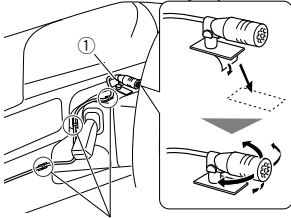

Fix a cable with a commercial item of tape.

### NOTE

- Swap the clips if necessary.

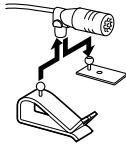

## Removing the trim plate

- 1) Use the extraction key (accessory ④) to lever out the four tabs (two on the left part, two on the right part).

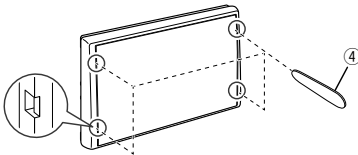

- 2) Pull the trim plate forward.

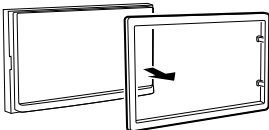

## Removing the unit

- 1) Remove the trim plate by referring to step 1 in "Removing the trim plate".
- 2) Insert the extraction key (accessory ⑨) deeply into the slot as shown. (The protrusion at the tip of the extraction key must face toward the unit.)

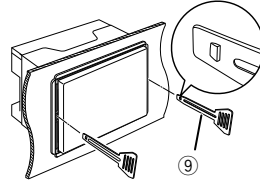

- 3) With the inserted extraction key secured, insert the other extraction key into the slot.

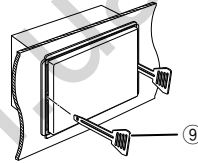

- 4) Pull out the unit halfway.

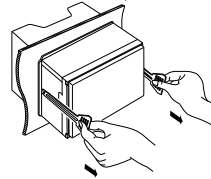

### NOTE

- Be careful to avoid injury from the catch pins on the extraction key.

- 5) Pull the unit all the way out with your hands, being careful not to drop it.

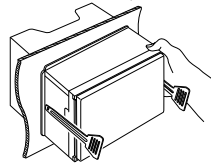

## Connecting wires to terminals

Light Blue/Yellow (Steering remote control wire)

To steering remote  
To use the steering wheel remote control feature, you need an exclusive remote adapter (not supplied) matched to your car.

Light Green (Parking sensor wire)  
Accessory ③: Parking Extension cable

Connect to the vehicle's parking brake detection switch harness.

For best safety, be sure to connect the parking sensor.

Purple/White (Reverse sensor wire)

Connect to vehicle's reverse lamp harness when using the optional rear view camera.

Connector A  
Connector B  
Fuse (15A)

Accessory ⑦  
Accessory ⑧

USB terminal<sup>[1]</sup> (1.0 m)

USB device<sup>[2]</sup>

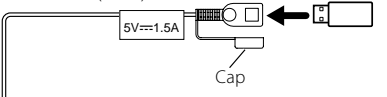

Subwoofer Preout



SiriusXM Connect Vehicle Tuner connector

For more information on how to install the SiriusXM Connect Vehicle tuner, consult the installation guide included with the tuner.

Accessory ①: Bluetooth Microphone

FM/AM antenna

AV-IN (1; Left audio, 2; Composite video, 3; Ground, 4; Right audio).

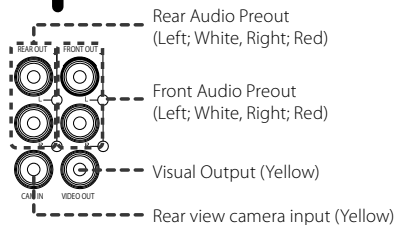

[1] USB maximum power supply current : DC 5 V = 1.5 A

[2] Sold separately

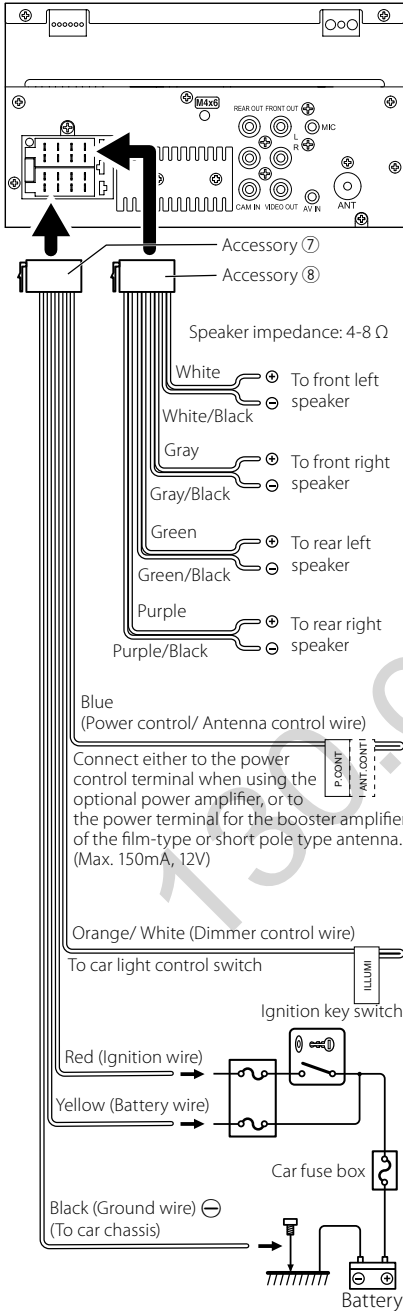

### Connecting an iPhone/Android

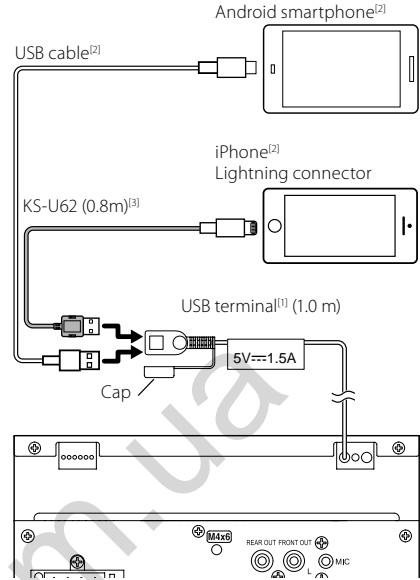

- <sup>[1]</sup> iPhone maximum power supply current : DC 5 V --- 1.5 A
- <sup>[2]</sup> Sold separately
- <sup>[3]</sup> Optional accessory

# Appendix

## Specifications

### Bluetooth section

Frequency

: 2.402 – 2.480 GHz

RF Output Power (E.I.R.P.)

: +8 dBm (Avg.), Power Class 1

### General

Operating Voltage

: 12V DC Car Battery

Speaker Impedance

: 4 – 8  $\Omega$

**Specifications subject to change without notice.**

## About this Unit

### Copyrights

- The Bluetooth® word mark and logos are registered trademarks owned by Bluetooth SIG, Inc. and any use of such marks by JVCケンウッド Corporation is under license. Other trademarks and trade names are those of their respective owners.
- Windows Media is a registered trademark or trademark of Microsoft Corporation in the United States and/or other countries.
- This product is protected by certain intellectual property rights of Microsoft. Use or distribution of such technology outside of this product is prohibited without a license from Microsoft.
- Use of the Made for Apple badge means that an accessory has been designed to connect specifically to the Apple product(s) identified in the badge, and has been certified by the developer to meet Apple performance standards. Apple is not responsible for the operation of this device or its compliance with safety and regulatory standards. Please note that the use of this accessory with an Apple product may affect wireless performance.
- Apple, iPhone and Lightning are trademarks of Apple Inc., registered in the U.S. and other countries.
- Apple, Siri, Apple CarPlay and Apple CarPlay logo are trademarks of Apple Inc., registered in the U.S. and other countries.
- App Store is a service mark of Apple Inc., registered in the U.S. and other countries.
- Sirius, XM and all related marks and logos are trademarks of Sirius XM Radio Inc. All rights reserved.
- IOS is a trademark or registered trademark of Cisco in the U.S. and other countries and is used under license.
- Google, Android, Google Play and Android Auto are trademarks of Google LLC.
- To use Android Auto on your car display, you'll need an Android Auto compatible vehicle or aftermarket stereo, an Android phone running Android 5.0 or higher, and the Android Auto app.
- Linux® is the registered trademark of Linus Torvalds in the U.S. and other countries.
- THIS PRODUCT IS LICENSED UNDER THE AVC PATENT PORTFOLIO LICENSE FOR THE PERSONAL USE OF A CONSUMER OR OTHER USES IN WHICH IT DOES NOT RECEIVE REMUNERATION TO (i) ENCODE VIDEO IN COMPLIANCE WITH THE AVC STANDARD ("AVC VIDEO") AND/OR (ii) DECODE AVC VIDEO THAT WAS ENCODED BY A CONSUMER ENGAGED IN A PERSONAL ACTIVITY AND/OR WAS OBTAINED FROM A VIDEO PROVIDER LICENSED TO PROVIDE AVC VIDEO. NO LICENSE IS GRANTED OR SHALL BE IMPLIED FOR ANY OTHER USE. ADDITIONAL INFORMATION MAY BE OBTAINED FROM MPEG LA, L.L.C. SEE [HTTP://WWW.MPEGLA.COM](http://www.MPEGLA.COM)

- THIS PRODUCT IS LICENSED UNDER THE MPEG-4 VISUAL PATENT PORTFOLIO LICENSE FOR THE PERSONAL AND NON-COMMERCIAL USE OF A CONSUMER FOR (i) ENCODING VIDEO IN COMPLIANCE WITH THE MPEG-4 VISUAL STANDARD ("MPEG-4 VIDEO") AND/OR (ii) DECODING MPEG-4 VIDEO THAT WAS ENCODED BY A CONSUMER ENGAGED IN A PERSONAL AND NON-COMMERCIAL ACTIVITY AND/OR WAS OBTAINED FROM A VIDEO PROVIDER LICENSED BY MPEG LA TO PROVIDE MPEG-4 VIDEO. NO LICENSE IS GRANTED OR SHALL BE IMPLIED FOR ANY OTHER USE. ADDITIONAL INFORMATION INCLUDING THAT RELATING TO PROMOTIONAL, INTERNAL AND COMMERCIAL USES AND LICENSING MAY BE OBTAINED FROM MPEG LA, L.L.C. SEE [HTTP://WWW.MPEGLA.COM](http://www.mpegla.com).

- THIS PRODUCT IS LICENSED UNDER THE VC-1 PATENT PORTFOLIO LICENSE FOR THE PERSONAL AND NON-COMMERCIAL USE OF A CONSUMER TO (i) ENCODE VIDEO IN COMPLIANCE WITH THE VC-1 STANDARD ("VC-1 VIDEO") AND/OR (ii) DECODE VC-1 VIDEO THAT WAS ENCODED BY A CONSUMER ENGAGED IN A PERSONAL AND NON-COMMERCIAL ACTIVITY AND/OR WAS OBTAINED FROM A VIDEO PROVIDER LICENSED TO PROVIDE VC-1 VIDEO. NO LICENSE IS GRANTED OR SHALL BE IMPLIED FOR ANY OTHER USE. ADDITIONAL INFORMATION MAY BE OBTAINED FROM MPEG LA, L.L.C. SEE [HTTP://WWW.MPEGLA.COM](http://www.mpegla.com)

- libFLAC

Copyright (C) 2000,2001,2002,2003,2004,2005,2006,2007,2008,2009 Josh Coalson

Redistribution and use in source and binary forms, with or without modification, are permitted provided that the following conditions are met:

- Redistributions of source code must retain the above copyright notice, this list of conditions and the following disclaimer.
- Redistributions in binary form must reproduce the above copyright notice, this list of conditions and the following disclaimer in the documentation and/or other materials provided with the distribution.
- Neither the name of the Xiph.org Foundation nor the names of its contributors may be used to endorse or promote products derived from this software without specific prior written permission.

THIS SOFTWARE IS PROVIDED BY THE COPYRIGHT HOLDERS AND CONTRIBUTORS "AS IS" AND ANY EXPRESS OR IMPLIED WARRANTIES, INCLUDING, BUT NOT LIMITED TO, THE IMPLIED WARRANTIES OF MERCHANTABILITY AND FITNESS FOR A PARTICULAR PURPOSE ARE DISCLAIMED. IN NO EVENT SHALL THE FOUNDATION OR CONTRIBUTORS BE LIABLE FOR ANY DIRECT, INDIRECT, INCIDENTAL, SPECIAL, EXEMPLARY, OR CONSEQUENTIAL DAMAGES (INCLUDING, BUT NOT LIMITED TO, PROCUREMENT OF SUBSTITUTE GOODS OR SERVICES; LOSS OF USE, DATA, OR PROFITS; OR BUSINESS INTERRUPTION) HOWEVER CAUSED AND ON ANY THEORY OF LIABILITY, WHETHER IN CONTRACT, STRICT LIABILITY, OR TORT (INCLUDING NEGLIGENCE OR OTHERWISE) ARISING IN ANY WAY OUT OF THE USE OF THIS SOFTWARE, EVEN IF ADVISED OF THE POSSIBILITY OF SUCH DAMAGE.

- libvorbis

Copyright (c) 2002-2008 Xiph.org Foundation

Redistribution and use in source and binary forms, with or without modification, are permitted provided that the following conditions are met:

- Redistributions of source code must retain the above copyright notice, this list of conditions and the following disclaimer.
- Redistributions in binary form must reproduce the above copyright notice, this list of conditions and the following disclaimer in the documentation and/or other materials provided with the distribution.
- Neither the name of the Xiph.org Foundation nor the names of its contributors may be used to endorse or promote products derived from this software without specific prior written permission.

THIS SOFTWARE IS PROVIDED BY THE COPYRIGHT HOLDERS AND CONTRIBUTORS "AS IS" AND ANY EXPRESS OR IMPLIED WARRANTIES, INCLUDING, BUT NOT LIMITED TO, THE IMPLIED WARRANTIES OF MERCHANTABILITY AND FITNESS FOR A PARTICULAR PURPOSE ARE DISCLAIMED. IN NO EVENT SHALL THE FOUNDATION OR CONTRIBUTORS BE LIABLE FOR ANY DIRECT, INDIRECT, INCIDENTAL, SPECIAL, EXEMPLARY, OR CONSEQUENTIAL DAMAGES (INCLUDING, BUT NOT LIMITED TO, PROCUREMENT OF SUBSTITUTE GOODS OR SERVICES; LOSS OF USE, DATA, OR PROFITS; OR BUSINESS INTERRUPTION) HOWEVER CAUSED AND ON ANY THEORY OF LIABILITY, WHETHER IN CONTRACT, STRICT LIABILITY, OR TORT (INCLUDING NEGLIGENCE OR OTHERWISE) ARISING IN ANY WAY OUT OF THE USE OF THIS SOFTWARE, EVEN IF ADVISED OF THE POSSIBILITY OF SUCH DAMAGE.

- libogg

Copyright (c) 2002, Xiph.org Foundation Redistribution and use in source and binary forms, with or without modification, are permitted provided that the following conditions are met:

- Redistributions of source code must retain the above copyright notice, this list of conditions and the following disclaimer.
- Redistributions in binary form must reproduce the above copyright notice, this list of conditions and the following disclaimer in the documentation and/or other materials provided with the distribution.
- Neither the name of the Xiph.org Foundation nor the names of its contributors may be used to endorse or promote products derived from this software without specific prior written permission.

THIS SOFTWARE IS PROVIDED BY THE COPYRIGHT HOLDERS AND CONTRIBUTORS "AS IS" AND ANY EXPRESS OR IMPLIED WARRANTIES, INCLUDING, BUT NOT LIMITED TO, THE IMPLIED WARRANTIES OF MERCHANTABILITY AND FITNESS FOR A PARTICULAR PURPOSE ARE DISCLAIMED. IN NO EVENT SHALL THE FOUNDATION OR CONTRIBUTORS BE LIABLE FOR ANY DIRECT, INDIRECT, INCIDENTAL, SPECIAL, EXEMPLARY, OR CONSEQUENTIAL DAMAGES (INCLUDING, BUT NOT LIMITED TO, PROCUREMENT OF SUBSTITUTE GOODS OR SERVICES; LOSS OF USE, DATA, OR PROFITS; OR BUSINESS INTERRUPTION) HOWEVER CAUSED AND ON ANY THEORY OF LIABILITY, WHETHER IN CONTRACT, STRICT LIABILITY, OR TORT (INCLUDING NEGLIGENCE OR OTHERWISE) ARISING IN ANY WAY OUT OF THE USE OF THIS SOFTWARE, EVEN IF ADVISED OF THE POSSIBILITY OF SUCH DAMAGE.

## Table des matières

Avant l'utilisation.....	30
À propos du guide de démarrage rapide.....	30
Comment lire ce manuel.....	30
Précautions.....	31
<b>Utilisation de base.....</b>	<b>32</b>
Fonctions des boutons en façade.....	32
Mise en marche de l'appareil.....	32
Mise en route.....	33
Régler le volume.....	34
Fonctionnement tactile.....	34
Descriptions de l'écran d'ACCUEIL.....	35
Descriptions de l'écran de sélection de source.....	35
Descriptions de l'écran de commande de source.....	37
Écran FONCTION.....	38
Écran des listes.....	38
<b>USB.....</b>	<b>39</b>
Connecter un périphérique USB.....	39
Utilisation de base USB.....	39
<b>Tuner.....</b>	<b>40</b>
Utilisation de base de la radio.....	40
Utilisation de la mémorisation.....	41
<b>SiriusXM®.....</b>	<b>41</b>
Utilisation de base de SiriusXM®.....	41
<b>Utilisation du Bluetooth.....</b>	<b>43</b>
Enregistrez depuis le périphérique Bluetooth.....	43
Utilisation du module mains-libres.....	44
<b>Contrôle de l'audio.....</b>	<b>47</b>
<b>Connexion/Installation.....</b>	<b>49</b>
Avant l'installation.....	49
Installation de l'appareil.....	50
<b>Annexes.....</b>	<b>54</b>
Spécifications.....	54
À propos de cet appareil.....	54

## Avant l'utilisation

### À propos du guide de démarrage rapide

Ce Guide de démarrage rapide décrit les fonctions de base de cet appareil. Pour plus d'informations et de détails sur les opérations, reportez-vous au MODE D'EMPLOI sur le site Internet suivant :

<<https://www.jvc.net/cs/car/>>

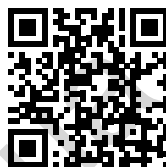

Le mode d'emploi est susceptible d'être modifié suite aux changements pouvant être apportés aux spécifications etc.

Téléchargez impérativement la dernière édition du mode d'emploi aux fins de référence.

### Comment lire ce manuel

- Les écrans et façades illustrés dans le présent manuel sont des exemples destinés à fournir des explications plus claires des opérations. C'est pourquoi il est possible qu'ils soient différents des écrans effectivement affichés ou de la façade de l'appareil, ou que certaines séquences d'affichage soient différentes.
- **Langue des indications** : Les indications en anglais sont utilisées dans un but explicatif. Vous pouvez choisir la langue des indications à partir du menu **SETUP**. Voir le Mode d'emploi.

## Précautions

### ▲ AVERTISSEMENTS

#### ■ Pour éviter toute blessure ou incendie, prenez les précautions suivantes :

- Pour éviter un court-circuit, ne mettez ni ne laissez jamais d'objets métalliques (comme des pièces de monnaie ou des outils en métal) à l'intérieur de l'appareil.
- Ne regardez pas ni ne fixez votre regard sur l'affichage de l'appareil trop longtemps pendant la conduite.
- Si vous rencontrez des problèmes pendant l'installation, consultez votre revendeur JVC.

#### ■ Précautions d'utilisation de l'appareil

- Lorsque vous achetez des accessoires en option, vérifiez auprès de votre revendeur JVC qu'ils fonctionneront avec votre modèle et dans votre région.
- Vous avez le choix de la langue dans laquelle s'affichent les menus, les balises des fichiers audio, etc. Voir le Mode d'emploi.
- Les fonctions Radio Data System ou Radio Broadcast Data System sont inopérantes dans les zones où le service n'est pris en charge par aucune station de radiodiffusion.

#### ■ Protection du moniteur

- Ne touchez pas le moniteur avec un stylo à bille ou tout autre outil pointu. Cela pourrait l'endommager.

#### ■ Nettoyage de l'appareil

- Si la façade de l'appareil est tâchée, essuyez-la avec un chiffon doux et sec comme un chiffon en silicone. Si la façade est très sale, essuyez-la avec un chiffon imbibé d'un produit de nettoyage neutre, puis essuyez-la à nouveau avec un chiffon doux et sec propre.

### REMARQUE

- La pulvérisation directe de produit de nettoyage sur l'appareil risque d'endommager les pièces mécaniques. Si vous nettoyez la façade avec un chiffon trop rugueux ou un liquide volatil, comme un solvant ou de l'alcool, vous risquez d'en rayer la surface ou d'effacer les caractères sérigraphiés.

#### ■ Comment réinitialiser votre appareil

- Si l'appareil ou l'appareil raccordé ne fonctionne pas correctement, réinitialisez l'appareil. 1 Appuyez sur le bouton <Reset>. L'appareil revient aux réglages d'usine.



Bouton de réinitialisation





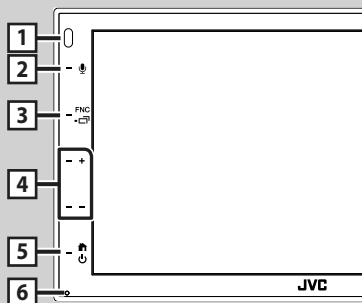

# Utilisation de base

## Fonctions des boutons en façade



### REMARQUE

- Les écrans illustrés dans le présent guide sont des exemples destinés à fournir des explications plus claires des opérations. Pour cette raison, il peut arriver qu'ils soient différents de ceux rencontrés dans la réalité.

	Désignation • <b>Mouvement</b>
1	Capteur de télécommande • Reçoit le signal de la télécommande.
2	 • Affiche l'écran de reconnaissance vocale.
3	<b>FNC</b> /  • Affiche l'écran FONCTION. • Appuyez pendant 1 seconde pour afficher l'écran APP (Apple CarPlay/Android Auto).
4	+ , - (Volume) • Règle le volume. Le volume augmentera jusqu'à 15 tant que vous maintiendrez + enfoncé.
5	 /  • Affiche l'écran d'ACCUEIL (p.35). • Appuyez pendant 1 seconde pour éteindre l'appareil. • Quand l'appareil est éteint, permet de le mettre en marche.
6	Réinitialisation • Si l'appareil ou l'appareil qui y est connecté ne fonctionne pas correctement, appuyez sur ce bouton pour que l'appareil retrouve les réglages initiaux.

## Mise en marche de l'appareil

La méthode d'allumage est différente selon le modèle.

- 1 Appuyez sur le bouton .

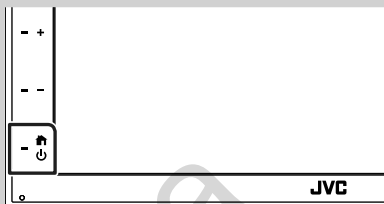

> L'appareil se met en marche.

- Pour éteindre l'appareil :

- 1 Appuyez sur le bouton  pendant 1 seconde.

### REMARQUE

- Si c'est la première fois que vous mettez en marche l'appareil après son installation, il vous faut procéder à la Configuration initiale (p.33).

## Mise en route

### Configuration initiale

Effectuez cette configuration lors de la première utilisation de cet appareil.

#### 1 Réglez chaque option comme suit.



##### ■ Language

Sélectionne la langue utilisée sur l'écran de commande et sur les éléments de configuration. Le choix par défaut est « **American English(en)** ».

- ① Touchez **Language**.
- ② Touchez **Language Select**.
- ③ Sélectionnez la langue désirée.
- ④ Touchez **↩**.

##### ■ Clock

Règle l'horloge.

Pour les explications détaillées, voir **Réglages du calendrier/horloge (p.33)**.

##### ■ Display

Réglez l'image à l'écran.

- ① Touchez **Display**.
- ② Touchez **Background**.
- ③ Sélectionnez l'image.
- ④ Touchez **↩**.

Pour les explications détaillées, voir le Mode d'emploi.

##### ■ Camera

Configurez les paramètres de caméra.

- ① Touchez **Camera**.
- ② Réglez chaque option et touchez **↩**.

Pour les explications détaillées, voir le Mode d'emploi.

##### ■ DEMO

Permet de paramétrer le mode de démonstration. Le choix par défaut est "ON".

- ① Touchez **DEMO** et réglez **ON** ou **OFF**.

#### 2 Touchez **Finish**.

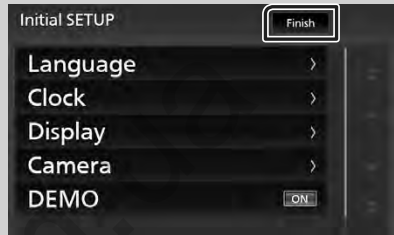

#### REMARQUE

- Ces réglages sont paramétrables depuis le menu de CONFIGURATION.

### Réglages du calendrier/horloge

#### 1 Appuyez sur le bouton **FNC**.

- L'écran FONCTION s'affiche.

#### 2 Touchez **⚙**.



- L'écran de menu de configuration s'affiche.

### 3 Touchez **User Interface**.



► L'écran d'interface utilisateur s'affiche.

### 4 Touchez **Clock Adjust**.

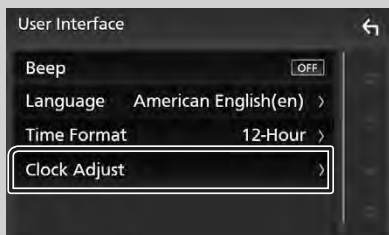

### 5 Réglez la date puis l'heure.

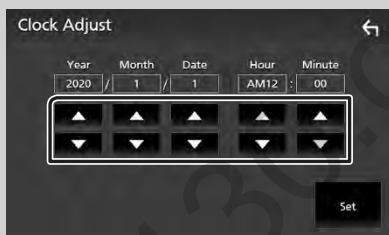

### 6 Touchez **Set**.

#### REMARQUE

- Désactivez **RDS CT** avant de régler l'horloge. Voir le Mode d'emploi.

## Régler le volume.

Pour régler le volume (0 à 40), Appuyez sur **+** pour augmenter, et appuyez sur **-** pour réduire.

Maintenez **+** enfoncé pour augmenter le volume de façon continue jusqu'au niveau 15.



## Fonctionnement tactile

Pour réaliser des opérations sur l'écran, vous devez toucher, toucher longuement, feuilleter ou défiler pour sélectionner un élément, afficher l'écran de menu de réglage, changer la page, etc.

#### ● Toucher

Touchez légèrement l'écran pour sélectionner un élément sur l'écran.

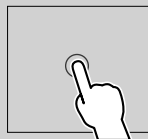

#### ● Toucher longuement

Touchez l'écran et gardez votre doigt sur l'écran jusqu'à ce que l'affichage change ou qu'un message soit affiché.

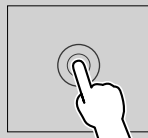

#### ● Feuilleter

Faites glisser votre doigt rapidement vers la gauche ou vers la droite sur l'écran pour changer de page.

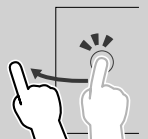

Vous pouvez faire défiler l'écran de la liste en le faisant défiler au doigt vers le haut ou vers le bas.





#### ● Défiler

Faites glisser votre doigt vers le haut ou le bas pour faire défiler l'écran.



### Commande tactile :

Vous pouvez aussi commander la lecture en déplaçant votre doigt sur le panneau tactile de la façon suivante (pour certaines sources, le contrôle gestuel n'est pas disponible).

- Glissement du doigt vers le haut/bas :
  - Fonctionne de la même manière qu'en appuyant sur  /  (Média) dans l'écran de commande USB.
  - Pour le tuner, les stations de diffusion préréglées du tuner sont commutées.
- Glissement du doigt vers la gauche/droit :
  - Fonctionne de la même façon que par pression sur  / .
- Bougez votre doigt dans le sens horaire ou antihoraire : augmente/diminue le volume.



### Descriptions de l'écran d'ACCUEIL

La plupart des fonctions sont accessibles depuis l'écran ACCUEIL.



- |          |  |
|----------|--|
| <b>1</b> | • Icônes de raccourci de source de lecture. (p.36)   |
| <b>2</b> | • Informations sur la source actuelle.<br>• Touchez pour afficher l'écran de contrôle de la source en cours. |
| <b>3</b> | • Widget (élément graphique)   |
| <b>4</b> | • Affiche l'écran de sélection de la source. (p.36)  |

- |          |   |
|----------|---|
| <b>5</b> | • Affiche l'écran de menu CONFIGURATION.  |
| <b>6</b> | • Affiche l'écran Mains libres. (p.44)<br>• Lorsque vous vous connectez avec Apple CarPlay ou Android Auto, le mode de fonctionnement est le même que sur un téléphone fourni dans Apple CarPlay ou Android Auto. |

### Affiche l'écran d'ACCUEIL

- 1** Appuyez sur le bouton .

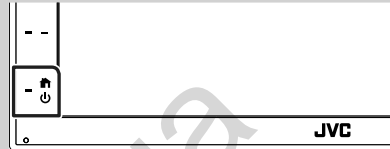

- L'écran d'ACCUEIL apparaît.

### Descriptions de l'écran de sélection de source

Vous pouvez afficher toutes les sources de lecture et les options sur l'écran de sélection de source.



- |          |   |
|----------|---|
| <b>1</b> | • Change la source de lecture.<br>Pour les sources de lecture, voir <b>Sélectionnez la source de lecture (p.36)</b> . |
| <b>2</b> | • Revient à l'écran précédent.  |
| <b>3</b> | • Affiche l'écran de menu CONFIGURATION.  |

## Sélectionnez la source de lecture

- 1 Touchez  sur l'écran d'ACCUEIL.  
Depuis cet écran, vous pouvez sélectionner les sources et fonctions suivantes.

	<ul style="list-style-type: none"> <li>• Bascule vers l'écran Apple CarPlay depuis l'iPhone connecté.</li> </ul>
	<ul style="list-style-type: none"> <li>• Passe à l'écran Android Auto depuis le smartphone Android connecté. Il est nécessaire de connecter un smartphone Android compatible avec Android Auto et de définir <b>Mode sur Android Auto</b>.</li> </ul>
	<ul style="list-style-type: none"> <li>• Passe à l'écran de miroitage USB depuis le smartphone Android connecté. Il est nécessaire de connecter un smartphone Android avec l'application « Mirroring OA for JVC » installée et de définir <b>Mode sur Mirroring for Android™</b>.</li> </ul>
	<ul style="list-style-type: none"> <li>• Affiche l'écran Mains libres. <b>(p.44)</b> Lorsque ni Apple CarPlay, ni Android Auto, ni un téléphone mains libres Bluetooth n'est connecté, le message « <b>Disconnected</b> » s'affiche. sur l'écran TEL. Lorsque vous vous connectez avec Apple CarPlay ou Android Auto, le mode de fonctionnement est le même que sur un téléphone fourni dans Apple CarPlay ou Android Auto.</li> </ul>
	<ul style="list-style-type: none"> <li>• Commute sur la réception radio. <b>(p.40)</b></li> </ul>
	<ul style="list-style-type: none"> <li>• Active un lecteur audio Bluetooth.</li> </ul>
	<ul style="list-style-type: none"> <li>• Joue les fichiers d'un périphérique USB. <b>(p.39)</b></li> </ul>
	<ul style="list-style-type: none"> <li>• Commute sur un appareil extérieur connecté à la borne d'entrée AV-IN.</li> </ul>
	<ul style="list-style-type: none"> <li>• Commute sur la réception radio satellite SiriusXM®. <b>(p.41)</b></li> </ul>
	<ul style="list-style-type: none"> <li>• Met hors service la source AV. <b>(p.36)</b></li> </ul>

## Pour éteindre la source AV

- 1 Touchez  sur l'écran d'ACCUEIL.
- 2 Touchez **AV Off**.



## Descriptions de l'écran de commande de source

Certaines fonctions sont accessibles depuis la plupart des écrans.

Indicateurs



Menu secondaire



### 1 TEL / [Phone Icon]

Informations concernant les périphériques Bluetooth connectés.

### 2 [Source Icon] Icône de toutes les sources

Affiche toutes les sources.

### 3 Écran secondaire

- [Left/Right Arrow]: L'écran secondaire change à chaque fois que vous le touchez. Vous pouvez aussi changer l'écran secondaire en faisant défiler vers la gauche ou la droite sur l'écran.
- Indicateurs : Affiche l'état actuel de la source et ainsi de suite.
  - **MUTE** : La fonction de réglage de coupure de son (sourdine) est active.
  - **LOUD** : La fonction de réglage du volume est active.
- Menu secondaire
  - **DIM** : Opération lorsque l'icône est touchée : La première touche assombrit l'écran, la deuxième touche assombrit davantage l'écran et la troisième touche restaure la luminosité d'origine de l'écran.
  - [Equalizer Icon] : Affiche l'écran de l'égaliseur graphique. **(p.48)**
  - [Phone Icon] : Affiche l'écran APP (Apple CarPlay/Android Auto).

### 4 [Phone Icon]

Touchez pour afficher l'écran mains-libres.

**(p.44)**

Lorsque vous vous connectez avec Apple CarPlay ou Android Auto, le mode de fonctionnement est le même que sur un téléphone fourni dans Apple CarPlay ou Android Auto.

## Écran FONCTION

- 1 Appuyez sur le bouton **FNC**.



➤ L'écran FONCTION s'affiche.

- 2 Touchez pour afficher l'écran FONCTION.



Le menu contient les options suivantes.

	• Affiche l'écran de menu CONFIGURATION.
	• Affiche l'écran APP (Apple CarPlay/Android Auto).
	• Affiche l'écran de réglage de l'écran.
	• Affiche la caméra de vue.
	• Affiche l'écran de sélection de la source. <b>(p.36)</b>
	• Éteint l'affichage. <b>(p.38)</b>
	• Affiche l'écran audio. <b>(p.47)</b>
	• Fermez l'écran FONCTION.

## Mettez l'écran hors tension

- 1 Sélectionnez sur l'écran FONCTION.



- Pour allumer l'écran

- 1 Touchez l'affichage.

## Écran des listes

Certaines touches de fonction sont communes aux écrans de liste de la plupart des sources.



- 1

Affiche la fenêtre de sélection de type liste.

- 2

Affiche la liste des fichiers de musique ou de film.

- 3 **Défilement du texte**

Fait défiler le texte affiché.

- 4 **etc.**

Les touches ayant plusieurs fonctions s'affichent ici.

- : Lit toutes les pistes du dossier contenant la piste en cours.
- : Remonte au niveau hiérarchique supérieur.

- 5 / / / **Défilement de la page**

Vous pouvez changer de page pour afficher plus d'éléments en appuyant sur / .

- / : Affiche la page du haut ou la page du bas.

- 6 **Retour**

Revient à l'écran précédent.

### REMARQUE



- Les boutons qui ne peuvent pas être activés depuis la liste ne sont pas affichés.

# USB

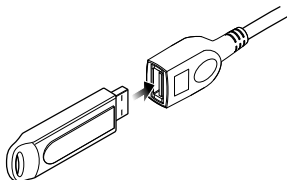

## Connecter un périphérique USB

- 1 Branchez le périphérique USB avec le câble USB. (p.52)



- 2 Appuyez sur le bouton .
- 3 Touchez .
- 4 Touchez **USB**. (p.36)

### Déconnectez le périphérique USB

- 1 Appuyez sur le bouton .
- 2 Touchez .
- 3 Sélectionnez une source autre que **USB**.
- 4 Débranchez le périphérique USB.

### Périphérique USB utilisable

Vous pouvez utiliser sur cet appareil une clé USB de mémoire de masse.





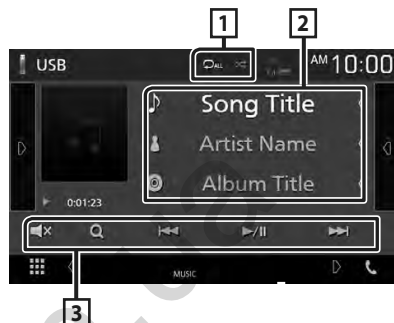

Le terme « USB device » indique dans ce manuel un dispositif mémoire flash.

## Utilisation de base USB

La plupart des fonctions sont utilisables depuis l'écran de contrôle de la source et depuis l'écran de lecture.

### Écran de contrôle







-  : Répète la piste/le dossier en cours. Chaque fois que vous touchez la touche, le mode de répétition change dans l'ordre suivant ; Répétition de fichier (), Répétition de dossier (), Répétition de tous ()
-  : Lit de manière aléatoire tous les morceaux du dossier en cours. Chaque fois que vous touchez la touche, le mode aléatoire change dans l'ordre suivant ; Fichier aléatoire (), Fonction aléatoire sur arrêt ()

### **2** Informations sur la piste

Affiche les informations concernant le fichier en cours.

### **3** Touches d'opération

-  : Fait une recherche de piste/fichier. Pour plus de détails sur les opérations de recherche, voir le Mode d'emploi.
-  : Recherche la piste/fichier précédent/suivant. Touchez et maintenez enfoncé pour effectuer une avance ou un retour rapide.
-  : Lance la lecture ou met en pause.
-  : Touchez pour désactiver le son ou l'activer.



# Tuner

## Utilisation de base de la radio

La plupart des fonctions sont utilisables depuis l'écran de contrôle des sources.

Pour passer sur la source Tuner, touchez l'icône **Tuner** sur l'écran de sélection de la source. (p.36)

### Écran de contrôle



### Ouvrir le tiroir



### 1 Affichage des informations

Affiche les informations concernant la station en cours : Fréquence

Toucher vous permet de basculer entre le Contenu A et le Contenu B.

- Contenu A : Nom du PS, texte radio, genre PTY
- Contenu B : Texte radio plus, titre de l'artiste

**Preset#** : Numéro de présélection

### 2 Mode de recherche

Sélectionne successivement les modes d'exploration des fréquences, dans l'ordre suivant : **AUTO1**, **AUTO2**, **MANUAL**.

- **AUTO1** : Syntonise automatiquement sur une station offrant une bonne réception.
- **AUTO2** : Syntonise les stations en mémoire les unes après les autres.
- **MANUAL** : Commute sur la fréquence suivante manuellement.

### 3 Touches d'opération

- : Syntoniser sur une station. Il est possible de changer de méthode de sélection des fréquences (voir 2 dans le tableau).
- : Touchez pour désactiver le son ou l'activer.

### 4 Liste des présélections

- Touchez le côté droit de l'écran pour afficher la Liste de présélection. Appuyez de nouveau pour fermer la liste.
- Rappelle la station mémorisée.
- En le touchant pendant 2 secondes, il mémorise la station en cours de réception.

### 5 Panneau de fonction

Appuyez sur le côté gauche de l'écran pour afficher le panneau de fonction. Appuyez de nouveau pour fermer le panneau.

- **TI** (FM uniquement) : Active le mode infotrafic. Pour plus de détails, voir le Mode d'emploi.
- **SETUP** : Affiche l'écran de CONFIGURATION du syntoniseur. Pour plus de détails, voir le Mode d'emploi.
- **AME** : Prédéfini automatiquement les stations. Pour plus de détails, voir le Mode d'emploi.
- **PTY** (FM uniquement) : Recherche un programme en spécifiant un type de programme. Pour plus de détails, voir le Mode d'emploi.
- **MONO** (FM uniquement) : Sélectionne la réception en mono.

### 6 FM AM

Change la bande.

### 7 Éléments indicateurs

- **ST** : Indique que l'émission stéréo est actuellement reçue.
- **MONO** : Indique que la fonction monophonique forcée est active.
- **TI** : Indique l'état de réception des informations routières.
  - Blanc : Le signal TP est reçu.
  - Orange : Le signal TP n'est pas reçu.

## Utilisation de la mémorisation

### ■ Mémoire automatique

Vous pouvez mémoriser automatiquement les stations offrant une bonne réception.

#### 1 Touchez la touche de la bande de votre choix.



#### 2 Touchez **■** sur le côté gauche de l'écran. Touchez **AME**.

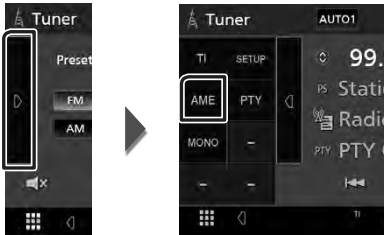

► Un écran de confirmation s'affiche.

#### 3 Touchez **Yes**.

► La mémorisation automatique se lance.

### ■ Mémoire manuelle

Vous pouvez mémoriser la station que vous êtes en train de recevoir.

#### 1 Sélectionnez la station que vous souhaitez mémoriser.

#### 2 Touchez **FM#** (#:1-24) ou **AM#** (#:1-12) dans lequel vous souhaitez enregistrer la station pendant 2 secondes.

## SiriusXM®

### Utilisation de base de SiriusXM®

Seul SiriusXM® vous propose encore plus de ce que vous aimez écouter, tout au même endroit. Disposez de plus de 140 canaux, musique sans publicité comprise plus le meilleur du sport, des informations, des débats, de la comédie et du divertissement. Bienvenue dans le monde de la radio satellite. Syntoniseur pour véhicule SiriusXM et abonnement requis. Pour de plus amples informations, visitez la page [www.siriusxm.com](http://www.siriusxm.com).

Pour écouter la source SiriusXM, appuyez sur l'icône **SiriusXM** de l'écran de sélection de la source. (p.36)

#### Activation de l'abonnement

- Vérifiez votre identifiant radio.  
L'identifiant de la radio satellite SiriusXM est nécessaire pour l'activation et est disponible en allant sur le Canal 0 ainsi que sur l'étiquette qui se trouve sur le syntoniseur SiriusXM Connect et son emballage.  
L'identifiant Radio ne comprend pas les lettres I, O, S ou F.
- Activez le syntoniseur de véhicule SiriusXM, à l'aide d'une des deux méthodes expliquées ci-après :
  - Pour les utilisateurs résidant aux États-Unis  
En ligne : Visitez [www.siriusxm.com/activatenow](http://www.siriusxm.com/activatenow)  
Téléphone : Appelez le service après-vente SiriusXM au 1-866-635-2349
  - Pour les utilisateurs résidant au Canada :  
En ligne : Visitez <https://www.siriusxm.ca/help/activation-help/>  
Téléphone : Appelez le service après-vente XM au 1-877-438-9677

#### REMARQUE

- L'accessoire en option est indispensable au fonctionnement du Radio satellite SiriusXM®.

### Écran de contrôle



### Ouvrir le tiroir



#### 1 Affichage des informations

- Affiche les informations du canal en cours :  
Nom du canal  
P# : Numéro de préréglage  
#CH : Numéro de canal  
Toucher vous permet de basculer entre le Contenu A et le Contenu B.
  - Contenu A : Nom de l'artiste, titre de la chanson
  - Contenu B : Informations du contenu, nom de la catégorie

#### REMARQUE

- Pendant l'obtention du contenu, « Waiting » apparaît sur l'affichage.

#### 2 Bouton de bande

Bascule entre les bandes. (SXM1/SXM2/SXM3)

#### 3 Panneau d'illustration/de fonction

- Affiche les illustrations des albums pour la plupart des chaînes musicales SiriusXM.
- Appuyez sur de l'écran pour afficher le panneau de fonction. Appuyez sur pour fermer le panneau.
  - **Direct Channel** : Touchez et entrez le numéro de votre choix. Pour plus de détails, voir le Mode d'emploi.
  - **SETUP** : Touchez pour afficher l'écran CONFIGURATION SiriusXM. Pour plus de détails, voir le Mode d'emploi.
  - **Replay/Live** : Touchez pour activer ou désactiver le mode replay. Voir le Mode d'emploi.

#### 4 Touches d'opération

- : Affichez l'écran de recherche de catégorie. Pour plus de détails sur les opérations de recherche, voir le Mode d'emploi.
- : Lance la lecture ou met en pause. Voir le Mode d'emploi.
- : Sélectionne un canal.
- : Touchez pour désactiver le son ou l'activer.

#### 5 Liste des présélections

- Appuyez sur de l'écran pour afficher la liste de préréglages. Appuyez sur pour fermer la liste.
- Rappelle le canal mémorisé.
- Touchez pendant 2 secondes pour mémoriser le canal en cours de réception.

# Utilisation du Bluetooth

## À propos du téléphone mobile et du lecteur audio Bluetooth

Cet appareil est conforme aux caractéristiques techniques suivantes de la norme Bluetooth :

Version

Bluetooth Ver. 4.1

Profil

Téléphone mobile :

HFP (Profil mains libres)

SPP (Profil port série)

PBAP (Profil d'accès au répertoire téléphonique)

Lecteur audio :

A2DP (Profil de distribution audio avancée)

AVRCP (Profil de télécommande audio/vidéo)

Codec son

SBC, AAC

### REMARQUE

- Les appareils disposant de la fonction Bluetooth sont certifiés conformes à la norme Bluetooth d'après la procédure prescrite par Bluetooth SIG.
- Cependant, il est possible que ces appareils ne puissent pas communiquer avec certains types de téléphones portables.

## Enregistrez depuis le périphérique Bluetooth

Il est indispensable de déclarer à l'appareil le lecteur audio ou le téléphone mobile Bluetooth avant de pouvoir utiliser la fonction Bluetooth.

- 1 Activer la fonction Bluetooth sur votre smartphone/téléphone portable.**
- 2 Recherchez l'appareil (« KW-M\*\*\*\*\* ») à partir de votre smartphone/téléphone portable.**
- 3 Utilisez votre smartphone/téléphone portable en fonction des messages affichés.**
  - **Confirmez la requête sur le smartphone/téléphone portable.**



- Si un code PIN est requis, entrez le code PIN (« 0000 »).

- 4 Appuyez sur le bouton FNC.**
  - L'écran FONCTION s'affiche.

- 5 Touchez .**



- L'écran de menu de configuration s'affiche.

6 Touchez **Bluetooth**.



➤ L'écran de configuration Bluetooth s'affiche.

7 Touchez **Select Device** sur l'écran de CONFIGURATION du Bluetooth.



8 Touchez **[<>]** que vous souhaitez vous connecter.



**REMARQUE**

• Si le pictogramme est en surbrillance, cela indique que l'appareil correspondant sera utilisé.

**Pour supprimer le périphérique Bluetooth enregistré**

1 Touchez **Delete**.



➤ Le message de confirmation s'affiche.

2 Touchez **Yes**.

**Utilisation du module mains-libres**

Vous pouvez utiliser la fonction téléphone de l'appareil en lui connectant un téléphone Bluetooth.

**REMARQUE**

• Lorsque l'application Apple CarPlay ou Android Auto est connectée, la fonction Bluetooth mains libres ne peut pas être utilisée. Seule la fonction mains-libres d'Apple CarPlay ou d'Android Auto peut être utilisée.

**Effectuez un appel**

1 Touchez **Phone**.



➤ L'écran mains-libres s'affiche.

2 Sélectionnez une méthode de numérotation.



- : Appel depuis l'historique des appels
- : Appel depuis le répertoire téléphonique
- : Appel depuis un numéro présélectionné
- : Appel en saisissant un numéro de téléphone
- : Reconnaissance vocale
- : CONFIGURATION Bluetooth

## ● Configuration Bluetooth

1) Touchez .

L'écran de configuration Bluetooth s'affiche.

### REMARQUE

- Les pictogrammes d'état affichés, notamment ceux représentant une batterie et une antenne, peuvent être différents de ceux affichés sur le téléphone portable.
- Le fait de configurer le téléphone portable au mode privé peut désactiver la fonction mains libres.

## Appel depuis l'historique des appels

1 Touchez .

2 Sélectionnez dans la liste le numéro de téléphone.



## Appel par entrée d'un numéro de téléphone

1 Touchez .

2 Utilisez les touches numériques pour entrer un numéro de téléphone.

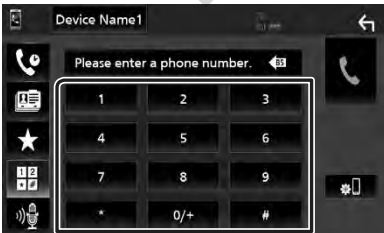

3 Touchez .

## Appel depuis un numéro présélectionné

1 Touchez .

2 Touchez le nom ou le numéro de téléphone.



## Appel depuis le répertoire téléphonique

1 Touchez .

2 Sélectionnez la personne que vous souhaitez appeler dans la liste.

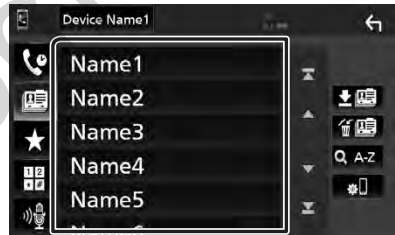

3 Sélectionnez dans la liste le numéro de téléphone.

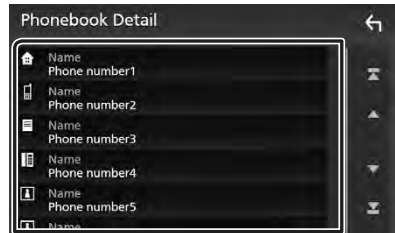

### REMARQUE

- Si aucun répertoire n'a été téléchargé, toucher **Download Phonebook Now** va commencer le téléchargement du répertoire.

## ■ Réception d'un appel

- 1 Touchez  pour répondre à un appel téléphonique ou  pour rejeter un appel entrant.



### REMARQUE

- Lorsque l'affichage est déjà occupé par la caméra de vision, cet écran ne s'affiche pas même si un appel est reçu. Pour afficher cet écran, ramenez le sélecteur de vitesse du véhicule sur la position du conducteur.

### Pour mettre fin à l'appel

- 1 Pendant une conversation, touchez .

## ■ Actions possibles pendant un appel



### ● Régler le volume de réception

Appuyez sur le bouton  ou .



### ● Envoyer la tonalité de numérotation

Touchez **DTMF** pour afficher l'écran de saisie des tonalités.

Vous pouvez envoyer des tonalités en touchant les touches voulues à l'écran.

### ● Sélection de la sortie vocale

En touchant  / , la sortie vocale bascule systématiquement entre le téléphone portable et le haut-parleur.

### ● Attente d'appel

Lorsque vous recevez un appel alors que vous êtes en cours de conversation, vous pouvez répondre à l'appel entrant en touchant . L'appel en cours est alors mis en attente.

À chaque appui sur , vous changez de correspondant.

Touchez  pour mettre fin à l'appel en cours et passer sur l'appel en attente.

# Contrôle de l'audio

Vous pouvez agir sur les différents paramètres, comme la balance audio ou le niveau du caisson de graves par exemple.

- 1 Appuyez sur le bouton **FNC**.  
 ➤ L'écran FONCTION s'affiche.

- 2 Touchez .



## Contrôle de l'audio en général

- 1 Appuyez sur le bouton **FNC**.  
 ➤ L'écran FONCTION s'affiche.

- 2 Touchez .

- 3 Touchez **Fader / Balance**.

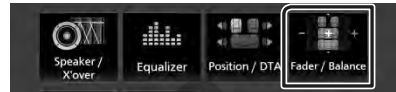

- 4 Réglez chaque option comme suit.

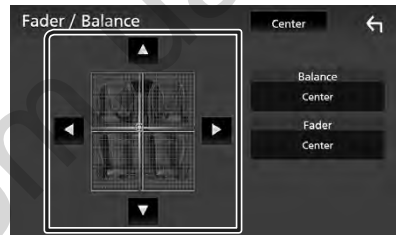

### Fader / Balance

Réglez la balance en agissant sur les touches périphériques.

◀ et ▶ permettent de régler la balance droite/gauche.

▲ et ▼ permettent de régler la balance avant/arrière.

### Center

Annulez le réglage.



### ■ Contrôle d'égaliseur

Vous pouvez régler l'égaliseur en sélectionnant le réglage optimal pour chaque catégorie.

#### 1 Appuyez sur le bouton **FNC**.

➤ L'écran FONCTION s'affiche.

#### 2 Touchez .

➤ L'écran audio s'affiche.

#### 3 Touchez **Equalizer**.

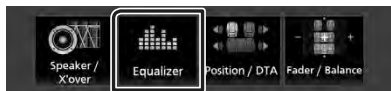

#### 4 Touchez l'écran pour configurer l'égaliseur graphique comme vous le souhaitez.

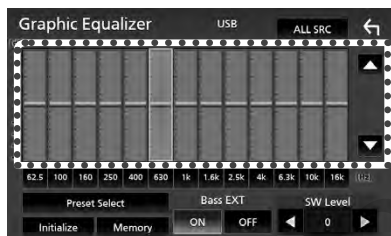

#### ■ ALL SRC

Appliquer l'égaliseur réglé pour toutes les sources. Touchez **ALL SRC** puis touchez **OK** sur l'écran de confirmation.

#### ■ Niveau de gain (zone de cadre pointillé)

Réglez le niveau de gain en touchant chacune des barres de fréquences.

Vous pouvez sélectionner la barre de fréquence et ajuster son niveau en utilisant ▲, ▼.

#### ■ Preset Select

Affiche l'écran pour présenter à nouveau la courbe prédéfinie de l'égaliseur.

#### ■ Initialize

La courbe EQ actuelle est revenue en position linéaire.

#### ■ Memory

Enregistre la courbe d'égaliseur ajustée de « User1 » à « User3 ».

#### ■ Bass EXT (Paramètres étendus des graves)

Lorsque cette fonction est active, toute fréquence inférieure à 62,5 Hz est configurée sur le même niveau de gain que la fréquence 62,5 Hz.

#### ■ SW Level

Règle le volume du caisson de graves.

# Connexion/Installation

## Avant l'installation

Avant d'installer cet appareil, veuillez prendre les mesures de précaution suivantes.

### ▲ AVERTISSEMENTS

- Si vous branchez le câble d'allumage (rouge) et le câble de la batterie (jaune) au châssis de la voiture (masse), il peut y avoir un court-circuit entraînant, à son tour, un incendie. Il faut toujours brancher ces câbles à la source d'alimentation fonctionnant via le boîtier de fusibles.
- Ne débranchez pas le fusible du câble d'allumage (rouge) ni du câble de la batterie (jaune). L'alimentation électrique doit être connectée aux câbles via le fusible.

### ▲ ATTENTION

- Installez cet appareil dans la console du véhicule. Ne touchez pas les éléments métalliques de cet appareil pendant et juste après l'utilisation de l'appareil. Les éléments métalliques tels que le dissipateur thermique et le coffret sont très chauds.

### REMARQUE

- Le montage et le câblage de ce produit requièrent expérience et savoir-faire. Pour des questions de sécurité, les travaux de montage et de câblage doivent être effectués par des professionnels.
- Veillez à brancher l'appareil à une alimentation électrique négative de 12 Vcc avec mise à la terre.
- N'installez pas l'appareil dans un endroit directement exposé aux rayons du soleil, à une chaleur excessive ou à l'humidité. Évitez également les endroits trop poussiéreux ou susceptibles d'être éclaboussés par de l'eau.
- N'utilisez pas vos propres vis. N'utilisez que les vis fournies. L'utilisation de vis non appropriées risque d'endommager l'appareil.
- Si l'appareil n'est pas sous tension (« There is an error in the speaker wiring. Please check the connections. » (Il y a un problème avec le câblage du haut-parleur. Veuillez vérifier les branchements) s'affiche), le câble du haut-parleur est peut-être en court-circuit ou est en contact avec le châssis du véhicule et la fonction de protection a peut-être été enclenchée. C'est pourquoi il faut vérifier le câble de l'enceinte.
- Si l'allumage de votre véhicule ne possède pas de position ACC, branchez les câbles d'allumage





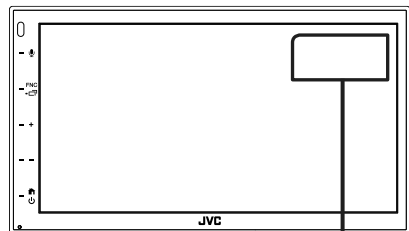

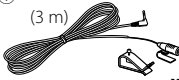

à une source d'alimentation que la clé de contact peut allumer ou éteindre. Si vous branchez le câble d'allumage à une source d'alimentation à tension constante comme les câbles de la batterie, il se peut que la batterie se décharge.

- Si la console est dotée d'un couvercle, veillez à installer l'appareil de sorte que la façade ne heurte pas le couvercle quand elle s'ouvre ou se ferme.
- Si le fusible saute, vérifiez d'abord que les câbles ne se touchent pas afin d'éviter tout court-circuit, puis remplacez l'ancien fusible par un nouveau fusible de même puissance.
- Isolez les câbles non connectés avec un ruban vinyl, ou tout autre matériau similaire. Pour éviter tout court-circuit, ne retirez pas les capuchons placés aux extrémités des câbles non connectés ou des bornes.
- Branchez correctement les câbles de l'enceinte aux bornes correspondantes. L'appareil peut subir des dommages ou ne plus fonctionner si vous partagez les fils ⊖ ou les mettez à la masse avec une partie métallique du véhicule.
- Si seulement deux enceintes sont branchées au système, branchez les connecteurs soit aux bornes de sortie avant soit aux bornes de sortie arrière (ne pas mélanger les bornes de sortie avant et arrière). Par exemple, si vous connectez le connecteur ⊕ de l'enceinte gauche à une borne de sortie avant, ne connectez pas le connecteur ⊖ à une borne de sortie arrière.
- Une fois l'appareil installé, vérifiez que les feux de freinage, les clignotants et les essuie-glace, etc. du véhicule fonctionnent correctement.
- N'exercez pas de pression excessive sur la surface du panneau lors de l'installation de l'appareil dans le véhicule. Cela risque de rayer la surface, de l'endommager ou d'entraîner une défaillance.
- Il se peut que la réception soit mauvaise si des objets métalliques se trouvent à proximité de l'antenne Bluetooth.

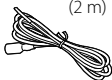

Antenne Bluetooth

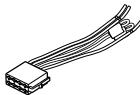
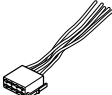
## Accessoires fournis pour l'installation

① (3 m)  x1	②  x1
③ (2 m)  x1	④  x1
⑤  (M5 × 6 mm) x6	⑥  (M5 × 8 mm) x6
⑦  x1	⑧  x1
⑨  x2	

## Procédure d'installation

- 1) Pour éviter les courts-circuits, retirez la clé de contact de l'allumage puis débranchez la borne  $\ominus$  de la batterie.
- 2) Veillez à effectuer correctement les connexions des câbles d'entrée et de sortie pour chaque appareil.
- 3) Branchez le câble sur le faisceau de fils.
- 4) Prenez le connecteur B (accessoire ⑧) sur le faisceau de fils, puis branchez-le au connecteur de l'enceinte dans votre véhicule.
- 5) Prenez le connecteur A (accessoire ⑦) sur le faisceau de fils, puis branchez-le à la prise d'alimentation externe de votre véhicule.
- 6) Branchez le connecteur du faisceau de fils sur l'appareil.
- 7) Installez l'appareil dans votre véhicule.
- 8) Reconnectez la borne  $\ominus$  de la batterie.
- 9) Appuyez sur le bouton réinitialiser.

## Installation de l'appareil

### Voitures non japonaises

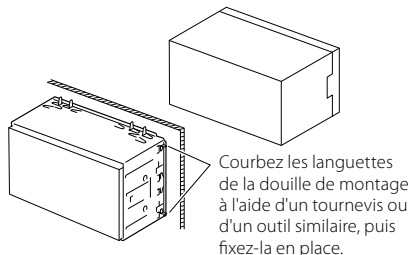

### REMARQUE

- Vérifiez que l'appareil est correctement en place. Si l'appareil n'est pas stable, cela peut occasionner un dysfonctionnement (le son peut par exemple sauter).

### Voitures japonaises

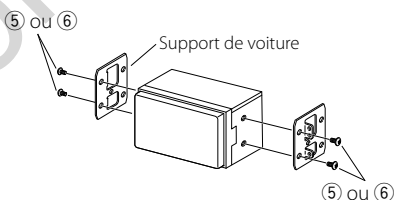

### Plaqué de garniture

- 1) Fixez l'accessoire ② sur l'appareil.

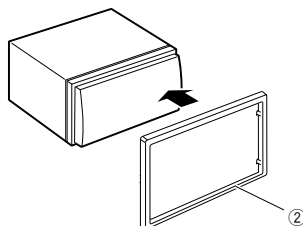

## Microphone

- 1) Vérifiez la position d'installation du microphone (accessoire ①).
- 2) Nettoyez la surface d'installation.
- 3) Retirez le séparateur du microphone (accessoire ①) et collez le microphone à l'emplacement indiqué ci-dessous.
- 4) Branchez le câble du microphone sur l'appareil en le fixant à divers endroits à l'aide de ruban adhésif ou de toute autre méthode appropriée.
- 5) Réglez l'orientation du microphone (accessoire ①) en direction du conducteur.

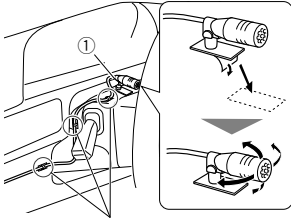

Fixez un câble avec du ruban spécialement prévu à cet effet.

### REMARQUE

- Échanger les attaches si nécessaire.

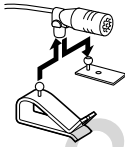

## Retrait de la plaque de garniture

- 1) Utilisez la clé d'extraction (accessoire ④) pour sortir les quatre languettes (deux sur la partie gauche, deux sur la partie droite) en effectuant un mouvement de levier.

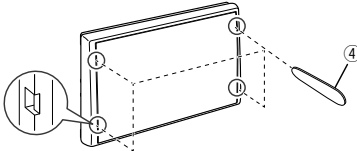

- 2) Tirez la plaque de garniture vers l'avant.

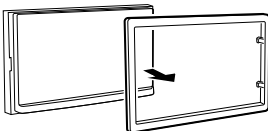

## Retrait de l'appareil

- 1) Retirez la plaque de garniture en vous référant à l'étape 1 de « **Retrait de la plaque de garniture** ».
- 2) Insérez la clé d'extraction (accessoire ⑨) profondément dans l'emplacement, comme illustré. (La saillie à la pointe de la clé d'extraction doit faire face à l'appareil.)

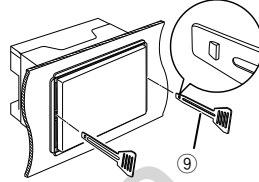

- 3) Une fois que vous avez correctement inséré la clé d'extraction, insérez l'autre clé d'extraction dans l'emplacement.

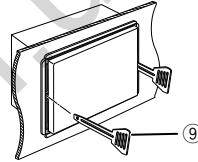

- 4) Extraire l'appareil à moitié.

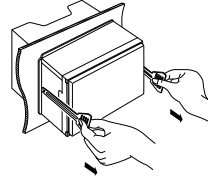

### REMARQUE

- Veillez à ne pas vous blesser avec les broches d'arrêt sur la clé d'extraction.

- 5) Tenez l'appareil des deux mains et faites-le sortir complètement en veillant à ne pas le laisser tomber.

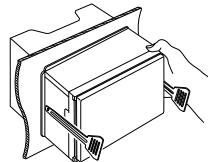

## ■ Connexion des câbles sur les contacts électriques

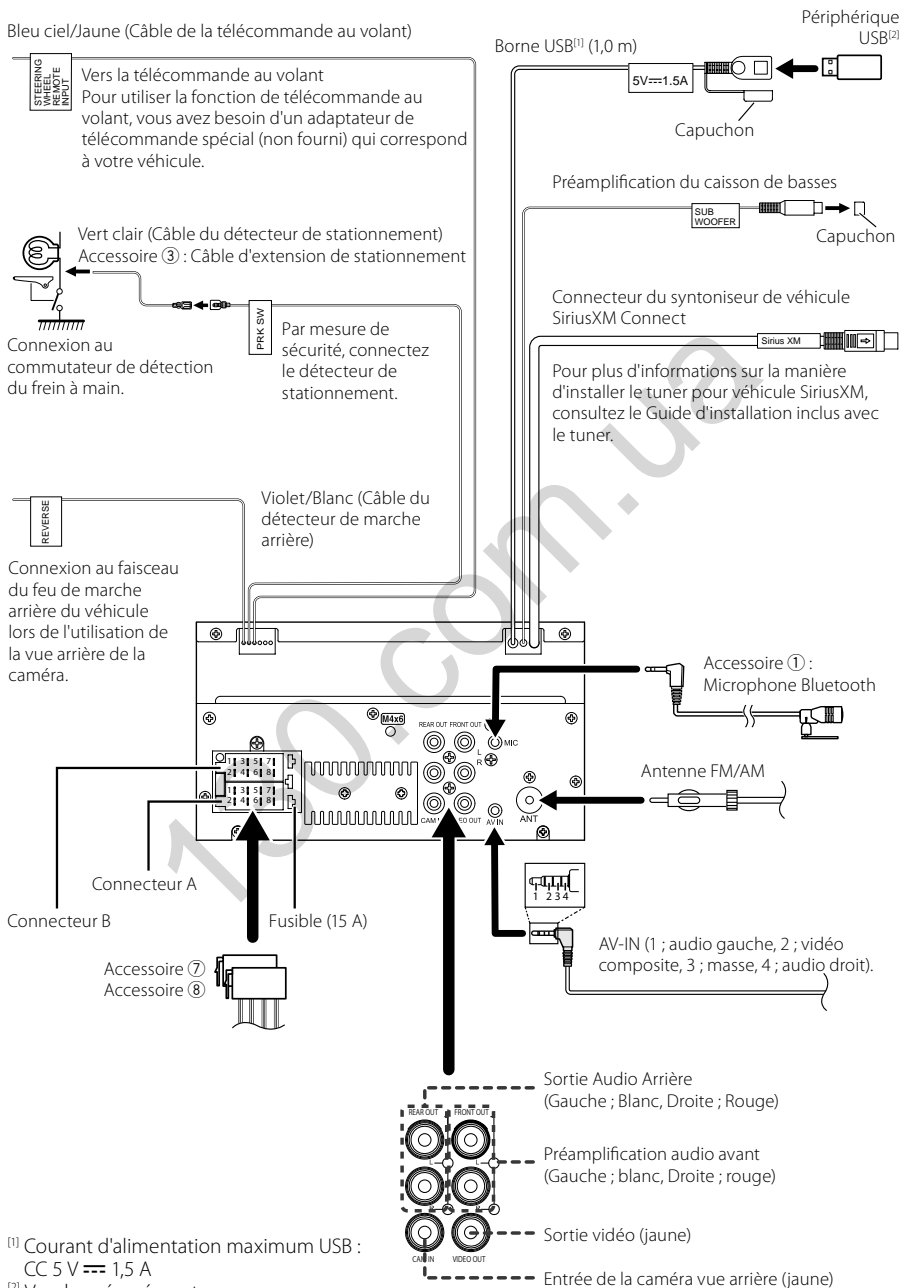

<sup>(1)</sup> Courant d'alimentation maximum USB : CC 5 V --- 1,5 A

<sup>(2)</sup> Vendue séparément

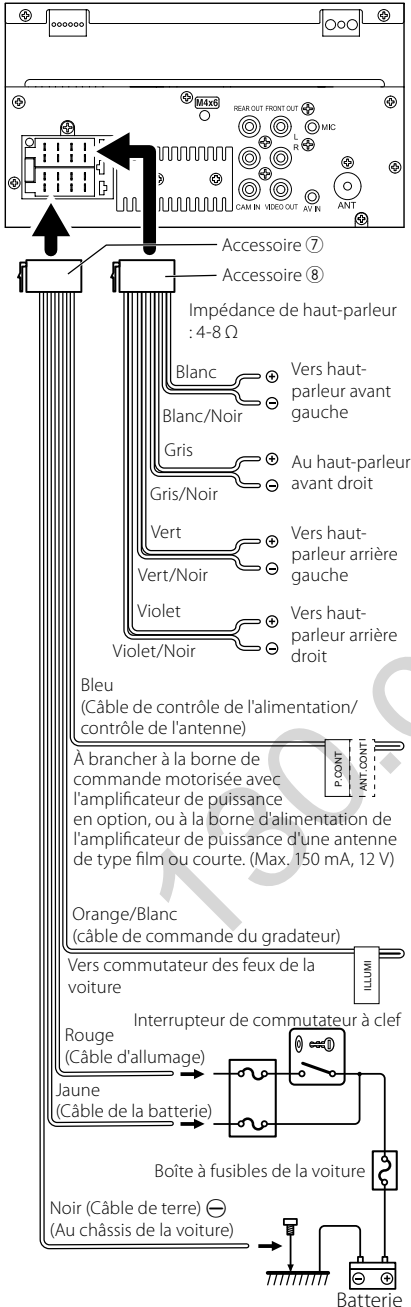

## Connecter un iPhone/Android

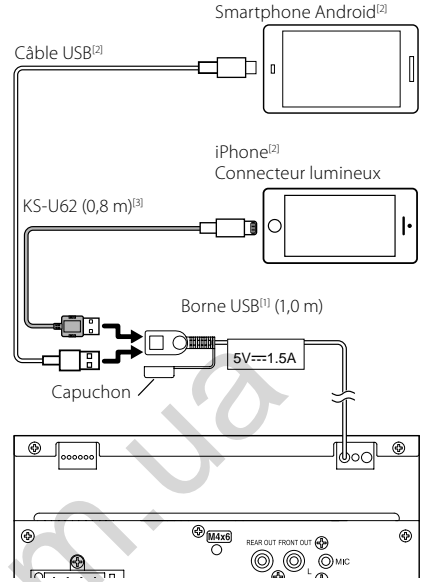

<sup>[1]</sup> Tension d'alimentation maximum pour iPhone : 5 V CC --- 1,5 A

<sup>[2]</sup> Vendue séparément

<sup>[3]</sup> Accessoire proposé en option

# Annexes

## Spécifications

### ■ Section Bluetooth

Fréquence

: 2,402 – 2,480 GHz

Puissance de sortie RF (E.I.R.P.)

: +8 dBm (moy.), Classe de puissance 1

### ■ Général

Tension de fonctionnement

: batterie de voiture 12 V CC

Impédance d'enceinte

: 4 – 8 Ω

**Les spécifications sont sujettes à changements sans notification.**

## À propos de cet appareil

### ■ Copyrights

- La marque du mot et les logos Bluetooth® sont des marques déposées de Bluetooth SIG, Inc. et toute utilisation de ces marques par JVC/KENWOOD Corporation est faite sous licence. Les autres marques déposées et appellations commerciales appartiennent à leurs propriétaires respectifs.
- Windows Media is a registered trademark or trademark of Microsoft Corporation in the United States and/or other countries.
- This product is protected by certain intellectual property rights of Microsoft. Use or distribution of such technology outside of this product is prohibited without a license from Microsoft.
- Use of the Made for Apple badge means that an accessory has been designed to connect specifically to the Apple product(s) identified in the badge, and has been certified by the developer to meet Apple performance standards. Apple is not responsible for the operation of this device or its compliance with safety and regulatory standards. Please note that the use of this accessory with an Apple product may affect wireless performance.
- Apple, iPhone and Lightning are trademarks of Apple Inc., registered in the U.S. and other countries.
- Apple, Siri, Apple CarPlay and Apple CarPlay logo are trademarks of Apple Inc., registered in the U.S. and other countries.
- App Store is a service mark of Apple Inc., registered in the U.S. and other countries.
- Sirius, XM and all related marks and logos are trademarks of Sirius XM Radio Inc. All rights reserved.
- IOS is a trademark or registered trademark of Cisco in the U.S. and other countries and is used under license.
- Google, Android, Google Play and Android Auto are trademarks of Google LLC.
- To use Android Auto on your car display, you'll need an Android Auto compatible vehicle or aftermarket stereo, an Android phone running Android 5.0 or higher, and the Android Auto app.
- Linux® is the registered trademark of Linus Torvalds in the U.S. and other countries.
- THIS PRODUCT IS LICENSED UNDER THE AVC PATENT PORTFOLIO LICENSE FOR THE PERSONAL USE OF A CONSUMER OR OTHER USES IN WHICH IT DOES NOT RECEIVE REMUNERATION TO (i) ENCODE VIDEO IN COMPLIANCE WITH THE AVC STANDARD ("AVC VIDEO") AND/OR (ii) DECODE AVC VIDEO THAT WAS ENCODED BY A CONSUMER ENGAGED IN A PERSONAL ACTIVITY AND/OR WAS OBTAINED FROM A VIDEO PROVIDER LICENSED TO PROVIDE AVC VIDEO. NO LICENSE IS GRANTED OR SHALL BE IMPLIED FOR ANY OTHER USE. ADDITIONAL INFORMATION MAY BE OBTAINED FROM MPEG LA, L.L.C. SEE [HTTP://WWW.MPEGLA.COM](http://www.MPEGLA.COM)

- THIS PRODUCT IS LICENSED UNDER THE MPEG-4 VISUAL PATENT PORTFOLIO LICENSE FOR THE PERSONAL AND NON-COMMERCIAL USE OF A CONSUMER FOR (i) ENCODING VIDEO IN COMPLIANCE WITH THE MPEG-4 VISUAL STANDARD ("MPEG-4 VIDEO") AND/OR (ii) DECODING MPEG-4 VIDEO THAT WAS ENCODED BY A CONSUMER ENGAGED IN A PERSONAL AND NON-COMMERCIAL ACTIVITY AND/OR WAS OBTAINED FROM A VIDEO PROVIDER LICENSED BY MPEG LA TO PROVIDE MPEG-4 VIDEO. NO LICENSE IS GRANTED OR SHALL BE IMPLIED FOR ANY OTHER USE. ADDITIONAL INFORMATION INCLUDING THAT RELATING TO PROMOTIONAL, INTERNAL AND COMMERCIAL USES AND LICENSING MAY BE OBTAINED FROM MPEG LA, L.L.C. SEE [HTTP://WWW.MPEGLA.COM](http://www.mpegla.com).

- THIS PRODUCT IS LICENSED UNDER THE VC-1 PATENT PORTFOLIO LICENSE FOR THE PERSONAL AND NON-COMMERCIAL USE OF A CONSUMER TO (i) ENCODE VIDEO IN COMPLIANCE WITH THE VC-1 STANDARD ("VC-1 VIDEO") AND/OR (ii) DECODE VC-1 VIDEO THAT WAS ENCODED BY A CONSUMER ENGAGED IN A PERSONAL AND NON-COMMERCIAL ACTIVITY AND/OR WAS OBTAINED FROM A VIDEO PROVIDER LICENSED TO PROVIDE VC-1 VIDEO. NO LICENSE IS GRANTED OR SHALL BE IMPLIED FOR ANY OTHER USE. ADDITIONAL INFORMATION MAY BE OBTAINED FROM MPEG LA, L.L.C. SEE [HTTP://WWW.MPEGLA.COM](http://www.mpegla.com)

- libFLAC

Copyright (C) 2000,2001,2002,2003,2004,2005,2006,2007,2008,2009 Josh Coalson

Redistribution and use in source and binary forms, with or without modification, are permitted provided that the following conditions are met:

- Redistributions of source code must retain the above copyright notice, this list of conditions and the following disclaimer.
- Redistributions in binary form must reproduce the above copyright notice, this list of conditions and the following disclaimer in the documentation and/or other materials provided with the distribution.
- Neither the name of the Xiph.org Foundation nor the names of its contributors may be used to endorse or promote products derived from this software without specific prior written permission.

THIS SOFTWARE IS PROVIDED BY THE COPYRIGHT HOLDERS AND CONTRIBUTORS "AS IS" AND ANY EXPRESS OR IMPLIED WARRANTIES, INCLUDING, BUT NOT LIMITED TO, THE IMPLIED WARRANTIES OF MERCHANTABILITY AND FITNESS FOR A PARTICULAR PURPOSE ARE DISCLAIMED. IN NO EVENT SHALL THE FOUNDATION OR CONTRIBUTORS BE LIABLE FOR ANY DIRECT, INDIRECT, INCIDENTAL, SPECIAL, EXEMPLARY, OR CONSEQUENTIAL DAMAGES (INCLUDING, BUT NOT LIMITED TO, PROCUREMENT OF SUBSTITUTE GOODS OR SERVICES; LOSS OF USE, DATA, OR PROFITS; OR BUSINESS INTERRUPTION) HOWEVER CAUSED AND ON ANY THEORY OF LIABILITY, WHETHER IN CONTRACT, STRICT LIABILITY, OR TORT (INCLUDING NEGLIGENCE OR OTHERWISE) ARISING IN ANY WAY OUT OF THE USE OF THIS SOFTWARE, EVEN IF ADVISED OF THE POSSIBILITY OF SUCH DAMAGE.

- libvorbis

Copyright (c) 2002-2008 Xiph.org Foundation

Redistribution and use in source and binary forms, with or without modification, are permitted provided that the following conditions are met:

- Redistributions of source code must retain the above copyright notice, this list of conditions and the following disclaimer.
- Redistributions in binary form must reproduce the above copyright notice, this list of conditions and the following disclaimer in the documentation and/or other materials provided with the distribution.
- Neither the name of the Xiph.org Foundation nor the names of its contributors may be used to endorse or promote products derived from this software without specific prior written permission.

THIS SOFTWARE IS PROVIDED BY THE COPYRIGHT HOLDERS AND CONTRIBUTORS "AS IS" AND ANY EXPRESS OR IMPLIED WARRANTIES, INCLUDING, BUT NOT LIMITED TO, THE IMPLIED WARRANTIES OF MERCHANTABILITY AND FITNESS FOR A PARTICULAR PURPOSE ARE DISCLAIMED. IN NO EVENT SHALL THE FOUNDATION OR CONTRIBUTORS BE LIABLE FOR ANY DIRECT, INDIRECT, INCIDENTAL, SPECIAL, EXEMPLARY, OR CONSEQUENTIAL DAMAGES (INCLUDING, BUT NOT LIMITED TO, PROCUREMENT OF SUBSTITUTE GOODS OR SERVICES; LOSS OF USE, DATA, OR PROFITS; OR BUSINESS INTERRUPTION) HOWEVER CAUSED AND ON ANY THEORY OF LIABILITY, WHETHER IN CONTRACT, STRICT LIABILITY, OR TORT (INCLUDING NEGLIGENCE OR OTHERWISE) ARISING IN ANY WAY OUT OF THE USE OF THIS SOFTWARE, EVEN IF ADVISED OF THE POSSIBILITY OF SUCH DAMAGE.

- libogg

Copyright (c) 2002, Xiph.org Foundation Redistribution and use in source and binary forms, with or without modification, are permitted provided that the following conditions are met:

- Redistributions of source code must retain the above copyright notice, this list of conditions and the following disclaimer.
- Redistributions in binary form must reproduce the above copyright notice, this list of conditions and the following disclaimer in the documentation and/or other materials provided with the distribution.
- Neither the name of the Xiph.org Foundation nor the names of its contributors may be used to endorse or promote products derived from this software without specific prior written permission.

THIS SOFTWARE IS PROVIDED BY THE COPYRIGHT HOLDERS AND CONTRIBUTORS "AS IS" AND ANY EXPRESS OR IMPLIED WARRANTIES, INCLUDING, BUT NOT LIMITED TO, THE IMPLIED WARRANTIES OF MERCHANTABILITY AND FITNESS FOR A PARTICULAR PURPOSE ARE DISCLAIMED. IN NO EVENT SHALL THE FOUNDATION OR CONTRIBUTORS BE LIABLE FOR ANY DIRECT, INDIRECT, INCIDENTAL, SPECIAL, EXEMPLARY, OR CONSEQUENTIAL DAMAGES (INCLUDING, BUT NOT LIMITED TO, PROCUREMENT OF SUBSTITUTE GOODS OR SERVICES; LOSS OF USE, DATA, OR PROFITS; OR BUSINESS INTERRUPTION) HOWEVER CAUSED AND ON ANY THEORY OF LIABILITY, WHETHER IN CONTRACT, STRICT LIABILITY, OR TORT (INCLUDING NEGLIGENCE OR OTHERWISE) ARISING IN ANY WAY OUT OF THE USE OF THIS SOFTWARE, EVEN IF ADVISED OF THE POSSIBILITY OF SUCH DAMAGE.



## Contenido

Antes de la utilización.....	56
Acerca de la Guía de inicio rápido.....	56
Cómo leer este manual.....	56
Precauciones.....	57
<b>Funciones básicas.....</b>	<b>58</b>
Funciones de los botones del panel frontal.....	58
Poner en marcha la unidad.....	58
Inicio.....	59
Ajuste del volumen.....	60
Operaciones de la pantalla táctil.....	60
Descripciones de la pantalla INICIO.....	61
Descripciones de la pantalla de selección de fuente..	61
Descripciones de la pantalla de control de fuente.....	63
Pantalla FUNCIÓN.....	64
Pantalla de lista.....	64
<b>USB.....</b>	<b>65</b>
Conexión de un dispositivo USB.....	65
Funcionamiento básico de USB.....	65
<b>Sintonizador.....</b>	<b>66</b>
Funcionamiento básico del sintonizador.....	66
Manejo de la memoria.....	67
<b>SiriusXM®.....</b>	<b>67</b>
Funcionamiento básico de SiriusXM®.....	67
<b>Control de Bluetooth.....</b>	<b>69</b>
Registre desde el dispositivo Bluetooth.....	69
Usar la unidad de manos libres.....	70
<b>Control del audio.....</b>	<b>73</b>
<b>Conexión/Instalación.....</b>	<b>75</b>
Antes de la instalación.....	75
Instalación de la unidad.....	76
<b>Apéndice.....</b>	<b>80</b>
Especificaciones.....	80
Acerca de esta unidad.....	80

## Antes de la utilización

### Acerca de la Guía de inicio rápido

Esta Guía de inicio rápido describe las funciones básicas de esta unidad.

Para obtener información y detalles sobre las operaciones, consulte el MANUAL DE INSTRUCCIONES en el siguiente sitio web:

<<https://www.jvc.net/cs/car/>>

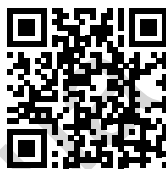

El Manual de instrucciones está sujeto a cambios por modificaciones de las especificaciones, etc.

Asegúrese de descargar la última edición del Manual de instrucciones a título de referencia.

### Cómo leer este manual

- Las pantallas y paneles que se incluyen en este manual son ejemplos utilizados para ofrecer explicaciones de las distintas operaciones. Por este motivo, pueden diferir de las pantallas o paneles reales, y algunos patrones de visualización también pueden ser diferentes.
- **Idioma para las indicaciones:** En este manual, se utilizan indicaciones en inglés para las explicaciones. Puede seleccionar el idioma para las indicaciones desde el menú **SETUP**. Consulte el Manual de instrucciones.

## Precauciones

### ▲ ADVERTENCIAS

#### ■ Para evitar lesiones o incendios, tome las precauciones siguientes:

- Para evitar un cortocircuito, nunca coloque ni deje objetos metálicos (como monedas o herramientas metálicas) dentro de la unidad.
- No mire fijamente la pantalla de la unidad mientras está conduciendo durante un periodo prolongado de tiempo.
- Si tiene problemas durante la instalación, consulte con su distribuidor JVC.

#### ■ Precauciones para el uso de esta unidad

- Cuando compre accesorios opcionales, pregunte a su distribuidor JVC si dichos accesorios son compatibles con su modelo y en su región.
- Puede seleccionar el idioma de visualización de los menús, las etiquetas de archivos de audio, etc. Consulte el Manual de instrucciones.
- La función Radio Data System o Radio Broadcast Data System no funcionará en lugares donde no existan emisoras compatibles con este servicio.

#### ■ Cómo proteger el monitor

- Para proteger el monitor de posibles daños, no lo utilice con un bolígrafo con punta de bola ni con ninguna herramienta similar de punta afilada.

#### ■ Limpieza de la unidad

- Si la placa frontal de la unidad está manchada, límpiela con un paño suave y seco, como un paño de silicio. Si la placa frontal está muy manchada, límpiela con un paño humedecido con detergente neutro y, después, vuelva a limpiarla con un paño suave y seco.

### NOTA

- Si aplica un limpiador en spray directamente sobre la unidad, puede dañar sus componentes mecánicos. Si limpia la placa frontal con un paño áspero o con líquido volátil, como disolvente o alcohol, puede rayar la superficie o borrar los caracteres impresos.

#### ■ Cómo reiniciar su unidad

- Si la unidad o el equipo conectado no funcionan correctamente, reinicie la unidad.1 Pulse el botón <Reset>. La unidad vuelve a los ajustes de fábrica.



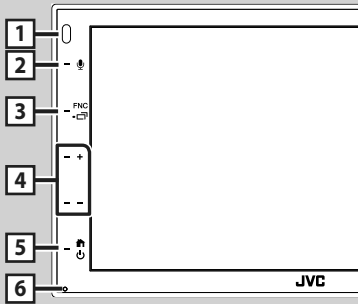

# Funciones básicas

## Funciones de los botones del panel frontal



### NOTA

- Los paneles que se incluyen en este manual son ejemplos utilizados para ofrecer explicaciones de las distintas operaciones. Por esta razón, pueden diferir de los paneles que se visualizan en realidad.

	Nombre • Función
1	Sensor remoto • Recibe la señal del control remoto.
2	 • Muestra la pantalla Reconocimiento de voz.
3	<b>FNC</b> /  • Muestra la pantalla FUNCIÓN. • Pulsarlo durante 1 segundo muestra la pantalla APLICACIÓN (Apple CarPlay/Android Auto).
4	+ , - (volumen) • Ajusta el volumen. Si continúa presionando +, el volumen aumentará hasta 15.
5	 • Muestra la pantalla de inicio (P.61). • Si se pulsa durante 1 segundo, se apaga la unidad. • Si la unidad está apagada, la enciende.
6	Restablecer • Si la unidad o el equipo conectado no funcionan correctamente, la unidad restablece la configuración inicial al pulsar este botón.

## Poner en marcha la unidad

El método de encendido es diferente dependiendo del modelo.

- 1 Pulse el botón .



- La unidad se pone en marcha.

- Para apagar la unidad:

- 1 Pulse el botón  durante 1 segundo.

### NOTA

- La primera vez que se pone en marcha la unidad después de la instalación, debe realizarse la configuración inicial (P.59).

## Inicio

### Configuración inicial

Realice esta configuración si es la primera vez que utiliza esta unidad.

#### 1 Ajuste cada elemento del modo siguiente.

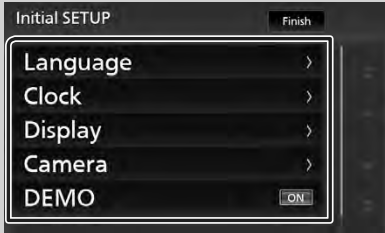

##### ■ Language

Seleccione el idioma utilizado para la pantalla de control y los elementos de configuración. La opción predeterminada es "American English(en)".

- ① Toque **Language**.
- ② Toque **Language Select**.
- ③ Seleccione el idioma deseado.
- ④ Toque

##### ■ Clock

Ajusta el reloj.

Para más información sobre el manejo, consulte **Ajustes del calendario/reloj (P.59)**.

##### ■ Display

Ajustar la imagen en la pantalla.

- ① Toque **Display**.
- ② Toque **Background**.
- ③ Seleccione la imagen.
- ④ Toque

Para más información sobre el manejo, consulte el manual de instrucciones.

##### ■ Camera

Ajusta los parámetros de la cámara.

- ① Toque **Camera**.
- ② Ajuste cada uno de los elementos y toque .

Para más información sobre el manejo, consulte el manual de instrucciones.

##### ■ DEMO

Configure el modo de demostración. La opción predeterminada es "ON".

- ① Toque **DEMO** y ajuste **ON** u **OFF**.

#### 2 Toque **Finish**.



#### NOTA

- Estas opciones pueden ajustarse desde el menú CONFIGURACIÓN.

### Ajustes del calendario/reloj

#### 1 Pulse el botón **FNC**.

- Aparece la pantalla **FUNCIÓN**.

#### 2 Toque



- Aparece la pantalla **SETUP Menu**.

**3** Toque **User Interface**.



► Aparecerá la pantalla User Interface.

**4** Toque **Clock Adjust**.

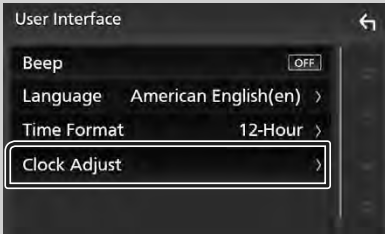

**5** Ajuste la fecha y, a continuación, ajuste la hora.

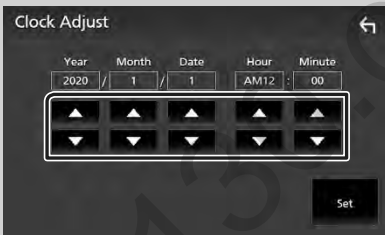

**6** Toque **Set**.

**NOTA**

- Desactive **RDS CT** antes de ajustar el reloj. Consulte el Manual de instrucciones.

**Ajuste del volumen**

Para ajustar el volumen (0 a 40), Pulse + para subirlo y pulse - para bajarlo. Si mantiene pulsado + el volumen aumenta de forma continua hasta el nivel 15.



**Operaciones de la pantalla táctil**

Para realizar operaciones en la pantalla, deberá tocar, tocar y mantener pulsado, hojear o deslizar un dedo para seleccionar un elemento, visualizar la pantalla de menú de configuración o cambiar de página, etc.

● **Tocar**

Toque suavemente la pantalla para seleccionar un elemento.

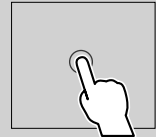

● **Tocar y mantener pulsado**

Toque la pantalla y continúe pulsando hasta que se cambie la visualización o se muestre un mensaje.

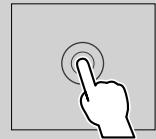

● **Hojear**

Deslice su dedo rápidamente hacia la izquierda o hacia la derecha de la pantalla para cambiar de página.

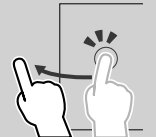

Puede desplazarse arriba/abajo por la pantalla de la lista arrastrándola con el dedo.

● **Deslizar**

Deslice el dedo hacia arriba o hacia abajo en la pantalla para desplazarse por la misma.

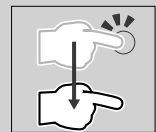

### Control táctil por gestos:

También puede controlar la reproducción moviendo su dedo sobre la pantalla táctil, de la siguiente manera (el control por gestos no está disponible para todas las fuentes).

- Deslizando el dedo hacia arriba/hacia abajo:
  - Funciona igual que al presionar **+** / **-** (medios) en la pantalla de control de USB.
  - Para el Sintonizador, se cambian las emisoras de radio predeterminadas del sintonizador.
- Deslizando el dedo hacia la izquierda/hacia la derecha: Funciona de la misma manera que cuando se presiona **◀◀** / **▶▶**.
- Moviendo el dedo en sentido horario o antihorario: incrementa/disminuye el volumen.

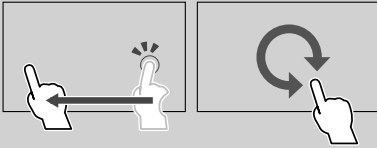

### Descripciones de la pantalla INICIO

La mayoría de las funciones pueden ejecutarse desde la pantalla HOME (inicio).



- |          |   |
|----------|---|
| <b>1</b> | • Iconos de acceso directo a la fuente de reproducción. <b>(P.62)</b> .                                   |
| <b>2</b> | • Información de la fuente actual.<br>• Toque para visualizar la pantalla de control de la fuente actual. |
| <b>3</b> | • Widget  |
| <b>4</b> | • Muestra la pantalla de selección de fuente. <b>(P.62)</b>   |

- |          |  |
|----------|--|
| <b>5</b> | • Visualiza la pantalla del menú CONFIGURACIÓN.  |
| <b>6</b> | • Muestra la pantalla Manos libres. <b>(P.70)</b><br>• Al conectar como Apple CarPlay o Android Auto, funciona como un teléfono proporcionado en Apple CarPlay o Android Auto. |

### Visualización de la pantalla INICIO

- 1** Pulse el botón .

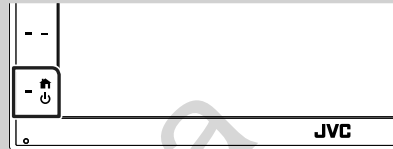

- Aparece la pantalla HOME (inicio).

### Descripciones de la pantalla de selección de fuente

Todas las fuentes y opciones de reproducción se pueden visualizar en la pantalla de selección de fuente.



- |          |  |
|----------|--|
| <b>1</b> | • Cambia la fuente de reproducción.<br>Para las fuentes de reproducción, consulte <b>Selección de la fuente de reproducción (P.62)</b> . |
| <b>2</b> | • Regresa a la pantalla anterior.  |
| <b>3</b> | • Visualiza la pantalla del menú CONFIGURACIÓN.  |

## Selección de la fuente de reproducción

**1** Toque  en la pantalla INICIO.

Desde la pantalla puede seleccionar las siguientes fuentes y funciones.

	<ul style="list-style-type: none"> <li>Cambia a la pantalla de Apple CarPlay desde el iPhone conectado.</li> </ul>
	<ul style="list-style-type: none"> <li>Cambia a la pantalla de Android Auto desde el teléfono inteligente Android conectado. Es necesario conectar un teléfono inteligente Android compatible con Android Auto y ajustar <b>Mode</b> en <b>Android Auto</b>.</li> </ul>
	<ul style="list-style-type: none"> <li>Cambia a la pantalla USB en espejo desde el teléfono inteligente Android conectado. Es necesario conectar el teléfono inteligente Android con la aplicación "Mirroring OA for JVC" instalada y ajustar <b>Mode</b> en <b>Mirroring for Android™</b>.</li> </ul>
	<ul style="list-style-type: none"> <li>Muestra la pantalla Manos libres. <b>(P.70)</b> Si no conecta Apple CarPlay, Android Auto ni un teléfono con Bluetooth y manos libres, se muestra el mensaje "<b>Disconnected</b>" en la pantalla del teléfono. Al conectar como Apple CarPlay o Android Auto, funciona como un teléfono proporcionado en Apple CarPlay o Android Auto.</li> </ul>
	<ul style="list-style-type: none"> <li>Cambia a la emisión de radio. <b>(P.66)</b></li> </ul>
	<ul style="list-style-type: none"> <li>Reproduce un reproductor de audio Bluetooth.</li> </ul>
	<ul style="list-style-type: none"> <li>Reproduce archivos en un dispositivo USB. <b>(P.65)</b></li> </ul>
	<ul style="list-style-type: none"> <li>Cambia a un componente externo conectado al terminal de entrada AV-IN.</li> </ul>
	<ul style="list-style-type: none"> <li>Cambia a la transmisión de radio satelital SiriusXM®. <b>(P.67)</b></li> </ul>
	<ul style="list-style-type: none"> <li>Desactiva la fuente AV. <b>(P.62)</b></li> </ul>

## Para desactivar la fuente AV

**1** Toque  en la pantalla INICIO.

**2** Toque **AV Off**.

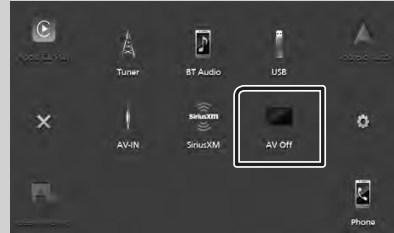

## Descripciones de la pantalla de control de fuente

Existen funciones que pueden ejecutarse desde la mayoría de las pantallas.

Indicadores



Menú secundario



### 1 TEL /

Información del dispositivo Bluetooth conectado.

### 2 **Icono de todas las fuentes**

Muestra todas las fuentes.

### 3 **Pantalla secundaria**

-  / : La pantalla secundaria cambia cada vez que la toca. También puede cambiar la pantalla secundaria moviendo el dedo hacia la izquierda o hacia la derecha en la pantalla.
- Indicadores: Muestra el estado de la fuente actual, etc.
  - **MUTE**: La función de silenciamiento está activa.
  - **LOUD**: La función de control de volumen está activada.
- Menú secundario
  - **DIM**: Funcionamiento cuando se pulsa el icono: El primer toque oscurece la pantalla, el segundo toque la oscurece aún más y el tercer toque restablece el brillo original de la pantalla.
  - : Muestra la pantalla Ecuador gráfico. **(P.74)**
  - : Muestra la pantalla APLICACIÓN (Apple CarPlay/Android Auto).

### 4

Toque para visualizar la pantalla Manos libres.

**(P.70)**

Al conectar como Apple CarPlay o Android Auto, funciona como un teléfono proporcionado en Apple CarPlay o Android Auto.



## Pantalla FUNCIÓN

1 Pulse el botón **FNC**.



➤ Aparece la pantalla FUNCIÓN.

2 Toque para visualizar la pantalla FUNCIÓN.



El contenido del menú es el siguiente.

	• Visualiza la pantalla del menú CONFIGURACIÓN.
	• Muestra la pantalla APLICACIÓN (Apple CarPlay/Android Auto).
	• Muestra la pantalla Ajustar pantalla.
	• Muestra la vista de la cámara.
	• Muestra la pantalla de selección de fuente. <b>(P.62)</b>
	• Desactiva la visualización. <b>(P.64)</b>
	• Muestra la pantalla Audio. <b>(P.73)</b>
	• Cierra la pantalla FUNCIÓN.

## Apagar la pantalla

1 Seleccione en la pantalla FUNCIÓN.



● Para encender la pantalla

1 Toque la pantalla.

## Pantalla de lista

Existen teclas de funciones comunes en las pantallas de listas de la mayoría de las fuentes.



Visualiza la ventana de selección del tipo de lista.



Muestra la lista de archivos de música/películas.



Desplaza el texto visualizado.



Aquí se muestran teclas con varias funciones.

- **Play**: Reproduce todas las pistas de la carpeta que contiene la pista actual.
- **Up** / **Top**: Se desplaza a la jerarquía superior.



Podrá cambiar la página para visualizar más elementos pulsando / .

- / : Muestra la página superior o inferior.



Regresa a la pantalla anterior.

### NOTA



- No se muestran los botones que no pueden ser activados desde la pantalla de lista.

# USB

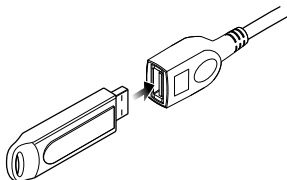

## Conexión de un dispositivo USB

- 1 Conecte el dispositivo USB con el cable USB. (P.78)



- 2 Pulse el botón .
- 3 Toque .
- 4 Toque **USB**. (P.62)

## Desconecte el dispositivo USB

- 1 Pulse el botón .
- 2 Toque .
- 3 Toque una fuente distinta de **USB**.
- 4 Desconecte el dispositivo USB.

## Dispositivos USB que pueden utilizarse

En esta unidad puede utilizar un dispositivo USB de tipo de almacenamiento masivo.







La palabra "USB device" que aparece en este manual se refiere a un dispositivo de memoria flash.

## Funcionamiento básico de USB

La mayoría de las funciones pueden controlarse desde la pantalla de control de fuentes y de reproducción.

### Pantalla de control







- 1  : Repite la pista/carpeta actual. Cada vez que se toca el botón, el modo de repetición cambia en la siguiente secuencia: Repetición de archivo () , repetición de carpeta () , repetir todo ()
- 2  : Reproduce aleatoriamente todas las pistas de la carpeta actual. Cada vez que se toca la tecla, el modo aleatorio cambia en la siguiente secuencia: Archivo aleatorio () , aleatorio desactivado ()

### 2 Información de pista

Muestra la información del archivo actual.

### 3 Teclas de operación

-  : Busca una pista/un archivo. Para obtener más detalles sobre la función de búsqueda, consulte el manual de instrucciones.
-   : Busca la pista o archivo anterior/siguiente. Mantenga pulsado para avanzar o retroceder rápidamente.
-  : Inicia la reproducción o hace una pausa.
-  : Toque para silenciar o anular el silenciamiento.

# Sintonizador

## Funcionamiento básico del sintonizador

La mayoría de las funciones pueden controlarse desde la pantalla de control de fuentes.

Para acceder a la fuente Sintonizador, toque el icono **Tuner** en la pantalla de selección de fuente. (P.62)

Pantalla de control



Abra el cajón



### 1 Pantalla de información

Muestra información sobre la emisora actual:  
Frecuencia

Tochar le permite alternar entre el contenido A y el contenido B.

- Contenido A: Nombre de PS, radio texto, género PTY
- Contenido B: Radio Texto plus, artista del título

**Preset#**: Número de presintonía

### 2 Modo de búsqueda

El modo de búsqueda cambia en el orden siguiente: **AUTO1**, **AUTO2**, **MANUAL**.

- **AUTO1**: Sintoniza automáticamente una emisora con buena recepción.
- **AUTO2**: Sintoniza las emisoras de la memoria una después de la otra.
- **MANUAL**: Cambia a la frecuencia siguiente manualmente.

### 3 Teclas de operación

- : Sintoniza una emisora. El método de cambio de frecuencia puede modificarse (consulte 2 en la tabla).
- : Toque para silenciar o anular el silenciamiento.

### 4 Lista de preselección

- Toque el lado derecho de la pantalla para visualizar la lista de presintonías. Toque de nuevo para cerrar la lista.
- Restaura la emisora memorizada.
- Si se toca durante 2 segundos, almacena en la memoria la emisora de recepción actual.

### 5 Panel de funciones

Toque el lado izquierdo de la pantalla para mostrar el panel de funciones. Toque de nuevo para cerrar el panel.

- **TI** (FM solamente): Activa el modo de información del tráfico. Para obtener más información, consulte el manual de instrucciones.
- **SETUP**: Muestra la pantalla CONFIGURACIÓN de sintonizador. Para obtener más información, consulte el manual de instrucciones.
- **AME**: Preajusta emisoras automáticamente. Para obtener más información, consulte el manual de instrucciones.
- **PTY** (solo FM): Busca una emisora estableciendo el tipo de programa. Para obtener más información, consulte el manual de instrucciones.
- **MONO** (FM solamente): Selecciona la recepción monoaural.

### 6 FM AM

Cambia la banda.

### 7 Elementos indicadores

- **ST**: Se está recibiendo una difusión en estéreo.
- **MONO**: La función de forzar monoaural está activa.
- **TI**: Indica el estado de recepción de información de tráfico.
  - Blanco: Se recibe TP.
  - Naranja: No se recibe TP.

## Manejo de la memoria

### Memoria automática

Puede almacenar automáticamente en memoria las emisoras con buena recepción.

#### 1 Toque la tecla de la banda deseada.



#### 2 Toque **▶** en el lado izquierdo de la pantalla.

Toque **AME**.

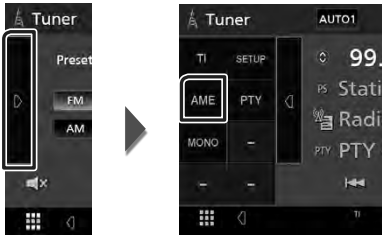

► Aparecerá una pantalla de confirmación.

#### 3 Toque **Yes**.

► Se inicia la memoria automática.

### Memoria manual

La emisora que se está recibiendo actualmente puede almacenarse en la memoria.

#### 1 Seleccione una emisora que desee almacenar en la memoria.

#### 2 Toque durante 2 segundos **FM#** (#: 1-24) o **AM#** (#: 1-12) donde desee almacenar la emisora.

## SiriusXM®

### Funcionamiento básico de SiriusXM®

SiriusXM® es el único capaz de ofrecerle más de lo que desea escuchar, todo en un solo lugar. Consiga más de 140 canales, incluyendo música sin anuncios y los mejores deportes, noticias, tertulias, comedias y entretenimiento. Bienvenido al mundo de la radio satelital. Serán necesarios un sintonizador para vehículos SiriusXM y una suscripción. Para obtener más información, visite [www.siriusxm.com](http://www.siriusxm.com).

Para escuchar la fuente SiriusXM, toque el ícono **SiriusXM** en la pantalla de selección de fuente. (P.62)

#### Activación de la suscripción

- Compruebe el ID de su radio.  
El ID de la radio satelital SiriusXM será necesario para la activación y podrá encontrarlo sintonizando el canal 0 así como en la etiqueta del sintonizador SiriusXM Connect y en su envoltorio.  
El ID de la radio no incluye las letras I, O, S ni F.
- Active el sintonizador para vehículos SiriusXM Connect utilizando uno de los siguientes dos métodos:
  - Para los usuarios de EE. UU.  
En línea: Visite [www.siriusxm.com/activatenow](http://www.siriusxm.com/activatenow)  
Teléfono: Contacte con el centro de atención al cliente de SiriusXM en el 1-866-635-2349
  - Para los usuarios en Canadá:  
En línea: Visite <https://www.siriusxm.ca/help/activation-help/>  
Teléfono: Contacte con el centro de atención al cliente de XM en el 1-877-438-9677

#### NOTA

- Para utilizar la radio satelital SiriusXM®, se requiere el accesorio opcional.

**Pantalla de control**



**Abra el cajón**



**1 Pantalla de información**

- Muestra la información del canal actual:  
Nombre del canal  
**P#**: Número de presintonía  
**#CH**: Número de canal  
Tocar le permite alternar entre el contenido A y el contenido B.
  - Contenido A: Nombre del intérprete, título de la canción
  - Contenido B: Información del contenido, nombre de categoría

**NOTA**  
• Durante la obtención de contenido, "Waiting" aparece en pantalla.

**2 Botón de banda**

Cambia entre bandas. (SXM1/SXM2/SXM3)

**3 Ilustraciones/panel de funciones**

- Muestra las ilustraciones del álbum para la mayoría de los canales de música de SiriusXM.
- Toque el icono de la pantalla para visualizar el panel de funciones. Toque para cerrar el panel.
  - **Direct Channel**: Toque e introduzca el número deseado. Para obtener más información, consulte el manual de instrucciones.
  - **SETUP**: Toque para visualizar la pantalla CONFIGURACIÓN de SiriusXM. Para obtener más información, consulte el manual de instrucciones.
  - **Replay/Live**: Toque para activar o desactivar el modo de repetición. Consulte el Manual de instrucciones.

**4 Teclas de operación**

- : Visualice la pantalla de Búsqueda de categoría. Para obtener más detalles sobre la función de búsqueda, consulte el manual de instrucciones.
- : Inicia la reproducción o hace una pausa. Consulte el Manual de instrucciones.
- **CH** **CH** : Selecciona un canal.
- : Toque para silenciar o anular el silenciamiento.

**5 Preset list**

- Toque el icono de la pantalla para visualizar la lista de presintonías. Toque para cerrar la lista.
- Recupera el canal memorizado.
- Si se toca durante 2 segundos, almacena en la memoria el canal que se recibe actualmente.

# Control de Bluetooth

## ■ Acerca de los teléfonos móviles y los reproductores de audio Bluetooth

Esta unidad cumple las siguientes especificaciones Bluetooth:

Versión

Bluetooth Ver. 4.1

Perfil

Teléfono móvil:

HFP (Perfil de manos libres)

SPP (Perfil de puerto serie)

PBAP (Perfil de acceso a agenda telefónica)

Reproductor de audio :

A2DP (Perfil avanzado de distribución de audio)

AVRCP (Perfil de mando a distancia de audio/vídeo)

Códec de sonido

SBC, AAC

### NOTA

- La unidad compatible con la función Bluetooth tiene la certificación de conformidad con la norma Bluetooth con arreglo al procedimiento estipulado por Bluetooth SIG.
- Sin embargo, puede que dichas unidades no puedan comunicarse con ciertos tipos de teléfono móvil.

## Registre desde el dispositivo Bluetooth

Es necesario registrar el reproductor de audio o el teléfono móvil Bluetooth antes de utilizarlos en esta unidad con la función Bluetooth.

- 1 Active la función Bluetooth en su teléfono inteligente/teléfono móvil.**
- 2 Busque la unidad ("KW-M\*\*\*\*") en su teléfono inteligente/móvil.**
- 3 Accione su smartphone/teléfono móvil en conformidad con los mensajes visualizados.**

- **Confirme la petición en el teléfono inteligente/móvil.**



- **Si se requiere un código PIN, introduzca el código PIN ("0000").**

- 4 Pulse el botón FNC.**
  - Aparece la pantalla FUNCIÓN.

- 5 Toque .**



- Aparece la pantalla SETUP Menu.

## 6 Toque Bluetooth.



➤ Aparece la pantalla Bluetooth SETUP.

## 7 Toque **Select Device** en la pantalla CONFIGURACIÓN de Bluetooth.



## 8 Toque el icono **[C >]** del dispositivo al que desee conectarse.



### NOTA

• Si el icono está iluminado, significa que la unidad utilizará este dispositivo.

## Para eliminar el dispositivo Bluetooth registrado

### 1 Toque **Delete**.

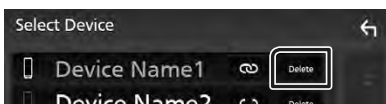

➤ Aparece el mensaje de confirmación.

### 2 Toque **Yes**.

## Usar la unidad de manos libres

Puede usar la función de teléfono conectando un teléfono Bluetooth a esta unidad.

### NOTA

- Mientras Apple CarPlay o Android Auto se conectan, no se puede usar la función de manos libres Bluetooth. Solo puede usar la función de manos libres Apple CarPlay o Android Auto.

## Realice una llamada

### 1 Toque **Phone**.



➤ Aparece la pantalla Hands Free.

### 2 Seleccione un método de marcación.



- : Llamar usando los registros de llamada almacenados
- : Llamar usando la agenda telefónica
- : Llamar usando el número preseleccionado
- : Llamar introduciendo un número telefónico
- : Reconocimiento de voz
- : CONFIGURACIÓN de Bluetooth

## ● CONFIGURACIÓN de Bluetooth

1) Toque .

Aparece la pantalla Bluetooth SETUP.

### NOTA

- Los iconos de estado para la batería y la antena mostrados en la unidad de control pueden no coincidir con los mostrados en el teléfono móvil.
- La configuración del teléfono móvil en modo privado puede desactivar la función manos libres.

## Llamar usando datos de llamada almacenados

1 Toque .

2 Seleccione el número de teléfono de la lista.



## Llamar introduciendo un número telefónico

1 Toque .

2 Introducir un número de teléfono con las teclas numéricas.



3 Toque .

## Llamar usando el número preseleccionado

1 Toque .

2 Toque el nombre o número de teléfono.



## Llamar usando la agenda telefónica

1 Toque .

2 Seleccione en la lista la persona a la que desea llamar.

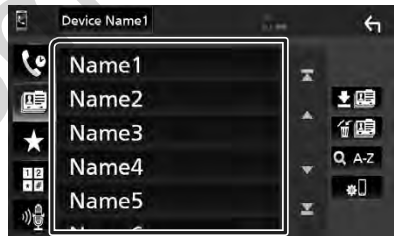

3 Seleccione el número de teléfono de la lista.

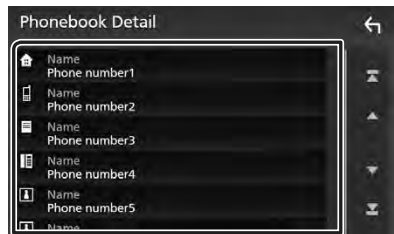



### NOTA

- Si no se descargó ninguna agenda telefónica, tocar **Download Phonebook Now** iniciará la descarga de la agenda telefónica.



## Reciba una llamada

- 1 Toque  para contestar una llamada telefónica o toque  para rechazarla.



### NOTA

- Mientras se controla la vista de cámara, esta pantalla no se mostrará aunque reciba una llamada. Para mostrar esta pantalla, vuelva a colocar el mando de cambios del coche en la posición de conducción.

## Para finalizar una llamada

- 1 Mientras habla, toque .

## Operaciones durante una llamada



### ● Ajustar el volumen del receptor

Pulse el botón  o .





### ● Emitir el tono de llamada

Toque **DTMF** para visualizar la pantalla de entrada de tono.

Puede enviar tonos tocando las teclas correspondientes de la pantalla.

### ● Cambiar la salida de voz

Tocar  /  cada vez cambia la salida de voz entre el teléfono móvil y el altavoz.

### ● Llamada en espera

Cuando reciba una llamada mientras esté atendiendo otra, podrá contestar a la nueva llamada tocando . La llamada actual quedará en espera.

Cada vez que toque , cambiará la persona con la que hable.

Cuando toca , la llamada actual finalizará y cambiará a la llamada en espera.

# Control del audio

Puede ajustar diversas opciones como el balance o el subwoofer.

- 1 Pulse el botón **FNC**.  
 > Aparece la pantalla FUNCIÓN.
- 2 Toque .



## Control general del audio

- 1 Pulse el botón **FNC**.  
 > Aparece la pantalla FUNCIÓN.
- 2 Toque .
- 3 Toque **Fader / Balance**.

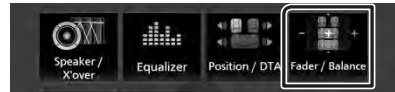

- 4 Ajuste cada elemento del modo siguiente.

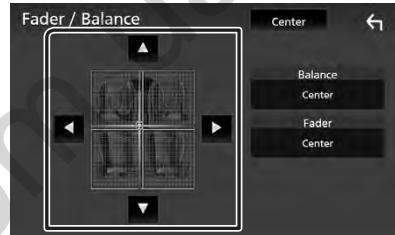

### ■ Fader / Balance

Ajuste el balance alrededor de la zona de contacto.

◀ y ▶ ajustan el balance izquierdo y derecho.

▲ y ▼ ajustan el balance delantero y trasero.

### ■ Center

Borre el ajuste.

## Control del ecualizador

Puede ajustar el ecualizador seleccionando el ajuste optimizado para cada categoría.

### 1 Pulse el botón **FNC**.

➤ Aparece la pantalla **FUNCIÓN**.

### 2 Toque .

➤ Aparece la pantalla de audio (Audio).

### 3 Toque **Equalizer**.



### 4 Toque la pantalla y ajuste a su gusto el ecualizador gráfico.

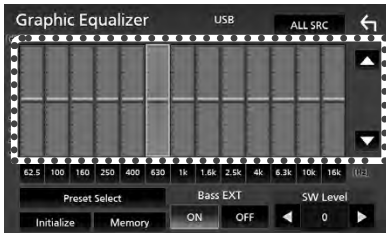

#### ■ **ALL SRC**

Aplique el ecualizador ajustado a todas las fuentes. Toque **ALL SRC** y entonces toque **OK** en la pantalla de confirmación.

#### ■ **Nivel de ganancia (área de marco punteado)**

Ajuste la ganancia tocando cada una de las barras de frecuencia.

Podrá seleccionar la barra de frecuencia y ajustar su nivel usando ▲, ▼.

#### ■ **Preset Select**

Muestra la pantalla para recuperar la curva del ecualizador preajustado.

#### ■ **Initialize**

La curva EQ actual vuelve a plana.

#### ■ **Memory**

Guarda la curva del ecualizador ajustada entre "User1" y "User3".

#### ■ **Bass EXT (ajustes avanzados de graves)**

Si está activo, las frecuencias inferiores a 62,5 Hz se establecen al mismo nivel de ganancia que 62,5 Hz.

#### ■ **SW Level**

Ajusta el volumen del subwoofer.

# Conexión/Instalación

## Antes de la instalación

Antes de la instalación de esta unidad, tenga en cuenta las precauciones siguientes.

### ▲ADVERTENCIAS

- Si conecta el cable de encendido (rojo) y el cable de la batería (amarillo) al chasis del automóvil (tierra), podría producir un cortocircuito y esto, a su vez, un incendio. Conecte siempre esos cables a la fuente de alimentación que pasa por la caja de fusibles.
- No corte el fusible del cable de ignición (rojo) y el cable de la batería (amarillo). El suministro de energía debe conectarse a los cables por medio del fusible.

### ▲PRECAUCIÓN

- Instale esta unidad en la consola de su vehículo. No toque la parte metálica de esta unidad durante e inmediatamente después del uso de la unidad. Las partes metálicas, tales como el disipador de calor o la carcasa, pueden estar muy calientes.

### NOTA

- La instalación y el cableado de este producto requieren habilidad y experiencia. Para mayor seguridad, deje el trabajo de montaje y cableado en manos de profesionales.
- Asegúrese de utilizar para la unidad una fuente de alimentación de 12 V CC con conexión a tierra negativa.
- No instale la unidad en un sitio expuesto a la luz directa del sol, o excesivamente húmedo o caluroso. Además deberá evitar sitios con mucho polvo o con posibilidad de salpicaduras de agua.
- No utilice sus propios tornillos. Utilice solo los tornillos suministrados. El uso de tornillos diferentes podría causar daños en la unidad.
- Si la alimentación no se enciende (se visualiza "There is an error in the speaker wiring. Please check the connections." (Hay un error en el cableado del altavoz. Por favor, compruebe las conexiones)), puede que el cable del altavoz haya sufrido un cortocircuito o que haya tocado el chasis del vehículo y se haya activado la función de protección. Por lo tanto, el cable del altavoz debe ser revisado.
- Si el encendido de su automóvil no está provisto





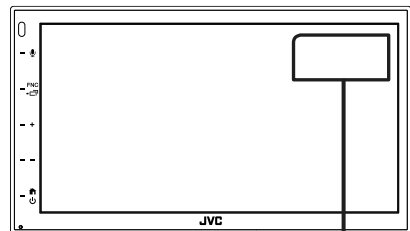

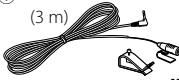

de la posición ACC, conecte los cables de encendido a una fuente de alimentación que pueda conectarse y desconectarse con la llave de encendido. Si conecta el cable de encendido a una fuente de alimentación con un suministro de voltaje constante, como con los cables de la batería, la batería puede agotarse.

- Si la consola tiene una tapa, asegúrese de instalar la unidad de forma que el panel frontal no golpee la tapa al abrirse o cerrarse.
- Si se funden los fusibles, asegúrese primero de que los cables no están en contacto pues pueden ocasionar un cortocircuito, luego reemplace el fusible dañado por uno nuevo que tenga la misma potencia de servicio.
- Aísle los cables no conectados con una cinta de vinilo u otro material similar. Para evitar cortocircuitos, no retire las tapas de los extremos de los cables o terminales no conectados.
- Conecte los cables de los altavoces a cada uno de los terminales correspondientes. La unidad se puede dañar o no funcionar si comparte los cables  $\ominus$  o los conecta a tierra a cualquier parte metálica del vehículo.
- Si se han conectado solamente dos altavoces al sistema, enchufe los conectores a ambos terminales de salida delanteros o a ambos terminales de salida traseros (es decir, no mezcle terminales delanteros y traseros). Por ejemplo, si conecta el conector  $\oplus$  del altavoz izquierdo a un terminal de salida delantero, no conecte el conector  $\ominus$  a un terminal de salida posterior.
- Después de instalar la unidad, compruebe que las luces de freno, las luces intermitentes, el limpiaparabrisas, etc., funcionan satisfactoriamente.
- No presione con fuerza la superficie del panel al instalar la unidad en el vehículo. De lo contrario, pueden producirse marcas, daños o fallos.
- La recepción podría ser baja si existen objetos metálicos cerca de la antena Bluetooth.

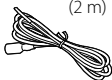

Unidad de antena Bluetooth

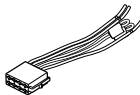
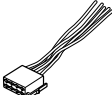
## Accesorios suministrados para la instalación

① (3 m)  x1	②  x1
③ (2 m)  x1	④  x1
⑤  (M5 x 6 mm) x6	⑥  (M5 x 8 mm) x6
⑦  x1	⑧  x1
⑨  x2	

## Procedimiento de instalación

- 1) Para evitar cortocircuitos, retire la llave del encendido y desconecte el terminal  $\ominus$  de la batería.
- 2) Realice de forma adecuada las conexiones de los cables de entrada y salida para cada unidad.
- 3) Conecte el cable al mazo de conductores.
- 4) Tome el conector B (accesorio ⑧) en el mazo de cables y conéctelo al conector de altavoz de su vehículo.
- 5) Tome el conector A (accesorio ⑦) en el mazo de cables y conéctelo al conector de alimentación externa de su vehículo.
- 6) Conecte el mazo de cables a la unidad.
- 7) Instale la unidad en el automóvil.
- 8) Conecte nuevamente el terminal  $\ominus$  de la batería.
- 9) Pulse el botón Restablecer.

## Instalación de la unidad

### Coches no japoneses

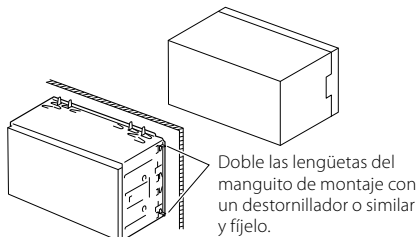

### NOTA

- Asegúrese de que la unidad esté firmemente instalada en su lugar. Si la unidad está en una posición inestable, es posible que no funcione correctamente (por ejemplo, el sonido puede interrumpirse).

### Automóviles japoneses

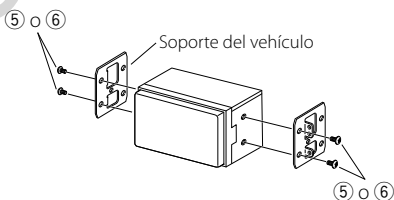

### Marco

- 1) Conecte el accesorio ② a la unidad.

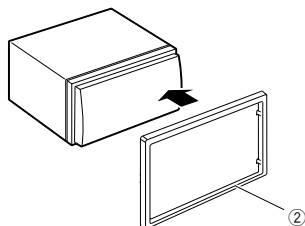

## Unidad de micrófono

- 1) Compruebe la posición de instalación del micrófono (accesorio ①).
- 2) Limpie la superficie de instalación.
- 3) Extraiga el separador del micrófono (accesorio ①) y fije el micrófono en la posición que se indica a continuación.
- 4) Conecte el cable del micrófono a la unidad de forma segura en varias posiciones mediante cinta u otro método.
- 5) Ajuste la dirección del micrófono (accesorio ①) hacia el conductor.

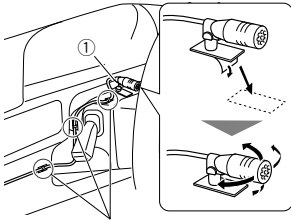

Fije un cable con una cinta adhesiva de uso comercial.

### NOTA

- Cambie los clips si es necesario.

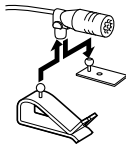

## Desmontaje de la placa embellecedora

- 1) Use la llave de extracción (accesorio ④) para extraer las cuatro pestañas (dos en la parte izquierda, dos en la parte derecha).

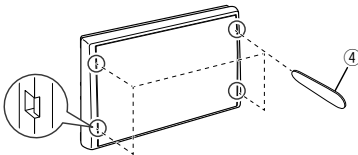

- 2) Tire de la placa hacia adelante.

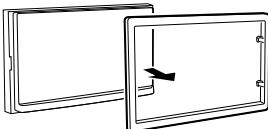

## Retirada de la unidad

- 1) Retire el marco según las indicaciones del paso 1 de "Desmontaje de la placa embellecedora".
- 2) Introduzca la llave de extracción (accesorio ⑨) profundamente en la ranura tal y como se muestra. (El saliente en la punta de la tecla de extracción debe mirar hacia la unidad).

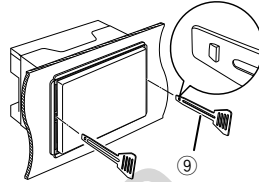

- 3) Con la llave de extracción introducida asegurada, inserte la otra llave de extracción en la ranura.

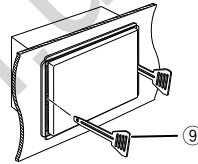

- 4) Saque la unidad hasta la mitad.

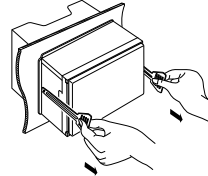

### NOTA

- Tenga cuidado de no hacerse daño con los pasadores de bloqueo de la llave de extracción.

- 5) Termine de sacar la unidad con las manos, prestando atención para no dejarla caer.

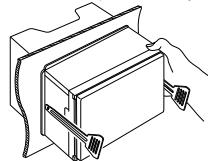

## Conectar los cables a los terminales

Azul claro/Amarillo (cable del mando a distancia de la dirección)

**STEREING WHEEL/ WHEEL/ STEERING WHEEL**  
Al mando a distancia de la dirección  
Para utilizar la función de mando a distancia en el volante es necesario un adaptador remoto exclusivo (no suministrado) apropiado para su vehículo.

**PRK SW**  
Luz verde (Cable del sensor de aparcamiento)  
Accesorio ③: Cable de extensión de estacionamiento

Realice la conexión en el arnés del interruptor de detección del freno de aparcamiento del vehículo.

Para mayor seguridad, asegúrese de conectar el sensor de estacionamiento.

**REVERSE**  
Morado/blanco (Cable del sensor de marcha atrás)

Conecte el mazo de la luz de marcha atrás del vehículo cuando utilice una cámara de visión trasera opcional.

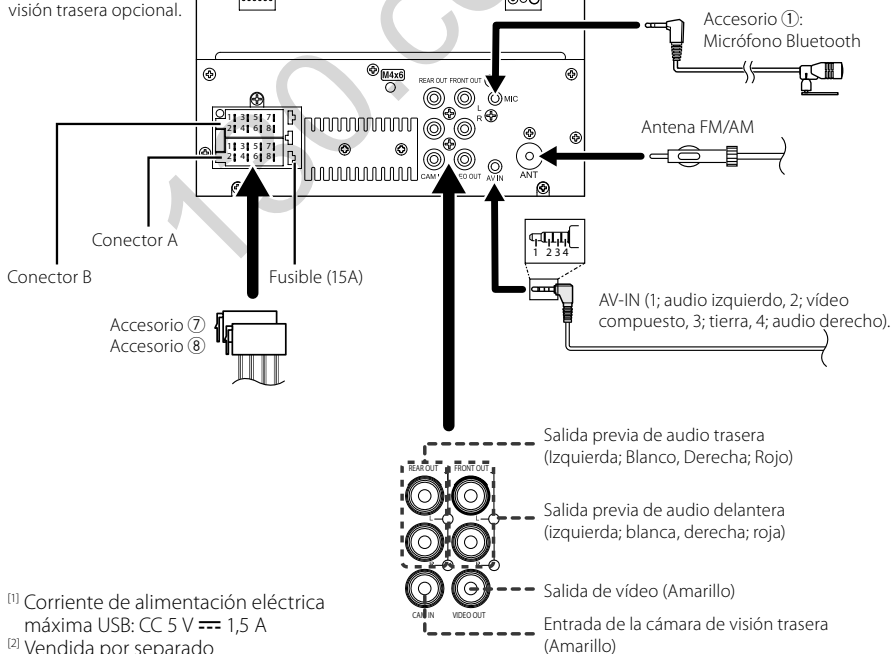

[1] Corriente de alimentación eléctrica máxima USB: CC 5 V = 1,5 A

[2] Vendida por separado

## Conexión de un iPhone/Android

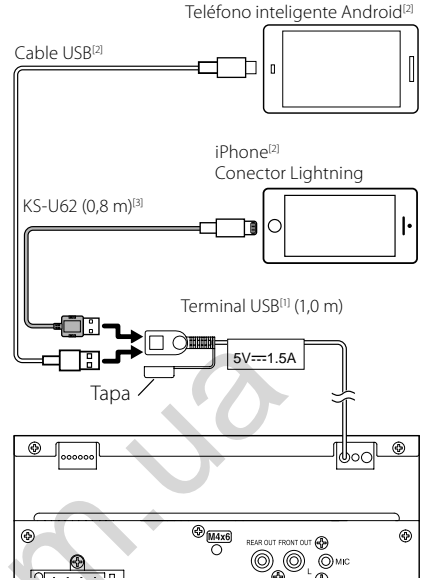
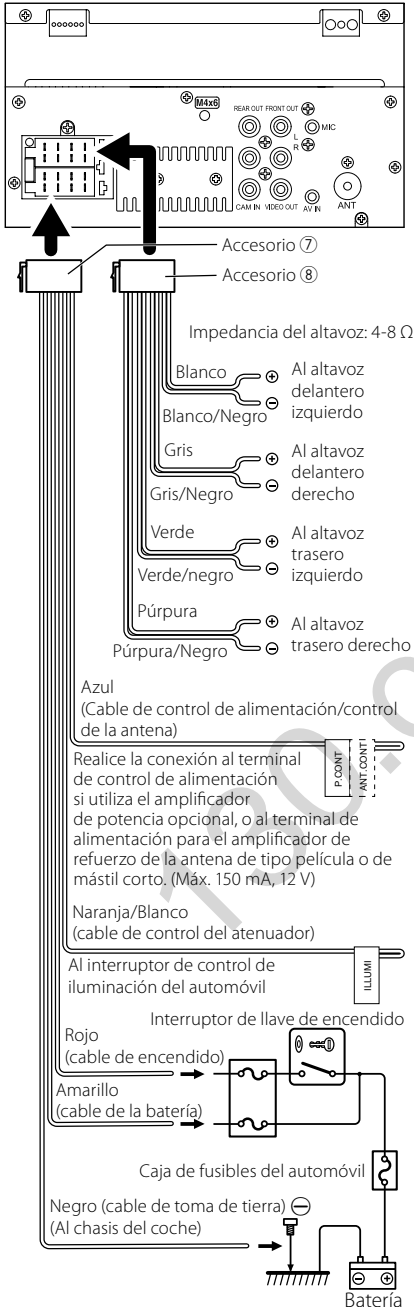

[1] Corriente de alimentación máxima del iPhone: CC 5 V --- 1,5 A

[2] Vendita por separado

[3] Accesorio opcional



# Apéndice

## Especificaciones

### ■ Sección de Bluetooth

Frecuencia

: 2,402 – 2,480 GHz

Potencia de salida de RF (EIRP)

: +8 dBm (prom.), potencia de clase 1

### ■ General

Voltaje de funcionamiento

: Batería de coche de 12 V CC

Impedancia del altavoz

: 4 – 8 Ω

**Las especificaciones se encuentran sujetas a cambios sin previo aviso.**

## Acerca de esta unidad

### ■ Derechos de autor

- La marca Bluetooth® y sus logotipos son marcas registradas propiedad de Bluetooth SIG, Inc., y cualquier uso de los mismos por JVC/KENWOOD Corporation se realiza bajo licencia. El resto de marcas comerciales y nombres comerciales corresponden a sus respectivos propietarios.
- Windows Media is a registered trademark or trademark of Microsoft Corporation in the United States and/or other countries.
- This product is protected by certain intellectual property rights of Microsoft. Use or distribution of such technology outside of this product is prohibited without a license from Microsoft.
- Use of the Made for Apple badge means that an accessory has been designed to connect specifically to the Apple product(s) identified in the badge, and has been certified by the developer to meet Apple performance standards. Apple is not responsible for the operation of this device or its compliance with safety and regulatory standards. Please note that the use of this accessory with an Apple product may affect wireless performance.
- Apple, iPhone and Lightning are trademarks of Apple Inc., registered in the U.S. and other countries.
- Apple, Siri, Apple CarPlay and Apple CarPlay logo are trademarks of Apple Inc., registered in the U.S. and other countries.
- App Store is a service mark of Apple Inc., registered in the U.S. and other countries.
- Sirius, XM and all related marks and logos are trademarks of Sirius XM Radio Inc. All rights reserved.
- IOS is a trademark or registered trademark of Cisco in the U.S. and other countries and is used under license.
- Google, Android, Google Play and Android Auto are trademarks of Google LLC.
- To use Android Auto on your car display, you'll need an Android Auto compatible vehicle or aftermarket stereo, an Android phone running Android 5.0 or higher, and the Android Auto app.
- Linux® is the registered trademark of Linus Torvalds in the U.S. and other countries.
- THIS PRODUCT IS LICENSED UNDER THE AVC PATENT PORTFOLIO LICENSE FOR THE PERSONAL USE OF A CONSUMER OR OTHER USES IN WHICH IT DOES NOT RECEIVE REMUNERATION TO (i) ENCODE VIDEO IN COMPLIANCE WITH THE AVC STANDARD ("AVC VIDEO") AND/OR (ii) DECODE AVC VIDEO THAT WAS ENCODED BY A CONSUMER ENGAGED IN A PERSONAL ACTIVITY AND/OR WAS OBTAINED FROM A VIDEO PROVIDER LICENSED TO PROVIDE AVC VIDEO. NO LICENSE IS GRANTED OR SHALL BE IMPLIED FOR ANY OTHER USE. ADDITIONAL INFORMATION MAY BE OBTAINED FROM MPEG LA, L.L.C. SEE [HTTP://WWW.MPEGLA.COM](http://www.MPEGLA.COM)

- THIS PRODUCT IS LICENSED UNDER THE MPEG-4 VISUAL PATENT PORTFOLIO LICENSE FOR THE PERSONAL AND NON-COMMERCIAL USE OF A CONSUMER FOR (i) ENCODING VIDEO IN COMPLIANCE WITH THE MPEG-4 VISUAL STANDARD ("MPEG-4 VIDEO") AND/OR (ii) DECODING MPEG-4 VIDEO THAT WAS ENCODED BY A CONSUMER ENGAGED IN A PERSONAL AND NON-COMMERCIAL ACTIVITY AND/OR WAS OBTAINED FROM A VIDEO PROVIDER LICENSED BY MPEG LA TO PROVIDE MPEG-4 VIDEO. NO LICENSE IS GRANTED OR SHALL BE IMPLIED FOR ANY OTHER USE. ADDITIONAL INFORMATION INCLUDING THAT RELATING TO PROMOTIONAL, INTERNAL AND COMMERCIAL USES AND LICENSING MAY BE OBTAINED FROM MPEG LA, L.L.C. SEE [HTTP://WWW.MPEGLA.COM](http://www.mpegla.com).
- THIS PRODUCT IS LICENSED UNDER THE VC-1 PATENT PORTFOLIO LICENSE FOR THE PERSONAL AND NON-COMMERCIAL USE OF A CONSUMER TO (i) ENCODE VIDEO IN COMPLIANCE WITH THE VC-1 STANDARD ("VC-1 VIDEO") AND/OR (ii) DECODE VC-1 VIDEO THAT WAS ENCODED BY A CONSUMER ENGAGED IN A PERSONAL AND NON-COMMERCIAL ACTIVITY AND/OR WAS OBTAINED FROM A VIDEO PROVIDER LICENSED TO PROVIDE VC-1 VIDEO. NO LICENSE IS GRANTED OR SHALL BE IMPLIED FOR ANY OTHER USE. ADDITIONAL INFORMATION MAY BE OBTAINED FROM MPEG LA, L.L.C. SEE [HTTP://WWW.MPEGLA.COM](http://www.mpegla.com)
- libFLAC  
Copyright (C) 2000,2001,2002,2003,2004,2005,2006,2007,2008,2009 Josh Coalson  
Redistribution and use in source and binary forms, with or without modification, are permitted provided that the following conditions are met:
  - Redistributions of source code must retain the above copyright notice, this list of conditions and the following disclaimer.
  - Redistributions in binary form must reproduce the above copyright notice, this list of conditions and the following disclaimer in the documentation and/or other materials provided with the distribution.
  - Neither the name of the Xiph.org Foundation nor the names of its contributors may be used to endorse or promote products derived from this software without specific prior written permission.

THIS SOFTWARE IS PROVIDED BY THE COPYRIGHT HOLDERS AND CONTRIBUTORS "AS IS" AND ANY EXPRESS OR IMPLIED WARRANTIES, INCLUDING, BUT NOT LIMITED TO, THE IMPLIED WARRANTIES OF MERCHANTABILITY AND FITNESS FOR A PARTICULAR PURPOSE ARE DISCLAIMED. IN NO EVENT SHALL THE FOUNDATION OR CONTRIBUTORS BE LIABLE FOR ANY DIRECT, INDIRECT, INCIDENTAL, SPECIAL, EXEMPLARY, OR CONSEQUENTIAL DAMAGES (INCLUDING, BUT NOT LIMITED TO, PROCUREMENT OF SUBSTITUTE GOODS OR SERVICES; LOSS OF USE, DATA, OR PROFITS; OR BUSINESS INTERRUPTION) HOWEVER CAUSED AND ON ANY THEORY OF LIABILITY, WHETHER IN CONTRACT, STRICT LIABILITY, OR TORT (INCLUDING NEGLIGENCE OR OTHERWISE) ARISING IN ANY WAY OUT OF THE USE OF THIS SOFTWARE, EVEN IF ADVISED OF THE POSSIBILITY OF SUCH DAMAGE.
- libvorbis  
Copyright (c) 2002-2008 Xiph.org Foundation

Redistribution and use in source and binary forms, with or without modification, are permitted provided that the following conditions are met:

- Redistributions of source code must retain the above copyright notice, this list of conditions and the following disclaimer.
- Redistributions in binary form must reproduce the above copyright notice, this list of conditions and the following disclaimer in the documentation and/or other materials provided with the distribution.
- Neither the name of the Xiph.org Foundation nor the names of its contributors may be used to endorse or promote products derived from this software without specific prior written permission.

THIS SOFTWARE IS PROVIDED BY THE COPYRIGHT HOLDERS AND CONTRIBUTORS "AS IS" AND ANY EXPRESS OR IMPLIED WARRANTIES, INCLUDING, BUT NOT LIMITED TO, THE IMPLIED WARRANTIES OF MERCHANTABILITY AND FITNESS FOR A PARTICULAR PURPOSE ARE DISCLAIMED. IN NO EVENT SHALL THE FOUNDATION OR CONTRIBUTORS BE LIABLE FOR ANY DIRECT, INDIRECT, INCIDENTAL, SPECIAL, EXEMPLARY, OR CONSEQUENTIAL DAMAGES (INCLUDING, BUT NOT LIMITED TO, PROCUREMENT OF SUBSTITUTE GOODS OR SERVICES; LOSS OF USE, DATA, OR PROFITS; OR BUSINESS INTERRUPTION) HOWEVER CAUSED AND ON ANY THEORY OF LIABILITY, WHETHER IN CONTRACT, STRICT LIABILITY, OR TORT (INCLUDING NEGLIGENCE OR OTHERWISE) ARISING IN ANY WAY OUT OF THE USE OF THIS SOFTWARE, EVEN IF ADVISED OF THE POSSIBILITY OF SUCH DAMAGE.

- libogg  
Copyright (c) 2002, Xiph.org Foundation  
Redistribution and use in source and binary forms, with or without modification, are permitted provided that the following conditions are met:
  - Redistributions of source code must retain the above copyright notice, this list of conditions and the following disclaimer.
  - Redistributions in binary form must reproduce the above copyright notice, this list of conditions and the following disclaimer in the documentation and/or other materials provided with the distribution.
  - Neither the name of the Xiph.org Foundation nor the names of its contributors may be used to endorse or promote products derived from this software without specific prior written permission.

THIS SOFTWARE IS PROVIDED BY THE COPYRIGHT HOLDERS AND CONTRIBUTORS "AS IS" AND ANY EXPRESS OR IMPLIED WARRANTIES, INCLUDING, BUT NOT LIMITED TO, THE IMPLIED WARRANTIES OF MERCHANTABILITY AND FITNESS FOR A PARTICULAR PURPOSE ARE DISCLAIMED. IN NO EVENT SHALL THE FOUNDATION OR CONTRIBUTORS BE LIABLE FOR ANY DIRECT, INDIRECT, INCIDENTAL, SPECIAL, EXEMPLARY, OR CONSEQUENTIAL DAMAGES (INCLUDING, BUT NOT LIMITED TO, PROCUREMENT OF SUBSTITUTE GOODS OR SERVICES; LOSS OF USE, DATA, OR PROFITS; OR BUSINESS INTERRUPTION) HOWEVER CAUSED AND ON ANY THEORY OF LIABILITY, WHETHER IN CONTRACT, STRICT LIABILITY, OR TORT (INCLUDING NEGLIGENCE OR OTHERWISE) ARISING IN ANY WAY OUT OF THE USE OF THIS SOFTWARE, EVEN IF ADVISED OF THE POSSIBILITY OF SUCH DAMAGE.

## ■ FCC CAUTION

Changes or modifications not expressly approved by the party responsible for compliance could void the user's authority to operate the equipment.

### NOTE

- This equipment has been tested and found to comply with the limits for a Class B digital device, pursuant to Part 15 of the FCC Rules. These limits are designed to provide reasonable protection against harmful interference in a residential installation.
- This equipment generates, used and can radiate radio frequency energy and, if not installed and used in accordance with the instructions, may cause harmful interference to radio communications. However, there is no guarantee that interference will not occur in a particular installation. If this equipment does cause harmful interference to radio or television reception, which can be determined by turning the equipment off and on, the user is encouraged to try to correct the interference by one or more of the following measures:
  - Reorient or relocate the receiving antenna.
  - Increase the separation between the equipment and receiver.
  - Connect the equipment into an outlet on a circuit different from that to which the receiver is connected.
  - Consult the dealer or an experienced radio/TV technician for help.

This transmitter must not be co-located or operated in conjunction with any other antenna or transmitter.

## ■ IC (Industry Canada) Caution

This device contains licence-exempt transmitter(s)/ receiver(s) that comply with Innovation, Science and Economic Development Canada's licence-exempt RSS(s).

Operation is subject to the following two conditions:

- (1) This device may not cause interference.
- (2) This device must accept any interference, including interference that may cause undesired operation of the device.

## ▲ CAUTION

This equipment complies with FCC/IC radiation exposure limits set forth for an uncontrolled environment and meets the FCC radio frequency (RF) Exposure Guidelines and RSS-102 of the IC radio frequency (RF) Exposure rules. This equipment should be installed and operated keeping the radiator at least 20cm or more away from person's body.

## ■ Attention de l'IC (Industrie Canada)

L'émetteur/récepteur exempt de licence contenu dans le présent appareil est conforme aux CNR d'Innovation, Sciences et Développement économique Canada applicables aux appareils radio exempts de licence. L'exploitation est autorisée aux deux conditions suivantes :

- (1) L'appareil ne doit pas produire de brouillage.
- (2) L'appareil doit accepter tout brouillage radioélectrique subi, même si le brouillage est susceptible d'en compromettre le fonctionnement.

## ▲ ATTENTION

Cet équipement est conforme aux limites d'exposition aux rayonnements énoncées pour un environnement non contrôlé et respecte les règles des radioélectriques (RF) de la FCC lignes directrices d'exposition et d'exposition aux fréquences radioélectriques (RF) CNR-102 de l'IC. Cet équipement doit être installé et utilisé en gardant une distance de 20 cm ou plus entre le radiateur et le corps humain.

### Supplier's Declaration of Conformity

Trade Name: JVC  
Products: MONITOR WITH RECEIVER  
Model Name: KW-M560BT / KW-M56BT  
Responsible Party: JVCKENWOOD USA  
CORPORATION  
2201 East Dominguez Street,  
Long Beach, CA 90810, U.S.A.  
PHONE: 310 639-9000

THIS DEVICE COMPLIES WITH PART 15 OF THE FCC RULES. OPERATION IS SUBJECT TO THE FOLLOWING TWO CONDITIONS:

- (1) THIS DEVICE MAY NOT CAUSE HARMFUL INTERFERENCE, AND
- (2) THIS DEVICE MUST ACCEPT ANY INTERFERENCE RECEIVED, INCLUDING INTERFERENCE THAT MAY CAUSE UNDESIRE OPERATION.

### ■ Información acerca de la eliminación de equipos eléctricos y electrónicos al final de la vida útil (aplicable a los países que hayan adoptado sistemas independientes de recogida de residuos)



Los productos con el símbolo de un contenedor con ruedas tachado no podrán ser desechados como residuos domésticos.

Los equipos eléctricos y electrónicos al final de la vida útil, deberán ser reciclados en instalaciones que puedan dar el tratamiento adecuado a estos productos y a sus subproductos residuales correspondientes. Póngase en contacto con su administración local para obtener información sobre el punto de recogida más cercano. Un tratamiento correcto del reciclaje y la eliminación de residuos ayuda a conservar los recursos y evita al mismo tiempo efectos perjudiciales en la salud y el medio ambiente.

### ■ Informação sobre a eliminação de pilhas

Este produto não deve ser eliminado como lixo doméstico geral. Devolva a pilha usada ao revendedor ou entidade autorizada para que a mesma seja devolvida ao fabricante ou importador.

A reciclagem e a eliminação de lixo de maneira apropriada ajudarão a conservar os recursos naturais ao mesmo tempo que prevenirão os efeitos prejudiciais à nossa saúde e ao meio ambiente.

### ■ Para cumplimiento de la IFT:

“La operación de este equipo esta sujeta a las siguientes dos condiciones:

- (1) es posible que este equipo o dispositivo no cause interferencia perjudicial y
- (2) este equipo o dispositivo debe aceptar cualquier interferencia, incluyendo la que pueda causar su operación no deseada.”

**JVC**

130.com.ua



**android**  
auto