



PHONES

0 (800) 800 130  
(050) 462 0 130  
(063) 462 0 130  
(067) 462 0 130

130  
COM.UA

Internet store of  
autogoods



SKYPE

km-130

CAR RECEIVERS — Receivers • Media receivers and stations • Native receivers • CD/DVD changers • FM-modulators/USB adapters • Flash memory • Facia plates and adapters • Antennas • Accessories |  
CAR AUDIO — Car audio speakers • Amplifiers • Subwoofers • Processors • Crossovers • Headphones • Accessories | TRIP COMPUTERS — Universal computers • Model computers • Accessories |  
GPS NAVIGATORS — Portable GPS • Built-in GPS • GPS modules • GPS trackers • Antennas for GPS navigators • Accessories | VIDEO — DVR • TV sets and monitors • Car TV tuners • Cameras • Videomodules  
• Transcoders • Car TV antennas • Accessories | SECURITY SYSTEMS — Car alarms • Bike alarms • Mechanical blockers • Immobilizers • Sensors • Accessories | OPTIC AND LIGHT — Xenon • Bixenon • Lamps  
• LED • Stroboscopes • Optic and Headlights • Washers • Light, rain sensors • Accessories | PARKTRONICS AND MIRRORS — Rear parktronic • Front parktronic • Combined parktronic • Rear-view mirrors  
• Accessories | HEATING AND COOLING — Seat heaters • Mirrors heaters • Screen-wipers heaters • Engine heaters • Auto-refrigerators • Air conditioning units • Accessories | TUNING — Vibro-isolation  
• Noise-isolation • Tint films • Accessories | ACCESSORIES — Radar-detectors • Handsfree, Bluetooth • Windowlifters • Compressors • Beeps, loudspeakers • Measuring instruments • Cleaners • Car seats  
• Miscellaneous | MOUNTING — Installation kits • Upholstery • Grilles • Tubes • Cable and wire • Tools • Miscellaneous | POWER — Batteries • Converters • Start-charging equipment • Capacitors  
• Accessories | MARINE AUDIO AND ELECTRONICS — Marine receivers • Marine audio speakers • Marine subwoofers • Marine amplifiers • Accessories | CAR CARE PRODUCTS — Additives • Washer fluid •  
Care accessories • Car polish • Flavors • Adhesives and sealants | LIQUID AND OIL — Motor oil • Transmission oil • Brake fluid • Antifreeze • Technical lubricant



In store "130" you can find and buy almost all necessary goods for your auto in Kyiv and other cities, delivery by ground and postal services. Our experienced consultants will provide you with exhaustive information and help you to chose the very particular thing. We are waiting for you at the address

<https://130.com.ua>



# INSTALLATION MANUAL

Club 34F

Club 44F

Club 54F

Club 64FSL

Club 644F

Club 864F

Club 964M

Club 64

Club 64SQ

Club 194T  
Autogoods "130"

Club 64CSQ

Club 64C

Club 64CTP

# Club 34F

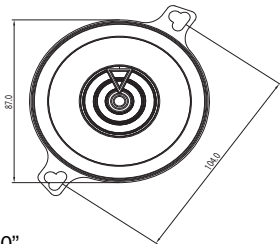
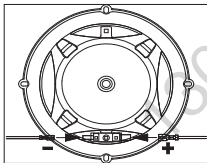
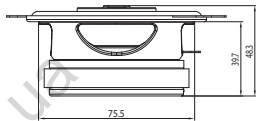

Autogoods "130"

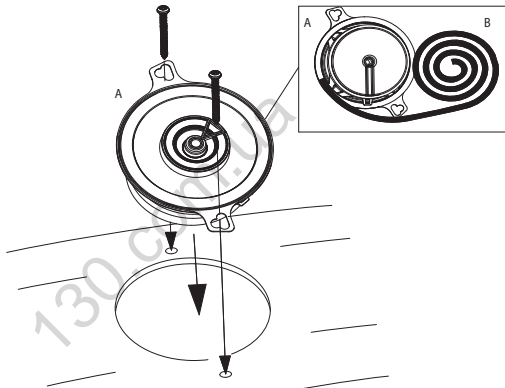
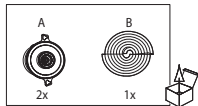

Autogoods "130"

## Specifications

- Type: 3-1/2" (87mm) Two-Way Car Speaker
- Power Handling: 25W RMS, 75W peak
- Sensitivity (@ 2.83V/m): 89dB
- Frequency Response: 90Hz – 20kHz
- Nominal Impedance: 3.0 ohms

## Thiele-Small Parameters

- BL (Tm): 2.873
- DCR (ohms): 2.26
- Mms (g): 3.723
- Sd (cm<sup>2</sup>): 44.18
- Cms (μm/N): 0.491
- Vas (l): 1.3574
- Fs (Hz): 117.7
- Qes: 0.755
- Qms: 7.777
- Qts: 0.688
- Crossover Point: 4kHz

Autogoods "130"

# Club 44F

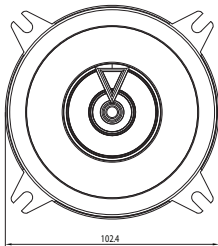
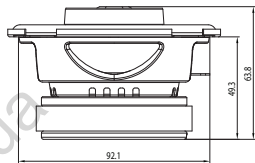
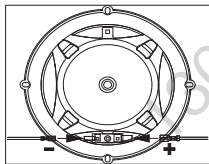

Autogoods "130"

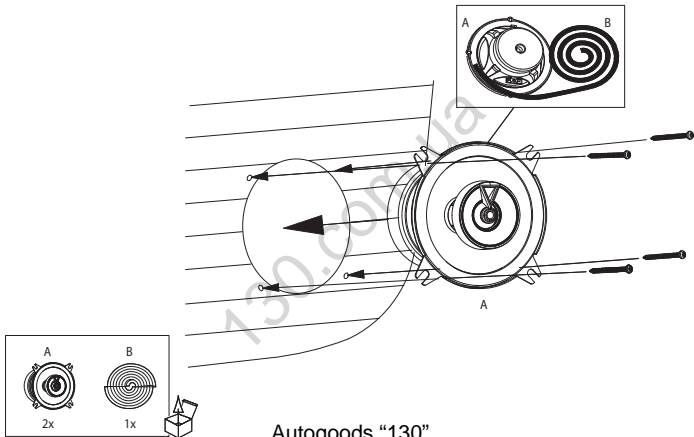

Autogoods "130"

## Specifications

- Type: 4" (100mm) Two-Way Car Speaker
- Power Handling: 35W RMS, 105W peak
- Sensitivity (@ 2.83V): 90dB
- Frequency Response: 75Hz – 20kHz
- Nominal Impedance: 3.0 ohms

## Thiele-Small Parameters

- BL (Tm): 3.783
- DCR (ohms): 2.46
- Mms (g): 6.608
- Sd (cm<sup>2</sup>): 63.62
- Cms (μm/N): 0.750
- Vas (l): 4.2937
- Fs (Hz): 71.5
- Qes: 0.510
- Qms: 6.495
- Qts: 0.473
- Crossover Point: 3kHz

Autogoods "130"



# Club 54F

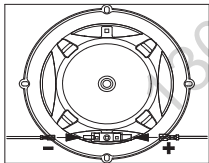
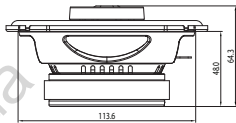

Autogoods "130"

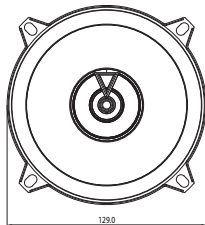

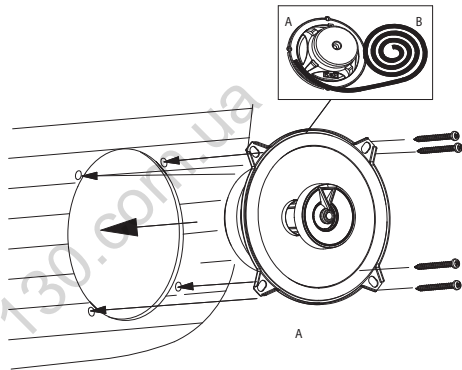
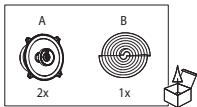

Autogoods "130"

## Specifications

- Type: 5-1/4" (130mm) Two-Way Car Speaker
- Power Handling: 45W RMS, 135W peak
- Sensitivity (@ 2.83V): 91dB
- Frequency Response: 75Hz – 20kHz
- Nominal Impedance: 3.0 ohms

## Thiele-Small Parameters

- BL (Tm): 3.563
- DCR (ohms): 2.24
- Mms (g): 9.484
- Sd (cm<sup>2</sup>): 103.87
- Cms (µm/N): 0.274
- Vas (l): 4.1850
- Fs (Hz): 98.7
- Qes: 1.036
- Qms: 8.608
- Qts: 0.925
- Crossover Point: 3kHz

Autogoods "130"

# Club 64FSL

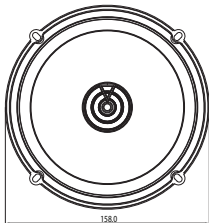
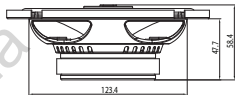
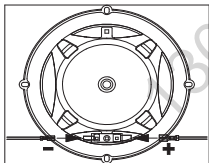

Autogoods "130"

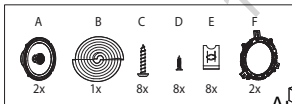
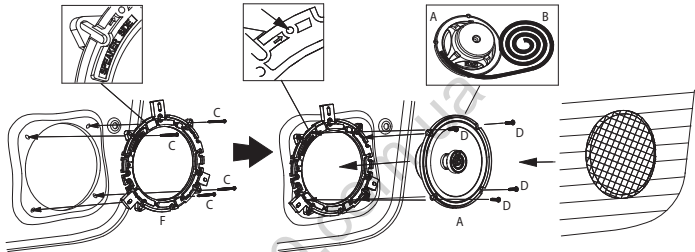

Autogoods "130"

## Specifications

- Type: Shallow-Mount 6-1/2" (160mm) Two-Way Car Speaker
- Power Handling: 55W RMS, 165W peak
- Sensitivity (@ 2.83V): 92dB
- Frequency Response: 55Hz – 20kHz
- Nominal Impedance: 3.0 ohms

## Thiele-Small Parameters

- BL (Tm): 3.739
- DCR (ohms): 2.41
- Mms (g): 9.934
- Sd (cm<sup>2</sup>): 122.72
- Cms (μm/N): 0.278
- Vas (l): 5.9287
- Fs (Hz): 95.7
- Qes: 1.032
- Qms: 11.357
- Qts: 0.946
- Crossover Point: 4kHz

Autogoods "130"

# Club 644F

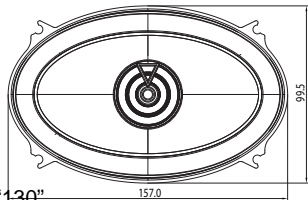
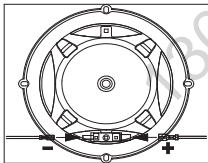
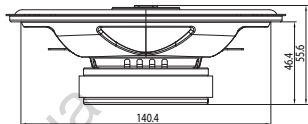

Autogoods "130"

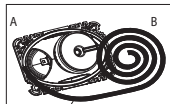
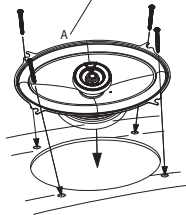
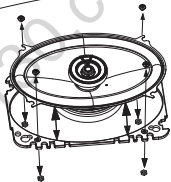
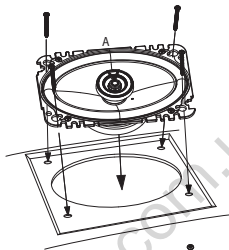
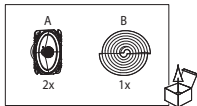

Autogoods "130"



## Specifications

- Type: 4"x 6" (100mm x 152mm) Two-Way Car Speaker
- Power Handling: 40W RMS, 120W peak
- Sensitivity (@ 2.83V): 92dB
- Frequency Response: 75Hz – 20kHz
- Nominal Impedance: 3.0 ohms

## Thiele-Small Parameters

- BL (Tm): 3.296
- DCR (ohms): 2.5
- Mms (g): 7.86
- Sd (cm<sup>2</sup>): 86.59
- Cms (μm/N): 0.245
- Vas (l): 2.5977
- Fs (Hz): 114.7
- Qes: 1.303
- Qms: 12.752
- Qts: 1.182
- Crossover Point: 3kHz

Autogoods "130"

# Club 864F

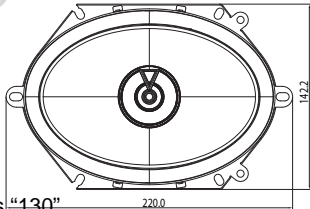
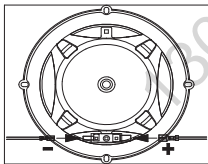
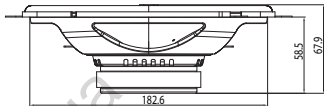

Autogoods "130"

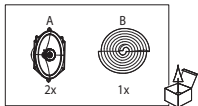
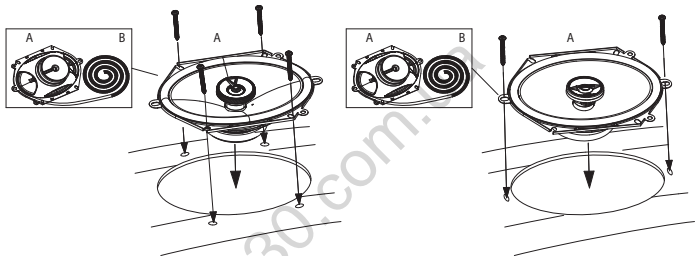

Autogoods "130"

## Specifications

- Type: 6"x8" (152mm x 203mm) two-way car speaker, no grille
- Power Handling: 60W RMS, 180W peak
- Sensitivity (@ 2.83V): 93dB
- Frequency Response: 65Hz – 20kHz
- Nominal Impedance: 3.0 ohms

## Thiele-Small Parameters

- BL (Tm): 3.785
- DCR (ohms): 2.39
- Mms (g): 17.718
- Sd (cm<sup>2</sup>): 165.13
- Cms (µm/N): 0.336
- Vas (l): 12.9798
- Fs (Hz): 65.2
- Qes: 1.210
- Qms: 14.592
- Qts: 1.118
- Crossover Point: 3.5kHz

Autogoods "130"

# Club 964M

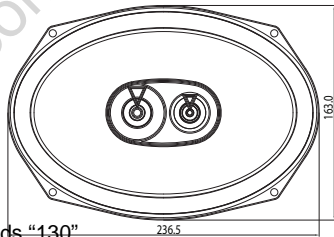
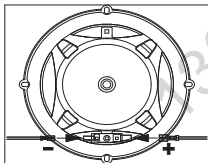
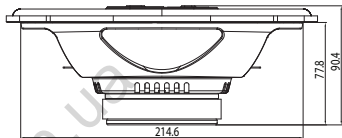

Autogoods "130"

236.5

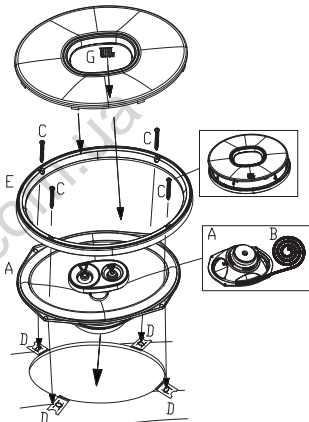
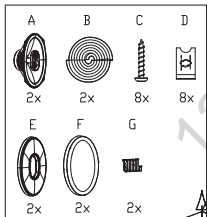

Autogoods "130"

## Specifications

- Type: 6"x9" (152mm x 230mm) three-way car speaker
- Power Handling: 85W RMS, 255W peak
- Sensitivity (@ 2.83V): 93dB
- Frequency Response: 50Hz – 20kHz
- Nominal Impedance: 3.0 ohms

## Thiele-Small Parameters

- BL (Tm): 4.063
- DCR (ohms): 2.63
- Mms (g): 23.163
- Sd (cm<sup>2</sup>): 226.98
- Cms (µm/N): 0.337
- Vas (l): 24.5866
- Fs (Hz): 56.9
- Qes: 1.321
- Qms: 11.751
- Qts: 1.188
- Crossover Point: 3kHz

Autogoods "130"

# Club 64

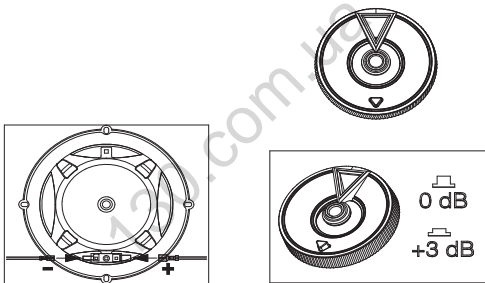

Autogoods "130"



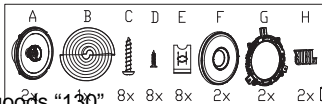
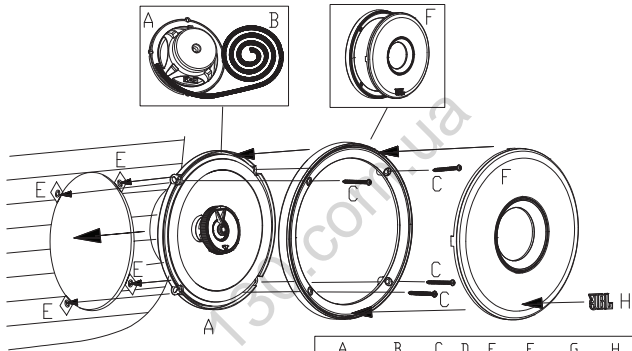

Autogoods "130"



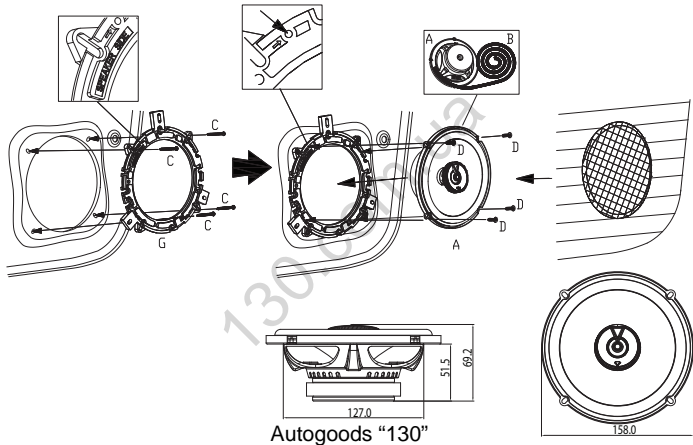

## Specifications

- Type: 6-1/2" (160mm) Two-way Car Speaker, Engineered For Better Sound Performance.
- Power Handling: 60W RMS, 180W peak
- Sensitivity (@ 2.83V): 93dB
- Frequency Response: 48Hz – 21kHz
- Nominal Impedance: 3.0 ohms

## Thiele-Small Parameters

- BL (Tm): 3.632
- DCR (ohms): 2.36
- Mms (g): 13.758
- Sd (cm<sup>2</sup>): 132.73
- Cms (μm/N): 0.378
- Vas (l): 9.4253
- Fs (Hz): 69.8
- Qes: 1.080
- Qms: 10.655
- Qts: 0.980
- Crossover Point: 3.5kHz

Autogoods "130"

# Club 64SQ

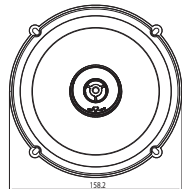
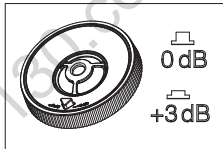
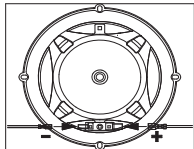
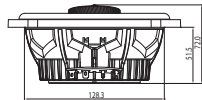

Autogoods "130"

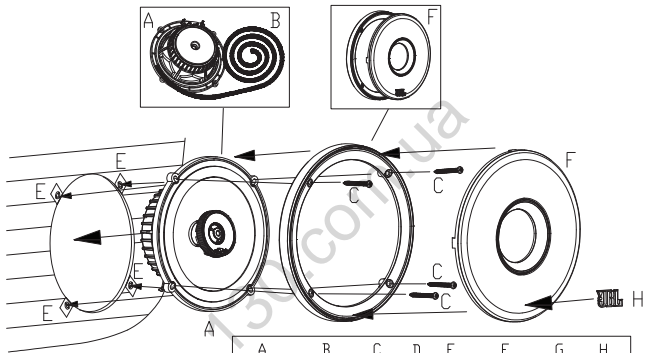

A	B	C	D	E	F	G	H
2x	1x	8x	8x	8x	2x	2x	2x

Autogoods 130



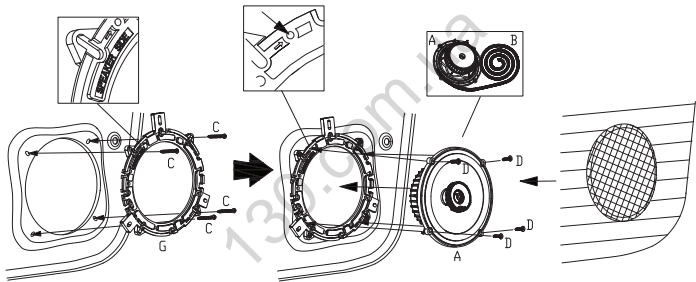

Autogoods "130"

## Specifications

- Type: 6-1/2" (160mm) 2-way Car Speaker, Engineered For Ultimate Sound Quality.
- Power Handling: 75W RMS, 225W peak
- Sensitivity (@ 2.83V): 93dB
- Frequency Response: 48Hz – 21kHz
- Nominal Impedance: 3.0 ohms

## Thiele-Small Parameters

- BL (Tm): 3.748
- DCR (ohms): 2.12
- Mms (g): 12.273
- Sd (cm<sup>2</sup>): 132.73
- Cms (μm/N): 0.530
- Vas (l): 13.2162
- Fs (Hz): 62.4
- Qes: 0.724
- Qms: 9.037
- Qts: 0.671
- Crossover Point: 5 kHz

Autogoods "130"

# Club 194T

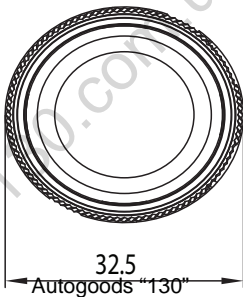
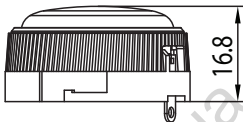



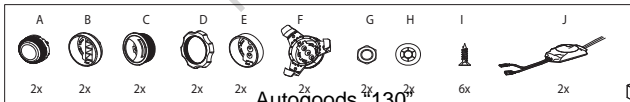
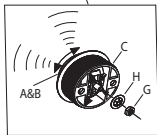
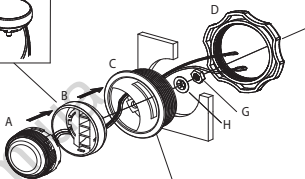
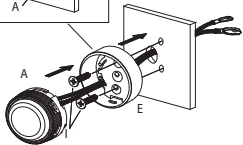
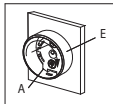

Autogoods 130



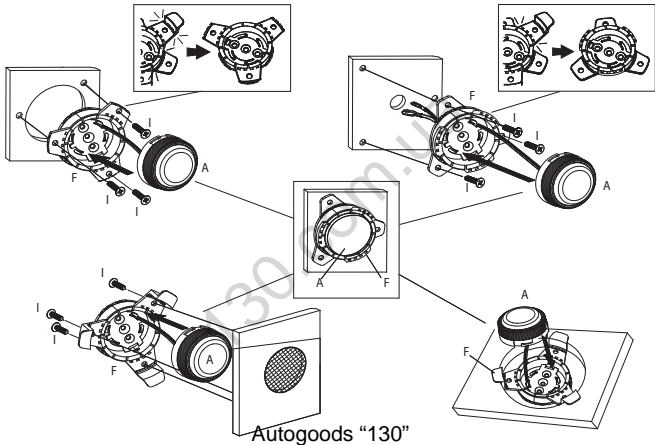

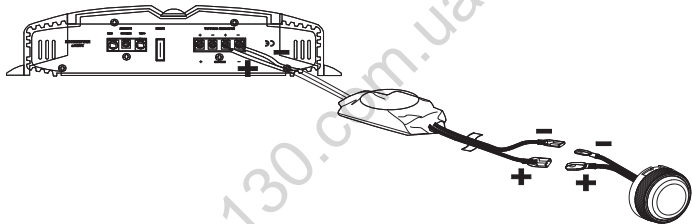

Autogoods "130"

## Specifications

- Type: 3/4" (19mm) Edge-Driven dome tweeter
- Power Handling: 50W RMS, 150W peak
- Sensitivity (@ 2.83V): 92dB
- Frequency Response: 3kHz – 20kHz
- Nominal Impedance: 3.0 ohms

130.com.ua

Autogoods "130"

# Club 64CSQ

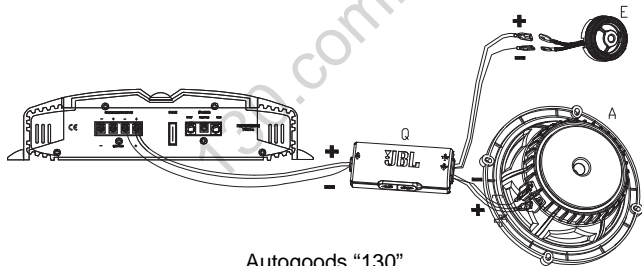
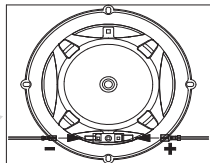

Autogoods "130"

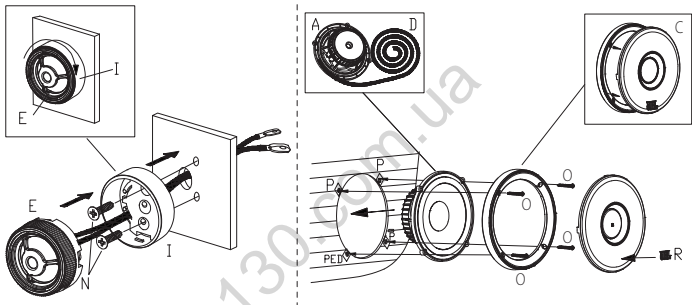

Autogoods "130"

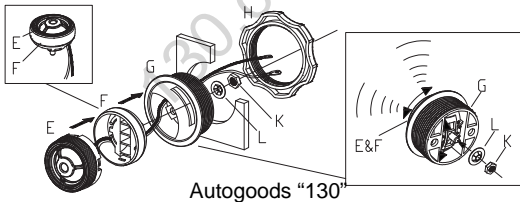
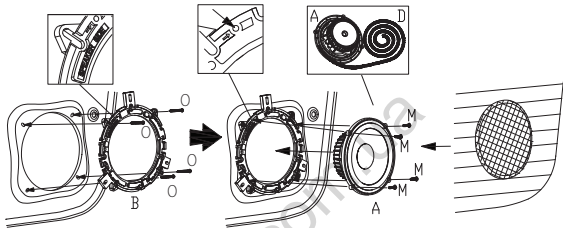

Autogoods "130"

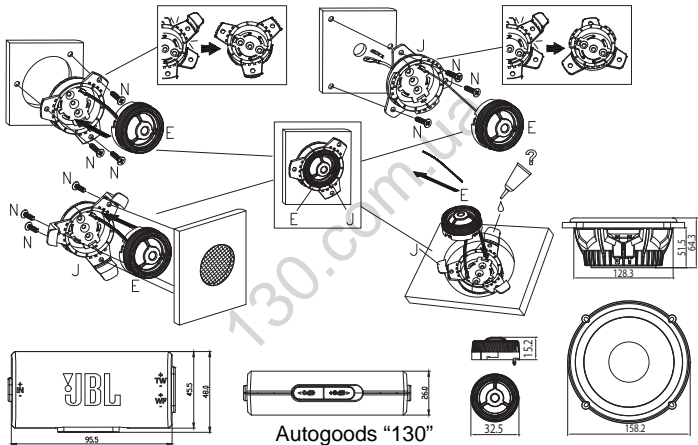



## Specifications

- Type: 6-1/2" (160mm) 2-way Component Speaker System, Engineered For Ultimate Sound Quality.
- Power Handling: 95W RMS, 285W peak
- Sensitivity (@ 2.83V): 93dB
- Frequency Response: 48Hz – 21kHz
- Nominal Impedance: 3.0 ohms

## Thiele-Small Parameters

- BL (Tm): 3.776
- DCR (ohms): 2.09
- Mms (g): 13.238
- Sd (cm<sup>2</sup>): 132.73
- Cms (μm/N): 0.536
- Vas (l): 13.3648
- Fs (Hz): 59.7
- Qes: 0.728
- Qms: 8.315
- Qts: 0.670
- Crossover Point: 5 kHz

Autogoods "130"

# Club 64C

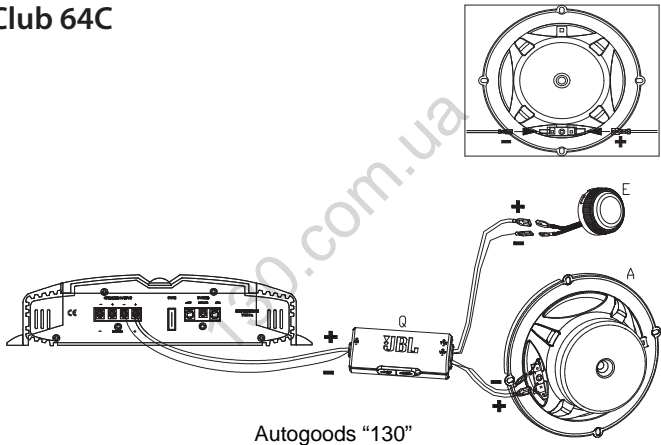

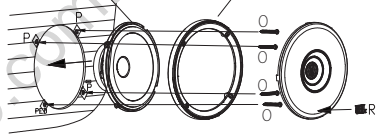
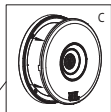
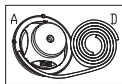
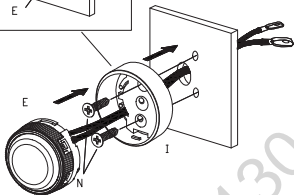
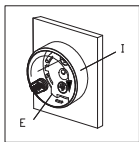

Autogoods 130



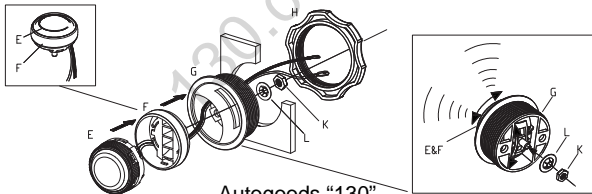
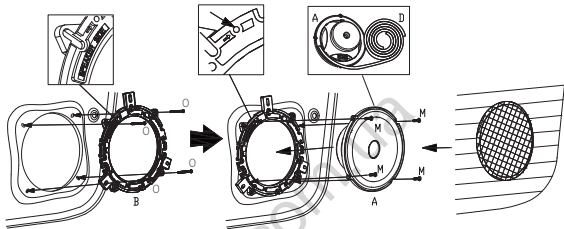

Autogoods "130"

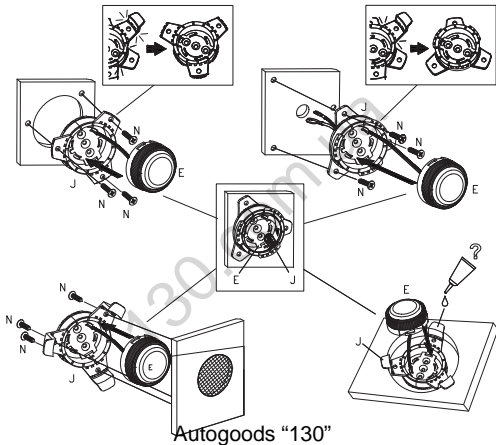

Autogoods "130"

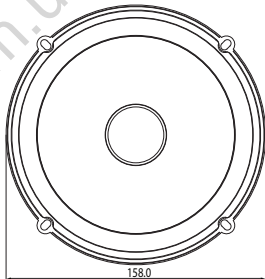
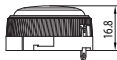
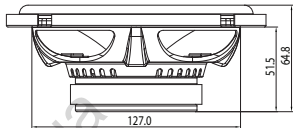
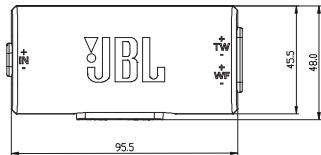

Autogoods "130"

## Specifications

- Type: 6-1/2" (160mm) Two-Way Component Speaker System
- Power Handling: 70W RMS, 210W peak
- Sensitivity (@ 2.83V): 92dB
- Frequency Response: 55Hz – 20kHz
- Nominal Impedance: 3.0 ohms

## Thiele-Small Parameters

- BL (Tm): 3.635
- DCR (ohms): 2.37
- Mms (g): 14.409
- Sd (cm<sup>2</sup>): 132.73
- Cms (μm/N): 0.257
- Vas (l): 6.4107
- Fs (Hz): 82.7
- Qes: 1.340
- Qms: 10.965
- Qts: 1.194
- Crossover Point: 5.5kHz

Autogoods "130"

# Club 64CTP

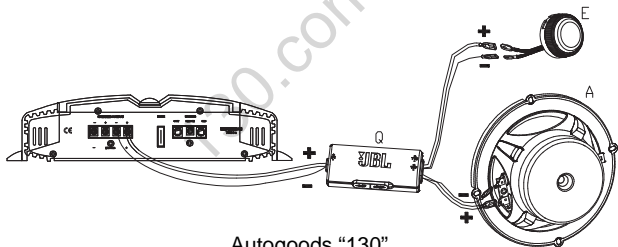
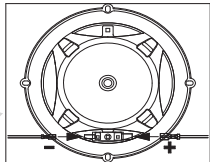

Autogoods "130"



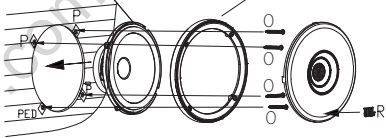
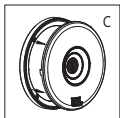
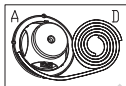
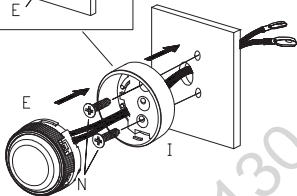
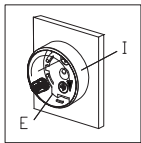

130.com.ua

A	B	C	D	E	F	G	H	I	J	K	L	M	N	O	P	Q	R	S	T	U	V	W	X	Y	Z
2x	2x	2x	1x	2x	2x	2x	2x	2x	2x	2x	2x	8x	6x	8x	8x	2x	8x	2x	2x	2x	2x	2x	4x	2x	2x

Autogoods "130"



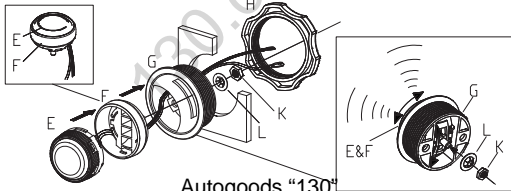
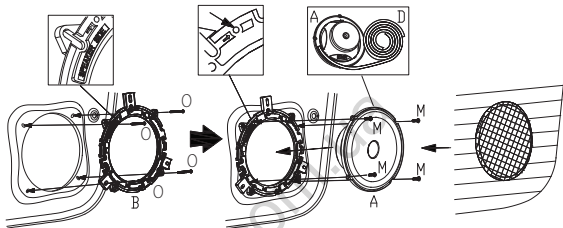

Autogoods "130"

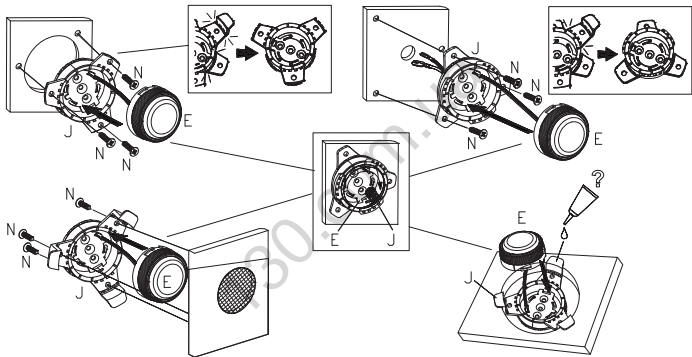

Autogoods "130"

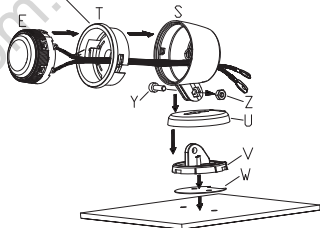
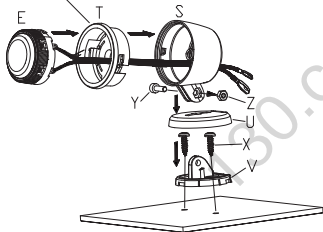

Autogoods "130"

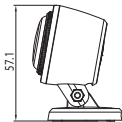
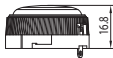
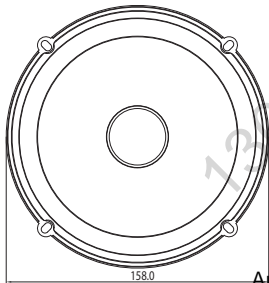
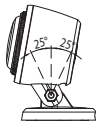
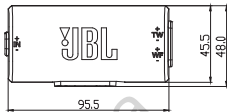
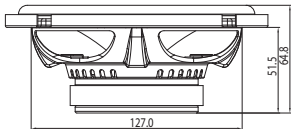

Autogoods "130

## Specifications

- Type: 6-1/2" (160mm) Two-Way Component Speaker System with Tweeter Pod
- Power Handling: 70W RMS, 210W peak
- Sensitivity (@ 2.83V): 92dB
- Frequency Response: 55Hz – 20kHz
- Nominal Impedance: 3.0 ohms

## Thiele-Small Parameters

- BL (Tm): 3.635
- DCR (ohms): 2.37
- Mms (g): 14.409
- Sd (cm<sup>2</sup>): 132.73
- Cms (μm/N): 0.257
- Vas (l): 6.4107
- Fs (Hz): 82.7
- Qes: 1.340
- Qms: 10.965
- Qts: 1.194
- Crossover Point: 5.5kHz

Autogoods "130"



HARMAN International  
Industries, Incorporated, 8500  
Balboa Boulevard, Northridge,  
CA 91329 USA

© 2023 HARMAN International  
Industries, Incorporated.

All rights reserved. JBL is a  
trademark of HARMAN International Industries, Incorporated,  
registered in the United States and/or other countries.  
Features, specifications and appearance are subject to change  
without notice.

**Autogoods "130"**