



PHONES

0 (800) 800 130
(050) 462 0 130
(063) 462 0 130
(067) 462 0 130

130
COM.UA

Internet store of
autogoods



SKYPE

km-130

CAR RECEIVERS — Receivers • Media receivers and stations • Native receivers • CD/DVD changers • FM-modulators/USB adapters • Flash memory • Facia plates and adapters • Antennas • Accessories |
 CAR AUDIO — Car audio speakers • Amplifiers • Subwoofers • Processors • Crossovers • Headphones • Accessories | TRIP COMPUTERS — Universal computers • Model computers • Accessories |
 GPS NAVIGATORS — Portable GPS • Built-in GPS • GPS modules • GPS trackers • Antennas for GPS navigators • Accessories | VIDEO — DVR • TV sets and monitors • Car TV tuners • Cameras • Videomodules
 • Transcoders • Car TV antennas • Accessories | SECURITY SYSTEMS — Car alarms • Bike alarms • Mechanical blockers • Immobilizers • Sensors • Accessories | OPTIC AND LIGHT — Xenon • Bixenon • Lamps
 • LED • Stroboscopes • Optic and Headlights • Washers • Light, rain sensors • Accessories | PARKTRONICS AND MIRRORS — Rear parktronic • Front parktronic • Combined parktronic • Rear-view mirrors
 • Accessories | HEATING AND COOLING — Seat heaters • Mirrors heaters • Screen-wipers heaters • Engine heaters • Auto-refrigerators • Air conditioning units • Accessories | TUNING — Vibro-isolation
 • Noise-isolation • Tint films • Accessories | ACCESSORIES — Radar-detectors • Handsfree, Bluetooth • Windowlifters • Compressors • Beeps, loudspeakers • Measuring instruments • Cleaners • Car seats
 • Miscellaneous | MOUNTING — Installation kits • Upholstery • Grilles • Tubes • Cable and wire • Tools • Miscellaneous | POWER — Batteries • Converters • Start-charging equipment • Capacitors
 • Accessories | MARINE AUDIO AND ELECTRONICS — Marine receivers • Marine audio speakers • Marine subwoofers • Marine amplifiers • Accessories | CAR CARE PRODUCTS — Additives • Washer fluid •
 Care accessories • Car polish • Flavors • Adhesives and sealants | LIQUID AND OIL — Motor oil • Transmission oil • Brake fluid • Antifreeze • Technical lubricant



In store "130" you can find and buy almost all necessary goods for your auto in Kyiv and other cities, delivery by ground and postal services. Our experienced consultants will provide you with exhaustive information and help you to choose the very particular thing. We are waiting for you at the address

<https://130.com.ua>

130.com.ua

Operator's manual

Portable Generators
G1300P G2500P G3200P
G5500P G8500P



English

Please read the operator's manual carefully and make sure you understand the instructions before using the machine.

DEADLY EXHAUST FUMES! ONLY use OUTDOOR far away from windows, doors and vents!
NOT INTENDED FOR USE IN CRITICAL LIFE SUPPORT APPLICATIONS.
SAVE this Manual. Provide this manual to any operator of the generator.

Contents

INTRODUCTION	4
INTRODUCTION	4
SAFETY RULES	4
GENERAL HAZARDS	5
EXHAUST & LOCATION HAZARDS	6
ELECTRICAL HAZARDS	6
FIRE HAZARDS	7
KEY TO SYMBOLS	8
1. GENERAL INFORMATION	9
1.1 UNPACKING	9
1.1.1 ACCESSORY (5500 & 8500)	9
1.2 ASSEMBLY	9
1.2.1 ASSEMBLING THE ACCESSORY KIT (5500 & 8500)	10
2. OPERATION	10
2.1 KNOW THE GENERATOR	10
2.2 CORD SETS AND CONNECTION PLUGS	11
2.3 HOW TO USE THE GENERATOR	13
2.3.1 GROUNDING THE GENERATOR WHEN USED AS A PORTABLE	13
2.3.2 CONNECTING THE GENERATOR TO A BUILDING'S ELECTRICAL SYSTEM	14
2.3.3 CONNECTING ELECTRICAL LOADS	14
2.4 DON'T OVERLOAD THE GENERATOR	14
2.5 WATTAGE REFERENCE GUIDE	15
2.6 BEFORE STARTING THE GENERATOR	16
2.6.1 ADDING ENGINE OIL	16
2.6.2 ADDING GASOLINE	17
2.7 TO START THE ENGINE	18
2.9 LOW OIL LEVEL SHUTDOWN SYSTEM	18
2.9.1 SENSING LOW OIL LEVEL	18

3. MAINTENANCE	19
3.1 MAINTENANCE SCHEDULE.....	19
3.2 PRODUCT SPECIFICATIONS.....	19
3.2.1 GENERATOR SPECIFICATIONS	19
3.3 GENERAL RECOMMENDATIONS	20
3.3.1 GENERATOR MAINTENANCE	20
3.3.2 TO CLEAN THE GENERATOR	20
3.3.3 ENGINE MAINTENANCE	21
3.3.4 CHECKING OIL LEVEL	21
3.3.5 CHANGING THE OIL.....	21
3.3.6 REPLACING THE SPARK PLUG	22
3.3.7 SPARK ARRESTOR	22
3.4 SERVICE AIR FILTER.....	23
3.5 GENERAL	23
3.6 LONG TERM STORAGE.....	23
3.7 OTHER STORAGE TIPS	24
4. TROUBLESHOOTING	25
4.1 TROUBLESHOOTING GUIDE.....	25
5. EC DECLARATION OF CONFORMITY	27
5.1 EC DECLARATION OF CONFORMITY FOR THE FOLLWING MACHINERY:.....	27

INTRODUCTION

INTRODUCTION

Thank you for purchasing this model by Husqvarna AB.

The models are compact, high performance, air-cooled, engine driven generators designed to supply electrical power to operate electrical loads where no utility power is available or in place of utility due to a power outage.

READ THIS MANUAL THOROUGHLY

If any portion of this manual is not understood, contact the nearest Authorized Dealer for starting, operating and servicing procedures.

The operator is responsible for proper and safe use of the equipment. We strongly recommend that the operator read this manual and thoroughly understand all instructions before using the equipment. We also strongly recommend instructing other users to properly start and operate the unit. This prepares them if they need to operate the equipment in an emergency.

The generator can operate safely, efficiently and reliably only if it is properly located, operated and maintained. Before operating or servicing the generator:

- Become familiar with and strictly adhere to all local, state and national codes and regulations.
- Study all safety warnings in this manual and on the product carefully.
- Become familiar with this manual and the unit before use.

HUSQVARNA AB RESERVE THE RIGHT TO MODIFY THIS MANUAL AT ANY TIME.

SAFETY RULES

Throughout this publication, and on tags and decals affixed to the generator, DANGER, WARNING, CAUTION and NOTE blocks are used to alert personnel to special instructions about a particular operation that may be hazardous if performed incorrectly or carelessly. Observe them carefully. Their definitions are as follows:

 **DANGER:**
INDICATES A HAZARDOUS SITUATION OR ACTION WHICH, IF NOT AVOIDED, WILL RESULT IN DEATH OR SERIOUS INJURY.

 **WARNING:**
Indicates a hazardous situation or action which, if not avoided, could result in death or serious injury.

 **CAUTION:** Indicates a hazardous situation or action which, if not avoided, could result in minor or moderate injury.

NOTE:

Notes contain additional information important to a procedure and will be found within the regular text body of this manual.

These safety warnings cannot eliminate the hazards that they indicate. Common sense and strict compliance with the special instructions while performing the action or service are essential to preventing accidents.

Four commonly used safety symbols accompany the **DANGER**, **WARNING** and **CAUTION** blocks. The type of information each indicates is as follows:

 This symbol points out important safety information that, if not followed, could endanger personal safety and/or property of others.

 This symbol points out contain poisonous exhaust.

 This symbol points out potential fire or explosion hazard.

 This symbol points out potential electrical shock hazard.

 This symbol points out keep the generator away from rain or snow, NEVER keep it in moisture places.

GENERAL HAZARDS

- NEVER operate in an enclosed area, in a vehicle, or indoors EVEN IF doors and windows are open.
- For safety reasons, the manufacturer recommends that the maintenance of this equipment is carried out by an Authorized Dealer. Inspect the generator regularly, and contact the nearest Authorized Dealer for parts needing repair or replacement.
- Operate generator only on level surfaces and where it will not be exposed to excessive moisture, dirt, dust or corrosive vapors.
- Keep hands, feet, clothing, etc., away from drive belts, fans, and other moving parts. Never remove any fan guard or shield while the unit is operating.
- Certain parts of the generator get extremely hot during operation. Keep clear of the generator until it has cooled to avoid severe burns.
- Do NOT operate generator in the rain.
- Do not alter the construction of the generator or change controls which might create an unsafe operating condition.
- Never start or stop the unit with electrical loads connected to receptacles AND with connected devices turned ON. Start the engine and let it stabilize before connecting electrical loads. Disconnect all electrical loads before shutting down the generator.
- Do not insert objects through unit's cooling slots.
- When working on this equipment, remain alert at all times. Never work on the equipment when physically or mentally fatigued.
- Never use the generator or any of its parts as a step. Stepping on the unit can stress and break parts, and may result in dangerous operating conditions from leaking exhaust gases, fuel leakage, oil leakage, etc.

NOTE: This generator is equipped with a spark arrestor muffler. The spark arrestor must be maintained in effective working order by the owner/operator.

EXHAUST & LOCATION HAZARDS

- Never operate in an enclosed area or indoors! NEVER use in the home, in a vehicle, or in partly enclosed areas such as garages, EVEN IF doors and windows are open! ONLY use outdoors and far from open windows, doors, vents, and in an area that will not accumulate deadly exhaust.

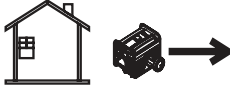
⚠ DANGER	
Using a generator indoors CAN KILL YOU IN MINUTES.	
Generator exhaust contains carbon monoxide. This is a poison you cannot see or smell.	
 NEVER use inside a home or garage, EVEN IF doors and windows are open.	 Only use OUTSIDE and far away from windows, doors, and vents.

- The engine exhaust fumes contain carbon monoxide, which you cannot see or smell. This poisonous gas, if breathed in sufficient concentrations, can cause unconsciousness or even death.
- Adequate, unobstructed flow of cooling and ventilating air is critical to correct generator operation. Do not alter the installation or permit even partial blockage of ventilation provisions, as this can seriously affect safe operation of the generator. The generator MUST be operated outdoors.
- This exhaust system must be properly maintained. Do nothing that might render the exhaust system unsafe or in noncompliance with any local codes and/or standards.
- Always use a battery operated carbon monoxide alarm indoors, installed according to the manufacturers instructions.
- If you start to feel sick, dizzy, or weak after the generator has been running, move to fresh air IMMEDIATELY. See a doctor, as you could have carbon monoxide poisoning.

ELECTRICAL HAZARDS

- The generator produces dangerously high voltage when in operation. Avoid contact with bare wires, terminals, connections, etc., while the unit is running, even on equipment connected to the generator. Ensure all appropriate covers, guards and barriers are in place before operating the generator.
- Never handle any kind of electrical cord or device while standing in water, while bare-foot or while hands or feet are wet. DANGEROUS ELECTRICAL SHOCK MAY RESULT.
- Some countries may require the frame and external electrically conductive parts of the generator be properly connected to an approved earth ground. May also require proper grounding of the generator. Consult with a local electrician for grounding requirements in the area.
- Use a ground fault circuit interrupter in any damp or highly conductive area (such as metal decking or steel work).

- Do not use worn, bare, frayed or otherwise damaged electrical cord sets with the generator.
- Before performing any maintenance on the generator, disconnect the engine starting battery (if equipped) to prevent accidental start up. Disconnect the cable from the battery post indicated by a NEGATIVE, NEG or (-) first. Reconnect that cable last.
- In case of accident caused by electric shock, immediately shut down the source of electrical power. If this is not possible, attempt to free the victim from the live conductor. AVOID DIRECT CONTACT WITH THE VICTIM. Use a non-conducting implement, such as a rope or board, to free the victim from the live conductor. If the victim is unconscious, apply first aid and get immediate medical help.

FIRE HAZARDS

- Gasoline is highly FLAMMABLE and its vapors are EXPLOSIVE. Do not permit smoking, open flames, sparks or heat in the vicinity while handling gasoline.
- Never add fuel while unit is running or hot. Allow engine to cool completely before adding fuel.
- Never fill fuel tank indoors. Comply with all laws regulating storage and handling of gasoline.
- Do not overfill the fuel tank. Always allow room for fuel expansion. If tank is over-filled, fuel can overflow onto a hot engine and cause FIRE or an EXPLOSION. Never store generator with fuel in tank where gasoline vapors might reach an open flame, spark or pilot light (as on a furnace, water heater or clothes dryer). FIRE or EXPLOSION may result. Allow unit to cool entirely before storage.
- Wipe up any fuel or oil spills immediately. Ensure that no combustible materials are left on or near the generator. Keep the area surrounding the generator clean and free from debris and keep a clearance of five (5) feet on all side to allow for proper ventilation of the generator.
- Do not insert objects through unit's cooling slots.
- Do not operate the generator if connected electrical devices overheat, if electrical output is lost, if engine or generator sparks or if flames or smoke are observed while unit is running.
- Keep a fire extinguisher near the generator at all times.

KEY TO SYMBOLS

WARNING



QUICK START AND SHUT DOWN



START

1. Add oil
2. Add fuel
3. Open fuel valve
4. Turn power switch to ON
5. Move choke to OFF
6. Pull the recoil starter
7. Move choke to ON and wait for 50 sec
8. Plug the electrical loads

SHUT DOWN

1. Unplug all electrical loads
2. Wait 30 sec and turn the power switch off
3. Close fuel valve

1300



Please note that the choke ON/OFF of 1300 is opposite with other model.

CHOKE AND FUEL SWITCH



NO OIL TAG

AIR FILTER

Clean filter every 50 hours of use
(see manual for instructions)

AIR FILTER MAINTENANCE



TYPE PLATE

Husqvarna		Prod. year 0000
Serial No	00000000	
Article no.	000 00 00-00	
Model	0 00000	
Weight	0000	
Engine displacement	00000	
Peak Power	00000	
Rated Power	00000	
Voltage	0000	
Rated Frequency	0000	
Phase	0	
HUSQVARNA AB SE-561 82 HUSQVARNA SWEDEN		

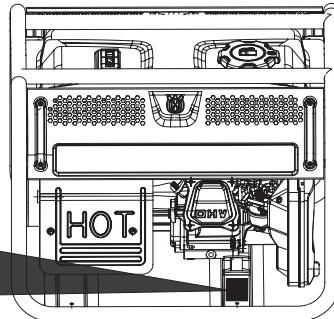

1. GENERAL INFORMATION

1.1 UNPACKING

- Remove all packaging material.
- Remove the generator from car ton.
- Remove separate parts(if any).

1.1.1 ACCESSORY (5500 & 8500)

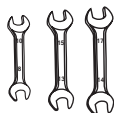
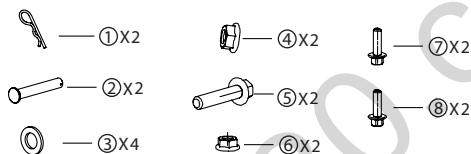
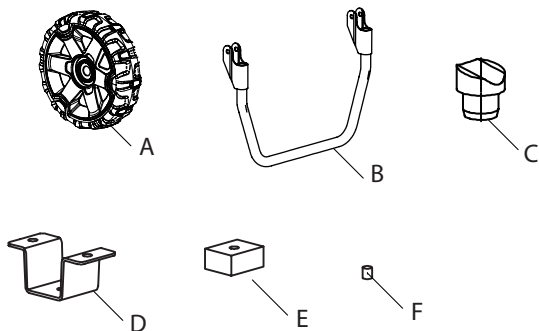

Check all contents. If any parts are missing or damaged, please contact the local dealer.

1.2 ASSEMBLY

The generator requires some assembly prior to using it. The following tools are for generator maintenance:

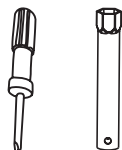

1.2.1 ASSEMBLING THE ACCESSORY KIT (5500 & 8500)

The wheels are designed to the unit to greatly improve the portability of the generator.

NOTICE: The wheels are not intended for over-the-road-use.

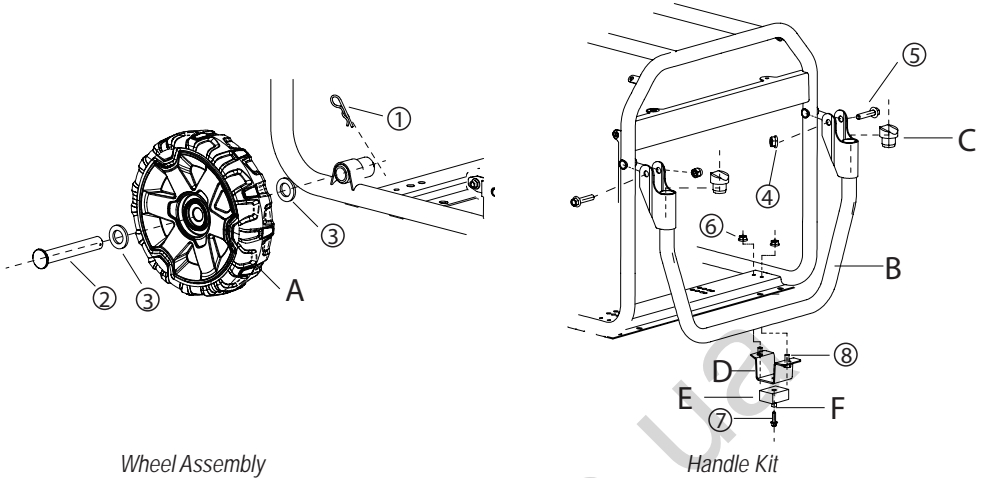

2. OPERATION

2.1 KNOW THE GENERATOR

Read the Owner's Manual and Safety Rules before operating this generator.

Familiar with the locations of various controls and adjustments. Save this manual for future reference.

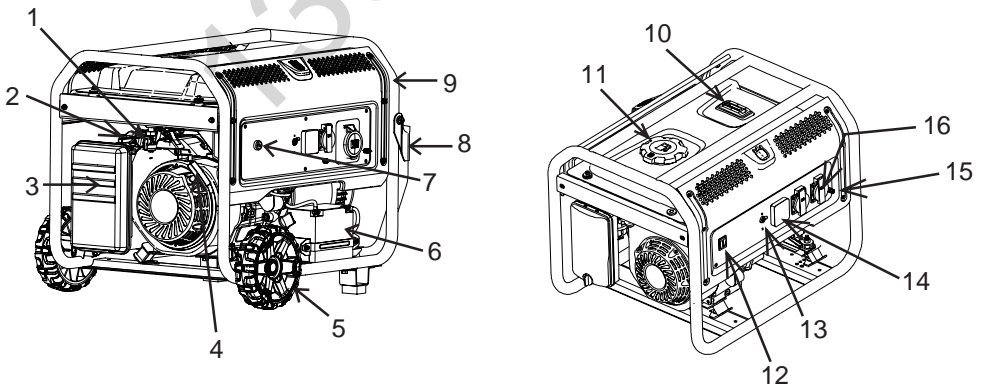

- | | | | | |
|--|------------------|-------------------------|-------------------|---------------------|
| 1. Fuel Valve | 2. Choke | 3. Air Filter | 4. Starter Handle | 5. Wheel |
| 6. Battery (12V,14A Non-maintenance battery recommended) | 7. Power switch | 8. Handle | 9. Frame | 10. Fuel gauge |
| 11. Fuel cap | 12. Power Switch | 13. AC Circuit Breakers | 14. V.F.T. Meter | 15. Ground Terminal |
| 16. AC Receptacle | | | | |

2.2 CORD SETS AND CONNECTION PLUGS

The following are descriptions of the controls on the power panel. Your generator has sockets to power your products with circuit breakers to protect the voltage flow.

1. Engine Switch: Used to start and stop the engine.



For recoil start.



For electric start.

2. Circuit Breakers: The circuit breaker protects the generator from overloading. The rating of the breaker and the load it protects are marked near the breaker. Should any of the circuit breakers trip, the generator will stop the electricity output. If this happens, unplug all loads from the generator. Allow the generator to cool down. Then, press the tripped circuit breaker, restart the engine, and re-attach loads.



ON
OFF

3. Grounding Terminal: Prior to each use, set up the ground wire (not included) connection to the grounding terminal to properly ground the generator.



4. 12 V DC Terminal: 12V DC terminal provides a power source for 12 volt DC items.



5. V.F.T Meter

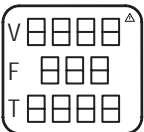

V means voltage of running.

F means frequency of running.

T means accumulative running time of the generator.



Means that the IK code of this meter is IK06, the surface of this meter was subject to one impact by a smooth steel sphere with a mass $500\text{ g} \pm 25\text{ g}$ and with a diameter of approximately 50 mm. Impact energy level is 1J, Height 200 mm.

6. AC Receptacles: The generator contains several AC Receptacles to power tools and equipment.

For different regions, the voltage and frequency will be different, please choose the proper generator.

EU Version, Single phase, 50Hz

- A. 2-Prong, 230 volt receptacle
- B. 3-Prong, 32A 230 volt receptacle

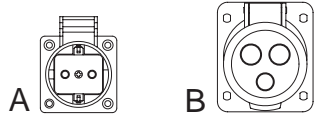

US Version, Single phase, 60Hz

- A. 3-Prong, duplex 120 volt receptacle
- B. 4-Prong, twistlock, 30A 120/240 volt receptacle
- C. 4-Prong, 50A 120/240 volt receptacle

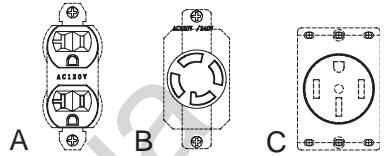

US Version, 3 phase, 60Hz

- A. 3-Prong, duplex 110 volt receptacle
- B. 5-Prong, 3 phase, 127/220 volt receptacle

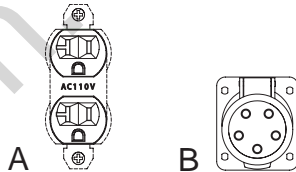

CN Version, Single phase, 50Hz

- A. 3-Prong, twistlock, 230 volt receptacle

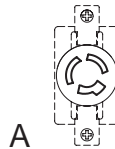

IMPORTANT: Do not overload the generator. Also, do not overload individual panel receptacles. These outlets are protected against overload with circuit breakers. If amperage rating of any circuit breaker is exceeded, that breaker opens and electrical output to that receptacle is lost. Read “Don’t Overload the Generator” carefully.

Control panel outline sample



2.3 HOW TO USE THE GENERATOR

If there are any problems operating the generator, please contact the local dealer.

DANGER!



 Never operate in an enclosed area or indoors! NEVER use in the home, in a vehicle, or in partly enclosed areas such as garages, EVEN IF doors and windows are open! ONLY use outdoors and far from open windows, doors, vents, and in an area that will not accumulate deadly exhaust.

 The engine exhaust fumes contain carbon monoxide, which you cannot see or smell. This poisonous gas, if breathed in sufficient concentrations, can cause unconsciousness or even death.

 Adequate, unobstructed flow of cooling and ventilating air is critical to correct generator operation. Do not alter the installation or permit even partial blockage of ventilation provisions, as this can seriously affect safe operation of the generator. The generator MUST be operated outdoors.

 This exhaust system must be properly maintained. Do nothing that might render the exhaust system unsafe or in noncompliance with any local codes and/or standards.

 Always use a battery operated carbon monoxide alarm indoors, installed according to the manufacturers instructions.

 DANGER	
Using a generator indoors CAN KILL YOU IN MINUTES.	
Generator exhaust contains carbon monoxide. This is a poison you cannot see or smell.	
 NEVER use inside a home or garage, EVEN IF doors and windows are open.	 Only use OUTSIDE and far away from windows, doors, and vents.

2.3.1 GROUNDING THE GENERATOR WHEN USED AS A PORTABLE

The generator must be properly grounded before use. Have the unit grounded by a qualified electrician if you are not qualified to do so.

To ground the generator, connect a 2.5 sqmm grounding wire (not included) from the grounding terminal on the control panel to a grounding rod (not included) that has been driven at least 24 inches earth-driven deep into the earth. The grounding rod must be an copper or brass rod (electrode) which can adequately ground the generator.

2.3.2 CONNECTING THE GENERATOR TO A BUILDING'S ELECTRICAL SYSTEM

When connecting directly to a building's electrical system, it is recommended that a manual transfer switch is used. Connections for a portable generator to a building's electrical system must be made by a qualified electrician and in strict compliance with all national and local electrical codes and laws.

Grounding the Generator



2.3.3 CONNECTING ELECTRICAL LOADS

DO NOT connect 240 (230) Volt loads to 120 (110) Volt receptacles.

DO NOT connect 3-phase loads to the single phase generator.

DO NOT connect 50 Hz loads to the 60 Hz generator, vice versa.

1. Let engine stabilize and warm up for a few minutes after starting.
2. Plug in and turn on the electrical loads.
3. Add up the rated watts (or ampere) of all loads to be connected at one time. This total should not be greater than (a) the rated wattage/ampere capacity of the generator or (b) circuit breaker rating of the receptacle supplying the power. See "Don't Overload the Generator".

2.4 DON'T OVERLOAD THE GENERATOR

Overloading a generator in excess of its rated wattage capacity can result in damage to the generator and to connected electrical devices. Observe the following to prevent overloading the unit:

- Add up the total wattage of all electrical devices to be connected at one time. This total should NOT be greater than the generator's wattage capacity.
- The rated wattage of lights can be taken from light bulbs. The rated wattage of tools, appliances and motors can usually be found on a data label or decal affixed to the device.
- If the appliance, tool or motor does not give wattage, multiply volts times ampere rating to determine watts (volts x ampere=watts).
- Some electric motors, such as induction types, require about three times more watts of power for starting than for running. This surge of power lasts only a few seconds when starting such motors. Make sure to allow for high starting wattage when selecting electrical devices to connect to the generator:

1. Figure the watts needed to start the largest motor.
2. Add to that figure the running watts of all other connected loads.

The Wattage Reference Guide is provided to assist in determining how many items the generator can operate at one time.

NOTICE! All figures are approximate. See data label on appliance for wattage requirements.

2.5 WATTAGE REFERENCE GUIDE

Device	Running Watts	Additional Start-up Watts
EMERGENCY		
Refrigerator/Freezer	700	1500
Radio	100	0
JOB SITE		
Air Compressor - 1/2 HP	1000	1000
Table Saw - 10"	1700	1300
Belt Sander - 3"	1200	1200
Hand Drill - 1/2"	600	600
Halogen Work Light	1000	0
Recipricating Saw	900	900
RECREATION		
AM/FM Radio	100	0
Electric Grill	1700	0
Inflator Pump50	100	
CD/DVD Player	100	0
Box Fan - 20"	200	200
Coffee Maker	600	0
HOUSEHOLD		
Computer w/ Monitor	800	0
Electric Clothes Dryer	5500	500
Electric Range	2100	0
Electric Water Heater	2000	0
Light Bulb - 100 watts	100	0
Microwave - 1000 watts	1000	200
Sump Pump - 1/2 HP	1000	1100
Television	400	0
Washing Machine	1100	1100
Well Pump - 1/2 HP	1000	1000
LAWN & GARDEN		
Hedge Trimmer	400	400
Pressure Washer	1200	1200
Lawn Mower	1200	1200
Edger	1000	1000
HEATING & COOLING		
Central AC - 10,000 BTU	1500	1500
Furnace Fan - 1/2 HP	900	1400
Space Heater	1800	0
Window AC - 10,000 BTU	1200	600

2.6 BEFORE STARTING THE GENERATOR

Prior to operating the generator, engine oil and gasoline will need to be added, as follows:

2.6.1 ADDING ENGINE OIL

All oil should meet minimum American Petroleum Institute (API) Service Class SJ, SL or better. Use no special additives. Select the oil's viscosity grade according to the expected operating temperature (also see chart).

- Above 40 F or 5 C, use SAE 30 or 10W-30
- Below 40 F or 5 C and down to 10 F or -12 C, use 10W-30
- Below 10 F or -12 C, use synthetic 5W-30

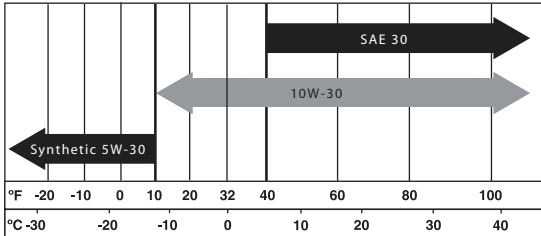

Temperature Range of Expected Use

⚠ CAUTION!

Any attempt to crank or start the engine before it has been properly serviced with the recommended oil may result in an engine failure.

1. Place generator on a level surface (not to exceed 15° in any direction).
2. Clean area around oil fill and remove oil fill cap and dipstick.
3. Wipe dipstick clean.
4. Slowly fill engine with oil through the oil fill opening until it reaches the high mark on the dipstick (Figure 1). Stop filling occasionally to check oil level. **Be careful not to over fill.**

Engine oil capacity:

1300: 0.45L **2500&3200:** 0.6L **5500&8500:** 1.1L

5. Install oil fill cap and finger tighten securely.
6. Check engine oil level before starting each time thereafter.

Figure 1 - Dipstick

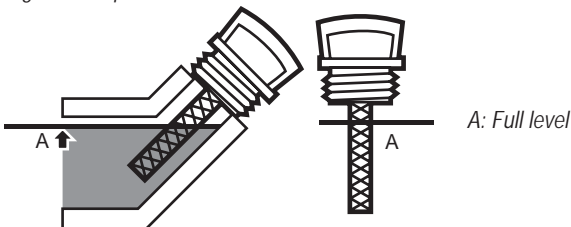

2.6.2 ADDING GASOLINE

⚠ DANGER!

⚠ Never fill fuel tank indoors. Never fill fuel tank when engine is running or hot. Avoid spilling gasoline on a hot engine. Allow engine to cool entirely before filling fuel tank. DO NOT light a cigarette or smoke when filling the fuel tank.

⚠ Do not overfill the fuel tank. Always leave room for fuel expansion. If the fuel tank is overfilled, fuel can overflow onto a hot engine and cause FIRE or EXPLOSION. Wipe up any spilled fuel immediately.

⚠ Never light a cigarette or smoke when filling the fuel tank. Gasoline is highly FLAMMABLE and its vapors are EXPLOSIVE. Never permit smoking, open flames, sparks or heat in the vicinity while handling gasoline.

1. Use regular UNLEADED gasoline with the generator engine. Do not use any gasoline with more than 10% added ethanol. Do not use E85 gasoline. Do not mix oil with gasoline.
2. Clean area around fuel fill cap, remove cap.
3. Slowly add unleaded regular gasoline to fuel tank. Be careful **not to overfill** (Figure 2).
4. Install fuel cap and wipe up any spilled gasoline.

Figure 2 - Fuel Tank

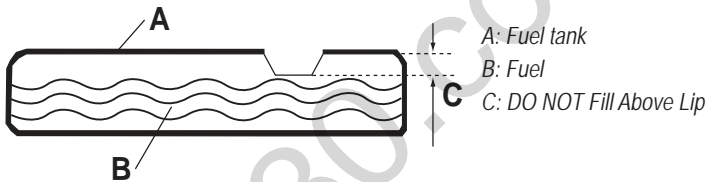

IMPORTANT: It is important to prevent gum deposits from forming in fuel system parts such as the carburetor, fuel hose or tank during storage. Alcohol-blended fuels (called gasohol, ethanol or methanol) can attract moisture, which leads to separation and formation of acids during storage. Acidic gas can damage the fuel system of an engine while in storage. To avoid engine problems, the fuel system should be emptied before storage of 30 days or longer. See the "Storage" section. Never use engine or carburetor cleaner products in the fuel tank as permanent damage may occur.

2.7 TO START THE ENGINE

WARNING!

Never start or stop engine with electrical devices plugged into the receptacles AND devices turned on.

1. Unplug all electrical loads from the unit's receptacles before starting the engine.
2. Make sure the unit is in a level position (not to exceed 15° in any direction).
3. OPEN the Fuel Valve.
4. Turn engine ON/OFF switch (A) (Recoil start engine only) to ON position. (Figure 3)
5. Move engine CHOKE lever to the OFF position.
6. To start engine, firmly grasp the recoil handle and pull slowly until increased resistance is felt. Pull rapidly up and away.

For electric start, to start the engine, press and hold the Off/On/Start key in the "Start" position. The engine will crank and attempt to start. When the engine starts, release the key to the "On" position.

7. When engine starts, move choke lever to 1/2-CHOKE position until engine runs smoothly and then fully into ON position. If engine falters, move choke back out to 1/2-CHOKE position. LEFT = CHOKE (OFF) RIGHT = ON (Figure 4).

NOTICE: If engine fires, but does not continue to run, move choke lever to the START position and repeat starting instructions.

Figure 3 - Engine On/Off switch

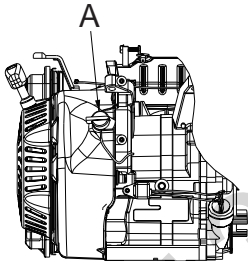
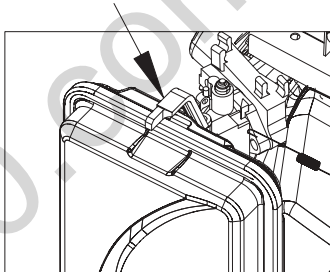

Figure 4 - Choke lever *Please note that the choke ON/OFF of 1300 is opposite with this*



2.8 STOPPING THE ENGINE

1. Shut off all loads, then unplug the electrical loads from generator panel receptacles. Never start or stop the engine with electrical devices plugged in and turned on.
2. Let engine run at no-load for 30 seconds to stabilize the internal temperatures of engine and generator.
3. Move ON/OFF switch to OFF position.
4. Close fuel valve.

2.9 LOW OIL LEVEL SHUTDOWN SYSTEM

The engine is equipped with a low oil level sensor that shuts down the engine automatically when the oil level drops below a specified level. If the engine shuts down by itself and the fuel tank has enough gasoline, check engine oil level.

2.9.1 SENSING LOW OIL LEVEL

If the system senses a low oil level during operation, the engine shuts down. The engine will not run until the oil has been refilled to the proper level.

3. MAINTENANCE

3.1 MAINTENANCE SCHEDULE

NOTICE: This maintenance schedule is intended solely as a general guide. If performance decreases or if equipment operates unusually, check systems immediately. The maintenance needs of each piece of equipment will differ depending on factors such as duty cycle, temperature, air quality, fuel quality, and other factors.

NOTICE: The following procedures are in addition to the regular checks and maintenance explained as part of the regular operation of the engine and equipment.

Procedure	Before Each Use	Monthly or every 20 hr. of use	Every 3 mo. or 50 hr. of use	Every 6 mo. or 100 hr. of use	Yearly or every 300 hr. of use	Every 2 Years
Brush off outside of engine	X	X	X	X	X	X
Check engine oil level	X	X	X	X	X	X
Check air cleaner	X		X	X	X	X
Check deposit cup	X			X	X	X
Change engine oil		X		X	X	X
Clean/replace air cleaner			X*	X	X	X
Check and clean spark plug				X	X	X
1. Check/adjust idle speed 2. Check/adjust valve clearance 3. Clean fuel tank, strainer and carburetor 4. Clean carbon build-up from combustion chamber					X**	X**
Replace fuel line if necessary						X**

* Service more frequently when used in dusty areas.

**These items should be serviced by a qualified technician.

3.2 PRODUCT SPECIFICATIONS

3.2.1 GENERATOR SPECIFICATIONS

Model	G 1300P	G 1300P	G 2500P	G 2500P	G 3200P
Engine displacement, cc	98,5	98,5	196	196	212
** Peak Power	1000W	1200W	2200W	2800W	3000W
Rated Power	800W	1000W	2000W	2500W	2800W
Voltage, V	230	110/220,120/240	230	110/220,120/240	230
Rated Frequency, Hz	50	60	50	60	50
Phase	1	1	1	1	1
Net weight, kg	28.0	28.0	43.0	43.0	49.0
Gross weight, kg	29.2	29.2	45.0	45.0	51.0
Packaging size, mm	500X375X435	500X375X435	500X375X435	500X375X435	625X495X495

** Maximum wattage is subject to, and limited by, such factors as fuel energy content, ambient temperature, altitude, engine condition, etc. Maximum power decreases about 3.5% for each 1,000 feet above sea level; and will also decrease about 1% for each 6° C (10° F) above 16°C (60° F) ambient temperature.

Model	G 3200P	G 5500P	G 5500P	G 8500P	G 8500P
Engine displacement, cc	212	389	389	458	458
** Peak Power	3200W	5500W	6000W	8000W	8500W
Rated Power	3000W	5000W	5500W	7500W	8000W
Voltage, V	110/220,120/240	230	110/220,120/240	230	110/220,120/240
Rated Frequency, Hz	60	50	60	50	60
Phase	1	1	1	1	1
Net weight, kg	49.0	88.0	88.0	106.4	106.4
Gross weight, kg	51.0	91.0	91.0	109.5	109.5
Packaging size, mm	625X495X495	720X560X585	720X560X585	720X560X585	720X560X585

** Maximum wattage is subject to, and limited by, such factors as fuel energy content, ambient temperature, altitude, engine condition, etc. Maximum power decreases about 3.5% for each 1,000 feet above sea level; and will also decrease about 1% for each 6° C (10° F) above 16°C (60° F) ambient temperature.

3.3 GENERAL RECOMMENDATIONS

The warranty of the generator does not cover items that have been subjected to operator abuse or negligence. To receive full value from the warranty, the operator must maintain the generator as instructed in this manual.

Some adjustments will need to be made periodically to properly maintain the generator. All adjustments in the Maintenance section of this manual should be made at least once each season. Follow the requirements in the “Maintenance Schedule”.

NOTICE: Once a year replace the spark plug and replace the air filter. A new spark plug and clean air filter assure proper fuel-air mixture and help the engine run better and last longer.

3.3.1 GENERATOR MAINTENANCE

Generator maintenance consists of keeping the unit clean and dry. Operate and store the unit in a clean dry environment where it will not be exposed to excessive dust, dirt, moisture or any corrosive vapors. Cooling air slots in the generator must not become clogged with snow, leaves, or any other foreign material.

Check the cleanliness of the generator frequently and clean when dust, dirt, oil, moisture or other foreign substances are visible on its exterior surface.

CAUTION!

Never insert any object or tool through the air cooling slots, even if the engine is not running.

NOTICE: DO NOT use a garden hose to clean generator. Water can enter the engine fuel system and cause problems. In addition, if water enters the generator through cooling air slots, some water will be retained in voids and crevices of the rotor and stator winding insulation. Water and dirt buildup on the generator internal windings will eventually decrease the insulation resistance of these windings.

3.3.2 TO CLEAN THE GENERATOR

- Use a damp cloth to wipe exterior surfaces clean.
- A soft, bristle brush may be used to loosen caked on dirt, oil, etc.
- A vacuum cleaner may be used to pick up loose dirt and debris.
- Low pressure air (not to exceed 25 psi) may be used to blow away dirt. Inspect cooling air slots and openings on the generator. These openings must be kept clean and unobstructed.

3.3.3 ENGINE MAINTENANCE

⚠ WARNING!

When working on the generator, always disconnect the spark plug wire from spark plug and keep wire away from spark plug.

3.3.4 CHECKING OIL LEVEL

See the “Before Starting the Generator” section for information on checking the oil level. The oil level should be checked before each use, or at least every eight hours of operation. Keep the oil level maintained (Figure 5).

3.3.5 CHANGING THE OIL

Change the oil after the first 20 hours of operation, then every 50 hours thereafter. If running this unit under dirty or dusty conditions, or in extremely hot weather, change the oil more often.

⚠ CAUTION!

Hot oil may cause burns. Allow engine to cool before draining oil. Avoid prolonged or repeated skin exposure with used oil. Thoroughly wash exposed areas with soap.

Use the following instructions to change the oil while the engine is still warm:

1. Clean area around oil drain plug (Figure 5).
2. Remove oil drain plug from engine and oil fill plug to drain oil completely into a suitable container.
3. When oil has completely drained, install oil drain plug and tighten securely.
4. Fill engine with recommended oil. (See “Before Starting the Generator” for oil recommendations).
5. Wipe up any spilled oil.
6. Dispose of used oil at a proper collection center.

Figure 5 - Oil Drain (A), Check & Fill (B)

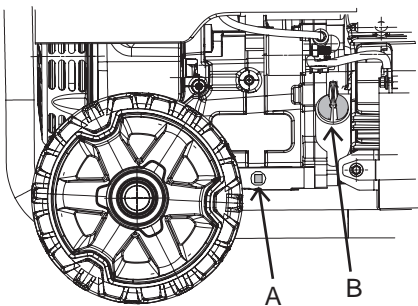

3.3.6 REPLACING THE SPARK PLUG

Replace the plug once each year. This will help the engine start easier and run better.

1. Stop the engine and pull the spark plug wire off of the spark plug.
2. Clean the area around the spark plug and remove it from the cylinder head.
3. Set the spark plug's gap to 0.76 mm (0.030 in.). Install the correctly gapped spark plug into the cylinder head and torque to 15 ft/lbs. (Figure 6).

Figure 6 - Spark Plug Gap

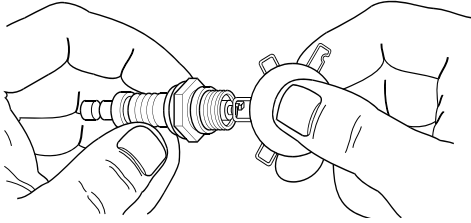

3.3.7 SPARK ARRESTOR

The engine exhaust muffler has a spark arrestor screen. Inspect and clean the screen at least once each year (Figure 7). If unit is used regularly, inspect and clean more often.

NOTICE: If using the generator on any forest-covered, brush-covered or grass-covered unimproved land, it must be equipped with a spark arrestor. The spark arrestor must be maintained in good condition by the owner/operator.

Clean and inspect the spark arrestor as follows:

1. Remove clamp (C) and spark arrestor screen (B) from muffler (A).
2. Inspect screen and replace if torn, perforated or otherwise damaged. DO NOT USE a defective screen. If screen is not damaged, clean it with commercial solvent.
3. Replace the spark arrestor and clamp.

Figure 7 - Spark Arrestor

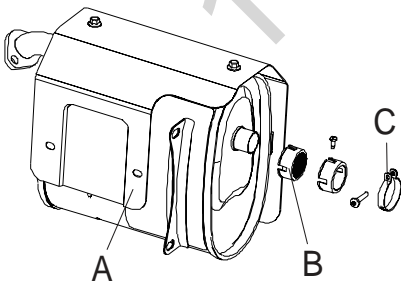

3.4 SERVICE AIR FILTER

The engine will not run properly and may be damaged if using a dirty air filter. Clean the air filter every 25 hours (Figure 8). Clean or replace more often if operating under dusty conditions.

1. Remove air filter cover.
2. Wash the element in soapy water. Squeeze filter dry in clean cloth (DO NOT TWIST).
3. Clean air filter cover before re-installing it.

Figure 8 - Air Filter

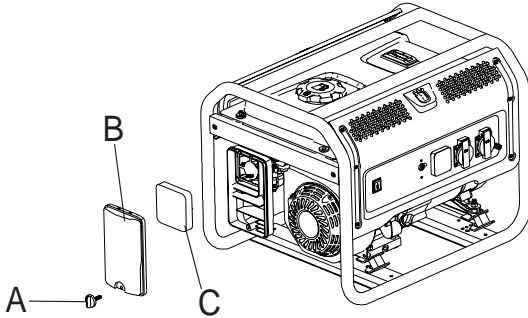

A: BOLT B: AIR FILTER COVER C: FILTER ELEMENT

3.5 GENERAL

The generator should be started at least once every 30 days and be allowed to run at least 30 minutes. If this cannot be done and the unit must be stored for more than 30 days, use the following information as a guide to prepare it for storage.

⚠ WARNING!

⚠ NEVER store engine with fuel in tank indoors or in enclosed, poorly ventilated areas where fumes may reach an open flame, spark or pilot light as on a furnace, water heater, clothes dryer or other gas appliance.

3.6 LONG TERM STORAGE

It is important to prevent gum deposits from forming in essential fuel system parts such as the carburetor, fuel hose or tank during storage. Also, experience indicates that alcohol-blended fuels (called gasohol, ethanol or methanol) can attract moisture, which leads to separation and formation of acids during storage. Acidic gas can damage the fuel system of an engine while in storage.

To avoid engine problems, the fuel system should be emptied before storage of 30 days or longer, as follows:

1. Add a quality gasoline stabilizer to the fuel per the manufacturers specifications, and run the unit for 10-15 minutes.
2. After engine cools down, remove all gasoline from the fuel tank. Use a commercially available, non-conductive vacuum siphon.

 **DANGER!**

 **Drain fuel into approved container outdoors, away from open flame. Be sure engine is cool. Do not smoke.**

3. Start and run engine until engine stops from lack of fuel.
4. After engine cools down, drain oil from engine. Refill with recommended grade.
5. Remove spark plug and pour about 1/2 ounce (15 ml) of engine oil into the cylinder. Cover spark plug hole with rag. Pull the recoil starter a couple times to lubricate the piston rings and cylinder bore. A fogging agent can also be used in the place of oil.

 **CAUTION!**

Avoid spray from spark plug hole when cranking engine.

6. Install and tighten spark plug. Do not connect spark plug wire.
7. Clean the generator outer surfaces. Check that cooling air slots and openings on generator are open and unobstructed.
8. Store the unit in a clean, dry place.

3.7 OTHER STORAGE TIPS

- Do not store gasoline from one season to another.
- Replace the gasoline can if it starts to rust. Rust and/or dirt in the gasoline will cause problems with the carburetor and fuel system.
- If possible, store the unit indoors and cover it to give protection from dust and dirt. **BE SURE TO EMPTY THE FUEL TANK.**
- If it is not practical to empty the fuel tank and the unit is to be stored for some time, use a commercially available fuel stabilizer added to the gasoline to increase the life of the gasoline.
- Cover the unit with a suitable protective cover that does not retain moisture.

 **WARNING!**

NEVER cover the generator while engine and exhaust area are warm.

4. TROUBLESHOOTING

4.1 TROUBLESHOOTING GUIDE

Problem	Possible Causes	Probable Solutions
Engine stops when under heavy load	<ol style="list-style-type: none"> 1. Dirty air filter. 2. Engine running cold. 	<ol style="list-style-type: none"> 1. Clean or replace element. 2. Allow engine to warm up prior to operating equipment.
Engine misfires	<ol style="list-style-type: none"> 1. Spark plug cap loose. 2. Incorrect spark plug gap or damaged spark plug. 3. Defective spark plug cap. 4. Old or low quality gasoline. 5. Incorrect compression. 	<ol style="list-style-type: none"> 1. Check wire connections. 2. Re-gap or replace spark plug. 3. Replace spark plug cap. 4. Use only fresh 87+ octane stabilizer treated unleaded gasoline. Do not use gasoline with more than 10% ethanol (E15, E20, E85, etc.). 5. Diagnose and repair compression.
Engine stops suddenly	<ol style="list-style-type: none"> 1. Low oil shutdown. 2. Fuel tank empty or full of impure or low quality gasoline. 3. Defective fuel tank cap creating vacuum, preventing proper fuel flow 4. Faulty magneto. 5. Disconnected or improperly connected spark plug cap. 	<ol style="list-style-type: none"> 1. Fill engine oil to proper level. Check engine oil before EVERY use. 2. Fill fuel tank with fresh 87+ octane stabilizer treated unleaded gasoline. Do not use gasoline with more than 10% ethanol (E15, E20, E85, etc.). 3. Test/replace fuel tank cap. 4. Have qualified technician service magneto. 5. Secure spark plug cap.
Engine knocks	<ol style="list-style-type: none"> 1. Old or low quality gasoline. 2. Engine overloaded. 3. Incorrect spark timing, deposit buildup, worn engine, or other mechanical problems. 	<ol style="list-style-type: none"> 1. Fill fuel tank with fresh 87+ octane stabilizer treated unleaded gasoline. Do not use gasoline with more than 10% ethanol (E15, E20, E85, etc.). 2. Do not exceed equipment's load rating. 3. Have qualified technician diagnose and service engine.
Engine backfires	<ol style="list-style-type: none"> 1. Impure or low quality gasoline. 2. Engine too cold. 3. Intake valve stuck or overheated engine. 4. Incorrect timing. 	<ol style="list-style-type: none"> 1. Fill fuel tank with fresh 87+ octane stabilizer treated unleaded gasoline. Do not use gasoline with more than 10% ethanol (E15, E20, E85, etc.). 2. Use cold weather fuel and oil additives to prevent backfiring. 3. Have qualified technician diagnose and service engine. 4. Check engine timing.

Problem	Possible Causes	Probable Solutions
Product doesn't have power.	<ol style="list-style-type: none"> 1. Product not plugged in properly. 2. Circuit Breaker tripped. 3. Receptacle activated. 4. Product needs service. 	<ol style="list-style-type: none"> 1. Turn off and unplug the product, then plug it back in again and turn on. 2. Turn off and unplug product. Reset Circuit Breaker. Plug in product and turn on. 3. Turn off and unplug product. Test receptacle. If functioning properly reset receptacle, plug in product and turn on. 4. Have product repaired.
Product begins to operate abnormally.	<ol style="list-style-type: none"> 1. Problem with appliance. 2. Rated load capacity exceeded. 	<ol style="list-style-type: none"> 1. Immediately unplug appliance. Have appliance repaired by a qualified technician, or replace appliance. 2. Lower the number of items plugged into the Generator to stay within the rated capacity, or use a more powerful generator.

130.com.ua

CE 5. EC DECLARATION OF CONFORMITY CE

5.1 EC DECLARATION OF CONFORMITY FOR THE FOLLWING MACHINERY:

Product name: Portable Generator
Commercial name: N/A
Function: Low-power generating set
Type: Gasoline
Model number: G 1300P, G 2500P, G 3200P, G 5500P, G 8500P
Serial number: 1804000005, 1804000013, 1804000026, 1804000032, 19D150001

is herewith confirmed to fulfill all the relevant provisions of

- Machinery Directive (2006/42/EC)

and the following harmonized standard have been complied with:

- EN ISO 8528-13:2016

is herewith confirmed to fulfill all the relevant provisions of

- Electromagnetic Compatibility Directive (2014/30/EU)

and the following harmonized standard have been complied with:

- EN 61000-6-1:2007; EN 55012:2007+A1

is herewith confirmed to fulfill all the relevant provisions of

- Noise Emission Directive by equipment for use outdoors (2000/14/EC + 2005/88/EC)

Conformity Assessment Procedure: 2000/14/EC, amended by 2005/88/EC- Annex VI

Model	G 1300P	G 2500P	G 3200P	G 5500P	G 8500P
Measured sound power level	93 dB(A)	93 dB(A)	94 dB(A)	95 dB(A)	95 dB(A)
Guaranteed sound power level	95 dB(A)	95 dB(A)	96 dB(A)	97 dB(A)	97 dB(A)

Responsible for marking this declaration is the

Manufacturer's Name: Husqvarna AB
Manufacturer's Address: SE-561 82 Huskvarna Sweden

Person responsible for compiling the technical files established within the EU

Name, Surname: Peter Mejegård
Address: Husqvarna AB

Person responsible for making this declaration

Name, Surname: Claes Losdal
Position/Title: R&D Director
Place: Huskvarna
Date: 2018-03-23



(Company stamp and legal signature)

130.com.ua

Original instructions

1140437-26, rev. 2

2019-06-18

Autogoods "130"