



PHONES

0 (800) 800 130  
(050) 462 0 130  
(063) 462 0 130  
(067) 462 0 130

130  
COM.UA

Internet store of  
autogoods



SKYPE

km-130

CAR RECEIVERS — Receivers • Media receivers and stations • Native receivers • CD/DVD changers • FM-modulators/USB adapters • Flash memory • Facia plates and adapters • Antennas • Accessories |  
 CAR AUDIO — Car audio speakers • Amplifiers • Subwoofers • Processors • Crossovers • Headphones • Accessories | TRIP COMPUTERS — Universal computers • Model computers • Accessories |  
 GPS NAVIGATORS — Portable GPS • Built-in GPS • GPS modules • GPS trackers • Antennas for GPS navigators • Accessories | VIDEO — DVR • TV sets and monitors • Car TV tuners • Cameras • Videomodules  
 • Transcoders • Car TV antennas • Accessories | SECURITY SYSTEMS — Car alarms • Bike alarms • Mechanical blockers • Immobilizers • Sensors • Accessories | OPTIC AND LIGHT — Xenon • Bixenon • Lamps  
 • LED • Stroboscopes • Optic and Headlights • Washers • Light, rain sensors • Accessories | PARKTRONICS AND MIRRORS — Rear parktronic • Front parktronic • Combined parktronic • Rear-view mirrors  
 • Accessories | HEATING AND COOLING — Seat heaters • Mirrors heaters • Screen-wipers heaters • Engine heaters • Auto-refrigerators • Air conditioning units • Accessories | TUNING — Vibro-isolation  
 • Noise-isolation • Tint films • Accessories | ACCESSORIES — Radar-detectors • Handsfree, Bluetooth • Windowlifters • Compressors • Beeps, loudspeakers • Measuring instruments • Cleaners • Car seats  
 • Miscellaneous | MOUNTING — Installation kits • Upholstery • Grilles • Tubes • Cable and wire • Tools • Miscellaneous | POWER — Batteries • Converters • Start-charging equipment • Capacitors  
 • Accessories | MARINE AUDIO AND ELECTRONICS — Marine receivers • Marine audio speakers • Marine subwoofers • Marine amplifiers • Accessories | CAR CARE PRODUCTS — Additives • Washer fluid •  
 Care accessories • Car polish • Flavors • Adhesives and sealants | LIQUID AND OIL — Motor oil • Transmission oil • Brake fluid • Antifreeze • Technical lubricant



In store "130" you can find and buy almost all necessary goods for your auto in Kyiv and other cities, delivery by ground and postal services. Our experienced consultants will provide you with exhaustive information and help you to choose the very particular thing. We are waiting for you at the address

<https://130.com.ua>



 **Husqvarna**<sup>®</sup>



520iRX

130.com.ua

# Contents

Introduction.....	2	Troubleshooting.....	29
Safety.....	4	Transportation, storage and disposal.....	30
Assembly.....	20	Technical data.....	31
Operation.....	22	Accessories.....	32
Maintenance.....	27	EC Declaration of Conformity.....	33

## Introduction

### Product description

Husqvarna 520iRX is a battery grass trimmer with an electrical motor.

Work is constantly in progress to increase your safety and efficiency during operation. Speak to your servicing dealer for more information.

product for other tasks than grass trimming and grass clearing. Use a grass blade or trimmer head to cut grass.

**Note:** National or local regulations may regulate the use. Comply to given regulations.

### Intended use

The product can be used with a grass blade or a trimmer head to cut different types of vegetation. Do not use the

### Product overview

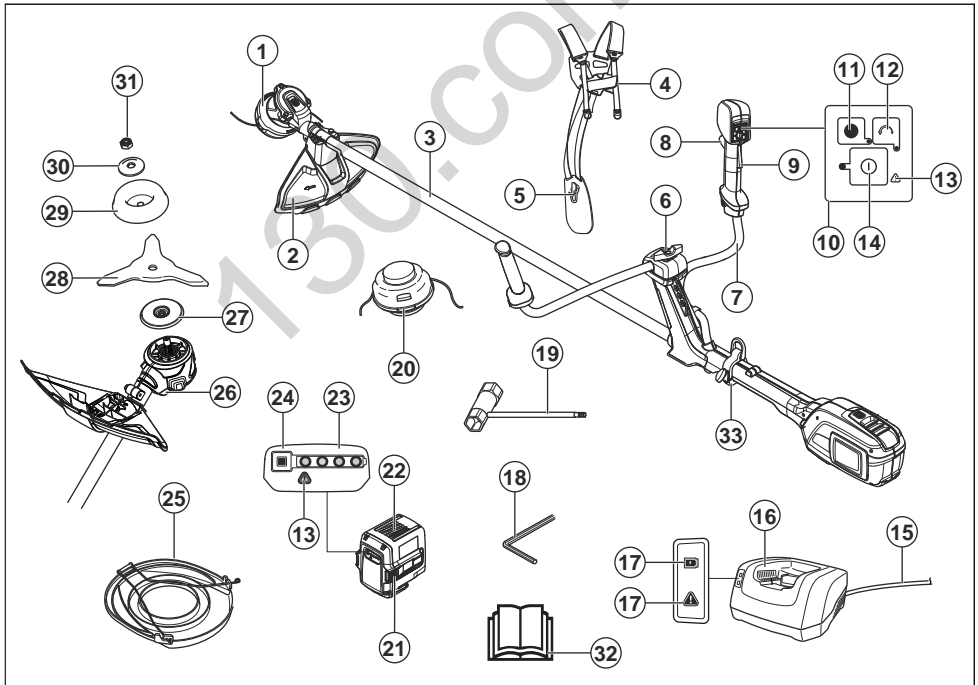

1. Trimmer head

2. Cutting attachment guard

3. Shaft
4. Harness quick release
5. Harness, hip pad
6. Handle adjustment
7. Handlebar
8. Power trigger
9. Power trigger lockout
10. Keypad
11. SavE button
12. Rotation direction button
13. Warning indicator (error LED)
14. Start and stop button
15. Cord
16. Battery charger
17. Power on and warning indicator (error LED)
18. 4 mm hex key
19. Socket wrench
20. Trimmer head
21. Battery release buttons
22. Battery
23. Battery status
24. Battery indicator button
25. Transport guard
26. Hole for locking pin 4 mm hex key
27. Drive disc
28. Blade
29. Support cup
30. Support flange
31. Locknut
32. Operator's manual
33. Loop hanger

## Symbols on the product



**WARNING!** This product can be dangerous! Careless or incorrect use can result in serious injury to the operator or others. It is very important that you read and understand the contents of the operator's manual. Please read the operator's manual carefully and make sure you understand the instructions before the product is used.



Use approved eye protection.



Maximum speed of the output shaft.



The product agrees with the applicable EC directives.



Keep a minimum distance of 15 m to persons and animals during operation of the product.



Use approved protective gloves.



Use heavy-duty slip-resistant boots.



Risk of blade thrust if the cutting equipment touches an object that it does not immediately cut. The product can cut off body parts. Keep a minimum of 15 m distance to persons and animals during operation of the product.



Symbols on the product or its packaging indicate that this product cannot be handled as domestic waste. This product must be deposited at an appropriate recycling facility.



The product can cause objects to eject, which can cause injury.



Use flexible cutting wire as trimmer line. Do not use metal cutting elements.



The arrows show the limit for the handle position.

**IPX4**

Protected against splashing water.



Direct current.



Noise emission to the environment refer to the European Community's Directive. The emission of the product is specified in the Technical data chapter and on the label.

yyyyywwxxxx

The rating plate shows the serial number. **yyyyy** is the production year, **ww** is the production week and **xxxx** is the sequential number.

## Symbols on the battery and/or on the battery charger

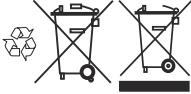

Recycle this product at a recycling station for electrical and electronic equipment. (Applies to Europe only)



Fail-safe transformer.



Use and keep the battery charger indoors only.



Double insulation.

## Product liability

As referred to in the product liability laws, we are not liable for damages that our product causes if:

- the product is incorrectly repaired.
- the product is repaired with parts that are not from the manufacturer or not approved by the manufacturer.
- the product has an accessory that is not from the manufacturer or not approved by the manufacturer.
- the product is not repaired at an approved service center or by an approved authority.

---

## Safety

---

### Safety definitions

Warnings, cautions and notes are used to point out specially important parts of the manual.



**WARNING:** Used if there is a risk of injury or death for the operator or bystanders if the instructions in the manual are not obeyed.



**CAUTION:** Used if there is a risk of damage to the product, other materials or the adjacent area if the instructions in the manual are not obeyed.

**Note:** Used to give more information that is necessary in a given situation.

### General power tool safety warnings



**WARNING:** Read all safety warnings and all instructions. Failure to follow the warnings and instructions may result in electric shock, fire and/or serious injury.

**Note: Save all warnings and instructions for future reference.** The term "power tool" in the warnings refers to your mains-operated (corded)

power tool or battery-operated (cordless) power tool.

---

### **Check before starting**

- Always remove the battery to prevent the product being started by accident. Always remove the battery before any maintenance on the product.
- Before using the product and after any impact, check for signs of wear or damage and repair as necessary.
- Inspect the working area. Remove all loose objects, such as stones, broken glass, nails, steel wire, string etc. that could be thrown out or become wrapped around the cutter or cutter guard.
- Check the motor for dirt and cracks. Clean off grass and leaves from the engine using a brush. Gloves should be worn when necessary.
- Check that the trimmer head is completely attached to the trimmer.
- Check that the product is in perfect working order. Check that all nuts and screws are tight.
- Check that the trimmer head and trimmer guard are not damaged or cracked. Replace the trimmer head or trimmer guard if they have been exposed to impact or are cracked. Always use the recommended guard for the cutting attachment you are using. See chapter on Technical data.
- The product operator must ensure that no people or animals come closer than 15 meters while working. When several operators are working in the same area the safety distance should be at least 15 meters.
- Carry out an overall inspection of the product before use. See the maintenance schedule.
- National or local regulations may regulate the use. Comply to given regulations.

### **Personal safety**

- The cutting tool does not stop immediately after the product is turned off.
- The product is only designed for trimming.
- Keep bystanders away.
- **Stay alert, watch what you are doing and use common sense when operating a**

**power tool. Do not use a power tool while you are tired or under the influence of drugs, alcohol or medication.**

A moment of inattention while operating power tools may result in serious personal injury.

- This appliance is not intended for use by person (including children) with reduced physical, sensory or mental capabilities, or lack of experience and knowledge, unless they have been given supervision or instruction concerning use of the appliance by a person responsible for their safety. Children should be supervised to ensure that they do not play with the appliance.
- Never allow children or other persons not trained in the use of the product and/or the battery to use or service it. Local laws may regulate the age of the user.
- Store the equipment in a lockable area so that it is out of reach of children and unauthorized persons.
- Keep hands and feet away from the cutting area at all

times and especially when switching on the motor.

- **Dress properly. Do not wear loose clothing or jewelry. Keep your hair, clothing and gloves away from moving parts.** Loose clothes, jewelry or long hair can be caught in moving parts.
- Wear personal protective equipment. See instructions under the "Personal protective equipment" heading.
- Always use face or dust mask if operation is dusty.
- Turn off the product when it has to be moved. Always remove the battery when passing the machine to another person.
- Keep in mind that it is you, the operator that is responsible for not exposing people or their property to accidents or hazards.
- The transport guard must always be used for storage and transport.

### **Power tool use and care**

- The only accessories you can operate with this product are the cutting attachments we

- recommend in the technical data chapter.
- Never use a product that has been modified in any way from its original specification. Never use the product near explosive or flammable materials.
  - Never use a product that is faulty. Carry out the safety checks, maintenance and service instructions described in this manual. Some maintenance and service measures must be carried out by trained and qualified specialists. See instructions under the Maintenance heading.
  - Only use original spare parts.
  - Always ensure that ventilation openings are kept clear of debris.
  - Keep handles dry, clean and free from oil and grease.
  - All covers, guards and handles must be fitted before starting.
  - Only use the machine in daylight or in other well-lit conditions.
  - Do not overreach. Keep proper footing and balance at all times.
  - Don't force the product. It will do the job better and with less likelihood of injury at the rate for which it was designed.
  - Working in bad weather is tiring and often brings added risk. It is not recommended to use the product in very bad weather, for instance, in dense fog, in heavy rain, strong winds, intense cold, risk of lightning.
  - If the product starts vibrating abnormally, stop the product and remove the battery.
  - Avoid Unintentional Starting – Don't carry appliance with finger on switch.
  - Store Idle Appliances Indoors – When not in use, appliances should be stored indoors
  - Walk, never run.

### **Always use common sense**

It is not possible to cover every conceivable situation you can face. Always exercise care and use your common sense. Avoid all situations which you consider to be beyond your capability. If you still feel uncertain about operating procedures after reading these instructions, you should consult an expert before continuing.





---

**WARNING:** Never allow children to use or be in the vicinity of the machine. Since the machine is easy to start, children may be able to start it if they are not kept under full surveillance. This can mean a risk of serious personal injury. Therefore disconnect the battery when the machine is not under close supervision.

---

### General safety instructions

---



**WARNING:** Read the warning instructions that follow before you use the product.

---

- Remove the battery to prevent the product from being started by accident.
- This product is a dangerous tool if you are not careful or if you use the product incorrectly. This product can cause serious injury or death to the operator or others.
- Do not use the product if it is changed from its initial specification. Do not change a part of the product without approval from the manufacturer. Only use parts that are approved by the manufacturer. Injury or death is a possible result of incorrect maintenance.
- Do a check of the product before use. See, *Safety devices on the product on page 15* and *Maintenance on page 27*. Do not use a defective product. Do the safety checks, maintenance and service instructions described in this manual.
- Children should be supervised to ensure that they do not play with the product. Never allow children or other persons not trained in the use of the product and/or the battery to use or service it. Local laws may regulate the age of the user.
- Keep the product in a locked area to prevent access for children or persons that are not approved.
- Store the product out of reach of children.
- Under no circumstances may the design of the product be modified without the permission of the manufacturer. Always use

original accessories. Non-authorized modifications and/or accessories can result in serious personal injury or the death of the operator and others.

**Note:** National or Local laws can regulate the use. Comply to given regulations.

### Safety instructions for assembly

#### Assembly of blades and trimmer heads



**WARNING:** When you install the cutting attachment it is very important that the raised section on the drive disc/support flange engages correctly in the centre hole of the cutting attachment. If the cutting attachment is install incorrectly it can result in serious and/or fatal personal injury.

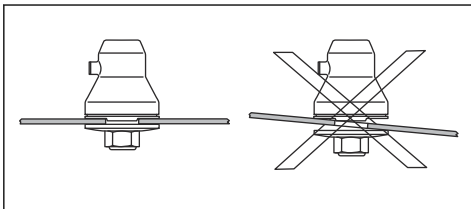

**WARNING:** Never use a cutting attachment without an approved guard. See the chapter on Technical data. If an incorrect or faulty guard is fitted this can cause serious personal injury.

### Safety instructions for operation



**WARNING:** Read the warning instructions that follow before you use the product.

- If you encounter a situation where you are uncertain how to proceed you should ask an expert. Contact your dealer or your service workshop. Avoid all usage which you consider to be beyond your capability.
- Never use the product if you are fatigued, while under the influence of alcohol or drugs, medication or anything that could affect your vision, alertness, coordination or judgment.
- Faulty cutting attachment can increase the risk of accidents.
- Do not allow children to use or be in the vicinity of the product. Since the product is

easy to start, children may be able to start it if they are not kept under full surveillance.

This can mean a risk of serious personal injury.

Disconnect the battery when the product is not under close supervision.

- Ensure that no people or animals come closer than 15 metres while you work. When several operators are working in the same area the safety distance should be at least 15 metres. Otherwise there is a risk of serious personal injury. Stop the product immediately if anyone approaches. Never swing the product around without first checking behind you to make sure that no one is within the safety zone.
- Ensure that people, animals or other things can not affect your control of the product or that they do not come in contact with the cutting attachment or loose objects that are thrown out by the cutting attachment. However, do not use the product unless you are able to call for help in the event of an accident.
- Always inspect the working area. Remove all loose objects such as stones, broken glass, nails, steel wire, string, etc., that could be thrown out or become wrapped around the cutting attachment.
- Make sure that you can move and stand safely. Check the area around you for possible obstacles (roots, rocks, branches, ditches, etcetera) in case you have to move suddenly. Take great care when you work on sloping ground.
- Keep a good balance and a firm foothold at all times. Do not overreach.
- Deactivate the product before you move to another area.
- Never put the product down unless you have deactivated it and removed the battery. Do not leave the product unsupervised when it is switched on.
- Remove the battery before you pass the product to another person.
- Make sure that no clothes or parts of the body come in contact with the cutting attachment when the product

- is activated. Keep the product below waist level.
- If anything jams in the cutting attachment while you operate the product, stop and deactivate the product. Make sure that the cutting attachment stops completely. Remove the battery before you clean, inspect or repair the product and/or the cutting equipment. There is a risk of burns as the gear housing can become very hot. Use gloves when working with the cutting attachments.
  - Keep your hands and feet away from the cutting attachment until it has stopped completely when the product is deactivated.
  - Watch out for stumps of branches that can be thrown out when you cut. Do not cut too close to the ground where stones and other objects can be thrown out.
  - Watch out for thrown objects. Always wear approved eye protection. Never lean over the cutting attachment guard. Stones, rubbish, etc., can be thrown up into the eyes which can cause blindness or serious injury.
  - Listen out for warning signals or shouts when you wear hearing protection. Always remove your hearing protection as soon as the product stops.
  - Never work from a ladder, stool or any other raised position that is not fully secured.
  - If any unwanted vibrations occur, tap out new line to give the line the correct length to stop the vibrations.
  - Overexposure to vibration can lead to circulatory damage or nerve damage in persons who have poor circulation. Speak to your physician if you experience symptoms of overexposure to vibration. Such symptoms include numbness, loss of feeling, tingling, pricking, pain, loss of strength, changes in skin colour or condition. These symptoms usually show in the fingers, hands or wrists.
  - Always hold the product with both hands. Hold the product on the right side of your body.
  - Do not remove the cut material, or let other persons remove cut material, while the product is on or the cutting

equipment rotates, as this can result in serious injury.

- Always stop the product, remove the battery and make sure that the cutting equipment does not rotate before you remove material that is wound around the blade shaft or caught between the guard and the cutting attachment.
- This product produces an electromagnetic field during operation. This field may under some circumstances interfere with active or passive medical implants. To reduce the risk of serious or fatal injury, we recommend persons with medical implants to consult their physician and the medical implant manufacturer before operating this machine.
- Release the power trigger after each working operation to save battery power.
- Don't force the product. It will do the job better and with less likelihood of a risk of injury at the rate for which it was designed.
- If any foreign object is hit or if vibrations occur stop the product immediately. Remove

the battery from the product and check that the product is not damaged.

- Products fitted with grass blades can be thrown violently to the side when the blade comes into contact with a fixed object. This is called blade thrust. A blade thrust can be violent enough to cause the product and/or operator to be propelled in any direction, and possibly lose control of the product. Blade thrust can occur without warning if the product snags, stalls or binds. Blade thrust is more likely to occur in areas where it is difficult to see the material being cut. Avoid cutting with the area of the blade between the 12 o'clock and 3 o'clock positions. Because of the speed of rotation of the blade, blade thrust can occur if you attempt to cut thick stems with this area of the blade.
- Do not use grass blades or grass knives on woody stems.
- When working with a brushcutter the harness should always be worn. Otherwise you will be unable

to control the brushcutter safely and this can result in injury to yourself or others. Never use a harness with a defective quick release.

### Personal protective equipment



**WARNING:** Read the warning instructions that follow before you use the product.

- Always use approved personal protective equipment when you use the product. Personal protective equipment cannot fully prevent injury but it decreases the degree of injury if an accident does occur. Let your dealer help you select the right equipment.
- Use a protective helmet where there is a risk of falling objects.

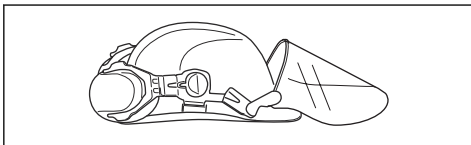

- Long term exposure to noise can result in damaged hearing. In general, battery powered products are relatively quiet but damage

can result from a combination of noise level and long usage. recommends that operators use hearing protectors when using products for a longer coherent time of a day. Continual and regular users should have their hearing checked regularly.

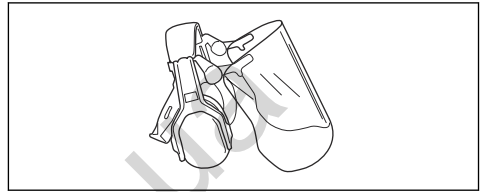

**WARNING:** Hearing protectors limit the ability to hear sounds and warning signals.

- Use approved eye protection. If you use a visor, you must also use approved protective goggles. Approved protective goggles must comply with the ANSI Z87.1 standard in the USAs or EN 166 in EU countries.

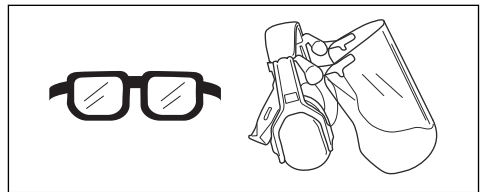

- Use gloves when necessary, for example when you attach,

examine or clean the cutting equipment.

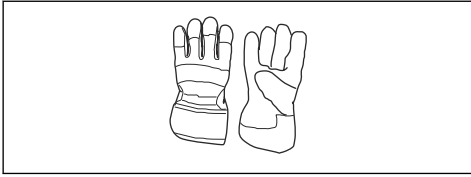

- Use sturdy non-slip boots.

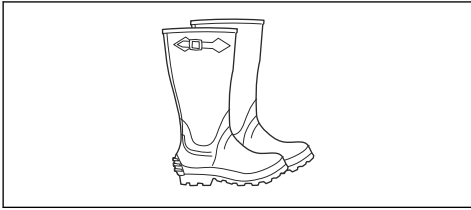

- Use clothing made of a strong fabric. Always use heavy, long pants and long sleeves. Do not use loose clothing that can catch on twigs and branches. Do not wear jewelry, short pants, sandals or go with bare feet. Put your hair up safely above shoulder level.
- Keep first aid equipment close at hand.

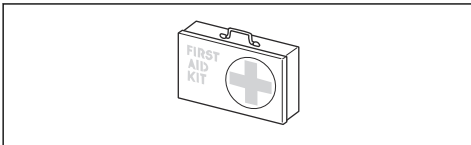

## Cutting attachment



**WARNING:** Remove the battery and make sure that the cutting

attachment stops completely before you work on any part of the cutting attachment.



**WARNING:** Use correct cutting attachment. Only use the cutting attachment with the guards we recommend, refer to *Accessories on page 32*. Make sure that the cutting attachment is sharpened correctly. A cutting attachment that is not sharpened correctly increases the risk of blade thrust.



**WARNING:** An incorrectly sharpened or damaged blade increases the risk of accidents. Keep the teeth of the blade correctly sharpened. Follow the instructions and use the recommended file gauge.



**CAUTION:** An incorrectly set saw blade increases the risk of jamming and blade thrust. This can damage the saw blade.

Keep the correct setting on the saw blade. Follow the instructions and use the recommended setting tool.

---

Wear protective gloves when the cutting attachment is handled.

- Use the saw blade to cut fibrous types of wood.
- Use the blades and grass knives to cut coarse grass.
- Use the trimmer head to trim grass.
- Check the cutting attachment for damage or cracks. Replace a damaged cutting attachment.

#### Trimmer head

- Always use the correct trimmer head and cutting attachments, See *Accessories on page 32*. Also, use the trimmer line we recommend, see the assembly in the back of the Manual.
- Make sure that the cutter on the trimmer guard is intact.
- Make sure that the trimmer line is wound tightly and evenly around the drum to prevent dangerous vibrations from the product. Different cord lengths can result in unnecessary vibrations. Tap the trimmer head to get correct length on the cord.

To increase the life of the cord it can be soaked in water for a couple of days before it is assembled. This will make the cord tougher.

## Safety devices on the product

---



**WARNING:** Read the warning instructions that

follow before you use the product.

---

- In this section the product's safety features, its purpose and how checks and maintenance should be carried out to ensure that it operates correctly. See instructions under the heading *Product overview on page 2* to find where these parts are located on your product.
- The life span of the product can be reduced and the risk of accidents can increase if product maintenance is not carried out correctly and if service and/or repairs are not carried out professionally. If you need further information please contact your nearest servicing dealer.
- Never use a product with defective safety components. The product's safety equipment must be inspected and maintained as described in this section. If your product fails any of these checks, contact your service agent to get it repaired.
- All servicing and repair work on the machine requires special training. This is especially true of the machine



's safety equipment. If your machine fails any of the checks described below you must contact your service agent. When you buy any of our products we guarantee the availability of professional repairs and service. If the retailer who sells your machine is not a servicing dealer, ask him for the address of your nearest service agent.

**To do a check of the keypad**

1. Press and hold the start/stop button (A).

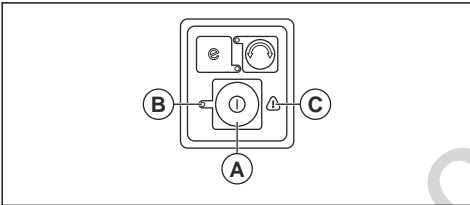

- a) The product is switched on when the LED (B) is lit.
  - b) The product is switched off when the LED (B) is out.
2. See *Troubleshooting on page 29* if the warning indicator (C) is lit or flashes.

**To do a check of the power trigger lockout**

The power trigger lockout is designed to prevent accidental operation. When you release the handle, the power trigger and the power trigger lockout both move back to their original positions.

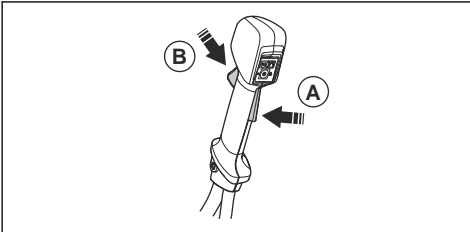

1. Make sure that the power trigger is locked when the lock is in its original position.

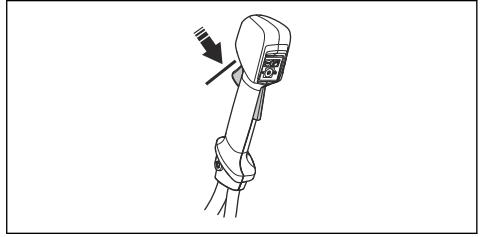

2. Press the power trigger and make sure it returns to its original position when you release it.

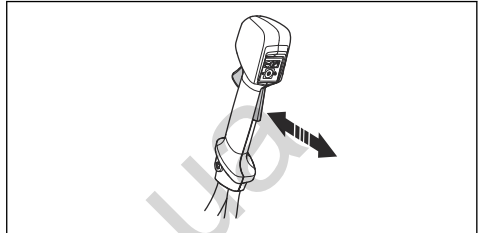

3. Make sure that the power trigger and the lock moves freely and that the return spring works properly.

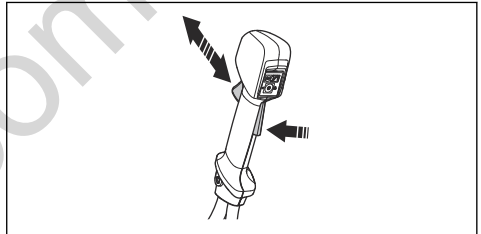

4. Start the product, see *To start the product on page 24*.
5. Apply full throttle.
6. Release the power trigger and make sure that the cutting attachment stops and remains still.

**To do a check of the cutting attachment guard**



**WARNING:** Do not use a cutting attachment without an approved and correctly attached cutting attachment guard. Always use the recommended cutting attachment guard for the

cutting attachment that you use, see *Product overview on page 2*. If an incorrect or faulty cutting attachment guard is attached this can cause serious personal injury.

The cutting attachment guard stops objects that ejects in the direction of the operator. It also prevents injuries that occur if you touch the cutting attachment.

1. Stop the motor.
2. Do a visual check for damages, for example cracks.

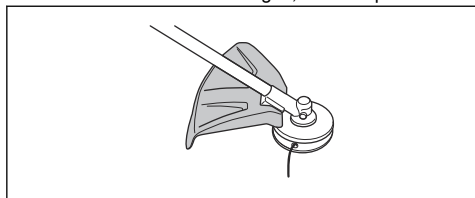

3. Replace the cutting attachment guard if it is damaged.

#### To do a check of the locknut

 **WARNING:** Stop the motor, use protective gloves and be careful around the sharp edges of the cutting attachment.

- Make sure that the locknut is attached and tightened correctly. See *To attach and remove the locknut on page 21*.

#### Quick release function of the harness

 **WARNING:** Do not use the harness if the quick release function is defective. Make sure that the quick release function operates

correctly when you adjust the product.



**WARNING:** If the product is not safely attached to the harness, you can not control the product and that can result in injury to you or others.

The quick release function is at the front of the harness. The harness straps must always stay at the correct position.

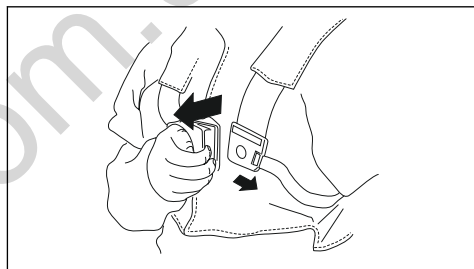

In an emergency, the quick release function helps you to remove the product safely.

#### Battery safety



**WARNING:** Read the warning instructions that follow before you use the product.

- Only use the BLi battery. Refer to *Accessories on page 32*. The battery is software encrypted.

- Use the BLi battery that is rechargeable as a power supply for the related Husqvarna products only. To prevent injury, do not use the battery as a power supply for other devices.
- Risk of electrical shock. Do not connect the battery terminals to keys, coins, screws or other metal. This can cause a short circuit of the battery.
- Do not use non-rechargeable batteries.
- Do not put objects into the air slots of the battery.
- Keep the battery away from sunlight, heat or open flame. The battery can cause burns and/or chemical burns.
- Keep the battery away from microwaves and high pressure.
- Do not try to disassemble or break the battery.
- If the battery leaks, do not let the liquid touch your body or eyes. If you have touched the liquid, clean the area with a large quantity of water and soap, and get medical aid. If you get liquid in your eyes, do not rub but flush with water

- for a minimum of 15 minutes and get medical aid.
- Use the battery in temperatures between -10 °C (14 °F) and 40 °C (114 °F).
- Do not clean the battery or the battery charger with water. Refer to *To clean the product, the battery and the battery charger on page 28*.
- Do not use a defective or damaged battery.
- Keep batteries in storage away from metal objects such as nails, screws or jewelry.
- Keep the battery away from children.

### Battery charger safety

---



**WARNING:** Read the warning instructions that follow before you use the product.

---

- Risk of electrical shock or short circuit if the safety instructions are not obeyed.
- Do not use other battery chargers than the one supplied for your product. Only use QC chargers when you charge BLi replacement batteries.
- Do not try to disassemble the battery charger.

- Do not use a defective or damaged battery charger.
- Do not lift the battery charger by the power cord. To disconnect the battery charger from a mains socket, pull out the plug. Do not pull the power cord.
- Keep all cables and extension leads away from water, oil and sharp edges. Make sure that the cable is not caught between objects, for example, doors, fences or equivalent.
- Do not use the battery charger near flammable materials or materials that can cause corrosion. Make sure that the battery charger is not covered. Pull out the plug to the battery charger if there is smoke or fire.
- Only charge the battery indoors in a location with good airflow and away from sunlight. Do not charge the battery outdoors. Do not charge the battery in wet conditions.
- Only use the battery charger where the temperature is between 5 °C (41 °F) and 40 °C (104 °F). Use the charger in an environment which has a good airflow, dry and free from dust.
- Do not put objects into the cooling slots of the battery charger.
- Do not connect the battery charger terminals to metal objects as this can short circuit the battery charger.
- Use approved mains sockets that are not damaged. Make sure that the cord of the battery charger is not damaged. If extension cables are used, make sure that the extension cables are not damaged.

### Safety instructions for maintenance

---



**WARNING:** Read the warning instructions that follow before you do maintenance on the product.

---

- Remove the battery before you do maintenance, other checks or assemble the product.
- The operator must only do the maintenance and servicing shown in this operator's manual. Turn to your servicing dealer for

maintenance and servicing of a larger extension.

- Do not clean the battery or the battery charger with water. Strong detergent can cause damage to the plastic.
- If you do not do maintenance, it decreases the life cycle of the product and increases the risk of accidents.
- Special training is necessary for all servicing and repair

work, especially for the safety devices on the product. If not all checks in this operator's manual are approved after you have done maintenance, turn to your servicing dealer. We guarantee that there are professional repairs and servicing available for your product.

- Only use original spare parts.

---

## Assembly

---

### Introduction



**WARNING:** Read and understand the safety chapter before you assemble the product.

### To assemble the handlebar

1. Remove the knob and attach the handlebar as given in the illustration.

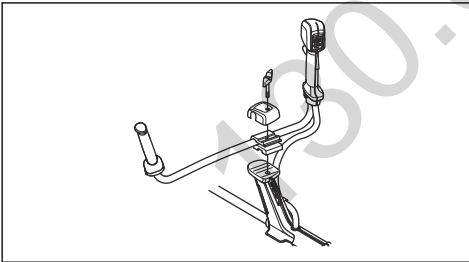

2. Tighten the knob lightly.
3. Put on the harness and hang the product from the suspension point.

4. Adjust the handle to put the product in a good work position.



5. Tighten the knob fully.

### To assemble the loop hanger

1. Push the lock piece (A) into the loop hanger.

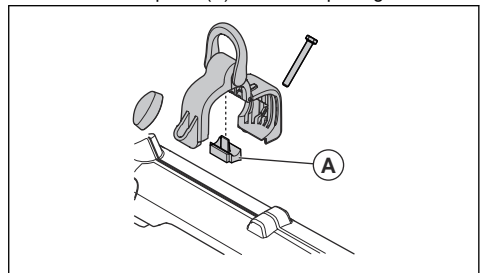

- Put the loop hanger on the shaft.

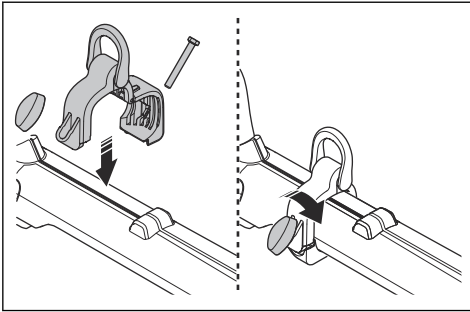

- Connect the ends of the loop hanger.
- Install the bolt.
- Put the knob on the bolt.
- Tighten the knob.

## To assemble the trimmer guard

- Install the correct trimmer guard for the trimmer head, refer to *Accessories on page 32*.
- Hang the trimmer guard on the hook on the plate holder (A).
- Bend the trimmer guard around the shaft and attach it with the bolt (B) on the opposite side of the shaft.

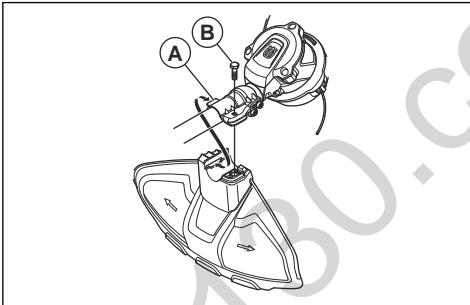

## To assemble the blade



**CAUTION:** Only use the approved blade guard for the blades. Refer to *Accessories on page 32*.

- Put the gear of the product on a flat surface to make sure that the blade is assembled correctly.

- Attach the blade guard (A) onto the shaft, refer to *To assemble the trimmer guard on page 21*.

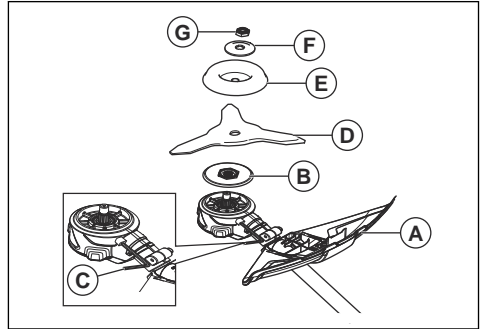

- Install the drive disc (B) on the output shaft.
- Turn the output shaft until one of the holes in the drive disc aligns with the related hole in the gear housing.
- Tighten the locking bolt (C) with the hex key to lock the shaft.
- Put the blade (D) and support cup (E) on the output shaft.
- Put the cup washer (F) on the output shaft.
- Install the nut (G). Hold the shaft of the wrench near the blade guard as much as possible. To tighten the nut, you must turn the wrench counterclockwise which is the opposite direction of rotation. Tighten the nut to a torque of 35-50 Nm (3.5-5 kpm).

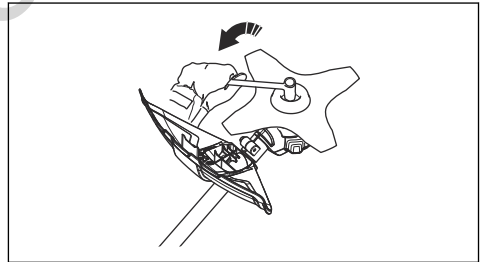

## To attach and remove the locknut



**WARNING:** Stop the engine, use protective gloves and be careful around the sharp edges of the cutting attachment.

A locknut is used to attach some types of cutting attachments. The locknut has a left thread.

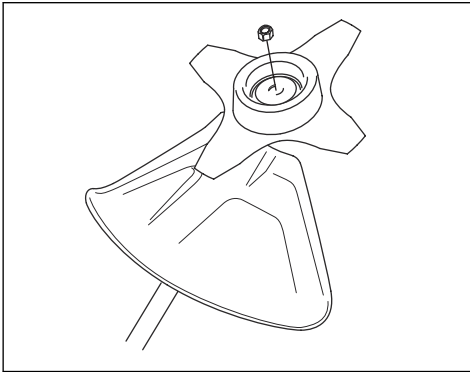

- To attach, tighten the lock nut in the opposite direction to the direction of rotation of the cutting attachment.
- To remove the locking nut, undo the lock nut in the same direction as the cutting attachment rotates.
- To loose and tighten the locknut, use a socket spanner with a long shaft. The arrow in the picture shows the area where you should operate the socket spanner.

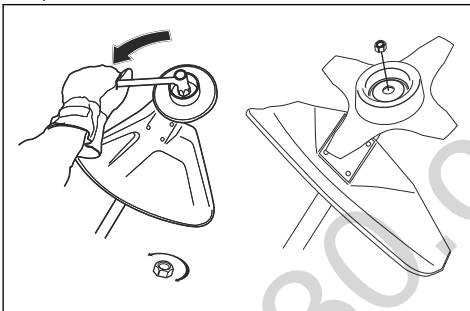

**WARNING:** When you loose and tighten the locknut there is a risk of injury from the teeth of the saw blade. You should

therefore always ensure that your hand is shielded by the blade guard when you do this.

**Note:** Make sure that you can not turn the locknut by hand. Replace the nut if the nylon lining does not have a resistance of a minimum of 1.5 Nm. The nut should be replaced after it has been put on approximately 10 times.

## To adjust the harness



**WARNING:** The product must always be correctly attached to the harness. Do not use a defective harness.

1. Put on the harness.
2. Connect the product to the harness.
3. Adjust the harness for the best work position.
4. Adjust the side straps to make the product weigh equally on your shoulders.



5. Adjust the harness until the cutting attachment is parallel to the ground.
6. Let the cutting attachment lightly touch the ground. Adjust the harness clamp to balance the product correctly.

**Note:** If you use a grass blade, it must balance approximately 10 cm / 4 in above the ground.

## Operation

### Introduction



**WARNING:** Read and understand the safety chapter before you use the product.

### To examine the product before operation

- Examine the motor for dirt and cracks. Use a brush to remove grass and leaves from the engine. Wear protective gloves when necessary.

- Make sure that the trimmer head is fully attached to the product.
- Do the safety inspections, maintenance and servicing that are given in this manual.
- Make sure that the product is not damaged. Examine that all nuts and screws are tight.

- Make sure that there are no cracks on the blade. Cracks usually occur when you make too sharp corners at the bottom of the teeth while you sharpen the blade. Cracks can also occur if you use the blade with blunt teeth. Replace the blade if it is damaged.

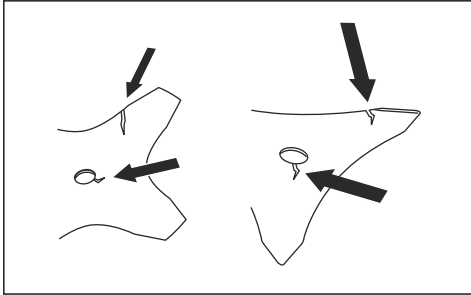

- Examine the support flange for cracks. Replace the support flange if it is damaged.

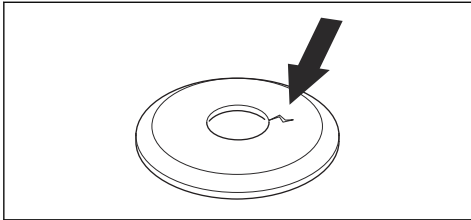

- Make sure that the locking force on the locknut is not decreased. The locknut must have a locking force at a minimum of 1.5 Nm. The tightening torque of the locknut must be between 35-50 Nm.

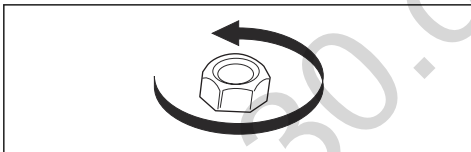

- Examine the blade guard for damages or cracks. Replace the blade guard if it has been hit or if it has cracks. Do not use the product without a guard or a defective guard.

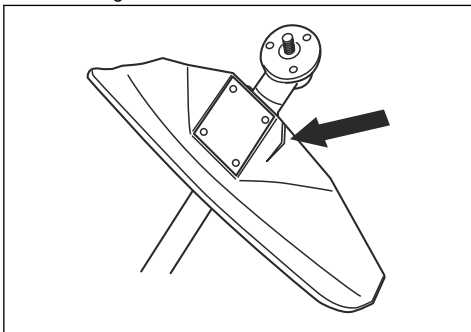

- Examine the trimmer head and cutting attachment guard for damages or cracks. Replace the trimmer head and cutting attachment guard if they have been hit or if they have cracks.

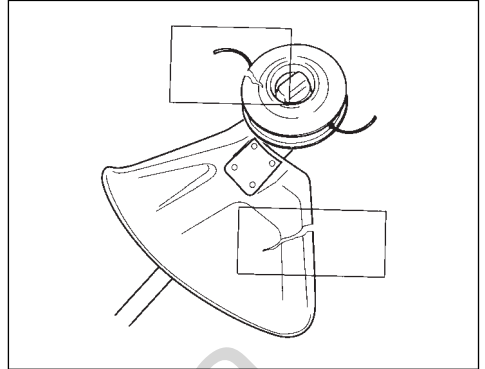

- Make sure that all covers, guards, handles and the cutting equipment are correctly attached and not damaged before you start the product.

### To connect the battery charger

1. Connect the battery charger to the voltage and frequency that is specified on the rating plate.
2. Put the plug in a grounded socket outlet. The LED on the battery charger flashes green one time.

**Note:** The battery does not charge if the battery temperature is more than 50 °C/122 °F. If the temperature is more than 50 °C/122 °F, the battery charger makes the battery become cool before the battery charges.

### To charge the battery

**Note:** Charge the battery if it is the first time that you use it. A new battery is only 30% charged.

1. Make sure that the battery is dry.
2. Put the battery in the battery charger.

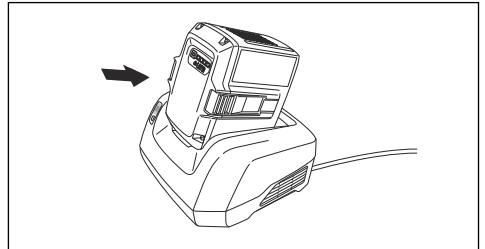



3. Make sure that the green charging light on the battery charger comes on. That means that the battery is connected correctly to the battery charger.

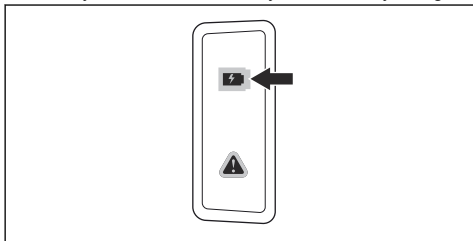

4. When all LEDs on the battery come on, the battery is fully charged.

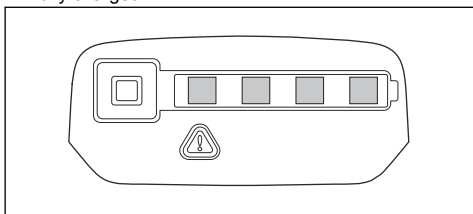

5. To disconnect the battery charger from the mains socket, pull the plug. Do not pull the cable.
6. Remove the battery from the battery charger.

**Note:** Refer to the battery and battery charger manuals for more information.

## To connect the battery to the product



**WARNING:** Only use Husqvarna original batteries with the product.

1. Make sure that the battery is fully charged.
2. Push the battery into the battery holder of the product. The battery locks into position when you hear a click.

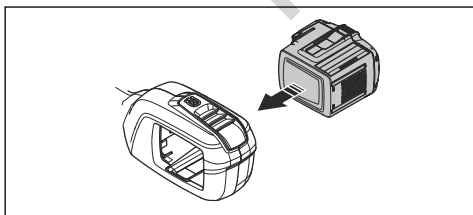

**CAUTION:** If the battery does not move easily into the battery holder, the battery is not installed correctly. This can cause damage to the product.

3. Make sure that the battery is installed correctly.

## Battery information

Refer to the operator's manual of the battery for information about how to use the battery.

## To start the product

**Note:** The product identifies the cutting attachment when the cutting attachment is changed, is started and the throttle is pressed. The product stops and the LED flashes until the throttle is released and moves back to its initial position. The cutting attachment is at this time identified and prepared for operation.

1. Press and hold the start button until the green LED is lit.

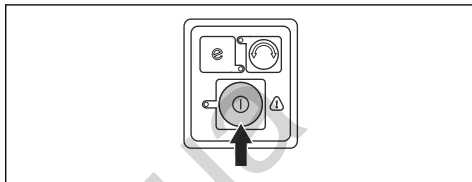

2. Use the power trigger to control the speed.

## To operate the product

### Automatic shutdown function

The product has a shutdown function that stops the product if the product is not used. The green LED for start/stop indication goes off and the product stops after 120 seconds.

### To start the SavE function

The product has a power saving function. The SavE function gives the longest operation time from the battery.

1. Push the SavE button to start the function. The green LED comes on to show that the function is on.

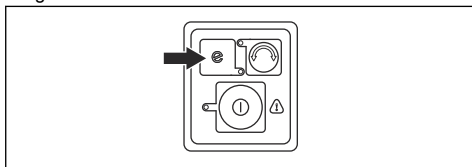

2. Push the SavE button again to stop the SavE function.

### To change the operation direction of the trimmer head

It is possible to change the operation direction of the trimmer head. This can be done at full speed or at stop position. In the factory, the trimmer head is set to turn clockwise. The green LED is off when the trimmer head turns clockwise.

1. Push the operation direction button to make the trimmer head turn counterclockwise. The green LED is on when the trimmer head turns counterclockwise.

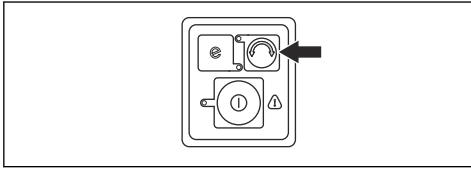

**Note:** It is easier to tap out the trimmer line to make it longer when the trimmer head turns clockwise.

### To loosen cut material from the grass blade/grass cutter

If a grass blade/grass cutter is used, the rotation direction is counterclockwise. A green LED shows that the grass blade/grass cutter rotates counterclockwise. Change rotation direction to clockwise to loosen the cut material from the grass blade/grass cutter.

1. Push the rotation direction button to change the rotation direction.

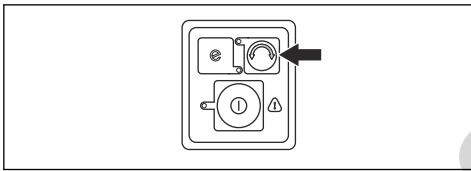

**Note:** When the rotation direction is changed to clockwise, cut material is loosened from the grass blade/grass cutter. The speed of the grass blade/grass cutter decreases for a short period of time before it rotates counterclockwise again.

### To balance the product

- Connect the harness to the support hook (A) or the loop hanger (B) on the product.

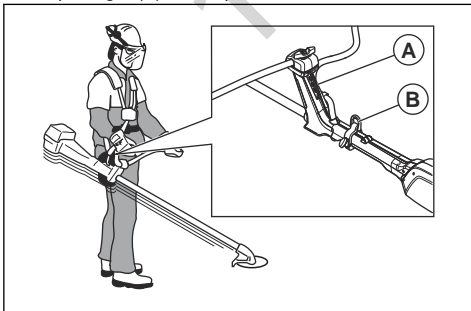

- Keep the cutting attachment parallel to the ground.
- The product is correctly balanced when the blade is at cutting height near the ground.

### To trim grass with a trimmer head

#### To trim the grass

1. Hold the trimmer head immediately above the ground at an angle. Do not push the trimmer line into the grass.

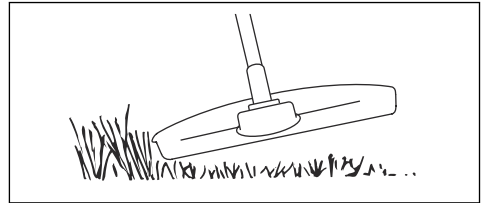

2. Decrease the length of the trimmer line by 10-12 cm / 4-4.75 in.
3. Decrease the engine speed to decrease the risk of damage to plants.
4. Use 80 % throttle when you cut grass near objects.



#### To clear grass

1. Keep the trimmer head above the ground.
2. Tilt the trimmer head.
3. Cut with the end of the trimmer line around objects in the work area.



**CAUTION:** Cut grass. Other objects that are hit by the trimmer line, increases the wear on the trimmer line.

4. Use 80% speed when you cut and clear vegetation. This decreases the wear on the trimmer head and trimmer line.

### To cut the grass

1. Make sure that the trimmer line is parallel to the ground when you cut the grass.

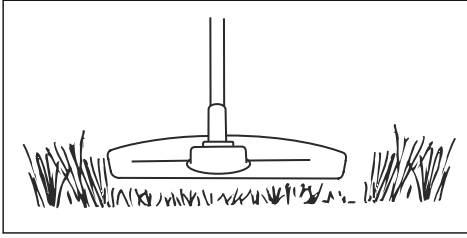

2. Do not push the trimmer head to the ground. This can cause damage to the product.
3. Move the product from side to side when you cut grass. Use full speed.

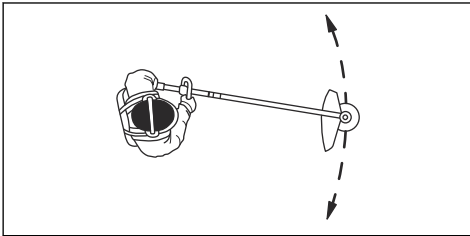

### To sweep the grass

The airflow from the rotating trimmer cord can be used to remove cut grass from an area.

1. Hold the trimmer head and its cord parallel to the ground and above the ground.
2. Apply full throttle.
3. Move the trimmer head from side to side and sweep the grass.



**WARNING:** Clean the trimmer head cover each time you assemble new trimmer cord to prevent unbalance and vibrations in the handles. Also do a check of the other parts of the trimmer head and clean it if necessary.

### To clear grass with a grass blade

1. Stand firmly with your feet apart.
2. Let the support cup rest lightly against the ground. Do this to protect the blade from hitting the ground.

3. Use a sideways swing movement from right to left to use the clear stroke and let the left side of the blade (between 8 and 12 o'clock) do the cutting.

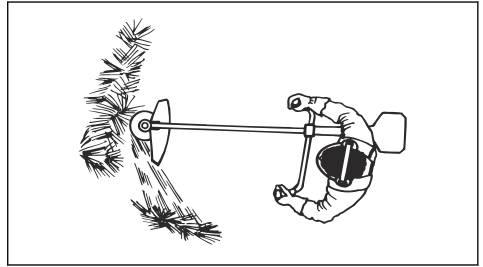

4. Angle the the blade to the left when you clear grass.

**Note:** The grass will collect in a line, which makes it easier to collect.

5. Use a sideways swing movement from left to right for the return stroke.
6. Do the work rhythmically.
7. Move forward and stand firmly again.
8. Stop the engine.
9. Remove the product from the clip on the harness.
10. Put the product on the ground.
11. Collect the cut material.

### To stop the product

1. Release the power trigger or the power trigger lockout.
2. Push the start/stop button until the green LED is off.
3. Push the release buttons on the battery and pull the battery out.

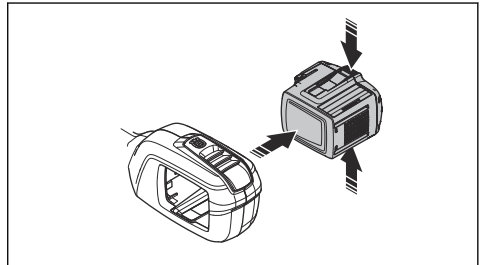

### To set the handlebar in transport position

1. Loosen the knob.
2. Turn the handlebar clockwise until the throttle handle touches the battery.

3. Turn the handlebar around the shaft.

4. Tighten the knob.

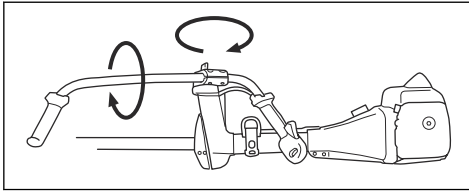

## Maintenance

### Introduction



**WARNING:** Read and understand the safety chapter before you do maintenance on the product.

The following is a list of the maintenance steps that you must do on the product. See *Maintenance on page 27* for more information.

### Maintenance schedule



**WARNING:** Remove the battery before you do maintenance.

Maintenance	Daily	Weekly	Monthly
Clean the external parts of the product with a dry cloth. Do not use water.	X		
Examine that the start and stop button works correctly and is not damaged.	X		
Make sure that the power trigger and the power trigger lockout function correctly from a safety point of view.	X		
Make sure that all controls work and are not damaged.	X		
Keep the handles dry, clean and free from oil and grease.	X		
Make sure that the cutting attachment is not damaged. Replace the cutting attachment if it is damaged.	X		
Make sure that the cutting attachment guard is not damaged. Replace the cutting attachment guard if it is damaged.	X		
Make sure that the screws and nuts are tight.	X		
Make sure that the battery release buttons on the battery works and locks the battery in the product.	X		
Examine that the battery charger is not damaged and function correctly.	X		
Make sure that the battery is not damaged.	X		
Make sure that the battery is charged.	X		
Make sure that the battery charger is not damaged.	X		
Examine all cables, couplings and connections. Make sure they are not damaged and free from dirt.		X	
Do a check of the connections between the battery and the product. Do a check of the connection between the battery and the battery charger.			X

## To examine the battery and the battery charger

1. Examine the battery for damages, for example cracks.
2. Examine the battery charger for damages, for example cracks.
3. Make sure that the connection cord of the battery charger is not damaged and that there are no cracks in it.

## To clean the product, the battery and the battery charger

1. Clean the product with a dry cloth after use.
2. Clean the battery and battery charger with a dry cloth. Keep the battery guide tracks clean.
3. Make sure that the terminals on the battery and the battery charger are clean before the battery is put in the battery charger or the product.

## To do a check of the trimmer line

Only use the recommended trimmer line. See the illustration on the last pages of the manual.

1. Put the cord into the hole on the cover of the product to make sure it follows the recommendation.

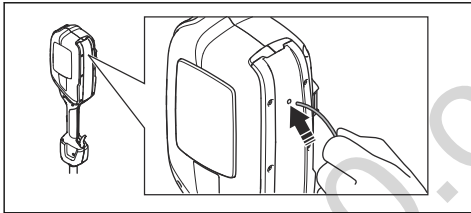

## To replace the trimmer head

**Note:** To increase the life of the cord it can be soaked in water for a couple of days before it is assembled. This will make the cord tougher.

1. Press the snap-in clips on the trimmer head and remove the trimmer head and trimmer line.

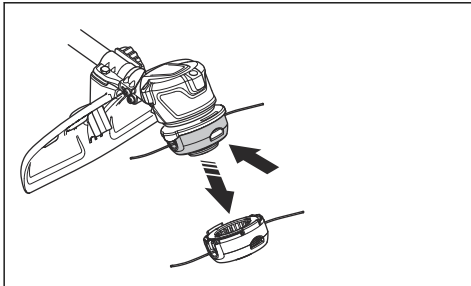

2. Pull out the line chute assembly.

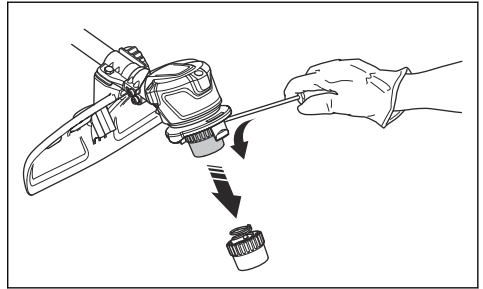

3. Remove the nut that holds the trimmer head and the drive disc.

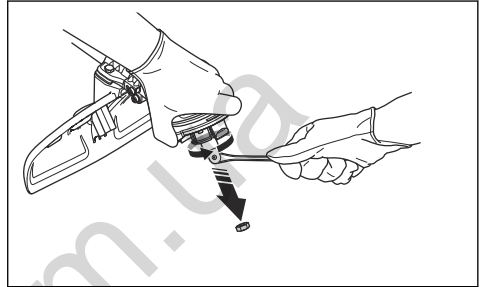

4. Replace the trimmer head.
5. Install the nut.
6. Install the line chute assembly.
7. Install the trimmer head.

## To sharpen the grass knife and grass blade



**WARNING:** Stop the product. Use protective gloves.



**WARNING:** Always discard a blade that is damaged. Do not try to make a bent or twisted blade straight and use it again.

- To sharpen the grass knife or grass blade correctly, refer to the instructions that come with the cutting attachment.
- Sharpen all edges equally to keep the balance.
- Use a single-cut flat file.

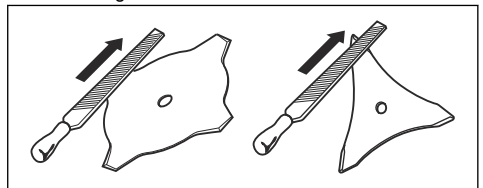

# Troubleshooting

## Keypad

LED display	Possible faults	Possible action
Green activate LED flashing.	Low battery voltage.	Charge the battery.
	Identifying the cutting tool.	Release the throttle.
Red error LED flashing.	The power trigger and the activate button are pressed at the same time.	Release the power trigger and the product is active.
	Overload.	The cutting attachment is jammed. deactivate the product.
		Remove the battery. Clean the cutting attachment from unwanted materials.
Temperature deviation.	Let the product cool down.	
The product does not start.	Dirt in the battery connectors.	Clean the battery connectors with compressed air or a soft brush.
Error LED is lit with red light.	The product needs servicing.	Contact your servicing agent.

## Battery

Problem	Possible faults	Possible solution
Green LED flashes.	Low battery voltage.	Charge the battery.
Red error LED flashes.	The battery is empty.	Charge the battery.
	Temperature deviation.	Use the battery in temperatures between -10°C (14°F) and 40°C (104°F).
	Overvoltage.	Remove the battery from the battery charger.
Red error LED comes on.	Cell difference is too much (1V).	Speak to your servicing dealer.

## Battery charger

LED display	Possible faults	Possible action
Error LED flashes	Temperature deviation.	Use the battery charger in temperatures between 5 °C (14 °F) and 40 °C (104 °F).
	Overvoltage.	Make sure that the mains voltage is the same as the shown voltage value on the rating plate on the product.  Remove the battery from the battery charger.
Error LED comes on		Speak to your service agent.

## Transportation, storage and disposal

### Transportation and storage

- The supplied Li-ion batteries obey the Dangerous Goods Legislation requirements.
- Obey the special requirement on package and labels for commercial transportation, including by third parties and forwarding agents.
- Speak to a person with special training in dangerous material before you send the product. Obey all applicable national regulations.
- Use tape on open contacts when you put the battery in a package. Put the battery in the package tightly to prevent movement.
- Remove the battery for storage or transportation.
- Put the battery and the battery charger in a space that is dry and free from moisture and frost.
- Do not keep the battery in an area where static electricity can occur. Do not keep the battery in a metal box.
- Put the battery in storage where the temperature is between 5 °C (41 °F) and 25 °C (77 °F) and away from open sunlight.
- Put the battery charger in storage where the temperature is between 5 °C (41 °F) and 45 °C (113 °F) and away from open sunlight.

- Charge the battery 30% to 50% before you put it in storage for long periods.
- Put the battery charger in storage in a space that is closed and dry.
- Keep the battery away from the battery charger during storage. Do not let children and other not approved persons to touch the equipment. Keep the equipment in a space that you can lock.
- Clean the product and do a full servicing before you put the product in storage for a long time.
- Use the transportation guard on the product to prevent injuries or damage on the product during transportation and storage.
- Attach the product safely during transportation.

### Disposal of the battery, battery charger and product

The symbol below means that the product is not domestic waste. Recycle it at a recycling station for

electrical and electronic equipment. This helps to prevent damage to the environment and to persons.

Speak to local authorities, domestic waste service or your dealer for more information.

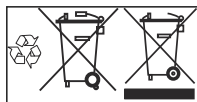

**Note:** The symbol shows on the product or package of the product.

## Technical data

### Technical data

	<b>520iRX</b>
<b>Motor</b>	
Motor type	BLDC (brushless) 36 V
Speed of output shaft, rpm	5500
Cutting width, mm	400
<b>Weight</b>	
Weight without battery, kg	3.8
Weight with battery, kg	5.1
<b>Water protection level</b>	
IPX4 <sup>1</sup>	Yes
<b>Noise emissions<sup>2</sup></b>	
Sound power level, measured dB (A)	92
Sound power level, guaranteed L <sub>WA</sub> dB (A)	96
<b>Noise levels<sup>3</sup></b>	
Equivalent sound pressure level at the operator's ear, measured according to EN ISO 60335-2-91 and ISO 22868, dB (A):	82
<b>Vibration levels<sup>4</sup></b>	
Vibration levels at handles, measured according to ISO 22867, m/s <sup>2</sup>	
Equipped with trimmer head (original), left/right	1.2/0.7
Equipped with grass blade (original), left/right	2.8/1.6

<sup>1</sup> The Husqvarna Handheld Battery products marked with IPX4 fulfils these requirements on product approval level

<sup>2</sup> Noise emissions in the environment measured as sound power (L<sub>WA</sub>) in conformity with EC directive 2000/14/EC. The difference between guaranteed and measured sound power is that the guaranteed sound power also includes dispersion in the measurement result and the variations between different machines of the same model according to Directive 2000/14/EC.

<sup>3</sup> Reported data for equivalent sound pressure level for the product has a typical statistical dispersion (standard deviation) of 3 dB (A).

<sup>4</sup> Reported data for vibration level has a typical statistical dispersion (standard deviation) of 2 m/s<sup>2</sup>.



## Approved batteries

Only use original BLi batteries for this product.

## Approved battery chargers

Battery charger	QC330	QC500
Input voltage, V	100-240	100-240
Frequency, Hz	50-60	50-60
Power, W	330	500

---

## Accessories

---

## Approved accessories

Approved accessory	Type	Cutting attachment guard, No	Article number
Trimmer head	T25B (Ø 2.0 mm - Ø 2.4 mm Whisper line)	577 01 83-03	
Grass blade/Grass cutter	Grass blade 255-4 (Ø 255 4-teeth)	577 01 83-03	
	Grass blade 255-3 (Ø 255 3 teeth)	577 01 83-03	
Loop hanger			590 28 23-01

---

# EC Declaration of Conformity

---

## EC Declaration of conformity

Husqvarna AB, SE-561 82 Huskvarna, Sweden, tel: +46-36-146500, declare that the battery trimmer

Husqvarna 520iRX with serial numbers dating from 2016 onwards (the year is clearly stated on the rating plate, followed by the serial number), comply with the requirements of the COUNCIL'S DIRECTIVE:

- of May 17, 2006 "relating to machinery" **2006/42/EC**.
- of February 26, 2014 "relating to electromagnetic compatibility" **2014/30/EU**.
- of May 8, 2000 "relating to the noise emissions in the environment" **2000/14/EC**.
- of June 8, 2011 on the "restriction of use of certain hazardous substances" **2011/65/EU**.

The following standards have been applied:

**EN 60335-1:2012+A11:2014, EN ISO 11806-1:2011, EN 55014-1:2006+A1:2009+A2:2011, EN 55014-2:2015, EN 50581:2012**

**SMP Svensk Maskinprovning AB**, Box 7035, SE-750 07 Uppsala, Sweden, has carried out EC type examination in accordance with the machinery directive's (2006/42/EC) article 12, point 3b.

SMP Svensk Maskinprovning AB has also verified agreement with appendix V of the council's directive 2000/14/EG. The certificate has the number: **01/1610/006**.

Intertek Semko AB, Box 1103, SE-164 22 Kista, Sweden has issued a voluntary type approval for Husqvarna AB.

For information relating to noise emissions, refer to *Technical data on page 31*.

Huskvarna 2018-09-28



Pär Martinsson, Development Manager (Authorized representative for Husqvarna AB and responsible for technical documentation.)

130.com.ua

# T25B



1

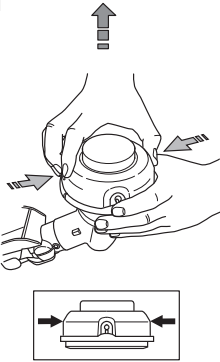

2

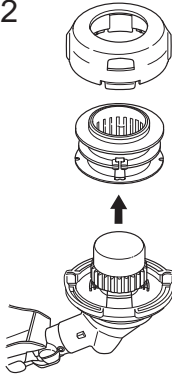

3

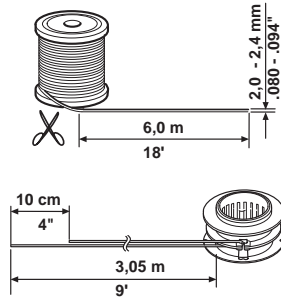

4

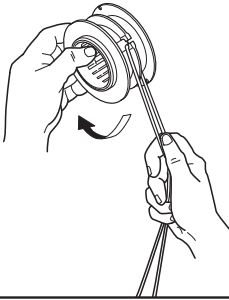

5

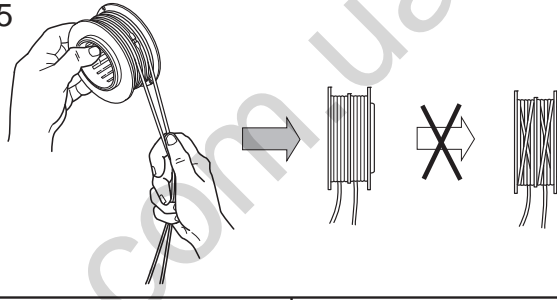

6

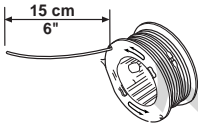

7

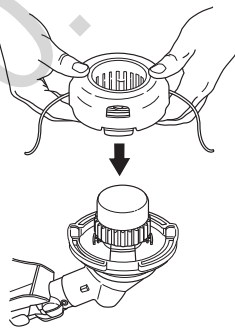

8

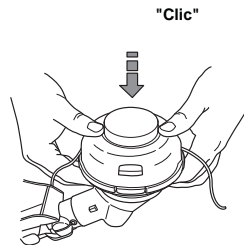

9

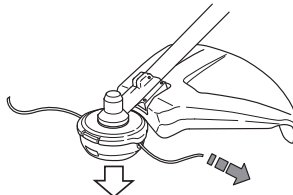



[www.husqvarna.com](http://www.husqvarna.com)

Original instructions

1140361-26



2018-11-02