



PHONES

0 (800) 800 130
(050) 462 0 130
(063) 462 0 130
(067) 462 0 130

130
COM.UA

Internet store of
autogoods



SKYPE

km-130

CAR RECEIVERS — Receivers • Media receivers and stations • Native receivers • CD/DVD changers • FM-modulators/USB adapters • Flash memory • Facia plates and adapters • Antennas • Accessories |
CAR AUDIO — Car audio speakers • Amplifiers • Subwoofers • Processors • Crossovers • Headphones • Accessories | TRIP COMPUTERS — Universal computers • Model computers • Accessories |
GPS NAVIGATORS — Portable GPS • Built-in GPS • GPS modules • GPS trackers • Antennas for GPS navigators • Accessories | VIDEO — DVR • TV sets and monitors • Car TV tuners • Cameras • Videomodules
• Transcoders • Car TV antennas • Accessories | SECURITY SYSTEMS — Car alarms • Bike alarms • Mechanical blockers • Immobilizers • Sensors • Accessories | OPTIC AND LIGHT — Xenon • Bixenon • Lamps
• LED • Stroboscopes • Optic and Headlights • Washers • Light, rain sensors • Accessories | PARKTRONICS AND MIRRORS — Rear parktronic • Front parktronic • Combined parktronic • Rear-view mirrors
• Accessories | HEATING AND COOLING — Seat heaters • Mirrors heaters • Screen-wipers heaters • Engine heaters • Auto-refrigerators • Air conditioning units • Accessories | TUNING — Vibro-isolation
• Noise-isolation • Tint films • Accessories | ACCESSORIES — Radar-detectors • Handsfree, Bluetooth • Windowlifters • Compressors • Beeps, loudspeakers • Measuring instruments • Cleaners • Car seats
• Miscellaneous | MOUNTING — Installation kits • Upholstery • Grilles • Tubes • Cable and wire • Tools • Miscellaneous | POWER — Batteries • Converters • Start-charging equipment • Capacitors
• Accessories | MARINE AUDIO AND ELECTRONICS — Marine receivers • Marine audio speakers • Marine subwoofers • Marine amplifiers • Accessories | CAR CARE PRODUCTS — Additives • Washer fluid •
Care accessories • Car polish • Flavors • Adhesives and sealants | LIQUID AND OIL — Motor oil • Transmission oil • Brake fluid • Antifreeze • Technical lubricant



In store "130" you can find and buy almost all necessary goods for your auto in Kyiv and other cities, delivery by ground and postal services. Our experienced consultants will provide you with exhaustive information and help you to choose the very particular thing. We are waiting for you at the address

<https://130.com.ua>



Operator's manual
418 EL 420 EL

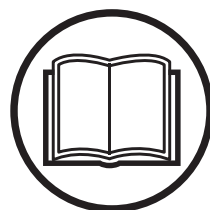

Please read the operator's manual carefully and make sure you understand the instructions before using the machine.

English

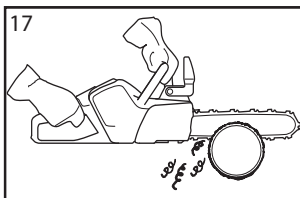
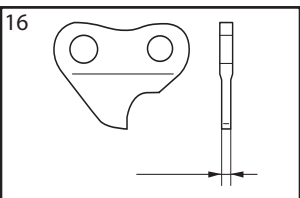
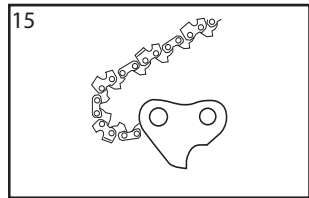
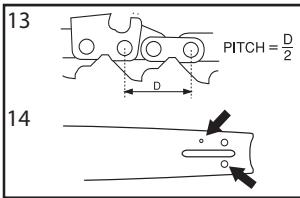
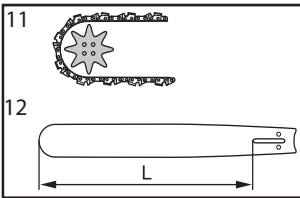
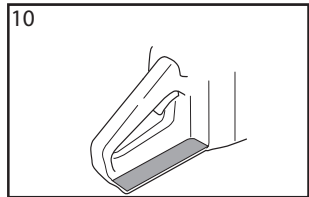
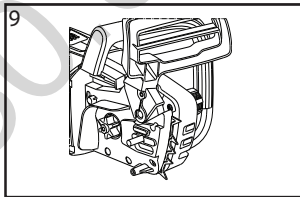
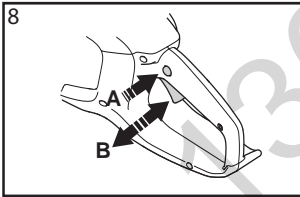
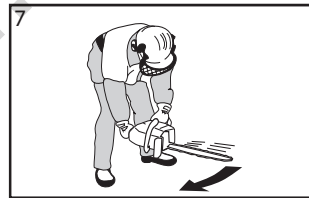
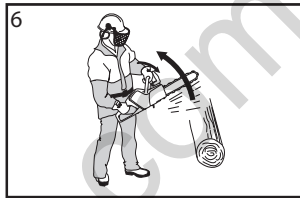
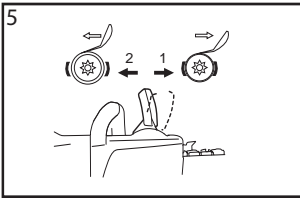
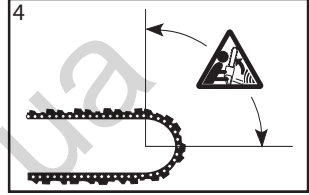
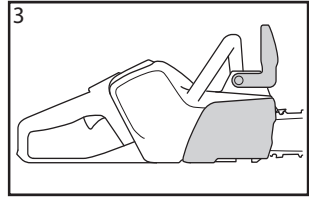
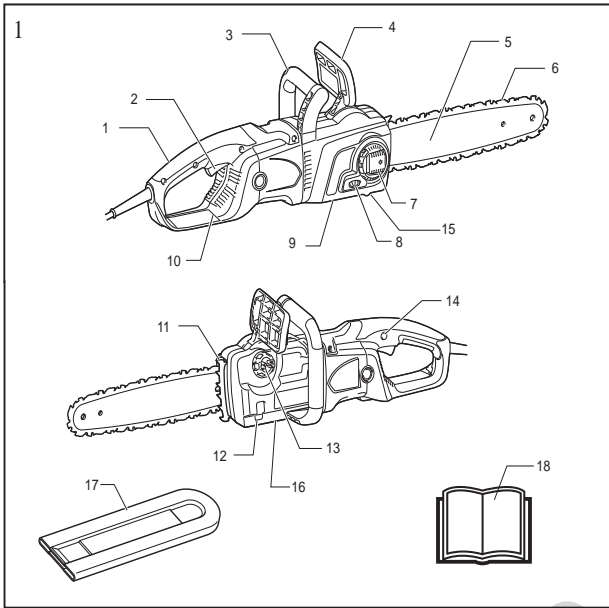

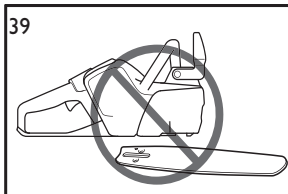
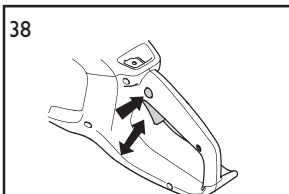
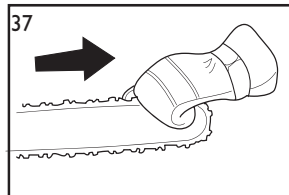
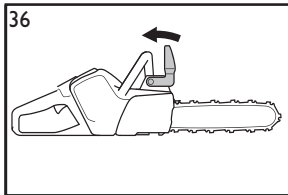
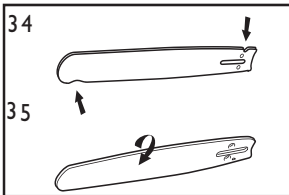
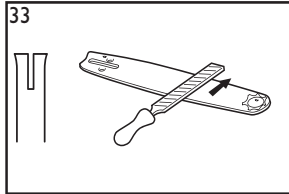
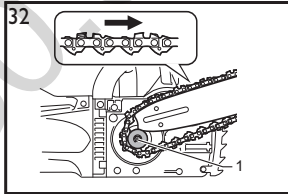
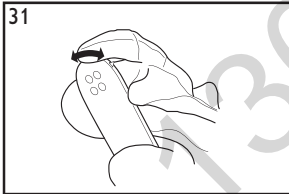
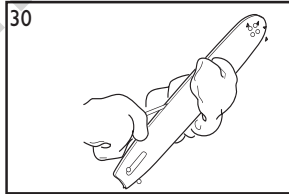
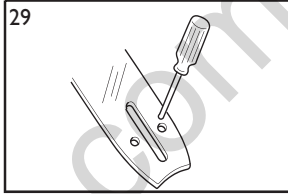
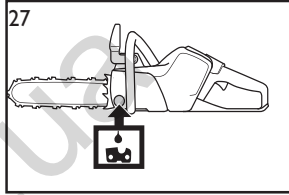
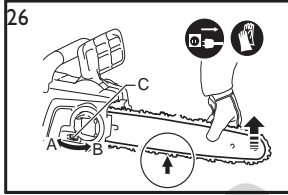
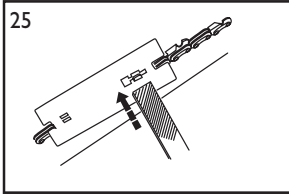
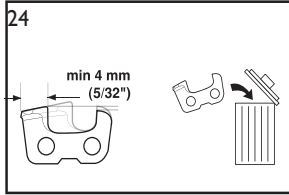
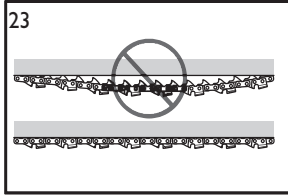
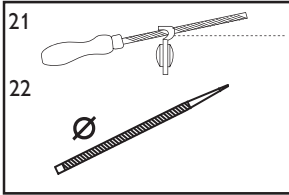
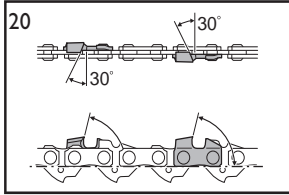
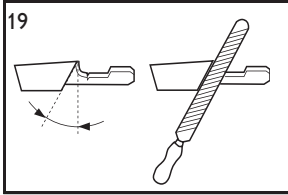
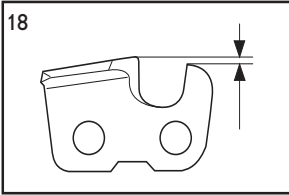

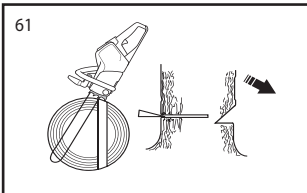
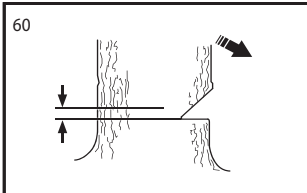
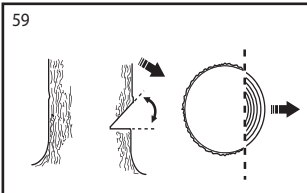
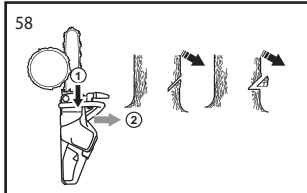
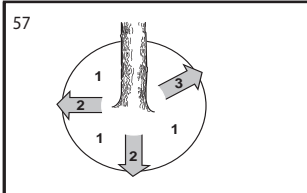
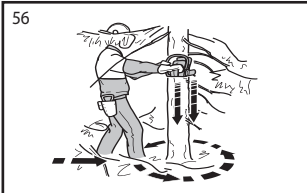
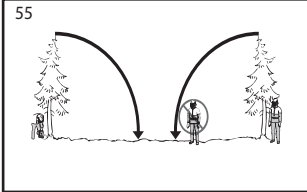
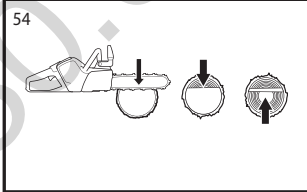
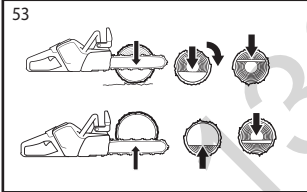
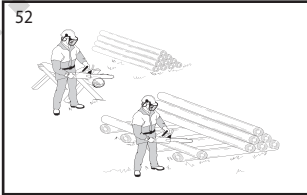
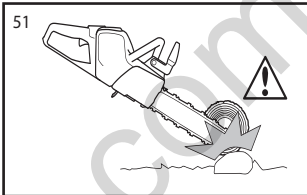
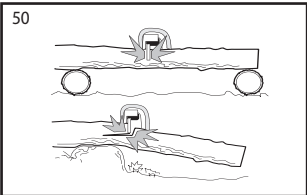
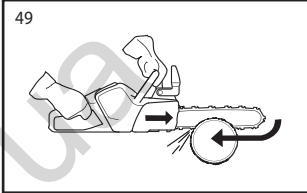
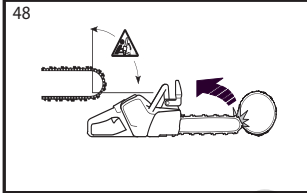
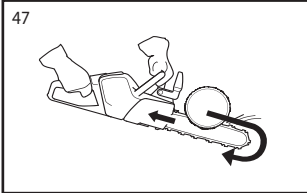
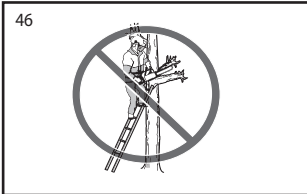
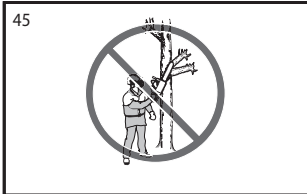
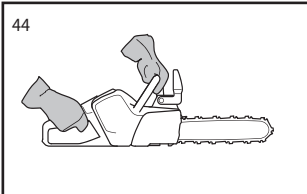
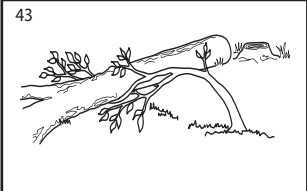
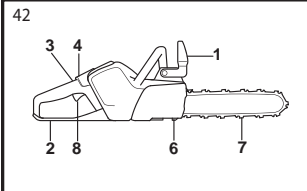

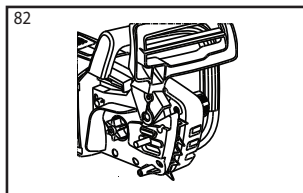
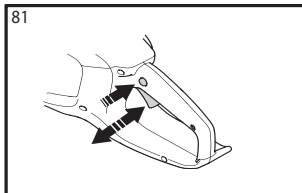
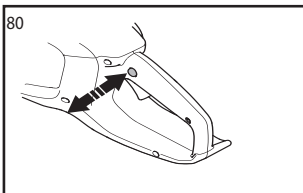
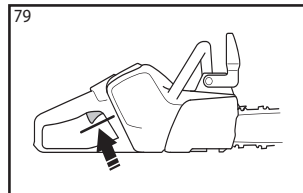
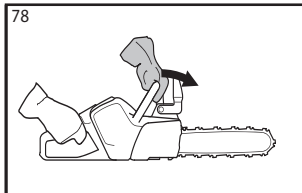
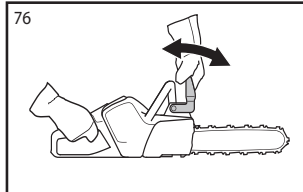
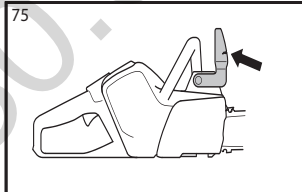
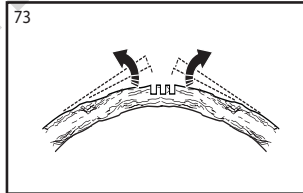
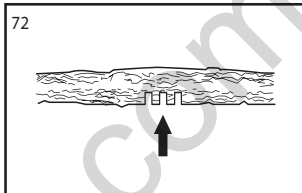
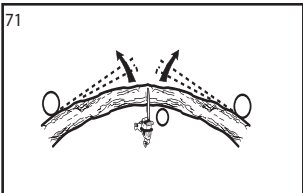
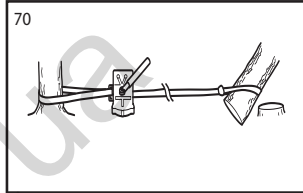
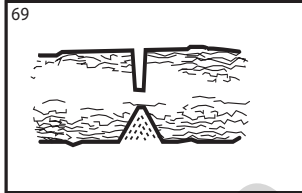
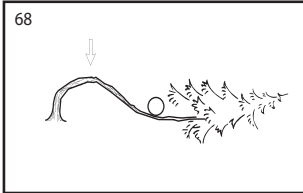
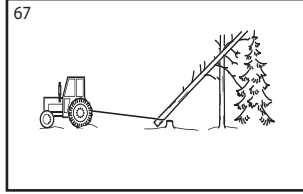
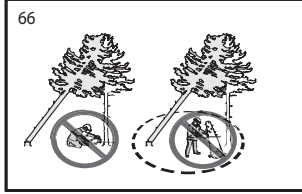
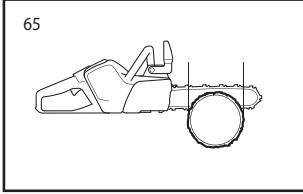
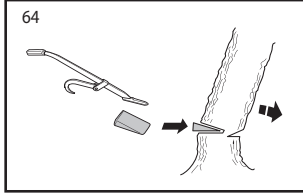
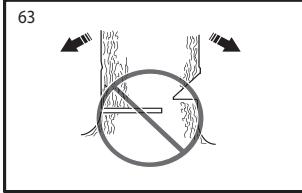
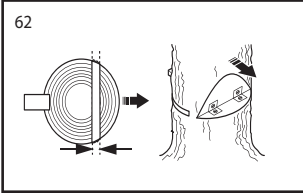

KEY TO SYMBOLS

Symbols on the machine:

Translation of the original Swedish operating instruction.

WARNING! Chain saws can be dangerous! Careless or incorrect use can result in serious or fatal injury to the operator or others.



Please read the operator's manual carefully and make sure you understand the instructions before using the machine.



Always wear:

- Approved protective helmet
- Hearing protection
- Protective goggles or a visor



This product is in accordance with applicable EC directives.



Noise emission to the environment according to the European Community's Directive. The machine's emission is specified in the Technical data chapter and on the label.



Both of the operator's hands must be used to operate the chain saw.



Never operate a chain saw holding it with one hand only.



Never let the guide bar tip come in contact with any object.



WARNING! Kickback may occur when the nose or tip of the guide bar touches an object, and cause a lightning fast reverse reaction, kicking the guide bar up and towards the operator. May cause serious personal injury.



Direction of rotation of the saw chain and maximum length of the guide bar.



Keep bystanders away.



Disconnect the plug before adjusting or cleaning.



Risk of electric shock.



Remove plug from power supply immediately if the cable is damaged or cut.



Chain brake, activated (right)
Chain brake, not activated (left)



Chain oil fill.



Environmental marking. Symbols on the product or its packaging indicate that this product cannot be handled as domestic waste. It must instead be submitted to an appropriate recycling station for the recovery of electrical and electronic equipment.



Do not expose to rain.



Double insulation



Other symbols/decals on the machine refer to special certification requirements for certain markets.

KEY TO SYMBOLS

Symbols in the operator's manual:

Always unplug the product from the power supply when assembling, checking and/or performing maintenance.



Always wear approved protective gloves.



Regular cleaning is required.

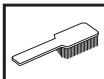

Visual check.



The chain brake must be engaged when the chain saw is started.



WARNING! Kickback may occur when the nose or tip of the guide bar touches an object, and cause a lightning fast reverse reaction, kicking the guide bar up and towards the operator. May cause serious personal injury.



Carton contents:

- Chainsaw
- Saw chain
- Guide bar
- Operator's manual
- Guide-bar cover

You will find the following decals on your machine.



CONTENTS

Contents

KEY TO SYMBOLS

Symbols on the machine:	6
Symbols in the operator's manual:	7
Carton contents:	7

CONTENTS

Contents	8
----------------	---

INTRODUCTION

Dear Customer,	9
----------------------	---

WHAT IS WHAT?

What is what on the chain saw?	9
--------------------------------------	---

GENERAL SAFETY PRECAUTIONS

General power tool safety warnings	10
Before using a new chain saw	12
Important	13
Always use common sense	13
Personal protective equipment	13
Machine's safety equipment	13
Chain brake and front hand guard	14
Cutting equipment	15

ASSEMBLY

Fitting the bar and chain	18
---------------------------------	----

STARTING AND STOPPING

Starting and stopping	19
-----------------------------	----

WORKING TECHNIQUES

Before use:	20
General working instructions	20
How to avoid kickback	23

MAINTENANCE

General	24
Checking, maintaining and servicing chain saw safety equipment	24
Lubricating the bar tip sprocket	24
Cooling system	24
Maintenance schedule	25

TECHNICAL DATA

Technical data	26
Guide bar and saw chain combinations	27
Saw chain filing and file gauges	27
EC Declaration of Conformity	27

INTRODUCTION

Dear Customer,

Congratulations on your choice to buy a Husqvarna product! Husqvarna is based on a tradition that dates back to 1689, when the Swedish King Karl XI ordered the construction of a factory on the banks of the Husqvarna River, for production of muskets. The location was logical, since water power was harnessed from the Husqvarna River to create the water-powered plant. During the more than 300 years in existence, the Husqvarna factory has produced a lot of different products, from wood stoves to modern kitchen appliances, sewing machines, bicycles, motorcycles etc. In 1956, the first motor driven lawn mowers appeared, followed by chain saws in 1959, and it is within this area Husqvarna is working today.

Today Husqvarna is one of the leading manufacturers in the world of forest and garden products, with quality as our highest priority. The business concept is to develop, manufacture and market motor-driven products for forestry and gardening, as well as for the building and construction industry. Husqvarna's aim is also to be at the front edge for ergonomics, usability, security and environmental protection. That is the reason why we have developed many different features to add to our products within these areas.

We are convinced that you will appreciate with great satisfaction the quality and performance of our product for a very long time to come. The purchase of one of our products gives you access to professional help with repairs and service whenever this may be necessary. If the retailer who sells your machine is not one of our authorized dealers, ask for the address of your nearest service workshop.

It is our wish that you will be satisfied with your product and that it will be your companion for a long time. Think of this operator's manual as a valuable document. By following its content (usage, service, maintenance, etc), the life span and the second-hand value of the machine can be extended. If you sell this machine, make sure that the operator's manual is passed on to the buyer.

Thank you for using a Husqvarna product.

Husqvarna AB has a policy of continuous product development and therefore reserves the right to modify the design and appearance of products without prior notice.

What is what on the chain saw? (1)

- 1 Rear handle
- 2 Power trigger
- 3 Front handle
- 4 Front hand guard
- 5 Guide bar
- 6 Saw chain
- 7 Knob
- 8 Adjusting screw/dial
- 9 Drive spocket cover
- 10 Rear hand guard
- 11 Spiked bumper
- 12 Oil level sight
- 13 Oil filler cap
- 14 Trigger lockout button
- 15 Chain catcher
- 16 Adjusting screw for oil pump
- 17 Guide-bar cover
- 18 Operator's manual

GENERAL SAFETY PRECAUTIONS

General power tool safety warnings



WARNING! Read all safety warnings and all instructions. Failure to follow the warnings and instructions may result in electric shock, fire and/or serious injury.

IMPORTANT! Save all warnings and instructions for future reference. The term "power tool" in the warnings refers to your mains-operated (corded) power tool or battery-operated (cordless) power tool.

Work area safety

- **Keep work area clean and well lit.** Cluttered or dark areas invite accidents.
- **Do not operate power tools in explosive atmospheres, such as in the presence of flammable liquids, gases or dust.** Power tools create sparks which may ignite the dust or fumes.
- **Keep children and bystanders away while operating a power tool.** Distractions can cause you to lose control.

Electrical safety

- **Power tool plugs must match the outlet. Never modify the plug in any way. Do not use any adapter plugs with earthed (grounded) power tools.** Unmodified plugs and matching outlets will reduce the risk of electric shock.
- **Avoid body contact with earthed or grounded surfaces, such as pipes, radiators, ranges and refrigerators.** There is an increased risk of electric shock if your body is earthed or grounded.
- **Do not expose power tools to rain or wet conditions.** Water entering a power tool will increase the risk of electric shock.
- **Do not abuse the cord. Never use the cord for carrying, pulling or unplugging the power tool. Keep cord away from heat, oil, sharp edges or moving parts.** Damaged or entangled cords increase the risk of electric shock.
- **When operating a power tool outdoors, use an extension cord suitable for outdoor use.** Use of a cord suitable for outdoor use reduces the risk of electric shock.
- **If operating a power tool in a damp location is unavoidable, use a residual current device (RCD) protected supply.** Use of an RCD reduces the risk of electric shock.

Personal safety

- **Stay alert, watch what you are doing and use common sense when operating a power tool. Do not use a power tool while you are tired or under**

the influence of drugs, alcohol or medication. A moment of inattention while operating power tools may result in serious personal injury.

- **Use personal protective equipment. Always wear eye protection.** Protective equipment such as dust mask, non-skid safety shoes, hard hat, or hearing protection used for appropriate conditions will reduce personal injuries.
- **Prevent unintentional starting. Ensure the switch is in the OFF-position before connecting to power source and/or battery pack, picking up or carrying the tool.** Carrying power tools with your finger on the switch or energising power tools that have the switch on invites accidents.
- **Remove any adjusting key or wrench before turning the power tool on.** A wrench or a key left attached to a rotating part of the power tool may result in personal injury.
- **Do not overreach. Keep proper footing and balance at all times.** This enables better control of the power tool in unexpected situations.
- **Dress properly. Do not wear loose clothing or jewellery. Keep your hair, clothing and gloves away from moving parts.** Loose clothes, jewellery or long hair can be caught in moving parts.
- **If devices are provided for the connection of dust extraction and collection facilities, ensure these are connected and properly used.** Use of dust collection can reduce dust-related hazards.

Power tool use and care

- **Do not force the power tool. Use the correct power tool for your application.** The correct power tool will do the job better and safer at the rate for which it was designed.
- **Do not use the power tool if the switch does not turn it on and off.** Any power tool that cannot be controlled with the switch is dangerous and must be repaired.
- **Disconnect the plug from the power source and/or the battery pack from the power tool before making any adjustments, changing accessories, or storing power tools.** Such preventive safety measures reduce the risk of starting the power tool accidentally.
- **Store idle power tools out of the reach of children and do not allow persons unfamiliar with the power tool or these instructions to operate the power tool.** Power tools are dangerous in the hands of untrained users.
- **Maintain power tools. Check for misalignment or binding of moving parts, breakage of parts and any other condition that may affect the power tool's operation. If damaged, have the power tool repaired before use.** Many accidents are caused by poorly maintained power tools.

GENERAL SAFETY PRECAUTIONS

- **Keep cutting tools sharp and clean.** Properly maintained cutting tools with sharp cutting edges are less likely to bind and are easier to control.
- **Use the power tool, accessories and tool bits etc. in accordance with these instructions, taking into account the working conditions and the work to be performed.** Use of the power tool for operations different from those intended could result in a hazardous situation.

Service

- **Have your power tool serviced by a qualified repair person using only identical replacement parts.** This will ensure that the safety of the power tool is maintained.

Chain saw safety warnings

- **Keep all parts of the body away from the saw chain when the chain saw is operating. Before you start the chain saw, make sure the saw chain is not contacting anything.** A moment of inattention while operating chain saws may cause entanglement of you clothing or body with the saw chain.
- **Always hold the chain saw with your right hand on the rear handle and your left hand on the front handle.** Holding the chain saw with a reversed hand configuration increases the risk of personal injury and should never be done.
- **Hold the power tool by insulated gripping surface only, because the saw chain may contact hidden wiring or its own cord.** Saw chain contacting a "live" wire may make exposed metal parts of the power tool "live" and could give the operator an electric shock.
- **Wear safety glasses and hearing protection. Further protective equipment for head, hands, legs and feet is recommended.** Adequate protective clothing will reduce personal injury by flying debris or accidental contact with the saw chain.
- **Do not operate a chain saw in a tree.** Operation of chain saw while up a tree may result in personal injury.
- **Always keep proper footing and operate the chain saw only when standing on fixed, secure and level surface.** Slippery or unstable surfaces such as ladders may cause a loss of balance or control of the chain saw.
- **When cutting a limb that is under tension be alert for spring back.** When the tension in the wood fibres is released the spring loaded limb may strike the operator and/or throw the chain saw out of control.
- **Use extreme caution when cutting brush and saplings.** The slender material may catch the saw chain and be whipped forward toward you or pull you off balance.
- **Carry the chain saw by the front handle with the chain saw switched off and away from your body. When transporting or storing the chain saw always fit the guide bar cover.** Proper handling of

the chain saw will reduce the likelihood of accidental contact with the moving saw chain.

- **Follow instruction for lubricating, chain tensioning and changing accessories.** Improperly tensioned or lubricated saw chain may either brake or increase the chance of kickback.
- **Keep handles dry, clean and free from oil and grease.** Greasy, oily handles are slippery causing loss of control.
- **Cut wood only. Do not use chain saw for purposes not intended. For example: do not use chain saw for cutting plastic, masonry or nonwood building materials.** Use of the chain saw for operations different than intended could result in a hazardous situation.
- We strongly recommend that first time users practice sawing logs on a saw horse or cradle.

Causes and operator prevention of kickback

- Kickback may occur when the nose or tip of the guide bar touches an object, or when the wood closes in and pinches the saw chain in the cut. Tip contact in some cases may cause a sudden reverse reaction, kicking the guide bar up and back towards the operator. Pinching the saw chain along the top of the guide bar may push the guide bar rapidly back towards the operator. Either of these reactions may cause you to lose control of the saw which could result in serious personal injury. Do not rely exclusively upon the safety devices built into your saw. As a chain saw user, you should take several steps to keep your cutting jobs free from accident or injury. Kickback is a result of tool misuse and/or incorrect operating procedures or conditions and can be avoided by taking proper precautions as given below:
- **Maintain a firm grip, with thumbs and fingers encircling the chain saw handles, with both hands on the saw and position your body and arm to allow you to resist kickback forces.** Kickback forces can be controlled by the operator, if proper precautions are taken. Do not let go of the chain saw.
- **Do not overreach and do not cut above shoulder height.** This helps prevent unintended tip contact and enables better control of the chain saw in unexpected situations.
- **Only use replacement bars and chains specified by the manufacturer.** Incorrect replacement bars and chains may cause chain breakage and/or kickback.
- **Follow the manufacturer's sharpening and maintenance instructions for the saw chain.** Decreasing the depth gauge height can lead to increased kickback.

GENERAL SAFETY PRECAUTIONS

Electrical safety

- It is recommended that you use a Residual Current Device (RCD) with a tripping current of not more than 30mA. Even with a RCD installed 100% safety cannot be guaranteed and safe working practice must be followed at all times. Check your RCD every time you use it.
- Before use, examine the cable for signs of damage or ageing. If the cable is found to be defective, take the product to an Authorized Service Center and have the cable replaced.
- Do not use the product if the electric cables are damaged or worn.
- Immediately disconnect from the mains electricity supply if the cable is cut, or the insulation is damaged. Do not touch the electric cable until the electrical supply has been disconnected. Do not repair a cut or damaged cable. Take the product to an Authorised Service Centre and have the cable replaced with a genuine spare cable.
- Always make sure that the cable/extension cord is kept behind the user, ensuring that it does not create a source of danger for the user or for other persons, and check that it cannot be damaged (by heat, sharp objects, sharp edges, oil, etc);
- Position the cable so that it will not be caught on branches and the like, during cutting.
- Always switch off at the mains before disconnecting any plug, cable connector or extension cable.
- Switch off, remove plug from the mains and examine electric cable for damage or ageing before winding cable for storage. Do not repair a damaged cable. Take the product to an Authorised Service Centre and have the cable replaced.
- Remove the plug from the mains before leaving the product unattended for any period.
- Always wind cable carefully, avoiding kinking.
- Use only on AC mains voltage shown on the product rating label.
- The chainsaw is double insulated to EN60745-1 & 2-13.
- **Make sure your extension cord is in good condition.** Inspect extension cord before use and replace if damaged. Do not use a damaged cord. Cord insulation must be intact with no cracks or deterioration. Plug connectors must be undamaged. Damaged extension cords increase the risk of electric shock.
- **Residual Current Device (RCD) protection should be provided on circuit or outlet to be used.** Receptacles are available having built-in RCD protection and may be used for this measure of safety. Inspect chain saw cords periodically and if damaged, have repaired by an authorized service dealer.

Cables

- Extension cables are available from your local Approved Service Centre.
- Only use approved extension cables.
- Extension cables and leads should only be used if they are designed for outdoor use and comply with H07 RN-F or IEC 60245 designation 66.

Before using a new chain saw

- Please read this manual carefully.
- Fill with chain oil. See instructions under the heading Filling with chain oil.
- Do not use the chain saw until sufficient chain oil has reached the chain. See instructions under the heading Lubricating cutting equipment.
- Check that the cutting equipment is correctly fitted and adjusted. See instructions under the heading Assembly.
- Long-term exposure to noise can result in permanent hearing impairment. So always use approved hearing protection.
- This saw is intended for use between the temperatures of -20°C (-4°F) and +40°C (104°F).



WARNING! Under no circumstances may the design of the machine be modified without the permission of the manufacturer. Always use original accessories. Non-authorized modifications and/or accessories can result in serious personal injury or the death of the operator or others.



WARNING! A chain saw is a dangerous tool if used carelessly or incorrectly and can cause serious, even fatal injuries. It is very important that you read and understand the contents of this operator's manual.



WARNING! This machine produces an electromagnetic field during operation. This field may under some circumstances interfere with active or passive medical implants. To reduce the risk of serious or fatal injury, we recommend persons with medical implants to consult their physician and the medical implant manufacturer before operating this machine.



WARNING! Long term inhalation of chain oil mist and dust from sawdust can represent a health risk.

GENERAL SAFETY PRECAUTIONS

Important

IMPORTANT!

This chain saw for tree service is designed for pruning and dismantling standing tree crowns.

You should only use the saw with the bar and chain combinations we recommend in the chapter Technical data.

Never use the machine if you are fatigued, while under the influence of alcohol or drugs, medication or anything that could affect your vision, alertness, coordination or judgement.

Wear personal protective equipment. See instructions under the "Personal protective equipment" heading.

Do not modify this product or use it if it appears to have been modified by others.

Never use a machine, battery or battery charger that is faulty. Carry out the checks, maintenance and service instructions described in this manual. Some maintenance and service measures must be carried out by trained and qualified specialists. See instructions under the heading Maintenance.

Never use any accessories other than those recommended in this manual. See instructions under the headings Cutting equipment and Technical data.

CAUTION! Always wear protective glasses or a face visor to reduce the risk of injury from thrown objects. A chain saw is capable of throwing objects, such as wood chips, small pieces of wood, etc, at great force. This can result in serious injury, especially to the eyes.



WARNING! Faulty cutting equipment or the wrong combination of bar and saw chain increases the risk of kickback! Only use the bar/saw chain combinations we recommend, and follow the filing instructions. See instructions under the heading Technical data.

Always use common sense

It is not possible to cover every conceivable situation you can face when using a chain saw. Always exercise care and use your common sense. Avoid all situations which you consider to be beyond your capability. (2) If you still feel uncertain about operating procedures after reading these instructions, you should consult an expert before continuing. Do not hesitate to contact your dealer or us if you have any questions about the use of the chain saw. We will willingly be of service and provide you with advice as well as help you to use your chain saw both efficiently and safely. Attend a training course in chain saw usage if possible. Your dealer, forestry school or your library can provide information about which training materials and courses are available.

Work is constantly in progress to improve the design and technology - improvements that increase your safety and efficiency. Visit your dealer regularly to see whether you can benefit from new features that have been introduced.

Personal protective equipment



WARNING! Most chain saw accidents happen when the chain touches the operator. You must use approved personal protective equipment whenever you use the machine. Personal protective equipment cannot eliminate the risk of injury but it will reduce the degree of injury if an accident does happen. Ask your dealer for help in choosing the right equipment.

Always wear:

- Approved protective helmet
- Hearing protection
- Protective goggles or a visor
- Gloves with saw protection
- Trousers with saw protection
- Use appropriate protections for arm.
- Boots with saw protection, steel toe-cap and non-slip sole
- Always have a first aid kit nearby.
- Fire Extinguisher and Shovel

Generally clothes should be close-fitting without restricting your freedom of movement.

IMPORTANT! Sparks can come from the bar and chain or other sources. Always have fire extinguishing tools available if you should need them. Help prevent forest fires.



WARNING! Working in a tree requires the use of special cutting and working techniques which must be observed in order to reduce the increased risk of personal injury.

Machine's safety equipment

In this section the machine's safety features and their function are explained. For inspection and maintenance see instructions under the heading Checking, maintaining and servicing chain saw safety equipment. See instructions under the heading, What is what?, to find where these parts are located on your machine.

The life span of the machine can be reduced and the risk of accidents can increase if machine maintenance is not carried out correctly and if service and/or repairs are not

GENERAL SAFETY PRECAUTIONS

carried out professionally. If you need further information please contact your nearest service workshop.



WARNING! Never use a machine with defective safety components. Safety equipment must be inspected and maintained. See instructions under the heading Checking, maintaining and servicing chain saw safety equipment. If your machine does not pass all the checks, take the saw to a servicing dealer for repair.

Chain brake and front hand guard

Your chain saw is equipped with a chain brake that is designed to stop the chain if you get a kickback. The chain brake reduces the risk of accidents, but only you can prevent them. (3)

Take care when using your saw and make sure the kickback zone of the bar never touches any object. (4)

- The chain brake can be activated manually (by your left hand).
- The brake is applied when the front hand guard is pushed forward.
- This movement activates a spring-loaded mechanism that stops the drive sprocket.
- The front hand guard is not designed solely to activate the chain brake. Another important feature is that it reduces the risk of your left hand hitting the chain if you lose grip of the front handle.
- To release the chain brake pull the front hand guard backwards, towards the front handle.
- The chain brake must be engaged when the chain saw is started.
- Use the chain brake as a "parking brake" when starting and when moving over short distances, to reduce the risk of moving chain accidentally hitting your leg or anyone or anything close by. (5)
- Kickback can be very sudden and violent. Most kickbacks are minor and do not always activate the chain brake. If this happens you should hold the chain saw firmly and not let go.
- The way the chain brake is activated manually depends on the force of the kickback and the position of the chain saw in relation to the object that the kickback zone of the bar strikes.
- If the kickback is less violent or the kickback zone of the bar is closer to you the chain brake will be activated manually by the movement of your left hand. (6)
- In the felling position the left hand is in a position that makes manual activation of the chain brake impossible. With this type of grip, that is when the left hand is placed so that it cannot affect the movement of the front hand guard, the chain brake can only be activated by the inertia action. (7)

Will my hand always activate the chain brake during a kickback?

No. It takes a certain force to move the hand guard forward. If your hand only lightly touches the front guard or slips over it, the force may not be enough to trigger the chain brake. You should also maintain a firm grip of the chain saw handles while working. If you do and experience a kickback, your hand may never leave the front handle and will not activate the chain brake, or the chain brake will only activate after the saw has swung around a considerable distance. In such instances, the chain brake might not have enough time to stop the saw chain before it touches you.

There are also certain positions in which your hand cannot reach the front hand guard to activate the chain brake; for example, when the saw chain is held in felling position.

Will my inertia activated chain brake always activate during kickback in the event of a kickback?

No. First your brake must be in working order. Second the kickback must be strong enough to activate the chain brake. If the chain brake is too sensitive it would activate all the time which would be a nuisance.

Will my chain brake always protect me from injury in the event of a kickback?

No. First, the chain brake must be in working order to provide the intended protection. Second, it must be activated during the kickback as described above to stop the saw chain. Third, the chain brake may be activated but if the bar is too close to you the brake might not have enough time to slow down and stop the chain before the chain saw hits you.

Only you and proper working technique can eliminate kickback and its danger.

Power trigger lockout

The power trigger lockout is designed to prevent accidental operation of the power trigger. When you press the power trigger lockout (A) (i.e. when you grasp the handle) it releases the power trigger (B). When you release the handle the power trigger and the power trigger lockout both move back to their original positions. (8)

Chain catcher

The chain catcher is designed to catch the chain if it snaps or jumps off. This should not happen if the chain is properly tensioned (see instructions under the heading Assembly) and if the bar and chain are properly serviced and maintained (see instructions under the heading General working instructions). (9)

GENERAL SAFETY PRECAUTIONS

Right hand guard

Apart from protecting your hand if the chain jumps or snaps, the right hand guard stops branches and twigs from interfering with your grip on the rear handle. (10)

Vibrations

Cutting hardwoods (most broadleaf trees) creates more vibration than cutting softwoods (most conifers). Cutting with cutting equipment that is blunt or faulty (wrong type or badly sharpened) will increase the vibration level.



WARNING! Under no circumstances may the design of the machine be modified without the permission of the manufacturer. Always use original accessories. Non-authorized modifications and/or accessories can result in serious personal injury or the death of the operator or others.



WARNING! Overexposure to vibration can lead to circulatory damage or nerve damage in people who have impaired circulation. Contact your doctor if you experience symptoms of overexposure to vibration. Such symptoms include numbness, loss of feeling, tingling, pricking, pain, loss of strength, changes in skin colour or condition. These symptoms normally appear in the fingers, hands or wrists. These symptoms may be increased in cold temperatures.

Cutting equipment

This section describes how to choose and maintain your cutting equipment in order to:

- Reduce the risk of kickback.
- Reduce the risk of the saw chain breaking or jumping off the bar.
- Obtain optimal cutting performance.
- Extend the life of cutting equipment.
- Avoid increasing vibration levels.

General rules

- **Only use cutting equipment recommended by us!** See instructions under the heading Technical data.
- **Keep the chain's cutting teeth properly sharpened! Follow our instructions and use the recommended file gauge.** A damaged or badly sharpened chain increases the risk of accidents.
- **Maintain the correct depth gauge setting! Follow our instructions and use the recommended depth gauge clearance.** Too large a clearance increases the risk of kickback. (18)
- **Keep the chain properly tensioned!** If the chain is slack it is more likely to jump off and lead to increased wear on the bar, chain and drive sprocket. (23)

- **Keep cutting equipment well lubricated and properly maintained!** A poorly lubricated chain is more likely to break and lead to increased wear on the bar, chain and drive sprocket.

Cutting equipment designed to reduce kickback



WARNING! Faulty cutting equipment or the wrong combination of bar and saw chain increases the risk of kickback! Only use the bar/saw chain combinations we recommend, and follow the filing instructions. See instructions under the heading Technical data.

The only way to avoid kickback is to make sure that the kickback zone of the bar never touches anything.

By using cutting equipment with "built-in" kickback reduction and keeping the chain sharp and well-maintained you can reduce the effects of kickback.

Guide bar

The smaller the tip radius the lower the chance of kickback.

Saw chain

A chain is made up of a number of links, which are available in standard and low-kickback versions.

IMPORTANT! No saw chain design eliminates the danger of kickback.



WARNING! Any contact with a rotating saw chain can cause extremely serious injuries.

Some terms that describe the bar and chain

To maintain the safety features of the cutting equipment, you should replace a worn or damaged bar or chain with a bar and chain combinations recommended by Husqvarna. See instructions under the heading Technical Data for a list of replacement bar and chain combinations we recommend.

Guide bar

- Length (inches/cm) (12)
- Number of teeth on bar tip sprocket (T). (11)
- Chain pitch (inches). The spacing between the drive links of the chain must match the spacing of the teeth on the bar tip sprocket and drive sprocket. (13)
- Number of drive links. The number of drive links is determined by the length of the bar, the chain pitch and the number of teeth on the bar tip sprocket. (15)
- Bar groove width (inches/mm). The groove in the bar must match the width of the chain drive links.
- Chain oil hole and hole for chain tensioner. The bar must be matched to the chain saw design. (14)

Saw chain

- Chain pitch (inches) (13)

GENERAL SAFETY PRECAUTIONS

- Drive link width (mm/inches) (16)
- Number of drive links. (15)

Sharpening your chain and adjusting depth gauge setting



WARNING! Always wear gloves, when working with the chain.

General information on sharpening cutting teeth

- Never use a blunt chain. When the chain is blunt you have to exert more pressure to force the bar through the wood and the chips will be very small. If the chain is very blunt it will produce wood powder and no chips or shavings.
- A sharp chain eats its way through the wood and produces long, thick chips or shavings. (17)

The cutting part of the chain is called the cutter and consists of a cutting tooth (A) and the depth gauge (B). The cutters cutting depth is determined by the difference in height between the two (depth gauge setting). (18)

When you sharpen a cutting tooth there are four important factors to remember.

- 1 Filing angle (19)
- 2 Cutting angle (20)
- 3 File position (21)
- 4 Round file diameter (22)

It is very difficult to sharpen a chain correctly without the right equipment. We recommend that you use our file gauge. This will help you obtain the maximum kickback reduction and cutting performance from your chain.

See instructions under the heading Technical data for information about sharpening your chain.



WARNING! Departure from the sharpening instructions considerably increases the risk of kickback.

Sharpening cutting teeth

To sharpen cutting teeth you will need a round file and a file gauge. See instructions under the heading Technical data for information on the size of file and gauge that are recommended for the chain fitted to your chain saw.

- Check that the chain is correctly tensioned. A slack chain will move sideways, making it more difficult to sharpen correctly. (23)
- Always file cutting teeth from the inside face. Reduce the pressure on the return stroke. File all the teeth on one side first, then turn the chain saw over and file the teeth on the other side. (19)
- File all the teeth to the same length. When the length of the cutting teeth is reduced to 4 mm (5/32") the chain is worn out and should be replaced.

General advice on adjusting depth gauge setting

When you sharpen the cutting tooth the depth gauge setting will decrease. To maintain optimal cutting performance the depth gauge has to be filed down to achieve the recommended depth gauge setting. See instructions under the heading Technical data to find the correct depth gauge setting for your particular chain. (24)



WARNING! The risk of kickback is increased if the depth gauge setting is too large!

Adjustment of depth gauge setting

- The cutting teeth should be newly sharpened before adjusting the depth gauge setting. We recommend that you adjust the depth gauge setting every third time you sharpen the cutting teeth. NOTE! This recommendation assumes that the length of the cutting teeth is not reduced excessively.
- You will need a flat file and a depth gauge tool. We recommend that you use our depth gauge tool to achieve the correct depth gauge setting and bevel for the depth gauge.
- Place the depth gauge tool over the chain. Detailed information regarding the use of the depth gauge tool, will be found on the package for the depth gauge tool. Use the flat file to file off the tip of the depth gauge that protrudes through the depth gauge tool. The depth gauge setting is correct when you no longer feel resistance as you draw the file along the depth gauge tool. (25)

Tensioning the chain



WARNING! A slack chain may jump off and cause serious or even fatal injury.



WARNING! Always unplug the product from the power supply when assembling, checking and/or performing maintenance.

The more you use a chain the longer it becomes. It is therefore important to adjust the chain regularly to take up the slack.

Check the chain tension every time you refill with saw chain oil. NOTE! A new chain has a running-in period during which you should check the tension more frequently.

Tension the chain as tightly as possible, but not so tight that you cannot pull it round freely by hand. (26)

- Release the knob by folding it out until it snaps open.
- Turn the knob anti clockwise to loosen the drive sprocket cover.
- Adjust the tension on the chain by turning the chain tensioner wheel down (+) for tighter tension and up (-) to loosen the tension. (A-B)
- Tighten the bar clutch by turning the knob clockwise.

GENERAL SAFETY PRECAUTIONS

- Fold the knob back in to lock the tensioning.

Lubricating cutting equipment



WARNING! Poor lubrication of cutting equipment may cause the chain to snap, which could lead to serious, even fatal injuries.

Chain oil

Chain oil must demonstrate good adhesion to the chain and also maintain its flow characteristics regardless of whether it is warm summer or cold winter weather.

Never use waste oil! Using waste oil can be dangerous to you and damage the machine and environment.

Filling with chain oil

- All our chain saws have an automatic chain lubrication system. On some models the oil flow is also adjustable. (27)
- A full reservoir is sufficient for 15 minutes of steady use.
- Never use waste oil. This results in damage to the oil pump, the bar and the chain.
- It is important to use oil of the right grade (suitable viscosity range) to suit the air temperature.
- In temperatures below 0°C (32°F) some oils become too viscous. This can overload the oil pump and result in damage to the oil pump components.
- Contact your service agent when choosing chain oil.

Checking chain lubrication

Aim the tip of the bar at a light coloured surface about 20 cm (8 inches) away. After 1 minute running at full throttle you should see a distinct line of oil on the light surface. (28)

If the chain lubrication is not working:

- Check that the oil channel in the bar is not obstructed. Clean if necessary. (29)
- Check that the groove in the edge of the bar is clean. Clean if necessary. (30)
- Check that the bar tip sprocket turns freely and that the lubricating hole in the tip sprocket is not blocked. Clean and lubricate if necessary. (31)

If the chain lubrication system is still not working after carrying out the above checks and associated measures you should contact your service agent.

Chain drive sprocket

The drive system is fitted with a drive sprocket. (32)

Regularly check the degree of wear on the drive sprocket. Replace if wear is excessive.

Checking wear on cutting equipment

Check the chain daily for:

- Visible cracks in rivets and links.

- Whether the chain is stiff.
- Whether rivets and links are badly worn.

Replace the saw chain if it exhibits any of the points above.

We recommend you compare the existing chain with a new chain to decide how badly the existing chain is worn.

When the length of the cutting teeth has worn down to only 4 mm the chain must be replaced.

Guide bar

Check regularly:

- Whether there are burrs on the edges of the bar. Remove these with a file if necessary. (33)
- Whether the groove in the bar has become badly worn. Replace the bar if necessary.
- Whether the tip of the bar is uneven or badly worn. If a hollow forms on the underside of the bar tip this is due to running with a slack chain. (34)
- To prolong the life of the bar you should turn it over daily. (35)



WARNING! Most chain saw accidents happen when the chain touches the operator.

Wear personal protective equipment. See instructions under the "Personal protective equipment" heading.

Do not tackle any job that you feel you are not adequately trained for. See instructions under the headings Personal protective equipment, How to avoid kickback, Cutting equipment and General working instructions.

Avoid situations where there is a risk of kickback. See instructions under the heading Machine's safety equipment.

Use the recommended protective equipment and check its condition. See instructions under the headings Technical data and General safety precautions.

Check that all the chain saw safety features are working. See instructions under the headings General working instructions and General safety precautions.

Never use a chain saw by holding it with one hand. A chain saw is not safely controlled with one hand. Always have a secure, firm grip around the handles with both hands.

Fitting the bar and chain

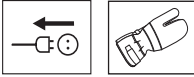

WARNING! Always wear gloves, when working with the chain.

- Check that the chain brake is in disengaged position by moving the front hand guard towards the front handle. **(36)**
- Remove the knob and remove the clutch cover (chain brake). Take off the transportation ring.
- Fit the bar over the bar bolt. Place the bar in its rearmost position. Place the chain over the drive sprocket and in the groove on the bar. Begin on the top side of the bar.
- Make sure that the edges of the cutting links are facing forward on the top edge of the bar.

Mount the clutch cover and remember to fit the chain adjuster pin in the hole in the bar. Check that the drive links of the chain fit correctly over the drive sprocket and that the chain is correctly located in the groove in the bar.

- Tension the chain by turning the wheel down (+). The chain should be tensioned until it does not sag from the underside of the bar.
- The chain is correctly tensioned when it does not sag from the underside of the bar, but can still be turned easily by hand. Hold up the bar tip and tighten the bar knob by turning the knob clockwise.
- When fitting a new chain, the chain tension has to be checked frequently until the chain is run-in. Check the chain tension regularly. A correctly tensioned chain ensures good cutting performance and long life. **(37)**

STARTING AND STOPPING

Starting and stopping



WARNING! Note the following before starting:

Never start a chain saw unless the bar, chain and all covers are fitted correctly. Otherwise the drive sprocket can come loose and cause personal injuries.

Make sure you have a secure footing and that the chain cannot touch anything.

Keep people and animals well away from the working area.

- Always check to see that the power trigger actuates properly and returns to the "OFF" position when released. To prevent the power trigger from being accidentally pulled, a power trigger lockout is provided. **(38)**
- Never start a chain saw unless the bar, chain and all covers are fitted correctly. **(39)** See instructions under the heading Assembly.
- Observe your surroundings and make sure that there is no risk of people or animals coming into contact with the cutting equipment. **(40)**
- Always hold the saw with both hands. The right hand should be on the rear handle, and the left hand on the front handle. All people, whether right or left handed, should use this grip. Use a firm grip with thumbs and fingers encircling the chain saw handles. **(41)**

Starting

- Grip the front handle with the left hand.
- Grip the rear handle with your right hand.
- Press and hold the power trigger lockout button with the inside of your hand and squeeze the power trigger with your index finger. **(38)**

Stopping

- Stop the saw by releasing the power trigger. If the saw does not stop, trip the chain brake and disconnect the power cable.

WORKING TECHNIQUES

Before use:

(42)

- 1 Check that the chain brake works correctly and is not damaged.
- 2 Check that the rear right hand guard is not damaged.
- 3 Check that the power trigger lockout works correctly and is not damaged.
- 4 Check that all handles are free from oil.
- 5 Check that all parts of the chain saw are tightened correctly and that they are not damaged or missing.
- 6 Check that the chain catcher is in place and not damaged.
- 7 Check the chain tension.
- 8 Check that the saw chain stops moving when the power trigger is released.

General working instructions

IMPORTANT!

This section describes basic safety rules for using a chain saw. This information is never a substitute for professional skills and experience. If you get into a situation where you feel unsafe, stop and seek expert advice. Contact your chain saw dealer, service agent or an experienced chain saw user. Do not attempt any task that you feel unsure of!

Before using a chain saw you must understand the effects of kickback and how to avoid them. See instructions under the heading How to avoid kickback.

Before using a chain saw you must understand the difference between cutting with the top and bottom edges of the bar. See instructions under the headings How to avoid kickback and Machine's safety equipment.

Wear personal protective equipment. See instructions under the "Personal protective equipment" heading.

Basic safety rules

- 1 Look around you:
 - To ensure that people, animals or other things cannot affect your control of the machine.
 - To make sure that none of the above might come within reach of your saw or be injured by falling trees.
 - If wearing hearing protection, beware of persons approaching during use of saw.

CAUTION! Follow the instructions above, but do not use a chain saw in a situation where you cannot call for help in case of an accident.

- 2 Do not use the machine in bad weather, such as dense fog, heavy rain, strong wind, intense cold, etc. Working in bad weather is tiring and often brings added risks, such as icy ground, lightning, unpredictable felling direction, etc.

- 3 If working in hot condition be aware of dehydration and drink fluids.
- 4 Take great care when removing small branches and avoid cutting bushes (i.e. cutting many small branches at the same time). Small branches can be grabbed by the chain and thrown back at you, causing serious injury.
- 5 Make sure you can move and stand safely. Check the area around you for possible obstacles (roots, rocks, branches, ditches, etc.) in case you have to move suddenly. Take great care when working on sloping ground.
- 6 Take great care when cutting a tree that is in tension. A tree that is in tension may spring back to its normal position before or after being cut. If you position yourself incorrectly or make the cut in the wrong place the tree may hit you or the machine and cause you to lose control. Both situations can cause serious personal injury. (43)
- 7 Before moving your chain saw deactivate it and lock the saw chain using the chain brake. Carry the chain saw with the bar and chain pointing backwards. Fit a guard to the bar before transporting the chain saw or carrying it for any distance.
- 8 When you put the chain saw on the ground, lock the saw chain using the chain brake and ensure you have a constant view of the machine. Switch the engine off before leaving your chain saw for any length of time.



WARNING! Sometimes chips get stuck in the drive system causing the saw chain to jam. Always deactivate the machine and unplug from the power supply before any cleaning.

General rules

- 1 If you understand what kickback is and how it happens then you can reduce or eliminate the element of surprise. By being prepared you reduce the risk. Kickback is usually quite mild, but it can sometimes be very sudden and violent.
- 2 Always hold the chain saw firmly with your right hand on the rear handle and your left hand on the front handle. Wrap your fingers and thumbs around the handles. You should use this grip whether you are right-handed or left-handed. This grip minimises the effect of kickback and lets you keep the chain saw under control. **Do not let go of the handles! (44)**
- 3 Most kickback accidents happen during limbing. Make sure you are standing firmly and that there is nothing in the way that might make you trip or lose your balance.

Lack of concentration can lead to kickback if the kickback zone of the bar accidentally touches a branch, nearby tree or some other object.

Have control over the workpiece. If the pieces you intend to cut are small and light, they can jam in the

WORKING TECHNIQUES

saw chain and be thrown towards you. Even if this does not need to be a danger, you may be surprised and lose control of the saw. Never saw stacked logs or branches without first separating them. Only saw one log or one piece at a time. Remove the cut pieces to keep your working area safe. (52)

- 4 **Never use the chain saw above shoulder height and try not to cut with the tip of the bar. Never use the chain saw one-handed!** (45)
- 5 You must have a steady stance in order to have full control over the chain saw. Never work standing on a ladder, in a tree or where you do not have firm ground to stand on. (46)
- 6 Always use a fast cutting speed, i.e. full throttle.
- 7 Take great care when you cut with the top edge of the bar, i.e. when cutting from the underside of the object. This is known as cutting on the push stroke. The chain tries to push the chain saw back towards the user. If the saw chain is jamming, the saw may be pushed back at you. (47)
- 8 Unless the user resists this pushing force there is a risk that the chain saw will move so far backwards that only the kickback zone of the bar is in contact with the tree, which will lead to a kickback. (48)

Cutting with the bottom edge of the bar, i.e. from the top of the object downwards, is known as cutting on the pull stroke. In this case the chain saw pulls itself towards the tree and the front edge of the chain saw body rests naturally on the trunk when cutting. Cutting on the pull stroke gives the operator better control over the chain saw and the position of the kickback zone. (49)
- 9 Follow the instructions on sharpening and maintaining your bar and chain. When you replace the bar and chain use only combinations that are recommended by us. See instructions under the headings Cutting equipment and Technical data.

Basic cutting technique



WARNING! Never use a chain saw by holding it with one hand. A chain saw is not safely controlled with one hand. Always have a secure, firm grip around the handles with both hands.

General

- Always use full throttle when cutting!
- Let go of the power trigger after every cut (running the motor for too long at full power without any load, i.e. without any resistance from the chain during cutting, can lead to serious damage to the motor).
- Cutting from above = Cutting on the pull stroke.
- Cutting from below = Cutting on the push stroke.

Cutting on the push stroke increases the risk of kickback. See instructions under the heading How to avoid kickback.

Terms

Limbing = Cutting branches off a felled tree.

Splitting = When the object you are cutting breaks off before the cut is complete.

There are five important factors you should consider before making a cut:

- 1 Make sure the cutting equipment will not jam in the cut. (50)
- 2 Make sure the object you are cutting will not split. (50)
- 3 Make sure the chain will not strike the ground or any other object during or after cutting. (51)
- 4 Is there a risk of kickback? (4)
- 5 Do the conditions and surrounding terrain affect how safely you can stand and move about?

Two factors decide whether the chain will jam or the object that you are cutting will split: the first is how the object is supported before and after cutting, and the second is whether it is in tension.

In most cases you can avoid these problems by cutting in two stages; from the top and from the bottom. You need to support the object so that it will not trap the chain or split during cutting.



WARNING! If the chain jams in the cut: stop the engine! Don't try to pull the chain saw free. If you do you may be injured by the chain when the chain saw suddenly breaks free. Use a lever to open up the cut and free the chain saw.

The following instructions describe how to handle the commonest situations you are likely to encounter when using a chain saw.

Cutting



WARNING! Never attempt to cut logs while they are in a pile or when a couple of logs are lying together. Such procedures drastically increase the risk of kickback which can result in a serious or fatal injury.

If you have a pile of logs, each log you attempt to cut should be removed from the pile, placed on a saw horse or runners and cut individually.

Remove the cut pieces from the cutting area. By leaving them in the cutting area, you increase the risk for inadvertently getting a kickback, as well as increasing the risk of losing your balance while working. (52)

The log is lying on the ground. There is little risk of the chain jamming or the object splitting. However there is a risk that the chain will touch the ground when you finish the cut.

WORKING TECHNIQUES

Cut all the way through the log from above. Avoid letting the chain touch the ground as you finish the cut. Maintain full throttle but be prepared for what might happen.

If it is possible (can you turn the log?) stop cutting about 2/3 of the way through the log.

Turn the log and finish the cut from the opposite side. (53)

The log is supported at one end. There is a high risk that it will split.

Start by cutting from below (about 1/3 of the way through).

Finish by cutting from above so that the two cuts meet. (53)

The log is supported at both ends. There is a high risk that the chain will jam.

Start by cutting from above (about 1/3 of the way through).

Finish by cutting from below so that the two cuts meet. (54)

Tree felling technique

IMPORTANT! It takes a lot of experience to fell a tree. Inexperienced users of chain saws should not fell trees. Do not attempt any task that you feel unsure of!

Safe distance

The safe distance between a tree that is to be felled and anyone else working nearby is at least 2 1/2 tree lengths. Make sure that no-one else is in this "risk zone" before or during felling. (55)

Felling direction

The aim is to fell the tree in a position where you can limb and cross-cut the log as easily as possible. You want it to fall in a location where you can stand and move about safely.

Once you have decided which way you want the tree to fall you must judge which way the tree would fall naturally.

Several factors affect this:

- Lean of the tree
- Bend
- Wind direction
- Arrangement of branches
- Weight of snow
- Obstacles within the reach of the tree: for example, other trees, power lines, roads and buildings.
- Look for signs of damage and rot in the stem, this makes it more probable that the tree will break and start to fall before you expect it to.

You may find you are forced to let the tree fall in its natural direction because it is impossible or dangerous to try to make it fall in the direction you first intended.

Another very important factor, which does not affect the felling direction but does affect your safety, is to make sure the tree has no damaged or dead branches that might break off and hit you during felling.

The main point to avoid is letting the tree fall onto another tree. It is very dangerous to remove a trapped tree and there is high accident risk. See instructions under the heading Freeing a tree that has fallen badly.

IMPORTANT! During critical felling operations, hearing protectors should be lifted immediately when sawing is completed so that sounds and warning signals can be heard.

Clearing the trunk and preparing your retreat

Delimb the stem up to shoulder height. It is safer to work from the top down and to have the tree between you and the saw. (56)

Remove any undergrowth from the base of the tree and check the area for obstacles (stones, branches, holes, etc.) so that you have a clear path of retreat when the tree starts to fall. Your path of retreat should be roughly 135 degrees away from the intended felling direction. (57)

- 1 Danger zone
- 2 Retreat path
- 3 Felling direction

Felling



WARNING! Unless you have special training we advise you not to fell trees with a diameter larger than the bar length of your saw!

Felling is done using three cuts. First you make the directional cuts, which consist of the top cut and the bottom cut, then you finish with the felling cut. By placing these cuts correctly you can control the felling direction very accurately.

Directional cuts

To make the directional cut you begin with the top cut. Aim using to the saw's felling direction mark (1) toward a goal further forward in the terrain, where you would like the tree to fall (2). Stand on the right-hand side of the tree, behind the saw, and cut with a pull stroke.

Next make the bottom cut so that it finishes exactly at the end of the top cut. (58)

The directional cuts should run 1/4 of the diameter through the trunk and the angle between the top cut and bottom cut should be 45°.

The line where the two cuts meet is called the directional cut line. This line should be perfectly horizontal and at right angles (90°) to the chosen felling direction. (59)

Felling cut

The felling cut is made from the opposite side of the tree and it must be perfectly horizontal. Stand on the left side of the tree and cut on the pull stroke.

Make the felling cut about 3-5 cm (1.5-2 inches) above the bottom directional cut. (60)

WORKING TECHNIQUES

Set the spiked bumper (if one is fitted) just behind the felling hinge. Use full throttle and advance the chain/bar slowly into the tree. Make sure the tree does not start to move in the opposite direction to your intended felling direction. Drive a wedge or breaking bar into the cut as soon as it is deep enough. (61)

Finish the felling cut parallel with the directional cut line so that the distance between them is at least 1/10 of the trunk diameter. The uncut section of the trunk is called the felling hinge.

The felling hinge controls the direction that the tree falls in. (62)

All control over the felling direction is lost if the felling hinge is too narrow or non-existent, or if the directional cuts and felling cut are badly placed. (63)

When the felling cut and directional cut are complete the tree should start to fall by itself or with the aid of a felling wedge or breaking bar. (64)

We recommend that you use a bar that is longer than the diameter of the tree, so that you can make the felling cut and directional cuts with single cutting strokes. See instructions under the heading Technical data section to find out which lengths of bar are recommended for your saw. (65)

There are methods for felling trees with a diameter larger than the bar length. However these methods involve a much greater risk that the kickback zone of the bar will come into contact with the tree. (4)

Freeing a tree that has fallen badly

Freeing a "trapped tree"

It is very dangerous to remove a trapped tree and there is high accident risk.

Never try to fell the tree that is trapped.

Never work in the risk zone of the hanging trapped tree. (66)

The safest method is to use a winch.

- Tractor-mounted (67)
- Portable (70)

Cutting trees and branches that are in tension

Preparations: Work out which side is in tension and where the point of maximum tension is (i.e. where it would break if it was bent even more).

Decide which is the safest way to release the tension and whether you are able to do it safely. In complicated situations the only safe method is to put aside your chain saw and use a winch.

General advice:

Position yourself so that you will be clear of the tree or branch when the tension is released. (71)

Make one or more cuts at or near the point of maximum tension. Make as many cuts of sufficient depth as necessary to reduce the tension and make the tree or branch break at the point of maximum tension. (69)

Never cut straight through a tree or branch that is in tension!

If you must cut across tree/limb, make two to three cuts, one inch apart, one to two inches deep. (72)

Continue to cut deeper until tree/limb bends and tension is released. (73)

Cut tree/limb from outside the bend, after tension has been released.

How to avoid kickback



WARNING! Kickback can happen very suddenly and violently; kicking the chain saw, bar and chain back at the user. If this happens when the chain is moving it can cause very serious, even fatal injuries. It is vital you understand what causes kickback and that you can avoid it by taking care and using the right working technique.

What is kickback?

The word kickback is used to describe the sudden reaction that causes the chain saw and bar to jump off an object when the upper quadrant of the tip of the bar, known as the kickback zone, touches an object. (4B)

Kickback always occurs in the cutting plane of the bar. Normally the chain saw and bar are thrown backwards and upwards towards the user. However, the chain saw may move in a different direction depending on the way it was being used when the kickback zone of the bar touched the object.

Kickback only occurs if the kickback zone of the bar touches an object. (4)

Limbing



WARNING! A majority of kickback accidents occur during limbing. Do not use the kickback zone of the guide bar. Be extremely cautious and avoid contacting the log, other limbs or objects with the nose of the guide bar. Be extremely cautious of limbs under tension. They can spring back toward you and cause loss of control resulting in injury.

Make sure that you can stand and move about safely. Work on the left side of the trunk. Work as close as possible to the chain saw for maximum control. If possible, let the weight of the chain saw rest on the trunk. (74)

Keep the trunk between you and the chain saw as you move along the trunk.

Cutting the trunk into logs

See instructions under the heading Basic cutting technique.

MAINTENANCE

General

The user must only carry out the maintenance and service work described in this Operator's Manual. More extensive work must be carried out by an authorized service workshop.

Checking, maintaining and servicing chain saw safety equipment



WARNING! Always unplug the chainsaw from the power supply before any assembly, maintenance and/or checking is done on the machine.

Note! All service and repair work on the machine demands special training. This is especially true of the machine's safety equipment. If your machine fails any of the checks described below we recommend that you take it to your service workshop.

Chain brake and front hand guard

Checking the front hand guard

- Make sure the front hand guard is not damaged and that there are no visible defects such as cracks. **(75)**
- Move the front hand guard forwards and back to make sure it moves freely and that it is securely anchored to the machine. **(76)**

Checking the inertia brake release

- Place the chain saw, deactivated, above a stump or other stable surface. Release the front handle and let the chain saw fall by its own weight, rotating around the rear handle towards the stump.

When the bar hits the stump the brake should be activated. (77)

Checking the brake trigger

- Activate the chain saw. Make sure the saw chain does not touch the ground or any other object. See instructions under the heading Starting and stopping.
- Grasp the chain saw firmly, wrapping your fingers and thumbs around the handles. **(44)**
- Apply full power and activate the chain brake by tilting your left wrist forward onto the front hand guard. Do not let go of the front handle. **The chain should stop immediately. (78)**

Power trigger lockout

- Make sure that the power trigger is locked at the idle setting when the power trigger lockout is released. **(79)**
- Press the power trigger lockout and make sure it returns to its original position when released. **(80)**

- Check that the power trigger and power trigger lockout move freely and that the return springs work properly. **(81)**
- Activate the chain saw and apply full power. Release the power trigger and check that the saw chain stops and remains stationary.

Chain catcher

- Check that the chain catcher is not damaged and is firmly attached to the body of the chain saw. **(82)**

Cooling system

To keep the working temperature as low as possible the machine is equipped with a cooling system.

The cooling system consists of:

- 1 Air intake (under the power trigger).
 - 2 A fan on the motor.
- Clean the cooling system with a brush once a week, more often in demanding conditions. A dirty or blocked cooling system results in overheating which causes damage to the machine.

MAINTENANCE

Maintenance schedule

The following is a list of the maintenance steps that must be performed on the machine. Most of the items are described in the Maintenance section.

Each use	Frequent	Occasional
Clean the outside of the machine.	File off any burrs from the edges of the bar.	
Check that the components of the power trigger work safely. (Power trigger lockout and power trigger.)		Empty the oil tank and clean the inside.
Clean the chain brake and check that it operates safely. Make sure that the chain catcher is undamaged, and replace it if necessary.		Blow through the product and battery cooling slots gently with compressed air.
The bar should be turned daily for more even wear. Check the lubrication hole in the bar, to be sure it is not clogged. Clean the bar groove.		
Check that the bar and chain are getting sufficient oil.		
Check the saw chain with regard to visible cracks in the rivets and links, whether the saw chain is stiff or whether the rivets and links are abnormally worn. Replace if necessary.		
Sharpen the chain and check its tension and condition. Check the drive sprocket for excessive wear and replace if necessary.		
Clean the machine's air inlet.		
Check that nuts and screws are tight.		

TECHNICAL DATA

Technical data

	418EL	420EL
Electric motor		
Type	Series AC Motor	Series AC Motor
Power	1800W	2000W
Voltage range	230-240V	230-240V
Lubrication system		
Type of oil pump	Automatic	Automatic
Oil tank capacity, litre	0,20	0,20
Weight		
Chainsaw without bar and chain, empty chain oil tank, kg	4.7	4.7
Noise emissions (see note 1)		
Sound power level, measured dB (A)	101,9	101,9
Sound power level, guaranteed L_{WA} dB (A)	103	103
Sound levels (see note 2)		
Equivalent sound pressure level at the operator's ear, dB(A)	90,8	90,8
Equivalent vibration levels, a h (see note 3)		
Front handle, m/s^2	5,2	5,2
Rear handle, m/s^2	3,9	3,9
Respective uncertainty K, m/s^2	1,5	1,5
Chain/bar		
Recommended bar lengths, inch/cm	14/35	16/40
Usable cutting length, inch/cm	12.5/32	14/35.5
Type of drive sprocket/number of teeth	Spur/6	Spur/6
Maximum chain speed, m/s	14.5	14.5

Note 1: Noise emissions in the environment measured as sound power (L_{WA}) in conformity with EC directive 2000/14/EC Annex V.

Note 2: Equivalent sound pressure level, according to ISO 22868, is calculated as the time-weighted energy total for different sound pressure levels under various working conditions. Typical statistical dispersion for equivalent sound pressure level is a standard deviation of 2,5 dB (A).

Note 3: Vibration level, according to EN 60745-2-13. Reported data for vibration level has a typical statistical dispersion (standard deviation) of 1,5 m/s^2 . Declared vibration data from measurements when the machine is fitted with a bar length and recommended chain type.



Warning! The vibration emission during actual use of the power tool can differ from the declared total value depending on the ways in which the tool is used. Operators should identify safety measures to protect themselves that are based on an estimation of exposure in the actual conditions of use (taking account of all parts of the operating cycle such as the times when the tool is switched off and when it is running idle in addition to the trigger).





TECHNICAL DATA

Guide bar and saw chain combinations

The following cutting attachments are approved for the models Husqvarna 418 EL and 420 EL..

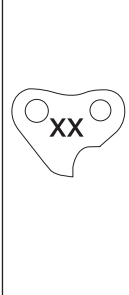
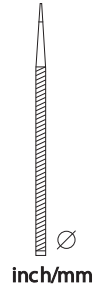
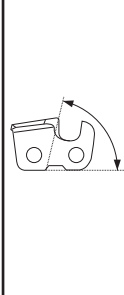
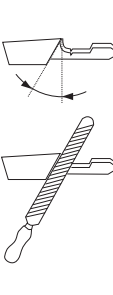
Model	Guide bar				Saw chain	
	Length, cm/ inch	Pitch, inch	Gauge, mm	Max. nose radius	Type	Length, drive links (no.)
418 EL	14 (35)	3/8	1,3	7T	Husqvarna H37	52
420 EL	16 (40)					56

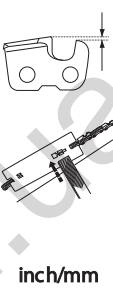
Saw chain filing and file gauges

						
37	5/32 / 4,0	80°	30°	0°	0.025 / 0,65	5796536-01

EC Declaration of Conformity

(Applies to Europe only)

Husqvarna AB, SE-561 82 Huskvarna, Sweden, tel:+46-36-146500, declares under sole responsibility that the corded electric chainsaws 418 EL and 420 EL from 2016's serial numbers and onwards (the year is clearly stated in plain text on the type plate with subsequent serial number), are in conformity with the requirements of the COUNCIL'S DIRECTIVES:

- of May 17, 2006 "relating to machinery" **2006/42/EC**.
- of February 26, 2014 "relating to electromagnetic compatibility" **2014/30/EU**.
- of May 8, 2000 "relating to the noise emissions in the environment" **2000/14/EC**.

The following standards have been applied: **EN 60745-1:2009 + A11:2010**, **EN 60745-2-13:2009 + A1:2010**, **EN 55014-1:2006 + A1:2009 + A2:2011**, **EN 55014-2:2015**, **EN 61000-3-2:2014**, **EN 61000-3-3:2013**

Notified body:

NB2140, DEKRA Testing and Certification GmbH, Enderstraße 92b, 01277 Dresden, Germany, has carried out EC type examination in accordance with the machinery directive's (2006/42/EC) article 12, point 3b. The certificates for EC type examination in accordance with annex IX, have the numbers: 4815039.16001-1

For information relating to noise emissions, see the Technical data chapter.

The supplied chain saw conforms to the example that underwent EC type examination.

Huskvarna September 1, 2016



Lars Roos, Development manager

(Authorized representative for Husqvarna AB and responsible for technical documentation.)

www.husqvarna.com

Original instructions

885539B228

1158372-26



2016-11-28

Autogoods "130"