



PHONES

0 (800) 800 130
(050) 462 0 130
(063) 462 0 130
(067) 462 0 130

130
COM.UA

Internet store of
autogoods



SKYPE

km-130

CAR RECEIVERS — Receivers • Media receivers and stations • Native receivers • CD/DVD changers • FM-modulators/USB adapters • Flash memory • Facia plates and adapters • Antennas • Accessories |
CAR AUDIO — Car audio speakers • Amplifiers • Subwoofers • Processors • Crossovers • Headphones • Accessories | TRIP COMPUTERS — Universal computers • Model computers • Accessories |
GPS NAVIGATORS — Portable GPS • Built-in GPS • GPS modules • GPS trackers • Antennas for GPS navigators • Accessories | VIDEO — DVR • TV sets and monitors • Car TV tuners • Cameras • Videomodules
• Transcoders • Car TV antennas • Accessories | SECURITY SYSTEMS — Car alarms • Bike alarms • Mechanical blockers • Immobilizers • Sensors • Accessories | OPTIC AND LIGHT — Xenon • Bixenon • Lamps
• LED • Stroboscopes • Optic and Headlights • Washers • Light, rain sensors • Accessories | PARKTRONICS AND MIRRORS — Rear parktronic • Front parktronic • Combined parktronic • Rear-view mirrors
• Accessories | HEATING AND COOLING — Seat heaters • Mirrors heaters • Screen-wipers heaters • Engine heaters • Auto-refrigerators • Air conditioning units • Accessories | TUNING — Vibro-isolation
• Noise-isolation • Tint films • Accessories | ACCESSORIES — Radar-detectors • Handsfree, Bluetooth • Windowlifters • Compressors • Beeps, loudspeakers • Measuring instruments • Cleaners • Car seats
• Miscellaneous | MOUNTING — Installation kits • Upholstery • Grilles • Tubes • Cable and wire • Tools • Miscellaneous | POWER — Batteries • Converters • Start-charging equipment • Capacitors
• Accessories | MARINE AUDIO AND ELECTRONICS — Marine receivers • Marine audio speakers • Marine subwoofers • Marine amplifiers • Accessories | CAR CARE PRODUCTS — Additives • Washer fluid •
Care accessories • Car polish • Flavors • Adhesives and sealants | LIQUID AND OIL — Motor oil • Transmission oil • Brake fluid • Antifreeze • Technical lubricant



In store "130" you can find and buy almost all necessary goods for your auto in Kyiv and other cities, delivery by ground and postal services. Our experienced consultants will provide you with exhaustive information and help you to chose the very particular thing. We are waiting for you at the address

<https://130.com.ua>

GROUND ZERO®

GERMAN ENGINEERING

COMPETITION SERIES

AMPLIFIER

OWNER'S MANUAL

GZCA 3.0K-SPL

Features

- 1 Ohm stable mono fullrange amplifier
- High efficient class D technology
- Status LED monitoring
- Illuminated GZ logo
- Up to 12 dB adjustable bass boost (@ 35 to 55 Hz)
- Adjustable high-pass filter
- Adjustable low-pass filter
- Adjustable input sensitivity
- Thermal / short circuit / overload protection

Recommended wiring

	GZCA 3.0K-SPL
Speaker wires	min 2.5 mm ² / 13 AWG
Power supply wires	min 35.0 mm ² / 2 AWG
Remote wire	min 0.75 mm ² / 20 AWG

Mounting instructions

- As a precaution, it is recommended to disconnect the vehicles battery before mounting (also note the vehicles manual)
- The power supply wire (+12 V) has to be protected within max. 20 cm / 8" by a main fuse holder with matching fuse value (Main fuse value has to be equal to the sum of the recommended fuses of all connected devices to the power wire)
- If necessary, replace a defective fuse with the identical value only
- Never drill a hole to the vehicles gas tank or brake lines, to wirings or any other important vehicle part!
- Never pass wires over sharp edges or vehicle parts
- Keep the wiring away from the antenna and electronic devices contributing to radio reception
- Lay the power supply wiring always separated from speaker wiring
- The amplifier contains a temperature protection circuit that turns the device off in case of overheating. After a cooling time, it will turn on again automatically. To avoid heat build-up, sufficient air supply for cooling must be provided. Never cover the surface of the heatsink entirely.
- The amplifier should not be mounted on a strongly vibrating part or surface (e.g. subwoofer enclosure)
- Some amplifiers offer a high-level input option, however if a pre-amplified output (RCA) is available (at the head unit), it is strongly recommended to make use of them.

WARNING !

Powerful car audio systems are able to create extremely high SPL similar to real live concert levels. Permanent exposure to excessively high sound levels may cause damage to or loss of the hearing.

Furthermore, operation of a motor vehicle while listening to audio equipment at high volume levels may impair your ability to concentrate on road traffic and external sounds such as horns, warning signals or emergency vehicles. In the interest of general and own safety, it is recommended to listen to music at appropriately low volume levels while driving.

Controls & Features – GZCA 3.0K-SPL

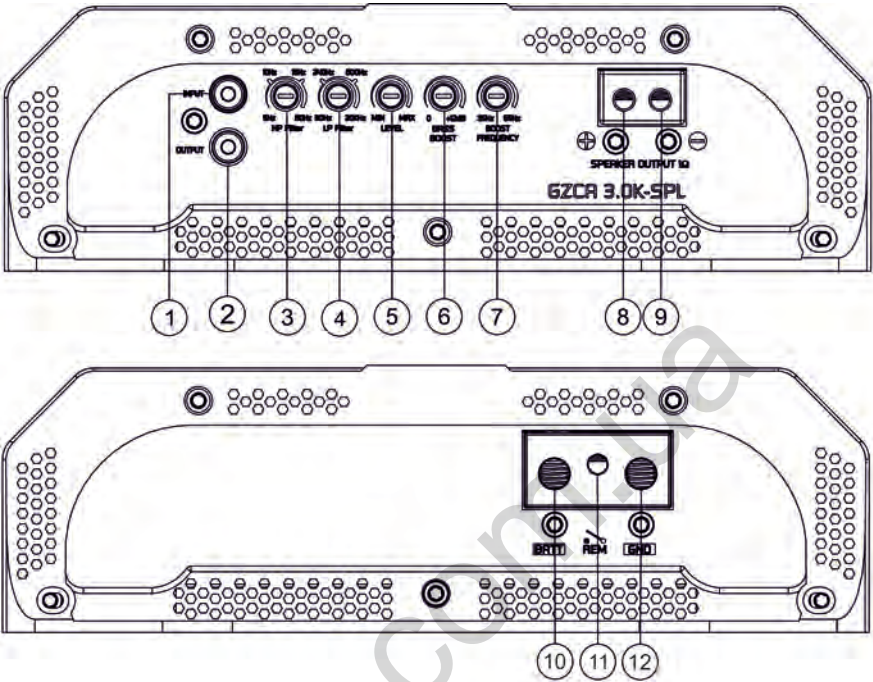

Controls & Features – GZCA 3.0K-SPL

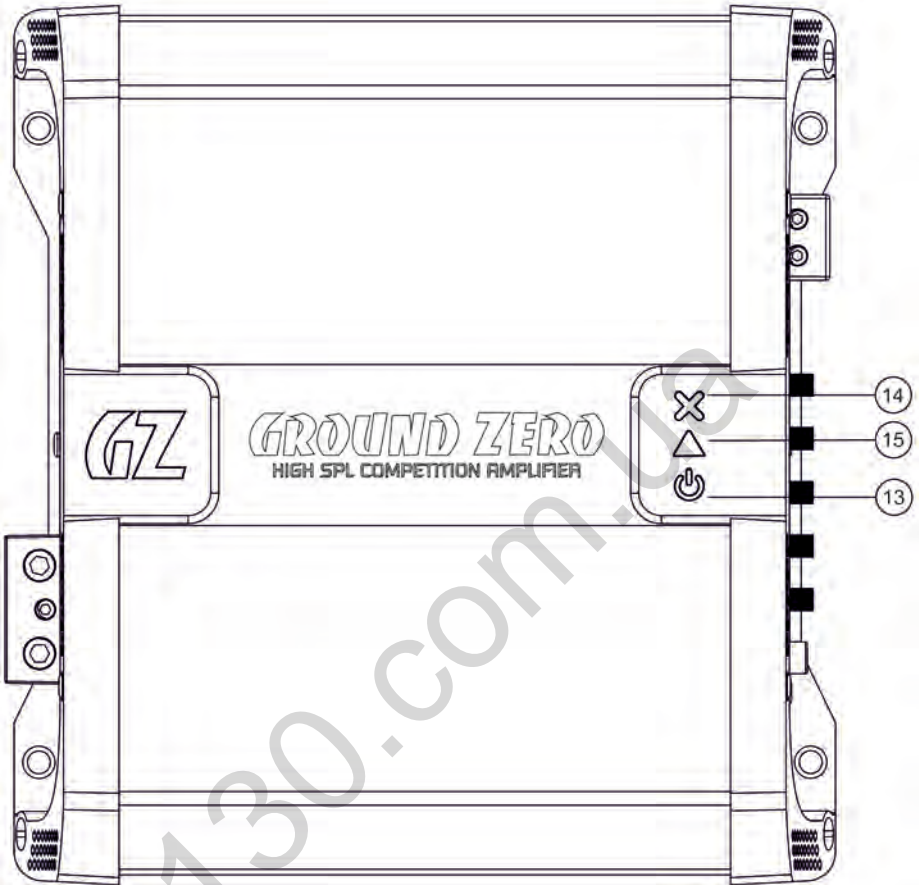

1	INPUT socket	to connect RCA wire* from the audio source / head unit
2	OUTPUT socket	to connect another amplifier /provides the original audio signal
3	FILTER HP control	to adjust the required high pass crossover point from 5 Hz to 80 Hz
4	FILTER LP control	to adjust the required low pass crossover point from 80 Hz to 20 KHz
5	LEVEL control	to adjust the input sensitivity
6	BASS BOOST control	to adjust the bass boost level from 0 dB to +12 dB
7	BOOST FREQ. control	to adjust the bass boost frequency from 35 Hz to 55 Hz
8	OUTPUT terminal	(+) positive speaker wire connection
9		(-) negative speaker wire connection
10	POWER supply terminal	+BAT -> to the battery connection / +12 V
11		REM -> to the remote output of the head unit
12		GND -> to the ground connection
13	STATUS signs	⏻ POWER indication sign
14		✘ PROTECTION indication sign
15		▲ CLIPPING indication sign

* To avoid any kind of malfunction, it is strongly recommended to use high quality RCA wires!

Input and Output wiring – GZCA 3.0K-SPL

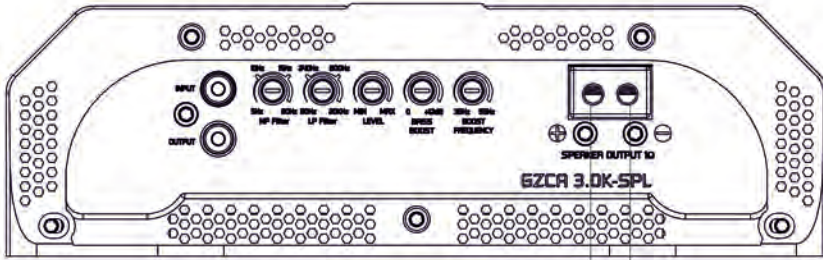

Speaker Load 1~4 Ohm

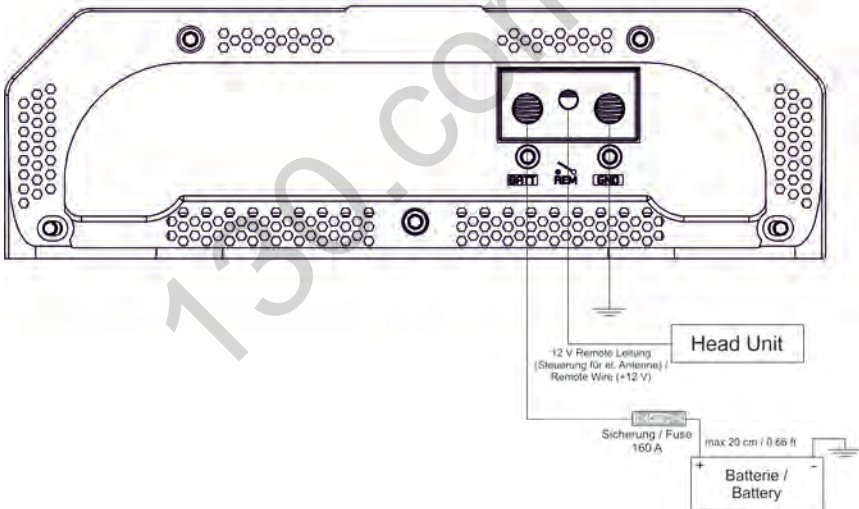

Signal input wiring – GZCA 3.0K-SPL

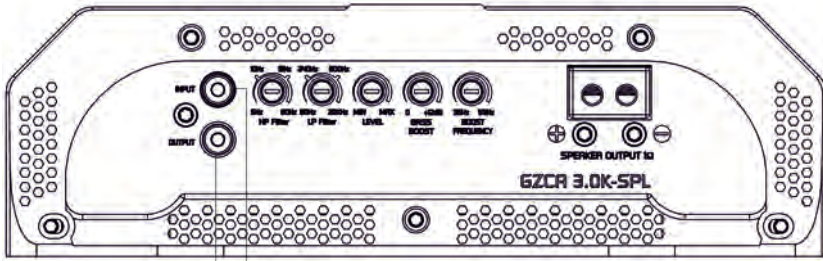

Zum Anschluss weiterer Verstärker /
To next amplifier

Cinch (RCA)
Ausgang / Output











130.com.ua

Specifications

Model	GZCA 3.0K-SPL
Amplifier type	Mono fullrange class D
RMS Power @ 2 Ω measured @ 14.4 V	1800 W (0.1% THD+N)
RMS Power @ 1 Ω measured @ 14.4 V	3400 W (0.1% THD+N)
RMS Power @ 1 Ω measured @ 12.6 V	3000 W (0.1% THD+N)
S/N ratio	84 dB (LPF 15 KHz / nominal power)
THD+N	0.1 % (@ nominal power / 100 Hz / LPF 15 KHz)
Damping factor	>1000 (@100 Hz / nominal power)
Low pass filter	80 Hz ~ 20 KHz
High pass filter	5 Hz ~ 80 Hz
Band pass filter	5 Hz ~ 20 KHz
Bass boost	0 ~ +12 dB (35 Hz ~ 55 Hz)
Frequency response	10 Hz ~ 20 KHz (± 1 dB)
Input sensitivity	500 mV ~ 8 V
Operation voltage	9 V ~ 16 V
Fuse	160 A (must be installed separately!)
Dimensions w x h x l (mm)	225 x 68 x 214
Dimensions w x h x l (inch)	8.85 x 2.67 x 8.43
Weight	2.6 kg / 5.7 lbs
Recommended battery current	min 160 A / ideally 320 A

Trouble shooting guide

Symptoms	Check / Cause	Action
No audible sound	Does the  sign turn to yellow? No? Probably there is no power supply	Check the power line fuse(s) Check remote wire connection to the head unit Check +12 Volt power supply wire connection Check ground wire connection
	Does the  sign blink 10 times? Yes? The battery voltage is too high or too low	The operation voltage must be 9 to 16 V
	Does the  sign blink 10 times? Yes? Load at the speaker terminal is below 1 Ohm	Speaker wires may be shorted (short circuit) Check the wiring and the speakers
	Probably no input signal	Check the RCA wiring to the head unit
	Does the  sign light up red? Yes? Amplifier turned off due to high temperature	Turn off the amplifier until it cools down
	Does the  sign blink permanently red? Yes? The amplifier is probably damaged	Device has to be sent to the service department
Device does not turn on	Does the  sign turn to yellow? No? Probably there is no power supply	Check the power line fuse(s) Check remote wire connection to the head unit Check +12 Volt power supply wire connection Check ground wire connection
	Does the  sign blink permanently red? Yes? The amplifier is probably damaged	Device has to be sent to the service department
Distorted audio signal	Does the  sign turn red? Yes? The output signal is distorted	Decrease the amplifier gain (Level) or Decrease the volume level of the head unit
Amplifier is working, but...	Does the  sign blink frequently red? Yes? The battery voltage is below 9.5 V	Check and load the battery

Terms of warranty

The limited warranty for this product is covered by Ground Zero's local distribution partners and their terms and conditions. For further information contact your local retailer or distributor.

Ground Zero GmbH

Erlenweg 25, 85658 Eggenheim, Germany

Tel. +49 (0)8095/873 830 Fax -8310

www.ground-zero-audio.com

