



PHONES

0 (800) 800 130
(050) 462 0 130
(063) 462 0 130
(067) 462 0 130

130
COM.UA

Internet store of
autogoods



SKYPE

km-130

CAR RECEIVERS — Receivers • Media receivers and stations • Native receivers • CD/DVD changers • FM-modulators/USB adapters • Flash memory • Facia plates and adapters • Antennas • Accessories |
 CAR AUDIO — Car audio speakers • Amplifiers • Subwoofers • Processors • Crossovers • Headphones • Accessories | TRIP COMPUTERS — Universal computers • Model computers • Accessories |
 GPS NAVIGATORS — Portable GPS • Built-in GPS • GPS modules • GPS trackers • Antennas for GPS navigators • Accessories | VIDEO — DVR • TV sets and monitors • Car TV tuners • Cameras • Videomodules
 • Transcoders • Car TV antennas • Accessories | SECURITY SYSTEMS — Car alarms • Bike alarms • Mechanical blockers • Immobilizers • Sensors • Accessories | OPTIC AND LIGHT — Xenon • Bixenon • Lamps
 • LED • Stroboscopes • Optic and Headlights • Washers • Light, rain sensors • Accessories | PARKTRONICS AND MIRRORS — Rear parktronic • Front parktronic • Combined parktronic • Rear-view mirrors
 • Accessories | HEATING AND COOLING — Seat heaters • Mirrors heaters • Screen-wipers heaters • Engine heaters • Auto-refrigerators • Air conditioning units • Accessories | TUNING — Vibro-isolation
 • Noise-isolation • Tint films • Accessories | ACCESSORIES — Radar-detectors • Handsfree, Bluetooth • Windowlifters • Compressors • Beeps, loudspeakers • Measuring instruments • Cleaners • Car seats
 • Miscellaneous | MOUNTING — Installation kits • Upholstery • Grilles • Tubes • Cable and wire • Tools • Miscellaneous | POWER — Batteries • Converters • Start-charging equipment • Capacitors
 • Accessories | MARINE AUDIO AND ELECTRONICS — Marine receivers • Marine audio speakers • Marine subwoofers • Marine amplifiers • Accessories | CAR CARE PRODUCTS — Additives • Washer fluid •
 Care accessories • Car polish • Flavors • Adhesives and sealants | LIQUID AND OIL — Motor oil • Transmission oil • Brake fluid • Antifreeze • Technical lubricant



In store "130" you can find and buy almost all necessary goods for your auto in Kyiv and other cities, delivery by ground and postal services. Our experienced consultants will provide you with exhaustive information and help you to chose the very particular thing. We are waiting for you at the address

<https://130.com.ua>

G.I.KRAFT

Owner's Manual

CE

GI35114

130.com.ua

The equipment is approved by following car manufacturers



Contents

| | |
|--|-----|
| 1、 Introduction | 1 |
| 2、 Specifications | 2 |
| 3、 Installation | 3 |
| 4、 Precautions | 4 |
| 5、 Controls | 5 |
| 6、 Operation | 6-7 |
| 7、 Repair and Maintenance | |
| 7-1、 Exploded View | 8 |
| 7-2、 Troubleshooting | 9 |
| 8、 Electrical Diagram | 10 |
| 9、 Accessories and Spareparts List | 11 |
| 10、 Packing List | |

130.com.ua

Introduction

Introduction

These models battery charger/booster are intended for charging and starting batteries, GI35114 with jump-start function, that are usually used in cars, trucks, motorcycles, boats, etc.

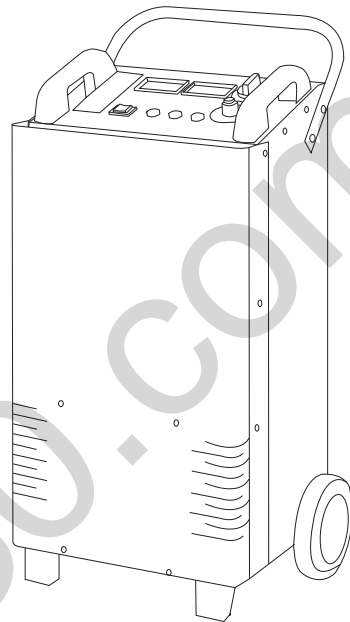

Specifications

| Parameters | Model |
|--------------------------------------|---------------------------|
| | GI35114 |
| Input voltage (v) | 380 |
| Power(KVA) | 2.5/20 |
| Charge voltage (V) | 12/24 |
| Effective charge current (6gears) | 20. 25. 35. 45. 55. 72 |
| Chrging direction (N degree) | 10 |
| Instant current (A) | 1800 |
| Reference Capacitance | 20/1500 |
| Dimensions (mm) | 410*350*795 |
| Weight (kg) | 60 |
| Input cord length(mm) | 3000 |
| Work cable length (mm) | 3000+3000 |

Installation

- 1、 Open package and find out Owner' s Manual.
- 2、 Check the supplied of accessories according to packing list that attached with Owner' s Manual.
- 3、 Properly install this equipment as following diagram. Inspect the unit for any damage. If so, contact your local distributor or service agency.

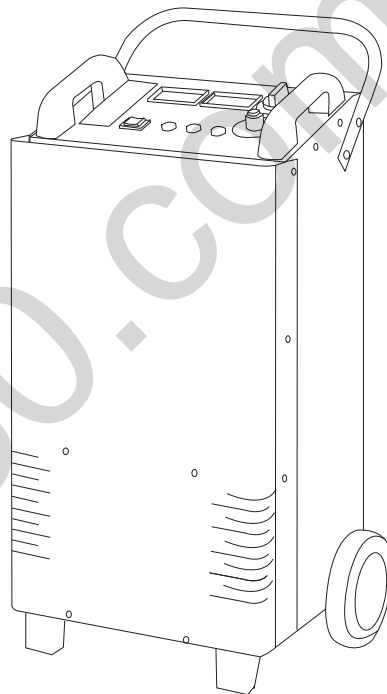

Precautions

- 1、 Select a correct location to place the unit
- 2、 Do not move or operate unit where it could tip
- 3、 Use cart or unit handle to move unit
- 4、 Charging produces explosive gases, Never smoke or allow a spark or flame in vicinity of battery or engine.
- 5、 Operate charger indoor with good ventilation .Do not operate charger to rain or snow or use when wet.
- 6、 Disconnect input power before using charging clips.
- 7、 Electricity arc and spark exist in some electrical component parts of charger such as power switch and relay during normal charging batteries. Keep charger away from inflammables and explosives
- 8、 Do not stop charging suddenly before battery fully charged. Also, never allow clips touch each other.
- 9、 Do not operate charger with damaged cord or plug—replace the cord or plug immediately
- 10、 Never charge a frozen battery.
- 11、 Use only qualified fuse.
- 12、 Clean the battery which will be charged before charging. And check the initial voltage of the battery.
- 13、 Never set Mode switch to “0” position for charging batteries.
- 14、 Do not charge damaged battery , otherwise it will damage the build-in protection
- 15、 Do not switch charging current while battery is being charged.

Controls

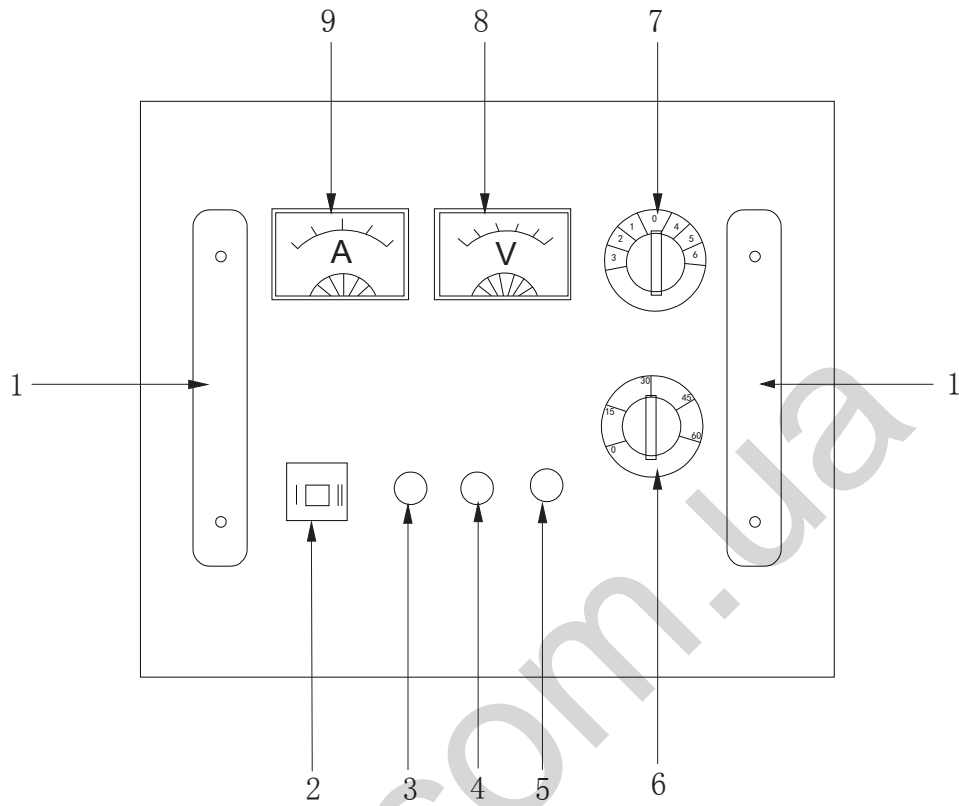

- 1、 Handle
- 2、 12V/24V Selection
- 3、 12V indicator
- 4、 24V indicator
- 5、 Power indicator
- 6、 Timer
- 7、 Current
- 8、 Voltmeter
- 9、 Ammeter

Operation

Charing Connections:

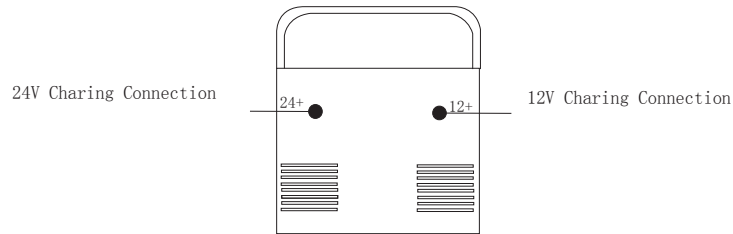

Charging :

- 1) Select 12V or 24V.
- 2) Connect work cables to battery terminals.
The work cable from front of machine is a 12V and 24V cathode cable, connect this cable to the negative terminal of battery. And then, connect another work cable from 12V or 24V Positive terminal of charger to the positive terminal of battery.
- 3) Select charging time and current. The position 1,2,3 of current adjustment knob are slow charge , and 4,5,6 are fast charge. usually, time for fast charge is 60 mins.
- 4) Connect input power, charging time can be set within 60 mins by timer , The charger stops automatically when it reaches pre-set time.

GI35114 Charing Connections:

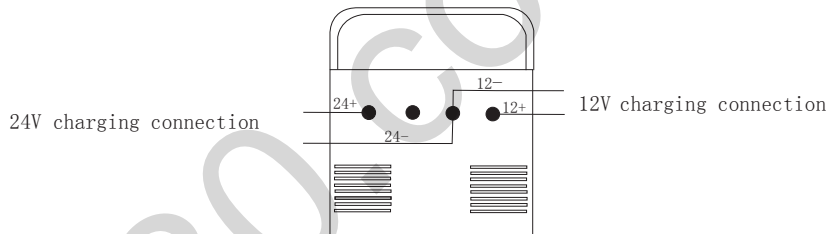

1、Charging

- 1) Select 12V or 24V
- 2) Connect work cables to battery charger terminals as above diagram, and then connect clips from battery charger to the terminals of battery
- 3) Select charging time and current. The position 1,2,3 of current adjustment knob are slow charge , and 4,5,6 are fast charge. usually, time for fast charge is 60 mins.
- 4) Connect input power, charging time can be set within 60 mins by timer , The charger stops automatically when it reaches pre-set time.
- 5) The charger can be charge more than one battery at the same time , but the charging time will be extended

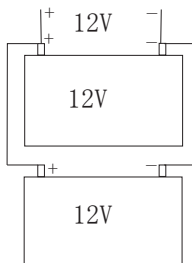

(1)

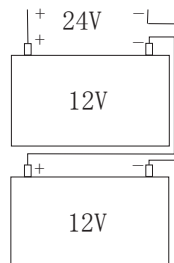

(2)

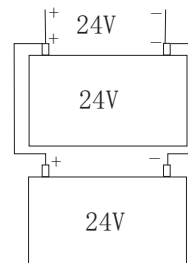

(3)

GI35114 jump-start connection :

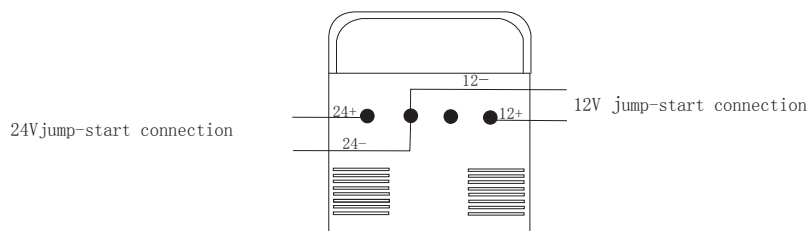

2、 Jump-starting

- 1)、 Select 12V or 24V
- 2)、 Connect work cables to battery charger terminals as above diagram, and then connect clips from battery charger to the terminals of battery
- 3)、 Connect input power.
- 4)、 For high power engines, fast charge the battery for 15mins before jump-starting to get the best result .For diesel engines,pre-heat spark plug before jump starting. For cables connections,connect negative post(-)first, and then positive post(+).
- 5)、 Connect work cables to battery charger terminals while current adjustment knob in " 0 " position, and then turn current adjustment knob to max. position to jump-start the engine. If car engine cannot start after 3-4 times jump-start operations. Please speedy charge the battery for 15 mins before jump-start again.

Note:

- 1、 The positive clip from battery charger must connect to positive post (+) of battery, and connect negative clip to negative post(-)
- 2 、 Do not use the connections of charging to jump-start engine, otherwise it will damage ammeter and fuse
- 3 、 If charger can not jump start engines check input power cord to meet manufacturer' s requirements. or the connections of work cables.

Repair and Maintenance

1、 Exploded view

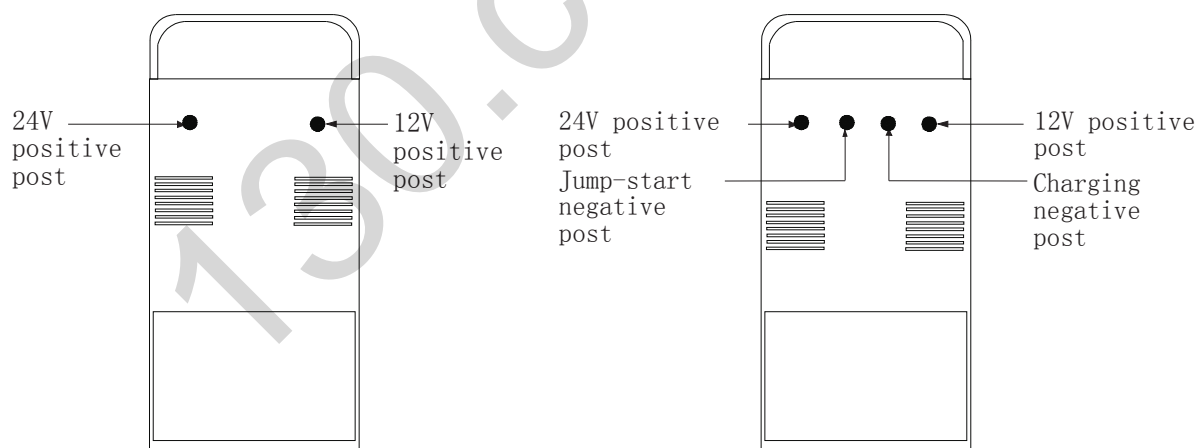
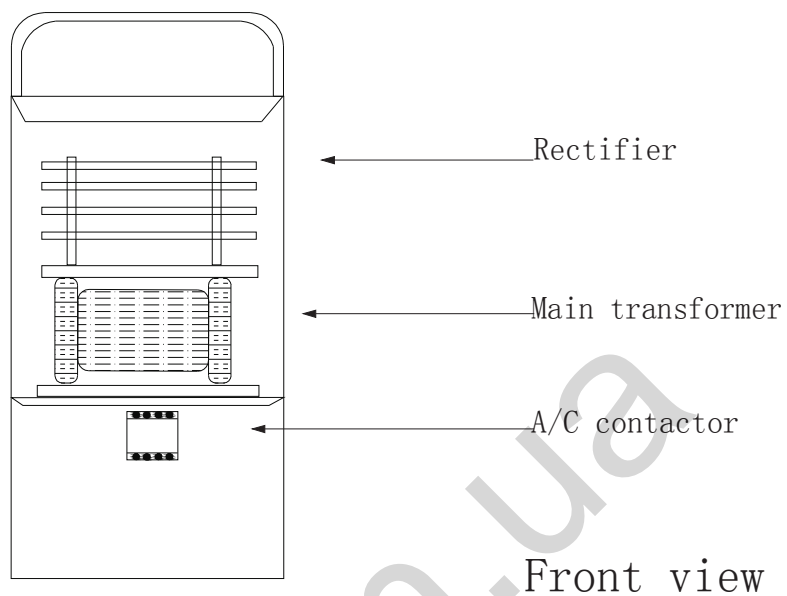

GI35114

Rear view

2、 Troubleshooting





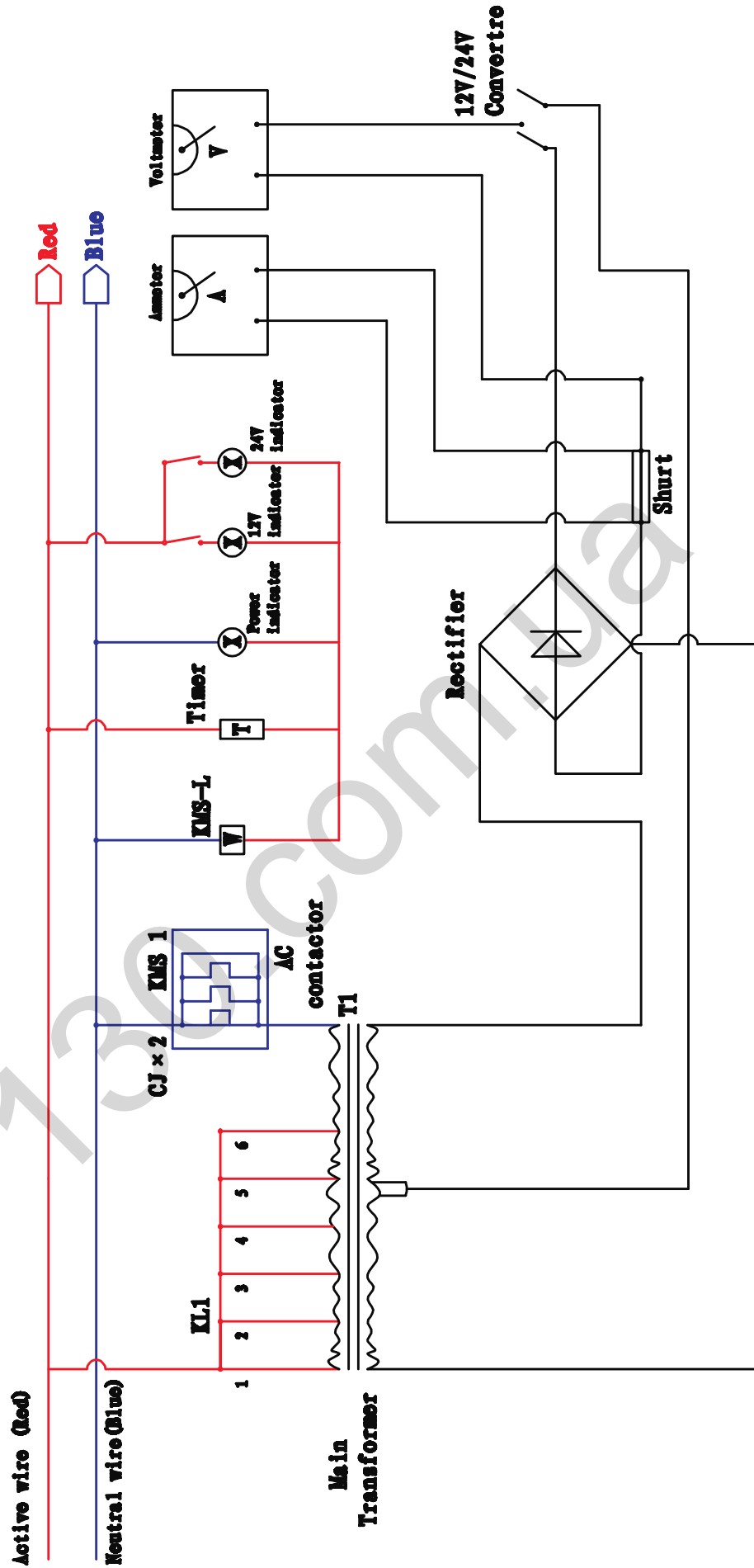





| Trouble | Probable cause | Remedy |
|---|---|---|
| No input power | (1)incorrect input power connection (2)Power switch in " off" position | (1)Check input power connection (2)Turn power switch to "on" position |
| Timer does not work | (1) Charging time has not adjusted (2) Timer damaged | (1) Adjust charging time (2)Replace timer |
| Not enough electricity power of charged Battery | (1)Improperly connect work cables or clamps (2) Not enough charging current (3) Not enough charging time (4) Ex cess charge rate of battery capacity | (1)Check cables connections and tighten clamps (2)increase charging current (3)increase charging time (4)Check correct charge rate for the battery being charged |
| Charger stops working while operating | (1)Timer reaches preset time (2)Charger over heat | (1)Adjust timer (2)Wait for charger temperature cool down |
| Voltmeter does not work | (1)Switches in "off" position (2)12V/24Vswitch in neutral | (1)Turn on power, adjust timer and current (2)Select 12Vor24V |
| Ammeter does not work | (1)No out put current | (1)Ammeter works while under loading only |
| Cannot charging battery | (1) Incorrect cables connections (2) Switches in "off"position (3) Battery had been damaged | (1) Check cables connections (2)Adjust switches to correct position (3)Check battery |

Circuit Diagram



Accessories and spareparts list

Accessories and spareparts list

| | |
|---|---|
|  Front stand |  Handle |
|  Amperage switch |  Rectifier |
|  Power switch |  Timer |
|  Voltmeter |  Wheel |
|  Ground clamp |  Ammeter |
|  Output cord | |

Remarks:

- 1) Optional orders for above accessories and spareparts are available.
- 2) Model and parts number required when ordering parts from your local distributor or service agency.