



PHONES

0 (800) 800 130  
(050) 462 0 130  
(063) 462 0 130  
(067) 462 0 130

130  
COM.UA

Internet store of  
autogoods



SKYPE

km-130

CAR RECEIVERS — Receivers • Media receivers and stations • Native receivers • CD/DVD changers • FM-modulators/USB adapters • Flash memory • Facia plates and adapters • Antennas • Accessories |  
 CAR AUDIO — Car audio speakers • Amplifiers • Subwoofers • Processors • Crossovers • Headphones • Accessories | TRIP COMPUTERS — Universal computers • Model computers • Accessories |  
 GPS NAVIGATORS — Portable GPS • Built-in GPS • GPS modules • GPS trackers • Antennas for GPS navigators • Accessories | VIDEO — DVR • TV sets and monitors • Car TV tuners • Cameras • Videomodules  
 • Transcoders • Car TV antennas • Accessories | SECURITY SYSTEMS — Car alarms • Bike alarms • Mechanical blockers • Immobilizers • Sensors • Accessories | OPTIC AND LIGHT — Xenon • Bixenon • Lamps  
 • LED • Stroboscopes • Optic and Headlights • Washers • Light, rain sensors • Accessories | PARKTRONICS AND MIRRORS — Rear parktronic • Front parktronic • Combined parktronic • Rear-view mirrors  
 • Accessories | HEATING AND COOLING — Seat heaters • Mirrors heaters • Screen-wipers heaters • Engine heaters • Auto-refrigerators • Air conditioning units • Accessories | TUNING — Vibro-isolation  
 • Noise-isolation • Tint films • Accessories | ACCESSORIES — Radar-detectors • Handsfree, Bluetooth • Windowlifters • Compressors • Beeps, loudspeakers • Measuring instruments • Cleaners • Car seats  
 • Miscellaneous | MOUNTING — Installation kits • Upholstery • Grilles • Tubes • Cable and wire • Tools • Miscellaneous | POWER — Batteries • Converters • Start-charging equipment • Capacitors  
 • Accessories | MARINE AUDIO AND ELECTRONICS — Marine receivers • Marine audio speakers • Marine subwoofers • Marine amplifiers • Accessories | CAR CARE PRODUCTS — Additives • Washer fluid •  
 Care accessories • Car polish • Flavors • Adhesives and sealants | LIQUID AND OIL — Motor oil • Transmission oil • Brake fluid • Antifreeze • Technical lubricant



In store "130" you can find and buy almost all necessary goods for your auto in Kyiv and other cities, delivery by ground and postal services. Our experienced consultants will provide you with exhaustive information and help you to choose the very particular thing. We are waiting for you at the address

<https://130.com.ua>

# DALI KATCH ONE

MANUAL



DALI

IN ADMIRATION OF MUSIC

Autogoods "130"

## CONTENTS

<b>1.0 Unpacking</b> .....	<b>3</b>	<b>4.0 Volume</b> .....	<b>9</b>	7.4 Optical In .....	13
<b>2.0 Buttons, indication LED's and Connections</b> .....	<b>5</b>	4.1 Volume Down .....	9	7.5 Optical In (TV) .....	13
2.1 Button and LED Overview .....	4	4.2 Volume Up .....	9	7.6 HDMI In .....	14
2.2 Input/output overview .....	5	4.3 Volume Indications .....	9	<b>8.0 Positioning</b> .....	<b>15</b>
2.3 Remote control .....	6	<b>5.0 Bluetooth</b> .....	<b>10</b>	<b>9.0 Factory Reset &amp; Firmware Upgrade</b> .....	<b>16</b>
2.4 Bluetooth button functions .....	6	5.1 Pairing .....	10	9.1 Factory Reset .....	16
<b>3.0 Power and Auto Source Select</b> .....	<b>7</b>	5.2 Bluetooth Release .....	11	9.2 Firmware upgrade .....	16
3.1 Power ON .....	7	5.3 Bluetooth Naming .....	11	9.3 Firmware - Readout Current Version .....	17
3.2 Power OFF .....	7	<b>6.0 Sound Mode</b> .....	<b>12</b>	<b>10.0 Cleaning</b> .....	<b>18</b>
3.3 Auto Power OFF .....	7	<b>7.0 Connections</b> .....	<b>13</b>	<b>11.0 Disposal</b> .....	<b>19</b>
3.4 Auto Source Select .....	8	7.1 USB Power Out / Service .....	13		
		7.2 Sub Out .....	13		
		7.3 AUX In .....	13		



## 1.0 UNPACKING

Be careful not to damage the contents when unpacking the parts. Check that all parts are included in the cardboard box. Keep the packaging materials in case your speaker needs to be relocated or serviced.

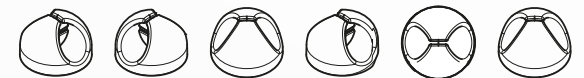
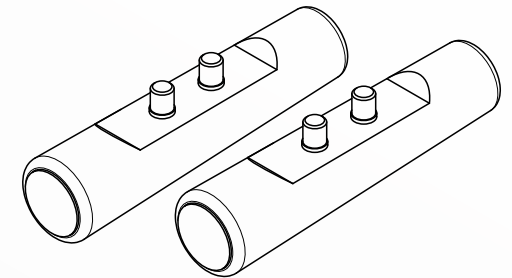
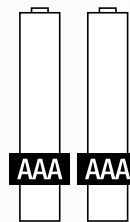
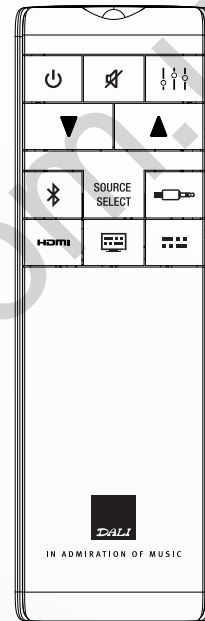
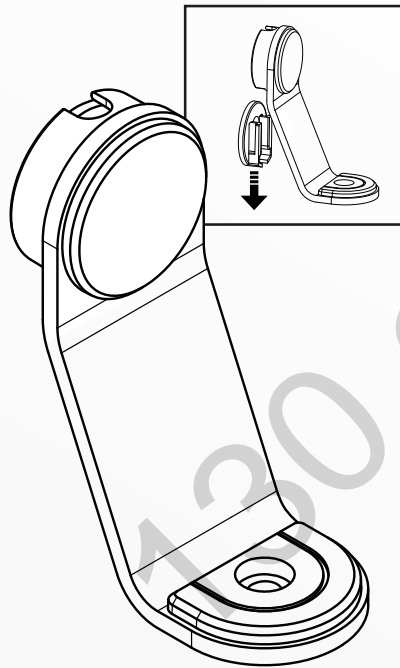
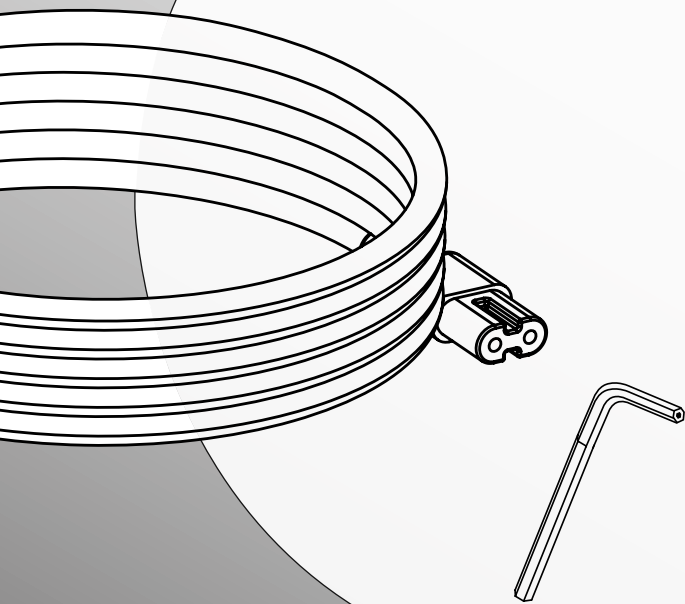

## 2.0 BUTTONS, INDICATION LED'S AND CONNECTIONS

### 2.1 BUTTON AND LED OVERVIEW

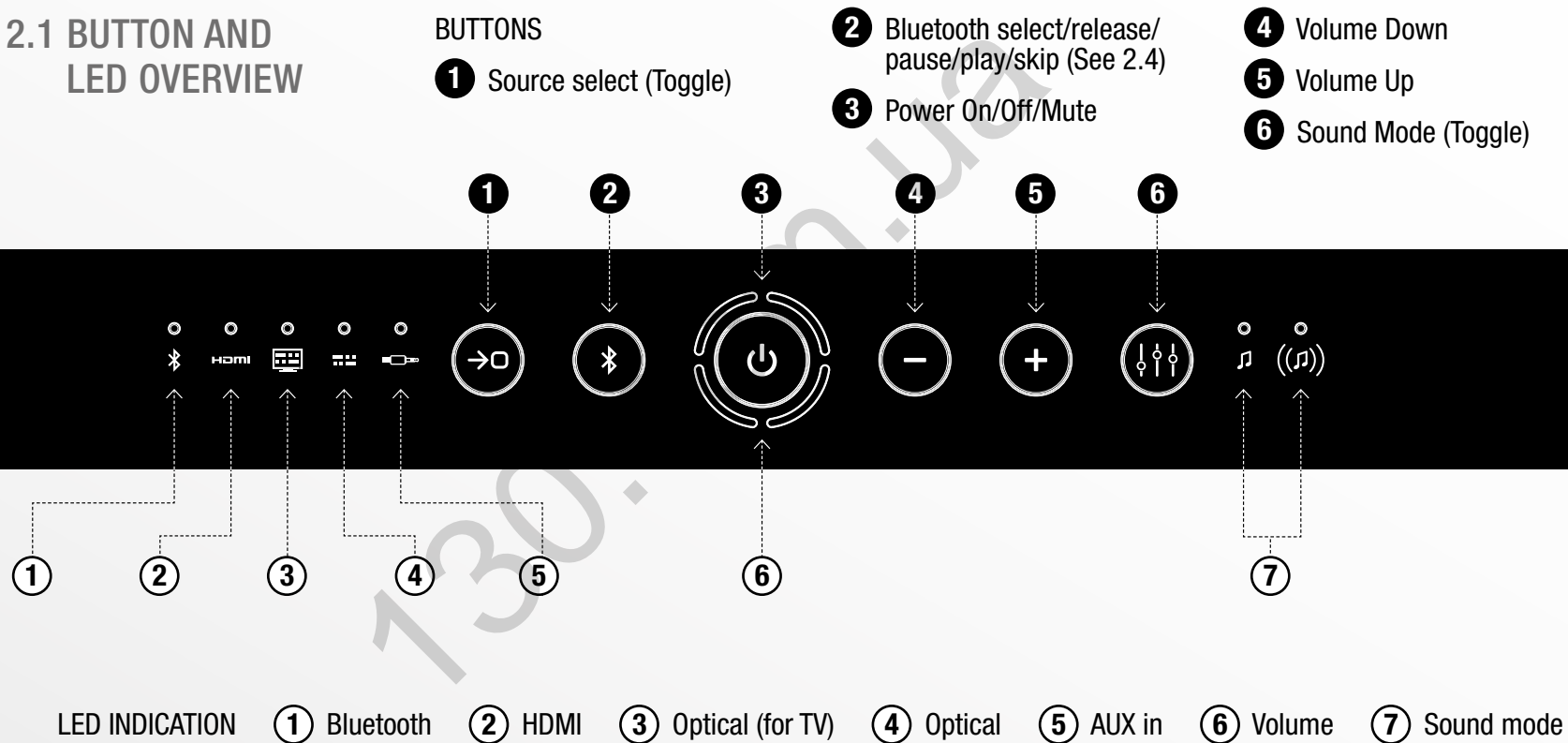

## 2.0 BUTTONS, INDICATION LED'S AND CONNECTIONS

### 2.2 INPUT/OUTPUT OVERVIEW

See 7.0 for a detailed description of all the connectors.



Mains power

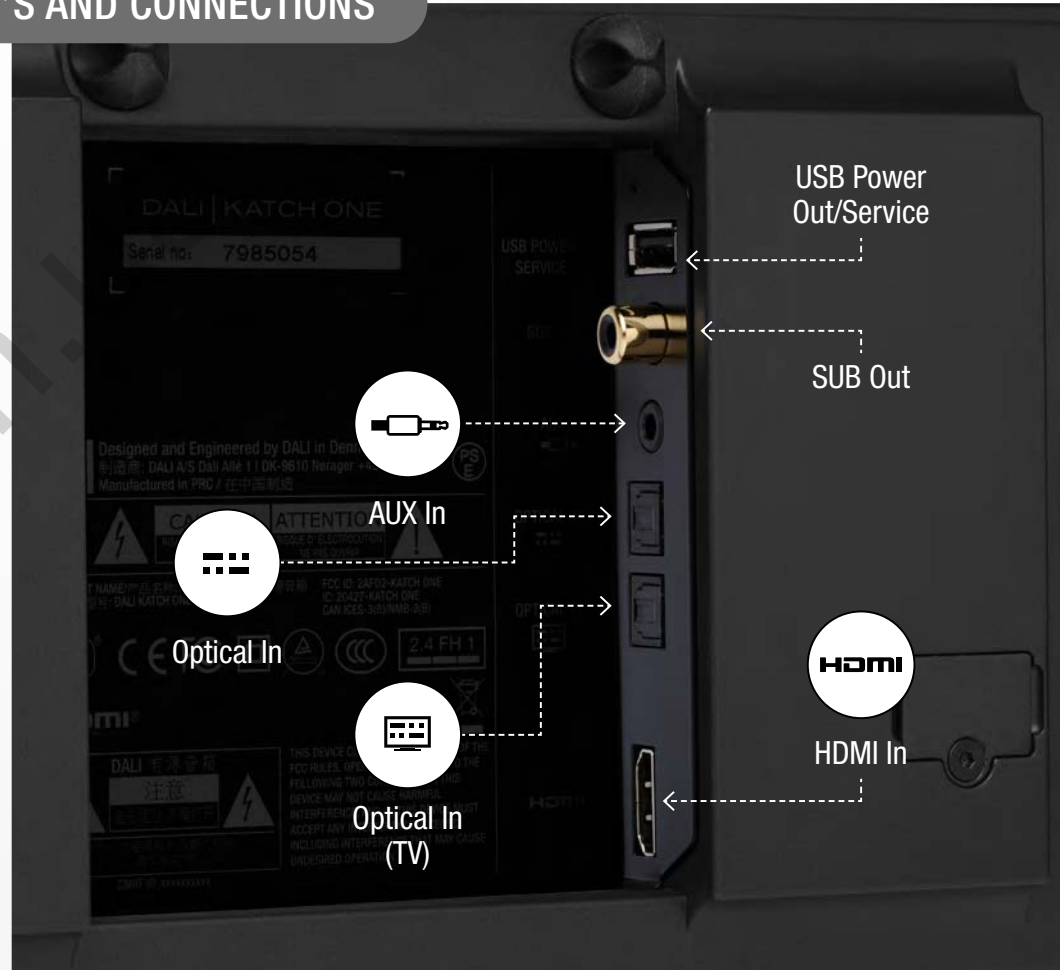

USB Power Out/Service

SUB Out

AUX In

Optical In

Optical In (TV)

HDMI In



## 2.0 BUTTONS, INDICATION LED'S AND CONNECTIONS

### 2.3 REMOTE CONTROL

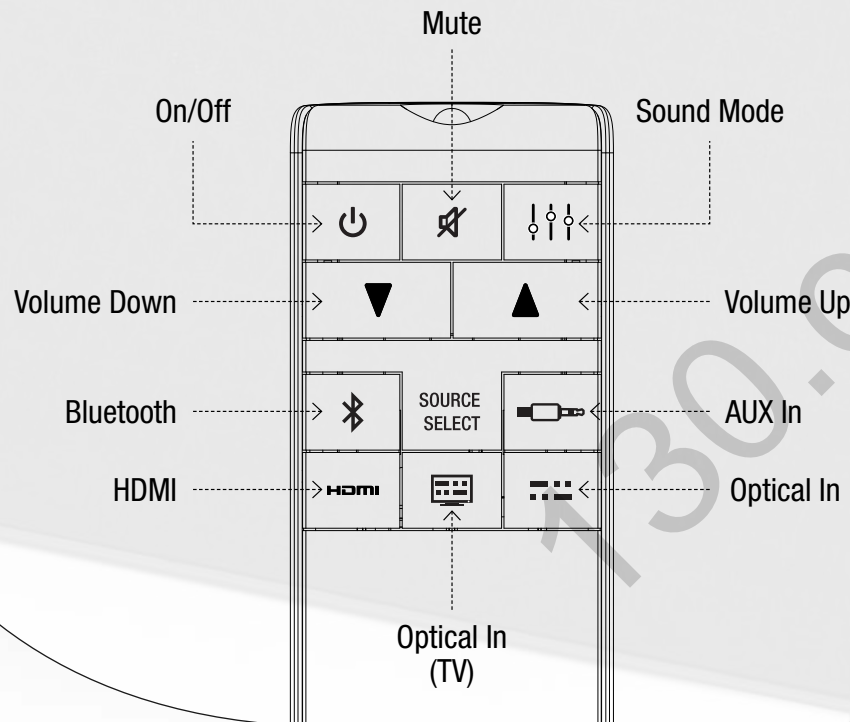

### 2.4 BLUETOOTH BUTTON FUNCTIONS

The Bluetooth button (Button **2**) and the remote control Bluetooth button can be used to select/release/pause/play/skip to next track.

Select Bluetooth	Short press
Pause/Play music	Short press
Skip track forward	Two quick short presses
Skip track backwards	Three quick short presses
Release Bluetooth connection	Press and hold till the Bluetooth LED (LED <b>1</b> ) start blinking



## 3.0 POWER AND AUTO SOURCE SELECT

### 3.1 POWER ON

To turn ON the DALI KATCH ONE;

1. Press the Power ON/OFF button (Button **3**)
2. The indicator light (LED **6**) is illuminated indicating the current volume and the input /Sound Mode indicator LED's shows the last used settings
3. The KATCH ONE is ready for use

If your DALI KATCH ONE does not turn on, check if the mains cable is connected correctly (See 2.2)

### 3.2 POWER OFF

To turn OFF the DALI KATCH ONE;

1. Press and hold Power ON/OFF button (Button **3**)
2. The indicator LED's are turned off

### 3.3 AUTO POWER OFF

The DALI KATCH ONE will automatically turn off if no audio has been playing for 20 minutes. If the KATCH ONE is connected to a TV via HDMI and CEC is enabled (See 7.6) a power off command from the TV will also power off the KATCH ONE.

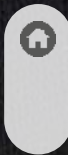



### 3.0 POWER AND AUTO SOURCE SELECT

#### 3.4 AUTO SOURCE SELECT

The DALI KATCH ONE will automatically turn on and start playing if audio is played to any of the inputs, if a TV connected to the HDMI is turned on (See 7.6) or if a Bluetooth connected device starts playback.

If the DALI KATCH ONE is turned on and no audio is playing, starting playback on a different input will cause the KATCH ONE to automatically switch to the active input.

It is possible to disable Auto Power ON/OFF and Auto Source Select. Follow the steps below to deactivate/activate this feature;

1. Press and hold Source Select (Button **1**)
2. While holding down the Source Select (Button **1**) press Volume Down (Button **4**) to disable Auto Power ON/OFF and Auto Source Select
3. While holding down the Source Select (Button **1**) press Volume Up (Button **5**) to enable Auto Power ON/OFF and Auto Source Select (Default setting)



## 4.0 VOLUME

### 4.1 VOLUME DOWN

To turn down the volume on the DALI KATCH ONE;

1. Press the Volume Down button on the KATCH ONE (Button **4**) or on the remote control

To quickly turn down the volume, press and hold the Volume Down button.

### 4.2 VOLUME UP

To turn up the volume on the DALI KATCH ONE;

1. Press the Volume Up button on the KATCH ONE (Button **5**) or on the remote control

To quickly turn up the volume, press and hold the Volume Up button.

### 4.3 VOLUME INDICATIONS

The indicator lights (LED **6**) will indicate the volume setting.

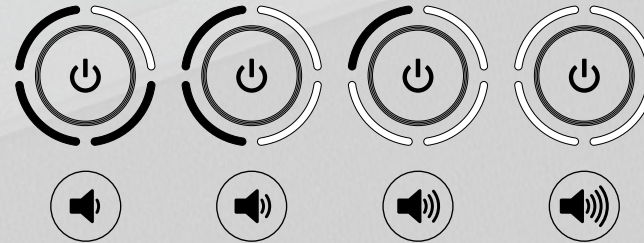

Mute state is indicated by the indicator lights (LED **6**) blinking.



## 5.0 BLUETOOTH

### 5.1 PAIRING

To connect your device to the DALI KATCH ONE;

1. Turn on the DALI KATCH ONE (See 3.1)
2. Select Bluetooth (Button **2**)
3. The DALI KATCH ONE is now ready for Bluetooth pairing
  - a. If the Bluetooth LED (LED **1**) is blinking no device is currently paired
  - b. If the Bluetooth LED (LED **1**) is not blinking a device is connected.  
To disconnect the connected device use the Bluetooth Release function (5.2)
  - c. It is only possible to have one device connected at any time
4. Initiate the Bluetooth pairing process from your device
5. When the pairing is complete, the Bluetooth pairing sound is played

The DALI KATCH ONE will automatically connect to a device when Bluetooth is selected, if a device has been paired to the KATCH ONE earlier, and is within range. The KATCH ONE will not initiate auto playback. Playback has to be started from the connected device or by pressing the Bluetooth button shortly on KATCH ONE or the remote control.

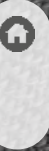

## 5.0 BLUETOOTH

### 5.2 BLUETOOTH RELEASE

If you are unable to pair your device to the DALI KATCH ONE;

1. Press and hold the Bluetooth release button (Button **2**) until the Bluetooth release sound plays and the Bluetooth LED (LED **1**) starts blinking
2. The connected devices are now released and you can re-engage the pairing (See 5.1)

### 5.3 BLUETOOTH NAMING

If you have more than one DALI KATCH ONE, it is possible to change the Bluetooth name of your DALI KATCH ONE.

1. Turn on the DALI KATCH ONE (See 3.1)
2. Press and hold the Power ON/OFF button (Button **3**)
3. Then press either Volume Up (Button **5**) or Volume Down (Button **4**) to circle through the possible names (DALI KATCH ONE, DALI KATCH ONE 1, DALI KATCH ONE 2 and DALI KATCH ONE 3)



DALI KATCH ONE



DALI KATCH ONE 1



DALI KATCH ONE 2



DALI KATCH ONE 3

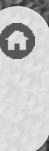

## 6.0 SOUND MODE

The DALI KATCH ONE has two sound modes, Focus and Wide.  
To toggle between the two sound modes press the Sound Mode button (Button 6).  
The Sound Mode LED (LED 7) indicates the selected sound mode.

 Wide (Default)

Expands the sound beyond the KATCH ONE physical dimensions.  
Perfect for movies and concerts experiences.

 Focus

Delivers a more focused stereo signal.  
Perfect for news, documentaries and talk shows.

## 7.0 CONNECTIONS

### 7.1 USB POWER OUT / SERVICE

The USB charge port delivers 5V/1A, which makes it possible to charge most devices directly from the DALI KATCH ONE.

It is also possible to power a Google Chromecast Audio or similar devices, making it possible to integrate the DALI KATCH ONE with your home network.

*Note: It is not possible to play music via the USB port.*

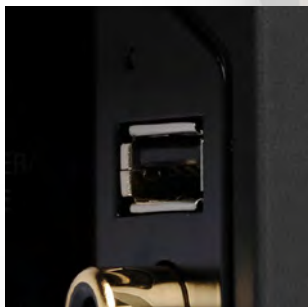

### 7.2 SUB OUT

Add a subwoofer to your DALI KATCH ONE system for even better bass performance.

### 7.3 AUX IN

Connect any analogue output device to the DALI KATCH ONE using a stereo mini-jack cable.

### 7.4 OPTICAL IN

Connect any optical S/PDIF audio device to the DALI KATCH ONE.

### 7.5 OPTICAL IN (TV)

Connect a TV to the DALI KATCH ONE using the optical output.



## 7.0 CONNECTIONS

### 7.6 HDMI IN

Connect a TV to the DALI KATCH ONE using HDMI ARC.

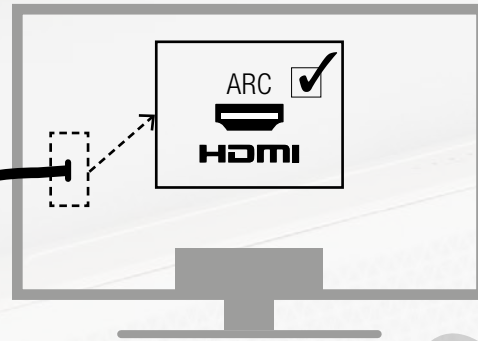

This connection requires that the DALI KATCH ONE is connected to your TV's HDMI ARC input, that CEC is turned on (will be described later), and that you select alternative audio output in the TV's audio menu. Also the audio output must be set to Stereo or PCM. The correct menu and wording will differ between TV brands. Please refer to your TV manual for the correct settings on your TV.

If your TV do not support HDMI ARC, DALI recommend using an Optical connection to the DALI KATCH ONE (See 7.5). In this case it is still possible to simultaneously use the HDMI connection to enable the TV remote control for use with the KATCH ONE using the CEC function (See below).

To enable the use of your TV remote over HDMI to control basic functions (volume, mute power on/off) your TV needs to have HDMI CEC enabled.

HDMI CEC has different names depending on the TV brand:

- Samsung: Anynet+
- LG: SimpLink
- Sony: Bravia Link
- Phillips: EasyLink
- Panasonic: Viera Link
- Hitachi: HDMI-CEC



## 8.0 POSITIONING



The DALI KATCH ONE is designed to deliver the best possible sound experience mounted on the wall, or standing on the included feet right up against the wall. If placed away from the wall the KATCH ONE's bass performance will be lowered.

To get the best possible audio experience place the DALI KATCH ONE so the front of the KATCH ONE is playing directly towards the primary listening position.





## 9.0 FACTORY RESET & FIRMWARE UPGRADE

### 9.1 FACTORY RESET

To reset the DALI KATCH ONE to the factory state;

1. Stop any playback to the DALI KATCH ONE
2. Turn off the DALI KATCH ONE (See 3.2)
3. Press and hold the Sound mode toggle button (Button **6**) and press the Power ON/OFF button (Button **3**) until an audio indication is played
4. Release both buttons
5. All the indicator LED's turn on and the firmware version is shown (See 9.3)
6. Wait for about 10 seconds
7. Turn off the DALI KATCH ONE (See 3.2)
8. The unit is now reset

### 9.2 FIRMWARE UPGRADE

Download the latest firmware from our website and unzip the file to your Windows computer.

Use the DALI Tool included in the firmware download to place the firmware file on a USB memory stick. Insert the USB memory stick into the USB Power Out / Service connector.

1. Unplug your DALI KATCH ONE (See 3.2)
2. Insert the USB stick into the USB Power Out / Service Port
3. Power on your DALI KATCH ONE (See 3.1)
4. Wait for the Power LED next to the USB Power Out / Service Port to start blinking
5. Remove the USB stick for the USB Power Out / Service Port
6. The DALI KATCH ONE is now updated

Look for new firmware here:

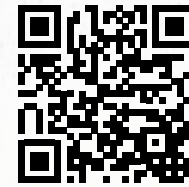

[www.dali-speakers.com/katchone](http://www.dali-speakers.com/katchone)

## 9.0 FACTORY RESET & FIRMWARE UPGRADE

### 9.3 FIRMWARE - READOUT CURRENT VERSION

Initiate factory reset (See 9.1) to read out current firmware version.

The current firmware version is automatically shown by an indicator light sequence. It is interpreted by the sum of the indicator lights using the following format:

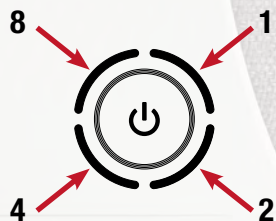

#### FLASH 1:

First digit(s)

#### FLASH 2:

“ ”

#### FLASH 3:

Last digit(s)

#### EXAMPLE: VERSION 1.1

Flash 1:



SUM = 1

Flash 2:



.

Flash 3:



SUM = 1

#### EXAMPLE: VERSION 2.5

Flash 1:



SUM = 2

Flash 2:



.

Flash 3:



SUM = 1+4 = 5



## 10.0 CLEANING

Clean the cabinet with a soft, dry cloth. If the cabinet are dirty, wipe with a soft cloth dipped in all-purpose cleaner and then well wrung out. As this is product contains electronics, be careful not to get it wet, and keep it clear of water.



IN ADMIRATION OF MUSIC  
Autogoods "130"



## 11.0 DISPOSAL

If you want to dispose of this product, do not mix it with general household waste. There is a separate collection system for used electronic products in accordance with legislation that requires proper treatment, recovery and recycling. Private households in the EU member states, Switzerland, Liechtenstein and Norway may return their used electronic products free of charge to designated collection facilities or to a retailer (If you purchase a similar new one). If you reside in countries not mentioned above, please contact your local authorities for the correct method of disposal. By following this process, you will ensure that your disposed product undergoes the necessary treatment, recovery and recycling and thus prevent potential negative effects on the environment and human health.



IN ADMIRATION OF MUSIC  
Autogoods "130"

