



PHONES

(044) 360-7-130  
(050) 336-0-130  
(063) 788-0-130  
(067) 233-0-130  
(068) 282-0-130

# 130 Internet store of autogoods

COM.UA



ICQ  
294-0-130  
597-0-130

SKYPE  
km-130

CAR RECEIVERS — Receivers • Media receivers and stations • Native receivers • CD/DVD changers • FM-modulators/USB adapters • Flash memory • Facia plates and adapters • Antennas • Accessories |  
CAR AUDIO — Car audio speakers • Amplifiers • Subwoofers • Processors • Crossovers • Headphones • Accessories | TRIP COMPUTERS — Universal computers • Model computers • Accessories |  
GPS NAVIGATORS — Portable GPS • Built-in GPS • GPS modules • GPS trackers • Antennas for GPS navigators • Accessories | VIDEO — DVR • TV sets and monitors • Car TV tuners • Cameras • Videomodules  
• Transcoders • Car TV antennas • Accessories | SECURITY SYSTEMS — Car alarms • Bike alarms • Mechanical blockers • Immobilizers • Sensors • Accessories | OPTIC AND LIGHT — Xenon • Bixenon • Lamps  
• LED • Stroboscopes • Optic and Headlights • Washers • Light, rain sensors • Accessories | PARKTRONICS AND MIRRORS — Rear parktronic • Front parktronic • Combined parktronic • Rear-view mirrors  
• Accessories | HEATING AND COOLING — Seat heaters • Mirrors heaters • Screen-wipers heaters • Engine heaters • Auto-refrigerators • Air conditioning units • Accessories | TUNING — Vibro-isolation  
• Noise-isolation • Tint films • Accessories | ACCESSORIES — Radar-detectors • Handsfree, Bluetooth • Windowlifters • Compressors • Beeps, loudspeakers • Measuring instruments • Cleaners • Carsits  
• Miscellaneous | MOUNTING — Installation kits • Upholstery • Grilles • Tubes • Cable and wire • Tools • Miscellaneous | POWER — Batteries • Converters • Start-charging equipment • Capacitors  
• Accessories | MARINE AUDIO AND ELECTRONICS — Marine receivers • Marine audio speakers • Marine subwoofers • Marine amplifiers • Accessories | CAR CARE PRODUCTS — Additives • Washer fluid •  
Care accessories • Car polish • Flavors • Adhesives and sealants | LIQUID AND OIL — Motor oil • Transmission oil • Brake fluid • Antifreeze • Technical lubricant



In store "130" you can find and buy almost all necessary goods for your auto in Kyiv and other cities, delivery by ground and postal services. Our experienced consultants will provide you with exhaustive information and help you to chose the very particular thing. We are waiting for you at the address

<http://130.com.ua>

## Dotech ovation specifications

WOOFERS	Dotech Ovation 4	Dotech Ovation 5	Dotech Ovation 6
Nominal Impedance	4.00 ohm	4.00 ohm	4.00 ohm
Power Handling	100W	120W	140W
Max. Transient Power Handling	300W	300W	300W
Sensitivity (2.83V/1M)	88dB	89dB	90dB
Frequency Response	50-4000Hz	45-4500Hz	40-4000Hz
FS	95Hz	67Hz	65Hz
Voice Coil Diameter	54.00mm (2.10")	54.00mm (2.10")	54.00mm (2.10")
Voice Coil Height	8.00mm (0.31")	12.00mm (0.48")	12.00mm (0.48")
Voice Coil Type/ Former	Aluminum	Aluminum	Aluminum
Voice Coil Wire	Hexatech aluminum	Hexatech aluminum	Hexatech aluminum
DC Resistance	3.00 ohm	3.50 ohm	3.50 ohm
Voice Coil Inductance @1kHz	0.17MH	0.21MH	0.21MH
Magnet System	Double ferrite rear vented	Double ferrite rear vented	Double ferrite rear vented
HE-Magnetic Gap Height	4.00mm (0.16")	4.00mm (0.16")	4.00mm (0.16")
B-Flux Density	0.65T	0.68T	0.68T
BL Product/BXL	2.53	2.95	2.97
Max. Linear Excursion/Xmax	4.00mm (±2.00mm)	8.00mm (±4.00mm)	8.00mm (±4.00mm)
Suspension Compliance CMS	456	744	613
Mechanical Q Factor QES	1.41	1.28	1.35
Total Q Factor Q/T	0.98	0.90	1.09
QMS	3.29	2.99	5.60
Mechanical Resistance RMS	0.39kgS <sup>1</sup>	0.36kgS <sup>1</sup>	0.32kgS <sup>1</sup>
Moving Mass MMS	4.35gr	7.46gr	10.00gr
Equivalent Cas Air Load VAS	2.68L (0.09ft <sup>3</sup> )	8.47L (0.30ft <sup>3</sup> )	13.00L (0.46ft <sup>3</sup> )
Effective Piston Area SD	64cm <sup>2</sup> (9.92in <sup>2</sup> )	90cm <sup>2</sup> (13.95in <sup>2</sup> )	119cm <sup>2</sup> (18.45in <sup>2</sup> )
Cone Material	Composite cellular fiber	Composite cellular fiber	Composite cellular fiber
Unit Diameter	104.00mm (4.00")	135.00mm (5.25")	165.00mm (6.50")
Mounting Depth	50.00mm (2.00")	60.00mm (2.36")	60.00mm (2.36")
Mounting Cutout	95.00mm (3.74")	120.00mm (4.72")	141.00mm (5.55")
Net Weight	0.54kg (1.19lb)	0.55kg (1.21lb)	0.60kg (1.32lb)

### TWEETER MT-12

Nominal Impedance	4.00 ohm
Power Handling	80W
Max. Transient Power Handling	250W
Sensitivity (2.83V/1M)	91dB
Frequency Response	1800-22000Hz
FS	950Hz
Voice Coil Diameter	28.00mm (1.10")
Voice Coil Former	Aluminum
Voice Coil Wire	Copper
DC Resistance	3.40 ohm
Magnet System	Neodymium
Dome Type	Acuflex soft dome
Dome Material	Silk
Unit Diameter	45.00mm (1.80")
Mounting Depth	20.00mm (0.80")
Mounting Cutout	50.00mm (2.00")
Net Weight	0.06kg (0.13lb)

### CROSSOVER MX-20-4,5,6

Nominal Impedance	4.00 ohm
Power Handling	150W
Crossover Point	3200Hz 6dB/octave
Crossover Controls	Tweeter level -3dB, 0dB, +3dB
Wiring Options	Standard
Housing Material	Black ABS
Terminal Type	Large screws gold plated
Net Weight	0.21kg (0.46lb)



www.morelhifi.com

# DOTECH OVATION 4/5/6

## Component Systems Installation Guide



www.morelhifi.com

## Content - Woofer

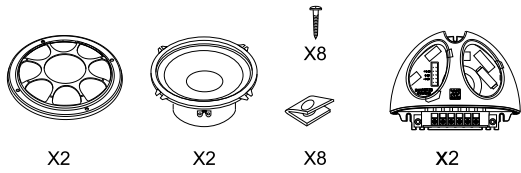

## Content tweeter

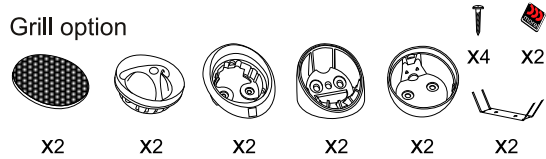

## Tweeter attenuation level

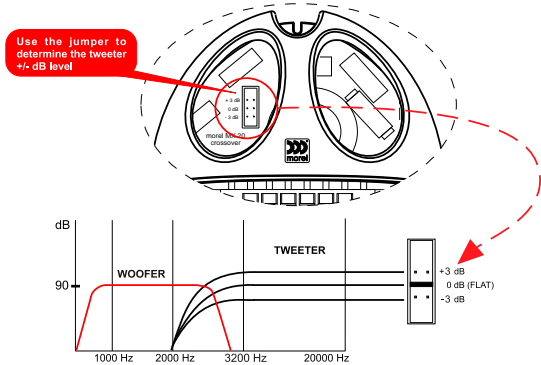

## Woofer mounting

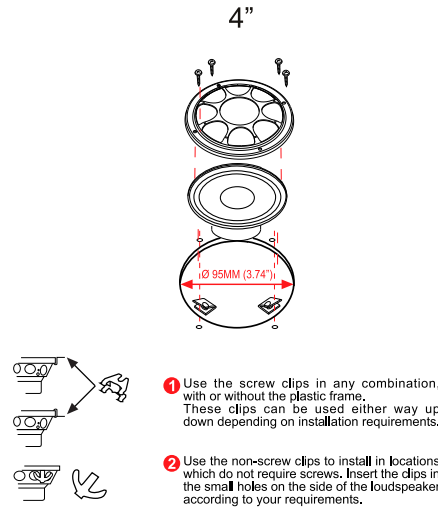

## Tweeter surface mounting option 1

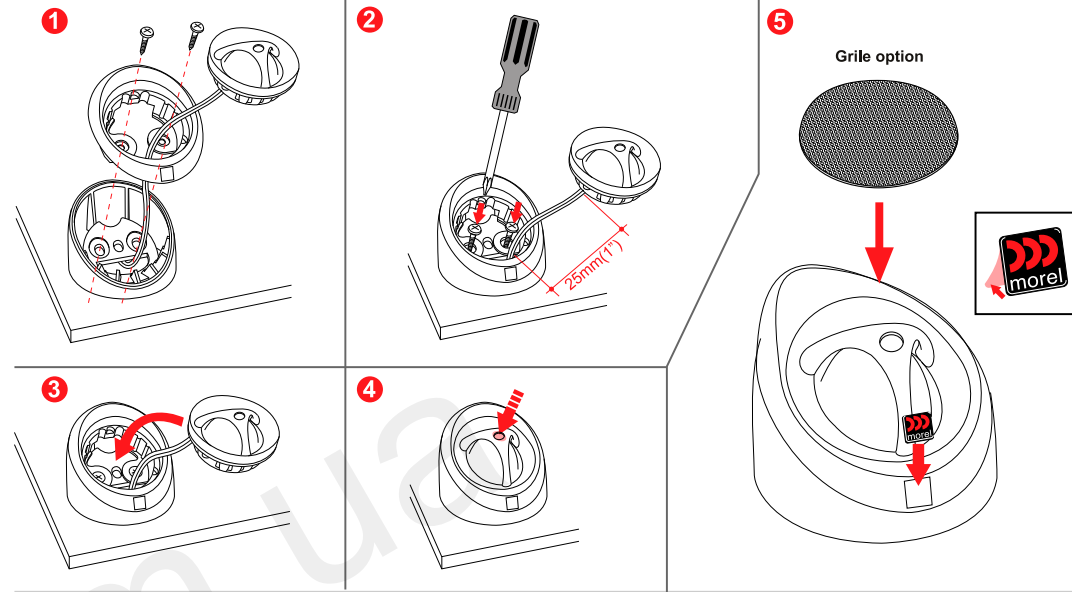

## Tweeter surface mounting option 2

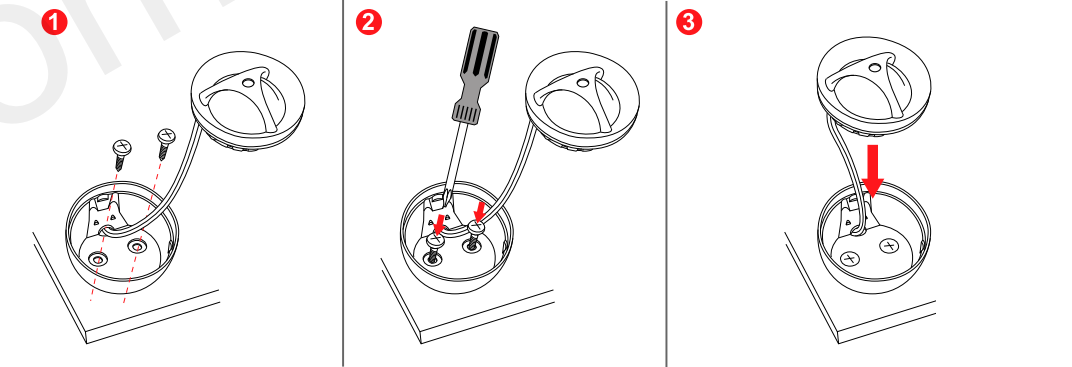

## Connection diagram

### Active setup

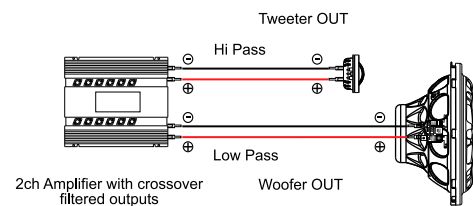

### Passive setup

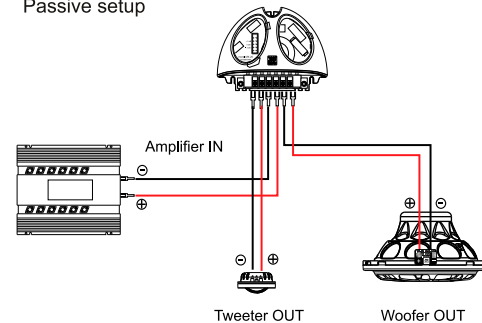

## Flush mount option

