



PHONES

0 (800) 800 130
(050) 462 0 130
(063) 462 0 130
(067) 462 0 130

130
COM.UA

Internet store of
autogoods



SKYPE

km-130

CAR RECEIVERS — Receivers • Media receivers and stations • Native receivers • CD/DVD changers • FM-modulators/USB adapters • Flash memory • Facia plates and adapters • Antennas • Accessories |
CAR AUDIO — Car audio speakers • Amplifiers • Subwoofers • Processors • Crossovers • Headphones • Accessories | TRIP COMPUTERS — Universal computers • Model computers • Accessories |
GPS NAVIGATORS — Portable GPS • Built-in GPS • GPS modules • GPS trackers • Antennas for GPS navigators • Accessories | VIDEO — DVR • TV sets and monitors • Car TV tuners • Cameras • Videomodules
• Transcoders • Car TV antennas • Accessories | SECURITY SYSTEMS — Car alarms • Bike alarms • Mechanical blockers • Immobilizers • Sensors • Accessories | OPTIC AND LIGHT — Xenon • Bixenon • Lamps
• LED • Stroboscopes • Optic and Headlights • Washers • Light, rain sensors • Accessories | PARKTRONICS AND MIRRORS — Rear parktronic • Front parktronic • Combined parktronic • Rear-view mirrors
• Accessories | HEATING AND COOLING — Seat heaters • Mirrors heaters • Screen-wipers heaters • Engine heaters • Auto-refrigerators • Air conditioning units • Accessories | TUNING — Vibro-isolation
• Noise-isolation • Tint films • Accessories | ACCESSORIES — Radar-detectors • Handsfree, Bluetooth • Windowlifters • Compressors • Beeps, loudspeakers • Measuring instruments • Cleaners • Car seats
• Miscellaneous | MOUNTING — Installation kits • Upholstery • Grilles • Tubes • Cable and wire • Tools • Miscellaneous | POWER — Batteries • Converters • Start-charging equipment • Capacitors
• Accessories | MARINE AUDIO AND ELECTRONICS — Marine receivers • Marine audio speakers • Marine subwoofers • Marine amplifiers • Accessories | CAR CARE PRODUCTS — Additives • Washer fluid •
Care accessories • Car polish • Flavors • Adhesives and sealants | LIQUID AND OIL — Motor oil • Transmission oil • Brake fluid • Antifreeze • Technical lubricant



In store "130" you can find and buy almost all necessary goods for your auto in Kyiv and other cities, delivery by ground and postal services. Our experienced consultants will provide you with exhaustive information and help you to chose the very particular thing. We are waiting for you at the address

<https://130.com.ua>



GTO-5EZ/GTO-3EZ

power amplifier



OWNER'S MANUAL

WHY YOU SHOULD PAY ATTENTION TO THIS OWNER'S MANUAL

The performance of your vehicle's audio system depends as much on quality installation and setup as it does on quality gear. Of course, these new JBL® GTO amplifiers are bulletproof performers that are built using the highest quality components, and will outperform any competing product on the test bench. To make sure you extract all the performance possible from your new amp, whether you install it yourself or have a professional install it for you, we've incorporated some new features that make setup simple and precise and ensure you get all the power and performance you've paid for.

WHAT MAKES THESE AMPLIFIERS DIFFERENT

All amplifiers include some signal processing functions, level setting controls and other switches and connectors that make it possible to hook the amp up to just about any existing system. However, with many amplifiers, considerable technical expertise is required to make the best use of those connectors, switches and controls to get powerful noise-free sound. JBL GTO amplifiers include Simple Setup designed to make it easy for you to get all the noise-free power your amp is capable of delivering.

WHAT MAKES INPUT SETUP EASY

GTO Amplifiers include adapters for connecting almost any analog signal and feature built-in Gain Indicator LEDs and a setup CD that makes precision adjustment simple, no matter your level of experience. The setup of GTO amplifiers is a little different than amplifiers you may have installed in the past, so **please read this owner's manual before you begin. If you're an experienced installer, skipping ahead is OK, but please don't skip Setup Procedure, on page 8.**

So we can better serve you should you require warranty service, please retain your original sales receipt and register your GTO-5EZ or GTO-3EZ online at www.jbl.com.

INCLUDED ITEMS

The following items are included in the packaging. If any of these items are missing, please contact your authorized JBL dealer, or JBL customer service at www.jbl.com.

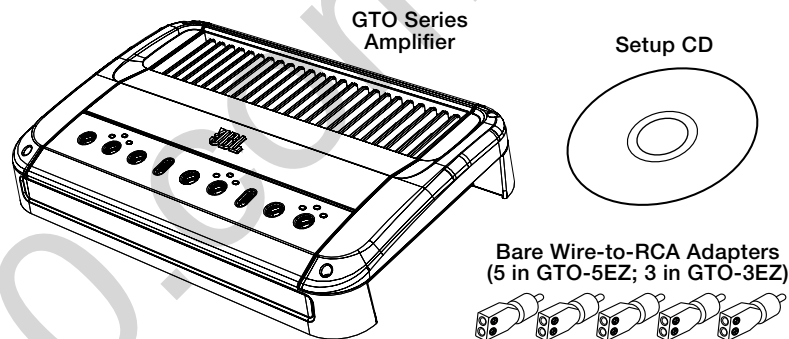

LOCATION AND MOUNTING

INSTALLATION WARNINGS AND TIPS

IMPORTANT: Disconnect the vehicle's negative (-) battery terminal before beginning the installation.

- Always wear protective eyewear when using tools.
- Check clearances on both sides of a planned mounting surface. Be sure that screws or wires will not puncture brake lines, fuel lines or wiring harnesses, and that wire routing will not interfere with the safe operation of the vehicle.
- When making electrical connections, make sure they are secure and properly insulated.
- If you must replace any of the GTO-5EZ/GTO-3EZ's fuses, be sure to use the same type of fuse and current rating as that of the original.

INSTALLATION LOCATION

Amplifiers need air circulation to stay cool. Select a location that provides enough air for the amp to cool itself.

- Suitable locations are under a seat (provided the amplifier doesn't interfere with the seat adjustment mechanism), in the trunk, or in any other location that provides enough cooling air.
- Do not mount the amplifier with the heatsink facing downward, as this interferes with the amplifier's convection cooling.
- Mount the amplifier so that it will not be damaged by the feet of backseat passengers or shifting cargo in the trunk.
- Mount the amplifier so that it remains dry – never mount an amplifier outside the car or in the engine compartment.

MOUNTING THE AMPLIFIER

NOTE: You may find it more convenient to make all of the connections to the amplifier before you permanently mount it to the vehicle.

Before mounting the amplifier you must remove the two end caps to expose the mounting holes and the connections. Using a Phillips screwdriver, remove the attachment screws and then the end caps, as shown in the illustration. Put the screws in a safe place, so you can use them to reattach the end caps after you have made all the connections to the amplifier.

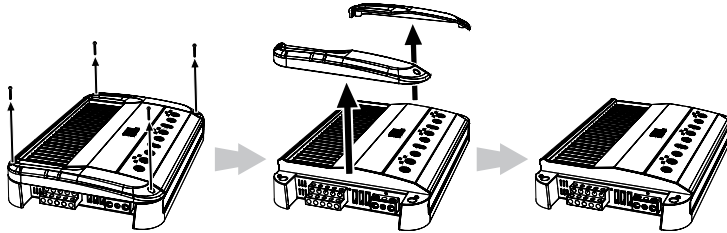

NOTE: Before you permanently mount the amplifier, read *Auto Turn-On Switch*, below, to determine the setting of the switch, which is located on the amplifier's bottom panel.

1. Select a suitable mounting location as described above.
2. Using the amplifier as a template, mark the locations of the mounting holes on the mounting surface.
3. Drill pilot holes in the mounting surface.
4. Attach the amplifier to the mounting surface with four appropriate mounting screws of your own choice. We suggest using #8 Phillips-head sheet metal screws. Make sure the amplifier is mounted securely.

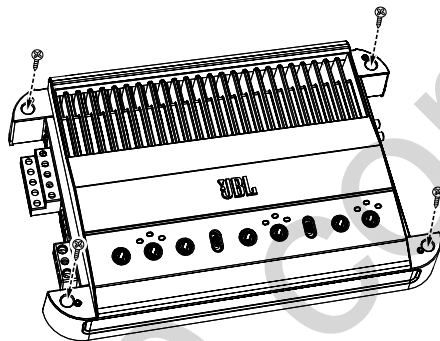

CONNECTIONS

IMPORTANT: Disconnect the vehicle's negative (-) battery terminal before beginning the installation.

If you have not already done so, remove the two end caps that cover the amplifier's connectors as explained in *Mounting the Amplifier*, above. This will provide easier access to all of the amplifier's connectors.

AUTO TURN-ON SWITCH

No remote turn-on connection is necessary because GTO amplifiers include signal-sensing turn-on, which will turn the amplifier on when it receives an audio signal at any of its input connectors. The amplifier will automatically turn off approximately five minutes after the input signal ceases.

If your audio system's source unit includes a remote turn-on wire and you would prefer to use it, the amplifier will sense that you've used a remote turn-on wire and that connection will override the signal-sensing turn-on. If necessary, you can defeat the signal-sensing turn-on circuit by moving the Auto Turn-On switch to the "Off" position.

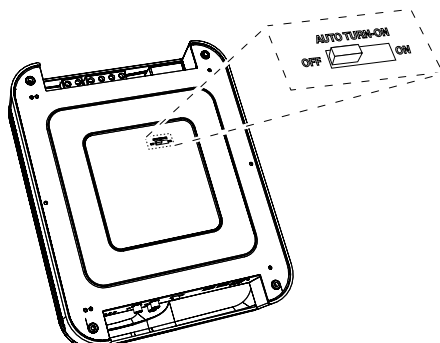

CONNECTING THE POWER AND GROUND

The GTO series amplifiers are capable of delivering extremely high power levels, and require a heavy-duty and reliable connection to the vehicle's electrical system to achieve optimal performance. Please adhere to the following instructions carefully.

Using the Connectors

GTO series amplifiers use the same type of screw terminals for power and speaker connections. This type of terminal is easy to use, provides superior current transfer and allows the easy connection of large-gauge wire.

To use the connectors, use a Phillips screwdriver to loosen the connector's set screw, insert the bare wire and tighten the set screw to secure the wire in the connector.

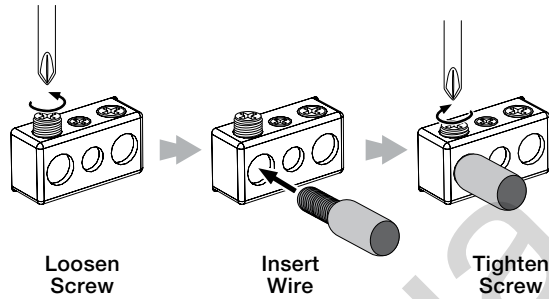

Ground Connection

Connect a wire (minimum 6AWG – 13.2mm² – for the GTO-5EZ; minimum 8AWG – 8.4mm² – for the GTO-3EZ) from the amplifier's GND terminal directly to a solid point on the vehicle's chassis. For a good connection, use sandpaper to clear the paint from the metal surface at this chassis location. Use a star-type lock washer to secure the wire's connection.

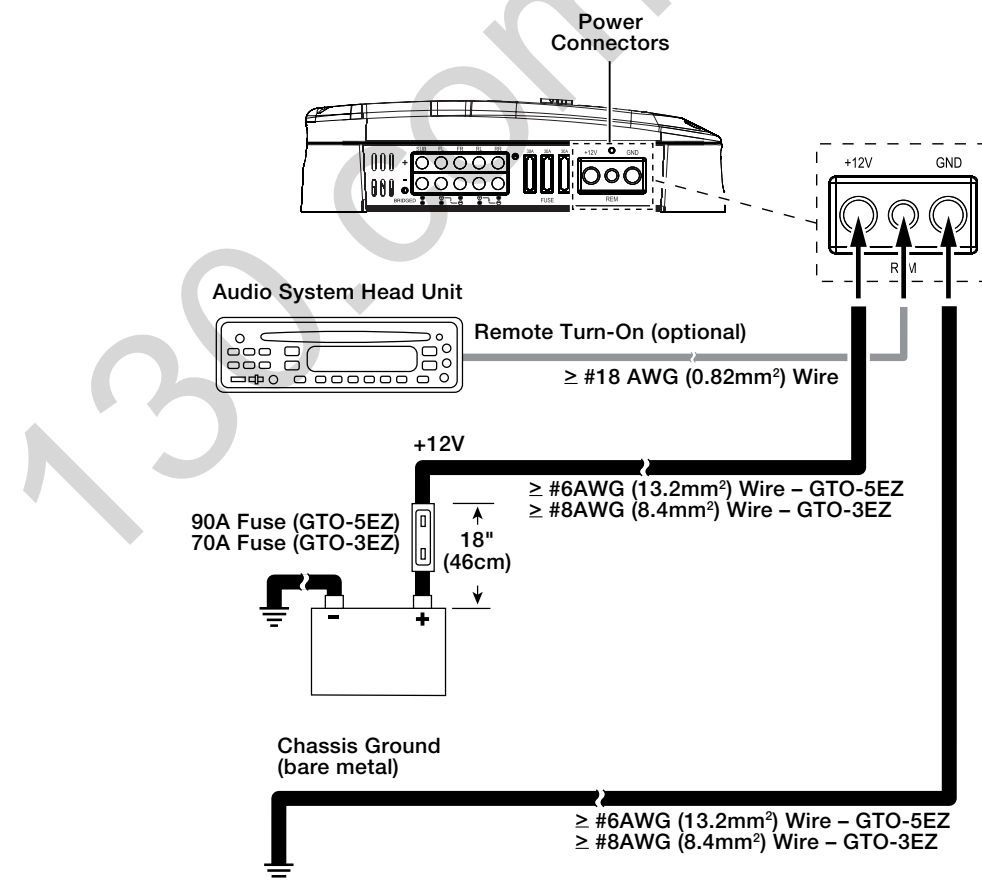

Power Connection

1. Connect a wire (minimum 6AWG – 13.2mm² – for the GTO-5EZ; minimum 8AWG – 8.4mm² – for the GTO-3EZ) directly to the battery's positive (+) terminal.
2. Install a fuse holder for a 90A fuse (GTO-5EZ) or 70A fuse (GTO-3EZ) on this wire within 18" (46cm) of the battery's (+) terminal. Do not install the fuse in the holder at this time.
3. Route this wire to the amplifier's location and connect it to the amplifier's +12V terminal. Be sure to use appropriate grommets whenever routing wires through the firewall or other sheet metal. **IMPORTANT:** Failure to adequately protect the positive wire from potential damage may result in a vehicle fire.
4. When you are finished routing and connecting this wire, install the appropriate fuse in the holder you installed near the battery. (GTO-5EZ = 90A fuse; GTO-3EZ = 70A fuse.)

SPEAKER CONNECTIONS

Always connect the (+) terminal on the amplifier to the (+) terminal on the speaker and the (–) terminal on the amplifier to the (–) terminal on the speaker.

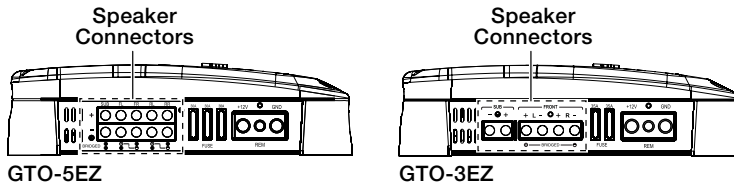

IMPORTANT: Make sure the (+) and (–) bare wires do not touch each other or the other terminal at both the amplifier terminals and speaker terminals. Touching wires can cause a short circuit that can damage the amplifier.

NOTE: The minimum speaker impedance for stereo operation is 2 ohms. The minimum speaker impedance for bridged operation is 4 ohms. The minimum subwoofer impedance is 2 ohms.

Stereo operation

- Connect the front speakers to the Front L (FL) and Front R (FR) (+) and (–) terminals.
- GTO-5EZ only: Connect the rear speakers, using the RL and RR (+) and (–) terminals.
- Connect the subwoofer to the Sub (+) and (–) terminals.

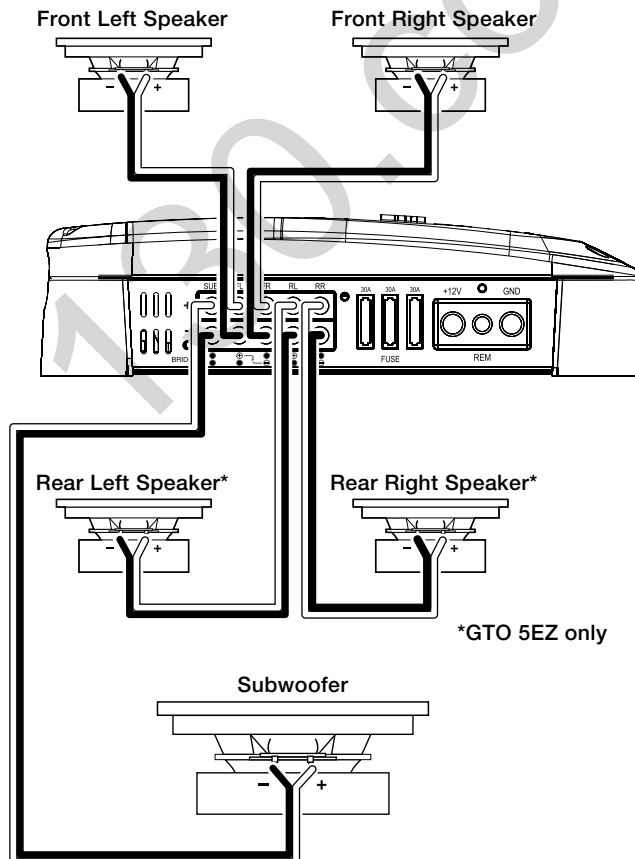

GTO-5EZ bridged operation (high-power for front speakers)

- Connect the left speaker to the FL (+) and FR (-) terminals
- Connect the right speaker to the RL (+) and RR (-) terminals.
- Connect the subwoofer to the Sub (+) and (-) terminals.

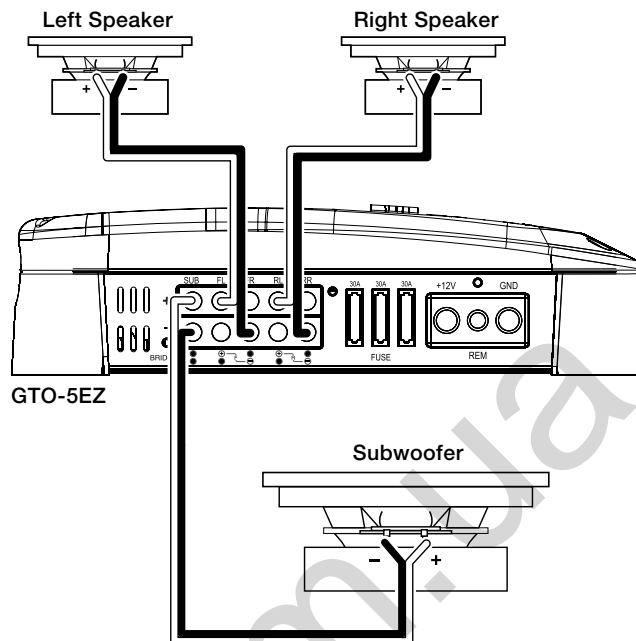

NOTE: You can also run one pair of left and right channels in stereo and the other pair of left and right channels bridged for a 3.1-channel system.

See *Connecting the Inputs*, on page 7, for information about connecting the inputs for bridged operation.

GTO-3EZ Bridged operation (center channel and subwoofer operation in a multichannel system)

- Connect one speaker to the L (+) and R (-) terminals.
- Connect the subwoofer to the Sub (+) and (-) terminals.

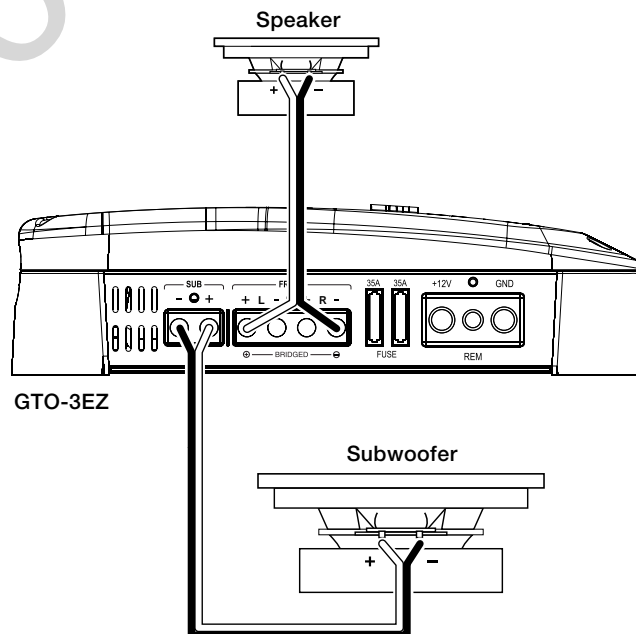

See *Connecting the Inputs*, on page 7, for information about connecting the inputs for bridged operation.

INPUT CONNECTIONS

The GTO-5EZ and GTO-3EZ amplifiers have multiple input connectors with routing switches that increase flexibility, so you can use these amps in a variety of audio system configurations.

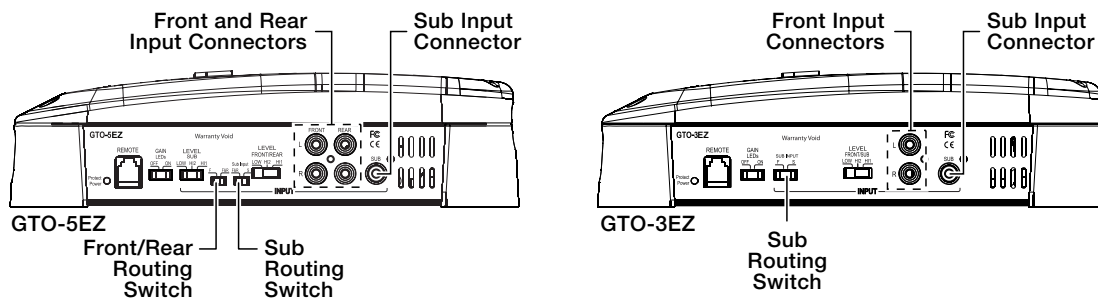

ROUTING SWITCHES

The GTO amplifier routing switches let you determine which input connectors drive the amplifier's various speaker outputs:

GTO-5EZ

Front/Rear Routing switch:

- F: The front and rear speaker outputs are both fed by the Front Input connectors.
- F&R: The front speaker outputs are fed by the Front Input connectors; the rear speaker outputs are fed by the Rear Input connectors.

Sub Routing switch:

- F&R: The Sub speaker output is fed by the Front and Rear Input connectors. (For use with source units that do not have a dedicated subwoofer connector.)
- S: The Sub speaker output is fed only by the Sub Input connector. (For use with source units that have a dedicated subwoofer connector.)

GTO-3EZ

Sub Routing switch:

- F: The Sub speaker output is fed by the Front Input connectors. (For use with source units that do not have a dedicated subwoofer connector.)
- S: The Sub speaker output is fed only by the Sub Input connector. (For use with source units that have a dedicated subwoofer connector.)

CONNECTING THE INPUTS

Use RCA audio cables to connect source units with preamp-level outputs to the amplifier; use the supplied bare wire-to-RCA adapters to connect to source units that don't have RCA output connectors.

Use a small Phillips screwdriver to loosen the adapter's set screws and insert the speaker wires into the holes on the back of the adapter. Tighten the set screws to secure the wires.

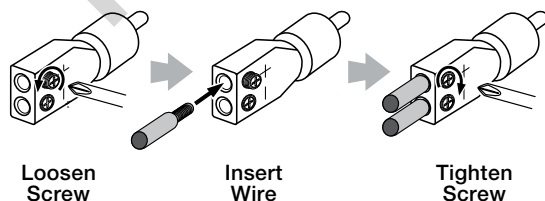

Always connect the (+) speaker wire to the (+) terminal on the adapter and the (-) speaker wire to the (-) terminal on the speaker.

IMPORTANT: Make sure the (+) and (-) bare wires do not touch each other. Touching wires can cause a short circuit that can damage the source unit or the amplifier.

When you're finished, plug the adapter into the appropriate input connector on the amplifier.

- For bridged operation: Connect to either the left or right input connectors if you wish to feed the amplifier a mono signal (such as the center channel from a processor that outputs a center channel signal), or connect to both inputs if you want the amplifier to create a mono signal for a single speaker.

SETUP PROCEDURE

GTO series amplifiers include a setup CD with test signals that makes it easy to precisely set the amplifier's input gain to maximize the amplifier's signal-to-noise and dynamic range performance with your vehicle's audio system. The amplifiers feature three Gain Indicator LEDs that provide all the feedback you need to quickly set the gain to the proper level.

CONTROLS

Before setting the amplifier controls: Confirm that all connections have been correctly made, reconnect the vehicle's negative (-) battery terminal and turn the audio system on.

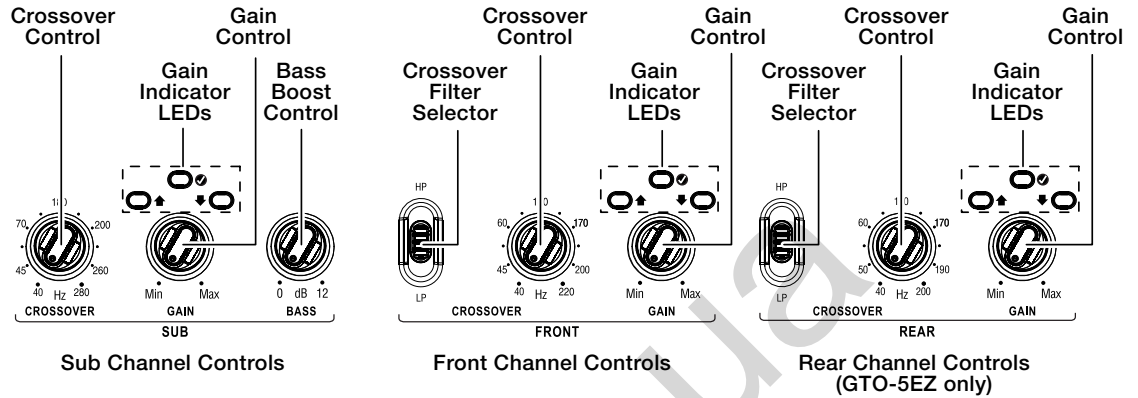

SET THE CROSSOVER

Before you set the amplifier's gain, we recommend that you set the Crossover controls for the speakers that you have connected to each of the amplifier's channels.

Crossover Filter Selector

The Crossover Filter Selector lets you configure the front (and rear – GTO-5EZ) channels for either high-pass, low-pass or full-range operation. The Sub channel crossover is permanently set for low-pass operation.

- **If you have connected a subwoofer or woofer to the amplifier channels:** Set the Crossover Filter selector in the "LP" (low-pass) position. This will limit the amount of high-frequency energy sent to the woofers or subwoofer.
- **If you have connected any other type of speaker to the amplifier channels:** Set the Crossover Filter selector in the "HP" (high-pass) position. This will limit the amount of low-frequency energy sent to the speaker, significantly reducing distortion and preventing the speaker from damage. **Exception:** If you have connected large full-range speakers (6" x 9" or larger) that can handle significant bass to the amplifier channels *and you are not using a subwoofer in the system*, set the Crossover Filter selector for full-range operation (the switch's center position).

Crossover Control

The Crossover control determines the frequency where the low frequencies or high frequencies sent to the speakers begin to be reduced in volume.

- **High-pass operation:** For high-pass filters, you should set the Crossover control according to the size of the speakers connected to the amplifier channels – the smaller the speakers the higher you need to set the control to protect the speaker from damage. The illustration below shows the acceptable crossover filter frequency ranges for different speaker sizes.

6-Inch and 5-Inch Speakers

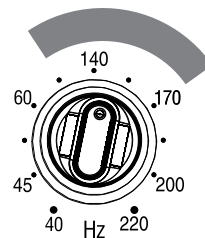

4-Inch and Smaller Speakers

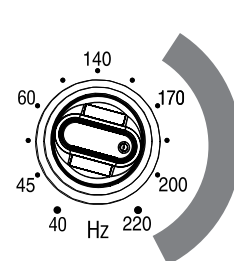

After initially setting the crossover frequency, listen to music with strong bass that you are familiar with. If the speakers sound distorted or distressed, move the crossover frequency control to a higher setting to eliminate the distortion/distress.

- Low-pass operation:** The low-pass Crossover control setting you use for subwoofers will depend partly on the settings you use for the system's high-pass channels (see above) and partly on the type and location of your system's subwoofer. Start by setting the Crossover control to a frequency somewhat lower than the lowest setting you used on any of the high-pass channels. After listening to music on the system for a time, fine-tune the low-pass Crossover control setting to achieve a smooth transition from the subwoofer to the rest of the system's speakers while avoiding a "hole," where the sounds that occur between the subwoofer and other speakers seem to drop out. The illustration below shows the acceptable low-pass Crossover control frequency range.

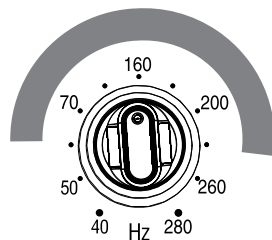

SET THE GAIN

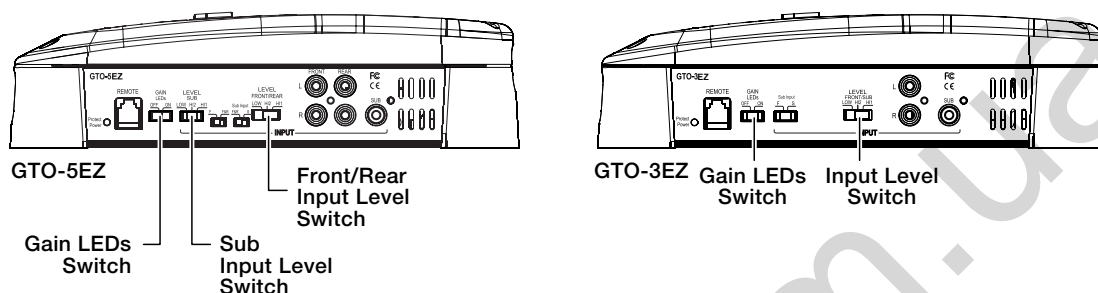

Before beginning, make sure the Gain LEDs switch is set to the "On" position.

- Initially set all amplifier Input Level switches to the "Hi1" position.

NOTE: If you have connected the GTO-5EZ or GTO-3EZ amplifier to your factory audio system's speaker outputs, the audio system may show a "speaker disconnected" message, or may fail to play with an amplifier connected to its output. If this happens, set the GTO amplifier's Input Level switch to the "Hi2" position. The "Hi2" position includes a circuit designed to fool this type of factory system into "seeing" a speaker connected to its output.

- Turn all amplifier Gain controls to the "Min" setting.
- If you have connected an RBC Remote Bass Control (sold separately), set its knob to 3/4 (clockwise) before performing the rest of the procedure. This will allow you to use the control to boost or attenuate the subwoofer after you have completed setup.
- Play the supplied setup CD through the vehicle's audio system.
- Set the audio system head unit's volume to maximum (all the way up).
- SLOWLY advance the Gain control setting. The Gain Indicator LEDs will light up:
 - Yellow LED = Gain is too low
 - Green LED = Gain is OK
 - Red LED = Gain is too high
- SLOWLY advance the Gain control so that the green Gain Indicator LED lights up. If you overshoot and the red LED lights up, turn the Gain control down so that the yellow LED lights up and advance the Gain control SLOWLY until the green LED lights up.

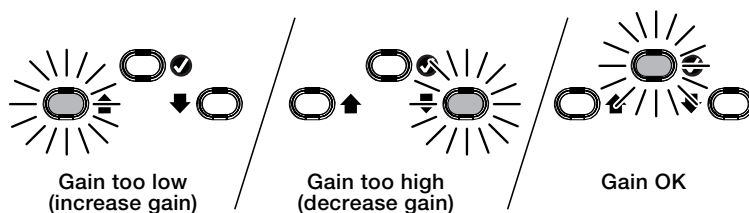

NOTE: If you advance the Gain control all the way and the yellow LED is still lit up, turn the Gain control to "Min," switch the Input Level switch to the "Low" position and repeat Step 6.

- Repeat Steps 5 and 6 for all of the amplifier channels. When all Gain Indicator LEDs are lit green, the GTO amplifier gain setup is complete.

NOTE: Set the amplifier's Gain LEDs switch to the "Off" position to prevent the red LEDs from lighting up continually during normal operation.

BASS BOOST

The Bass Boost control provides up to 12dB of bass boost at 45Hz. Set this control according to your personal taste, but be careful not to set the control at a high enough level to cause audible distortion or bottoming of your subwoofer.

POWER/PROTECTION LED

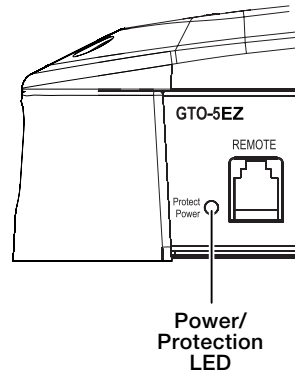

The GTO amplifier Power/Protection LED's color indicates the amplifier's operational status:

LED is orange: Normal operation (power is on)

LED is off: Amplifier is in standby mode

LED is red: Amplifier is in protect mode

If the amplifier is in the protect mode (the LED is red), see *Troubleshooting*, below.

TROUBLESHOOTING

If your amplifier isn't performing the way you think it should, check to see if the problem is covered in this section before calling your dealer or contacting JBL customer service.

PROBLEM

CAUSES AND SOLUTIONS

No sound (the amplifier's Power/ Protection LED is off):

- Check that the amplifier's +12V and GND connections have been properly made.
- Check if the fuse on the +12V wire located near the battery is blown; if so, replace it with an identical fuse.
- Check all amplifier fuses; if any are blown, replace them with identical fuses.
- If you are using the amplifier's REM connection for turn-on, check that the wire is properly connected to the audio system's remote turn-on wire or to the vehicle's ACC power terminal.
- If you are using the amplifier's Auto Turn-On circuit for turn-on, check that the amplifier's Auto Turn-On switch (on the amplifier's bottom panel) is set in the "On" position.

No sound (the amplifier's Power/ Protection LED is orange):

- Check that all amplifier input and speaker connections have been properly made.
- Check that the amplifier's Gain controls are not turned all the way down.
- Check that the vehicle audio system's source unit's volume control is not turned all the way down.

No sound (the amplifier's Power/ Protection LED is red):

- Confirm that the vehicle's electrical system is supplying between 9V and 16V DC to the amplifier. If the supply voltage is outside of this range, correct the condition before attempting to use the amplifier.
- If the amplifier has overheated, wait until it has cooled down before attempting to use it again.
- Disconnect all speakers from the amplifier and attempt to turn it on again:
 - If the amplifier turns on (the Power/Protect LED is orange), there is a short circuit in one or more of the speaker wires. Correct all short circuits before reconnecting the speakers to the amplifier.
 - If the amplifier does not turn on (the Power/Protect LED is still red), contact your authorized JBL dealer for assistance.

PROBLEM**CAUSES AND SOLUTIONS**

Sound only comes from some of the speakers connected to the amplifier:

- Check that the settings of the amplifier's Input Routing switches match the input and speaker connections made to the amplifier.
- Check that the vehicle audio system's source unit's balance and fader controls are set to their center (midpoint) positions.
- If the subwoofer is silent and the optional Remote Bass Control is connected to the amplifier, check that it is not turned all the way down (fully counterclockwise).

Sound is too quiet, even with the vehicle audio system's head unit volume turned all the way up:

- Check the amplifier's Input Level switches. If they are set to "Hi1," turn the amplifier's Gain controls all the way down and re-set the Input Level switches to "Low." Then perform the *Set the Gain* procedure, on page 9, again.

Sound in the front/rear speakers is distorted:

- If the amplifier channels' Input Level switch is set in the "Low" position, change the setting to "Hi1" and perform the *Set the Gain* procedure, on page 9, again for those channels.
- Make sure amplifier's Crossover Filter selector for the distorted channels is set to HP.
- Set the distorted channels' Crossover control to a higher setting.
- Check that the distortion is not originating from the vehicle audio system's source unit.

Sound in the subwoofer is distorted:

- If the amplifier Sub channel's Input Level switch is set in the "Low" position, change the setting to "Hi1" and perform the *Set the Gain* procedure, on page 9, again for those channels.
- While listening to bass-heavy music, turn the Bass Boost control all the way down, and then gradually increase it until the distortion begins to return. Reduce the Bass Boost control setting slightly to eliminate the distortion and leave it set there.
- Check that the distortion is not originating from the vehicle audio system's source unit.

GTO-5EZ only: The vehicle audio system's source unit's fader control has no effect:

- Make sure that the amplifier's Front/Rear Input Routing switch is set in the "F&R" position.

The vehicle audio system's subwoofer volume control does not control the subwoofer's volume:

- Make sure that the amplifier's Sub Input Routing switch is set in the "S" position.

The amplifier's Gain LEDs constantly illuminate red while the amplifier is operating:

- Set the amplifier's Gain LEDs switch in the "Off" position.

SPECIFICATIONS

GTO-5EZ

Number of Channels:	4 + 1
Power Output (CEA 2006A):	50W RMS x 4 channels at 4 ohms + 350W RMS x 1 channel at 4 ohms, 14.4V DC, <1.0% THD 75W RMS x 4 channels at 2 ohms + 500W RMS x 1 channel at 2 ohms, 14.4V DC, <1.0% THD 150W RMS x 2 channels bridged at 4 ohms + 500W RMS x 1 channel at 2 ohms, 14.4V DC, <1.0% THD
Max Power:	1935W: 1075W x 1 channel at 2 ohms (50Hz) + 215W x 4 channels at 2 ohms (1kHz), 15.5V DC, 10% THD
Frequency Response:	20Hz – 23kHz (±0.5dB) front and rear channels; 10Hz – 280Hz (±3dB) sub channel
Crosstalk:	> 50dB @ 1kHz
Signal-to-Noise (@ 1W):	> 85dB
Maximum Current Draw:	100A
Fuse Replacement:	30A x 3
Dimensions (D x H x W):	14-11/16" x 2-9/16" x 9-11/16" (373mm x 66mm x 246mm)
Weight:	11.2 lb (5.1kg)

GTO-3EZ

Number of Channels:	2 + 1
Power Output (CEA 2006A):	50W RMS x 2 channels at 4 ohms + 350W RMS x 1 channel at 4 ohms, 14.4V DC, <1.0% THD 75W RMS x 2 channels at 2 ohms + 500W RMS x 1 channel at 2 ohms, 14.4V DC, <1.0% THD 150W RMS x 1 channel bridged at 4 ohms + 500W RMS x 1 channel at 2 ohms, 14.4V DC, <1.0% THD
Max Power:	1370W: 1050W x 1 channel at 2 ohms (50Hz) + 160W x 2 channels at 2 ohms (1kHz), 15.5V DC, 10% THD
Frequency Response:	20Hz – 23kHz (±0.5dB) front and rear channels; 10Hz – 280Hz (±3dB) sub channel
Crosstalk:	> 50dB @ 1kHz
Signal-to-Noise (@ 1W):	> 85dB
Maximum Current Draw:	65A
Fuse Replacement:	35A x 2
Dimensions (D x H x W):	11-15/16" x 2-9/16" x 9-11/16" (302mm x 66mm x 246mm)
Weight:	9.0 lb (4.1kg)



130.com.ua

HARMAN HARMAN Consumer, Inc.
8500 Balboa Boulevard, Northridge, CA 91329 USA

© 2011 HARMAN International Industries, Incorporated. All rights reserved.

JBL is a trademark of HARMAN International Industries, Incorporated, registered in the United States and/or other countries.

Features, specifications and appearance are subject to change without notice.