



PHONES

(044) 360-7-130
 (050) 336-0-130
 (063) 788-0-130
 (067) 233-0-130
 (068) 282-0-130

130 Internet store of autogoods

COM.UA



ICQ
 294-0-130
 597-0-130

SKYPE
 km-130

CAR RECEIVERS — Receivers • Media receivers and stations • Native receivers • CD/DVD changers • FM-modulators/USB adapters • Flash memory • Facia plates and adapters • Antennas • Accessories |
 CAR AUDIO — Car audio speakers • Amplifiers • Subwoofers • Processors • Crossovers • Headphones • Accessories | TRIP COMPUTERS — Universal computers • Model computers • Accessories |
 GPS NAVIGATORS — Portable GPS • Built-in GPS • GPS modules • GPS trackers • Antennas for GPS navigators • Accessories | VIDEO — DVR • TV sets and monitors • Car TV tuners • Cameras • Videomodules
 • Transcoders • Car TV antennas • Accessories | SECURITY SYSTEMS — Car alarms • Bike alarms • Mechanical blockers • Immobilizers • Sensors • Accessories | OPTIC AND LIGHT — Xenon • Bixenon • Lamps
 • LED • Stroboscopes • Optic and Headlights • Washers • Light, rain sensors • Accessories | PARKTRONICS AND MIRRORS — Rear parktronic • Front parktronic • Combined parktronic • Rear-view mirrors
 • Accessories | HEATING AND COOLING — Seat heaters • Mirrors heaters • Screen-wipers heaters • Engine heaters • Auto-refrigerators • Air conditioning units • Accessories | TUNING — Vibro-isolation
 • Noise-isolation • Tint films • Accessories | ACCESSORIES — Radar-detectors • Handsfree, Bluetooth • Windowlifters • Compressors • Beeps, loudspeakers • Measuring instruments • Cleaners • Carsits
 • Miscellaneous | MOUNTING — Installation kits • Upholstery • Grilles • Tubes • Cable and wire • Tools • Miscellaneous | POWER — Batteries • Converters • Start-charging equipment • Capacitors
 • Accessories | MARINE AUDIO AND ELECTRONICS — Marine receivers • Marine audio speakers • Marine subwoofers • Marine amplifiers • Accessories | CAR CARE PRODUCTS — Additives • Washer fluid •
 Care accessories • Car polish • Flavors • Adhesives and sealants | LIQUID AND OIL — Motor oil • Transmission oil • Brake fluid • Antifreeze • Technical lubricant



In store "130" you can find and buy almost all necessary goods for your auto in Kyiv and other cities, delivery by ground and postal services. Our experienced consultants will provide you with exhaustive information and help you to chose the very particular thing. We are waiting for you at the address

<http://130.com.ua>



How to install and operate the X-program amplifiers

X-D10
X-D20
X-D25
X-D30
X-D40



Welcome!

This owners manual is written in easy english and uses a lot of drawings to simply the installation and use of the above amplifiers.

Your X-program amplifiers must be installed correctly in order to work well. This manual will show you how to install the amplifier like a pro. Please read the entire manual before beginning the installation. Install the amplifier yourself if you feel confident with our instructions and if you have the proper tools. However if you feel unsure, turn over the installation job to someone better suited to it.

Warranty Service

This amplifier is covered by warranty, depending on the conditions in the country where it is sold. If the amplifier is returned for service, please include the original dated receipt with the product.



Technical Assistance

For technical assistance ask the shop where the product was sold or the distributor in your very country. Information can also be found on our WEB-site www.xprogram.com

We follow a policy of continuous advancement in development. For this reason all or part of specifications & designs may be changed without prior notice.

DECLARATION OF CONFORMITY

X-program amplifiers for vehicles are manufactured in accordance with the EU directive EEC 95/54 (72/245/EEC) and are marked with the approval number. They are also marked in accordance with the WEEE-directive 2002/96/EC.

The products are also produced in accordance with the EU RoHS directive 2002/95/EC.

Contents

Features.....	2
Installation.....	2
Tools and materials needed.....	3
Amplifier installation kit.....	3
Routing Wires.....	3

Wiring

Power and Outputs.....	4
Inputs and controls.....	5
High and low level inputs.....	5
Input level control.....	6
Bass boost, Crossovers, etc.....	6
Crossovers / features on each model	7

X-D10 speaker wiring:

Subwoofer.....	8
----------------	---

X-D20 / D25 speaker wiring:

Front speakers.....	9
Subwoofer.....	9

X-D30 speaker wiring:

Two speakers and subwoofer.....	10
---------------------------------	----

X-D40 speaker wiring:

Four speakers.....	11
Two speakers and bridged subwoofer	11
Connection of subwoofers.....	12

Testing.....	13
Troubleshooting.....	13
Professional tips.....	14
Specifications.....	15



This product must be returned to the separate collection system for electronic products. Do not dispose this product together with general household waste.

X-program is designed, engineered and distributed by:

DLS Svenska AB

P.O. Box 13029 - SE-40251 Göteborg - Sweden

Tel: +46 31 840060 - Fax: +46 31 844021

E-mail: info@dls.se

www.xprogram.com

X-program products are produced in Taiwan



The models include

- Digital class D technique
- High efficiency
- Low profile design
- RCA line inputs
- RCA line outputs (not X-D30 / X-D40)
- High level input with Auto start
- Bass boost 0 - +18 dB
- Phase shift control (not X-D40)
- Powerful cable terminals
- Built-in active crossovers

Installation

Before you begin installation

Before you begin you need to read the manual, to have some tools, cables and other material available. There is one such list of material on the following page.

Amplifier location

Important

Allow air circulation around the amplifier.

The X-program series of amplifiers have a compact design that allows great flexibility in mounting. You can mount it under a seat or in the trunk. When you select a location, do remember that the amplifier generates a lot of heat.

Choose a location where air can circulate freely around the amplifier. Do not cover the amplifier with carpets or hide behind trim panels. Do not mount the amplifier in an inverted or upside down position.

Check all locations and placements carefully before making any cuts, drilling any holes or making any connections.

Disconnect Battery

Before starting the installation, always disconnect the negative terminal of the battery.

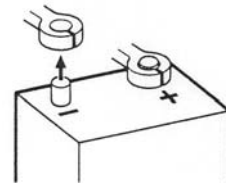

X-logo on amplifier cooling flange

The X-logo on the amplifier top is attached with two 1 mm hex. screws. The logo can be removed and twisted 90 or 180 degrees, and then screwed back in wanted position. The logo can be mounted in four different ways to match your installation.

Mounting

Fasten the amplifier to the surface using the four separate brackets coming with the amplifier. The brackets are attached to the amplifier with screws and can be directed in two ways, see figure:

Mount the flanges this way, or this way.

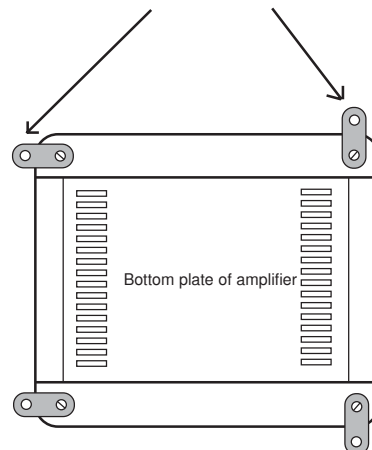



Tools and material needed

Tools:

- ◆ Flat and Phillips screwdrivers
- ◆ Wire cutter
- ◆ Wire stripper
- ◆ Electric drill with drills
- ◆ Crimping tool
- ◆ Digital multimeter or test lamp
- ◆ Wire brush, scraper or a piece of an abrasive sheet to remove paint for a good ground connection
- ◆ Grease to protect the ground connection from oxidation

Material:

- ◆ Speaker wire: minimum 12 AWG = 4 mm² for subwoofers 13 – 16 AWG = 1,5-2,5 mm² for other speakers
- ◆ Sheet metal screws for mounting the amplifier to the amplifier board and the amplifier board to the car + some extra for fuse holder, amplifier ground etc.
- ◆ Electrical insulation tape
- ◆ ½ inch thick plywood or particle board for the amplifier to be mounted upon.

Amplifier installation kit:

If available, buy an amplifier installation kit. It contains normally all you need. This is what you have to buy if you buy the items separately

- ◆ 20- 25 feet = 6- 7.5 meter power cable, minimum AWG 5 = 16 mm² or heavier
- ◆ 1 pc of fuseholder to install close to the car battery + fuse 50 Ampere.
- ◆ 20 feet of AWG 15 = 1,5 mm² wire for remote turn on / off cable from radio.
- ◆ RCA-cable for input from radio.
 - 20 feet or 5 meter for trunk installations
 - 12 feet or 2 – 3 meter for under seat installations.
- ◆ Four to eight splicers to connect speaker cables to high level input cable, if high level input is used.
- ◆ Wire ties
- ◆ Insulating grommet or insulating tube

Routing wires

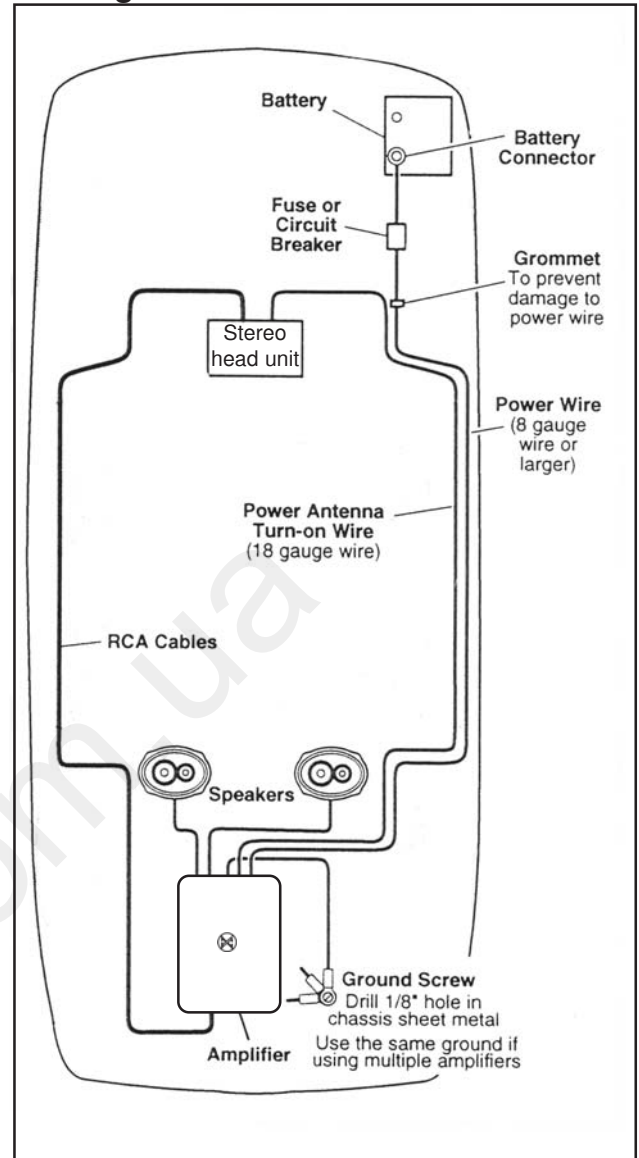

Professional Tip:

If amplifier installation kits are available with different size of power cable, chose the most heavy power cable to improve sound quality and to allow more amplifiers to be installed now or later.

The amplifier power terminals accept AWG 4 cables directly, so If possible buy AWG 4 = 21 mm² cable for best performance.

Both the positive wire and the ground wire must have the same size. To avoid cable fire, be sure not to oversize the main fuse value for the power wires.

THE DC-FEED

Maximum main fuse values for different cable sizes.

6 mm ² (9 AWG)	:25 A	10 mm ² (7AWG)	:40 A
16 mm ² (5AWG)	:60 A	21 mm ² (4AWG)	:100 A
33 mm ² (2AWG)	:150 A	42 mm ² (1AWG)	:200 A



Wiring

Power and Outputs

Power terminal (+12V)

Connect the fuse holder as close to the vehicle battery + as possible, using AWG 4 = 21 mm² power cable. Use a ring crimp terminal cable to connect to battery +. Apply silicon grease to the fuse to prevent corrosion. The AWG4 cable can use an 80 Amp fuse, if the cable is smaller, the fuse value must be lower (see table on previous page).

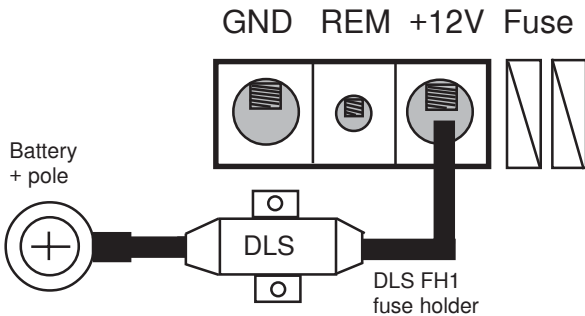

A cable up to AWG 4 fits directly in the amplifier + 12 V terminal, tighten with the hex screw.

Be sure to use a rubber grommet or a plastic insulating tube where the cable passes the firewall or other places where it can be easily jammed. Use wire ties to secure to existing cables in the engine compartment.

Ground Terminal (GND)

Connect to a good chassis ground. The ground connection should be clean, unpainted metal to provide a good electrical connection. Use a wire brush, a scraper or a piece of an abrasive sheet to clean the metal. Use a lock washer or two to secure contact. Protect with silicon grease or by paint applied afterwards.

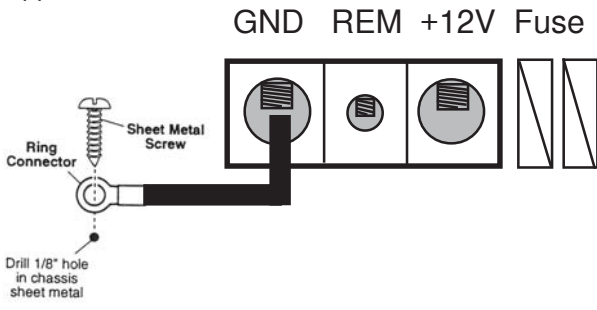

Fuses

Use only 25 ampere ATC blade type fuses when replacing a blown fuse.

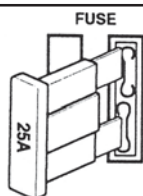

Remote terminal (REM)

For RCA cable signal input:

Connect the radio power antenna lead = remote turn on/off from the car stereo to the amplifier remote connection. This turns on the amplifier whenever the car stereo is turned on.

You can either use the built in remote cable in the RCA cable itself or use a separate cable.

Sometimes a small disturbance may enter the amplifier coming from the remote voltage, through the built in remote wire and into the RCA cable. Thus we recommend to use a separate remote wire and run the RCA lead separate from remote wire, power cables and speaker cables.

You can insert the cable directly into the amplifier terminal. If there is no remote voltage available from the stereo, you must connect to the ignition key through the radio or any accessories fuse.

For High Level input:

We recommend you to connect the remote wire as described above. The amplifier will produce soft on / soft off operation this way.

In the case that there is no remote voltage available from the car stereo or you want to simplify the installation, the amplifier can be turned on/ turned off by the high level input voltage. This is done automatically when the head unit is turned on. There is a small disadvantage that this function gives soft turn on operation but some pop sound when switching off.

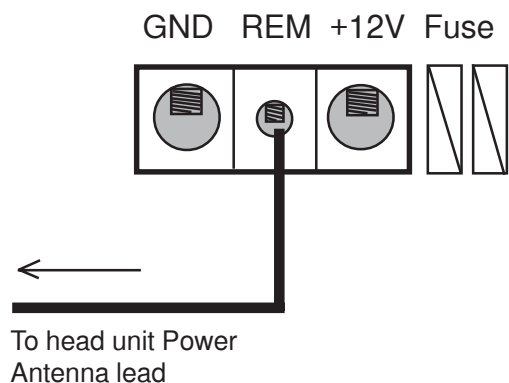

Power Light / Protect light

The power light (green) comes on when the amplifier is turned on.

● Power (Green)

The protect light (red) comes on when the amplifier shuts down from overheating, or a short circuit (speaker failure)

● Protect (Red)



Input and controls

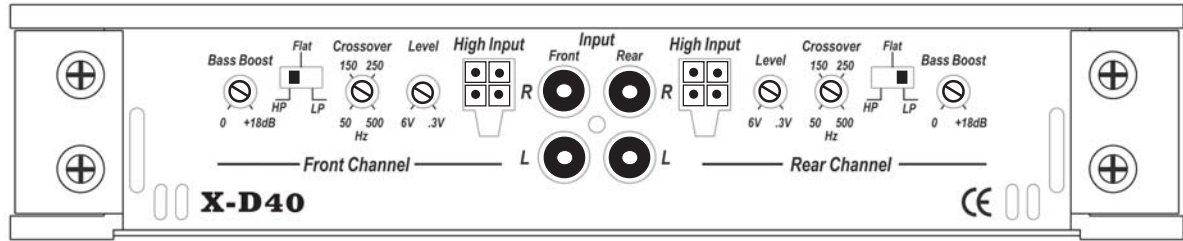

Low level Input Wiring

Inputs may be low level from the RCA output of the car stereo or high level from the car stereo speaker output. Low level = RCA is to prefer for the best sound quality.

Important

Use either the low level or high level input, do not use both at same time.

Low level input

Use a pair of shielded stereo audio cables with RCA type jack. Most trunk-mount amplifiers need a 20 feet RCA cable (appr 5 – 6 meters). Most under the seat installations require 12 feet (2 – 3 meters) RCA cables. Avoid placing the RCA cable close to speaker cables, power cables and remote control cable. Connect to input socket R/L.

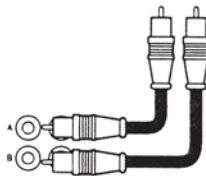

X-D40 has dual inputs Front R/L & Rear R/L. Depending on your chosen configuration you can use either two separate RCA cable, or a single RCA cable together with an Y-split to connect both inputs.

X-D30 has dual inputs, one for the stereo channels (Input R/L), and one for the mono channel (Sub Input R/L), both inputs must be connected on the mono channel input socket.

Parallel input on X-D30

If you don't have dual line cables to front and sub Input you can use a single line cable. Connect to the stereo input sockets and set the Parallel input switch to position P-sub and the signal is fed to the Sub input socket automatically.

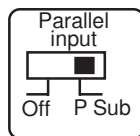

RCA Output on X-D10, X-D20, X-D25

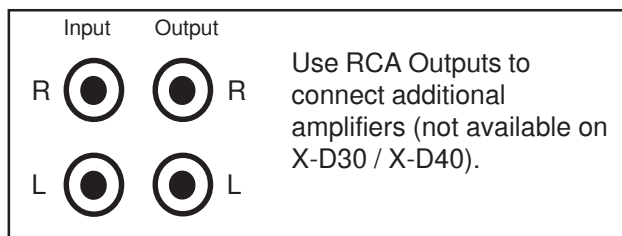

High Level Input wiring

Connect left and right speaker wires coming from the car stereo to the high level input as shown. You must connect both plus and minus as the inputs are balanced, connecting plus only gives lower level and bad sound quality. By changing the polarity of plus and minus, you can change the phase.

X-D10/20/25/30

On these models you connect as in this example:

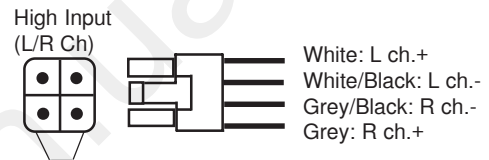

X-D30

On X-D30 the high level signal is fed internally to channel SUB when using high level input.

X-D40

The four channel amplifier is connected likewise, however we have four channels. You can feed two channels from RCA and two channels using high level input from rear speaker cables.

High level input socket

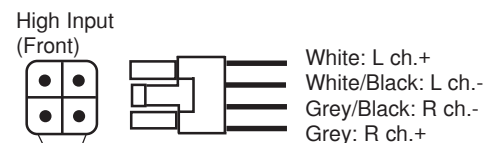

Hi level input plug on amp for CH L/R.

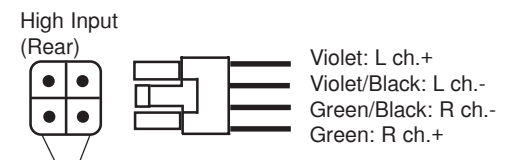

Hi level input plug on amp for CH L/R.

Automatic turn on when using high level input.

The amplifier turns on automatically when using high level input, you dont need to connect a separate remote wire from your head unit.

For a soft turn ON /OFF operation we recommend you to use a remote wire, if this is available.



Input Level control

The input level control, 6V – 0,3 V, matches the output of your radio to the input of the amplifier. After installation is complete, make sure the input of the amplifier is turned down all the way (counter-clockwise at 6V).

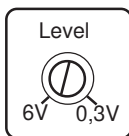

Play a CD, make sure all bass or treble settings or equalizer are flat, and turn the volume of the radio up until you just start to hear distortion. Turn the volume control down just a bit. On the amplifier increase the input level control (clockwise or to the right) until you just start to hear distortion, then back the level control just a bit. Now your radio and amplifier levels are matched.

Bass boost XD10, XD20, XD25, XD40

Bass boost is used to increase the bass volume at a low frequency. frequencies. You can select the amplification between 0 dB (no amplification) and +18 dB (full amplification).

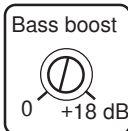

This function is used to compensate for the bass box function and to adjust for your own taste of bass. Set level control at 0 dB if you want it to be inoperative.

Phase control X-D10, D20, D25, D-30

The phase control can be set continuously from 0 - 180 degrees.

This function is used together with subwoofers. This is very useful when you want to adjust the bass sound for best front stage image. Start at 0 and turn the control slowly clockwise until you experience that the bass sound is coming from the front. If you don't get the result you want, also try to phase reverse the subwoofer connections and make a new adjustment.

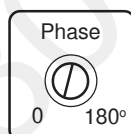

On models **X-D20, X-D25** the phase control and LP-filter can be switched on-off.

Subsonic filter X-D20, X-D25

The **Subsonic filter** blocks the very deepest frequencies from reaching the subwoofers. It can be set from 15 to 150 Hz and can be switched on / off. A typical setting for subwoofer use is 25-30 Hz

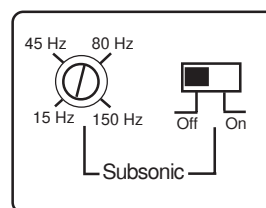

Subsonic filter X-D30

The **Subsonic filter** blocks the very deepest frequencies from reaching the subwoofers. It can be switched on / off. The cutoff frequency is 25 Hz.

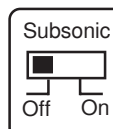

High Pass filter X-D30, X-D40

The high pass filter blocks very low frequencies from reaching the speakers. It is mostly used at say 60 Hz to protect small speakers (like 6 inch and smaller) from deep bass.

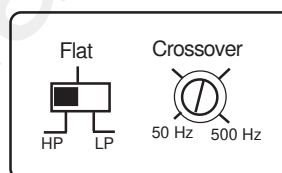

Set the switch in position HP to activate the filter. The filter can also be used as subsonic filter to remove the very deepest frequencies from a bass box. The typical setting is then around 25 – 50 Hz. The slope of the High Pass filter is 12 dB / octave. The filter can be switched off (position Flat) if you want to run the amplifier in full range mode.

Low Pass filter X-D10, D20, D25, D30

The low pass filter is mostly used for subwoofers. It will allow low frequencies only and blocks higher frequencies. A typical setting is 50 – 70 Hz.

On X-D30 the frequency is variable from 30 Hz to 150 Hz.

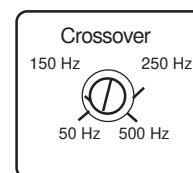

Low Pass filter X-D40

The low pass filter is mostly used for subwoofers. It will allow low frequencies only and blocks higher frequencies. A typical setting is 50 – 70 Hz.

Set the switch in position LP to activate the filter. Set the filter switch in FLAT position if you want to run the amplifier in full range mode.

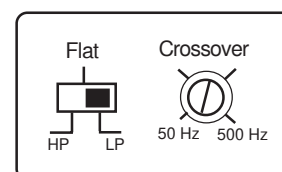



Crossovers/filters and other features on each model

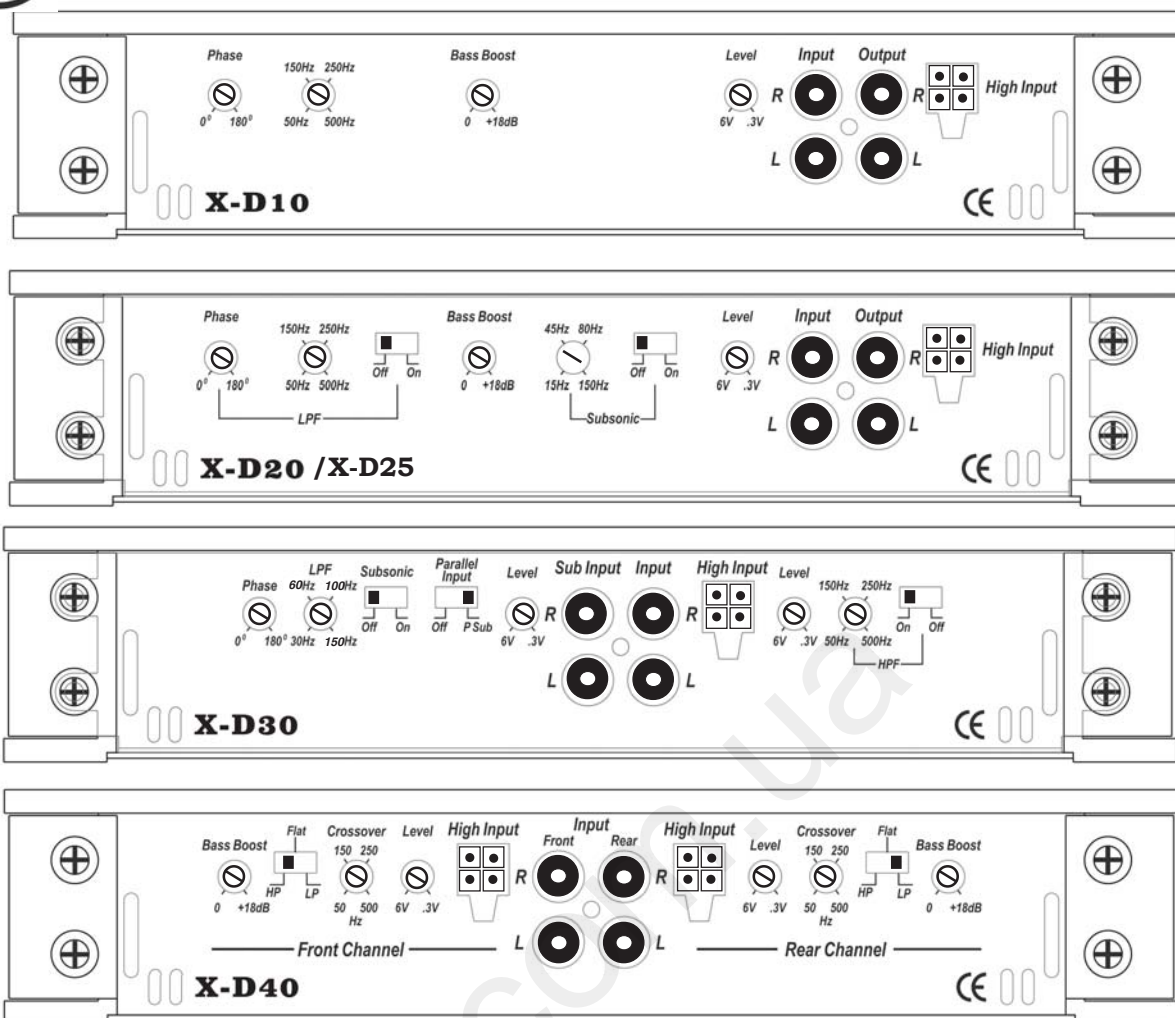

The **X-D10** is a mono channel amplifier mainly intended for use with one or more subwoofers.

The amplifier has the following filters / features:

- Lowpass filter adjustable between 50 and 500 Hz.
- Subsonic / highpass filter fixed to 25 Hz.
- Phase control adjustable 0 to 180 degrees.
- Bass boost adjustable 0 - +18 dB

The **X-D30** is a 3-channel amplifier for use with a front system and a subwoofer.

The amplifier has the following filters / features:

Stereo section:

- High pass filter adjustable from 50 to 500 Hz, the filter can be switched on - off.

Mono section:

- Lowpass filter adjustable between 30 and 150 Hz.
- Subsonic / highpass filter fixed to 25 Hz. Can be switched on - off.
- Built in subsonic 25 Hz / 18 dB for front channels
- Phase control adjustable from 0 to 180 degrees.

The **XD20 & XD25** are 2-channel amplifiers. They have the same filter configuration, only different output power.

The amplifiers have the following filters / features:

- Lowpass filter adjustable from 50 to 500 Hz.
- Subsonic / highpass filter adjustable between 15 Hz to 150 Hz. Both filters can be switched on-off.
- Phase control adjustable from 0 to 180 degrees.
- Bass boost adjustable 0 - +18 dB

The **X-D40** is a 4-channel amplifier where the filter configuration is the same for both front and rear channel pairs.

The amplifier has the following filters / features:

- Lowpass filter adjustable from 50 to 500 Hz.
- Highpass filter adjustable between 50 to 500 Hz. The filters can be turned off for running the amplifier flat.
- Built in subsonic 25 Hz / 18 dB for all channels
- Bass boost adjustable 0 - +18 dB

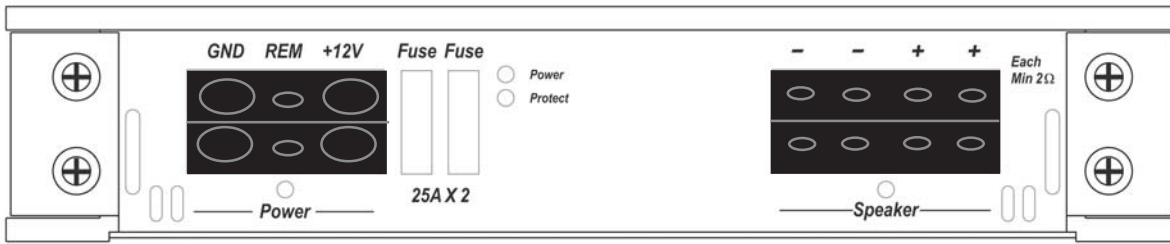

Speaker wiring X-D10

One 4 ohm subwoofer

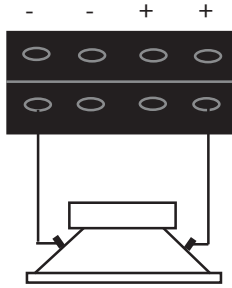

NOTE!
The speaker terminal has dual + and - for easier connection if you have more than one subwoofer. They are internally connected in parallel and can not be bridged.

NOTE!
Minimum amplifier load is 1 ohm, this connection gives a 4 ohm load with a 4 ohm subwoofer.

On page 12 you can find more examples of how to connect subwoofers to amplifiers.

Two 4 ohm subwoofers

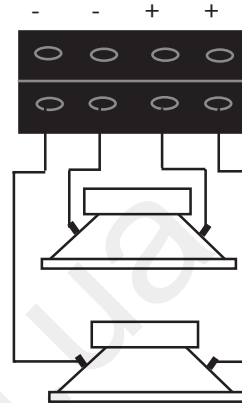

NOTE!
Minimum amplifier load is 1 ohm, lower impedances may damage the amplifier. This connection gives a 2 ohm load with 4 ohm subwoofers.

Filter settings

LP-filter:

The low pass filter is mostly used for subwoofers. It will allow low frequencies only and blocks higher frequencies. A typical setting is 50 – 70 Hz.

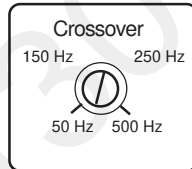

Phase control setting:

The phase control can be set continuously from 0 - 180 degrees. This function is used together with subwoofers. This is very useful when you want to adjust the bass sound for best front stage image.

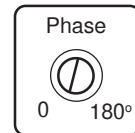

Start at 0 and turn the control slowly clockwise until you experience that the bass sound is coming from the front. If you don't get the result you want, also try to phase reverse the subwoofer connections and make a new adjustment.

Bass boost setting:

Bass boost is used to increase the bass volume at a low frequency. frequencies. You can select the amplification between 0 dB (no amplification) and +18 dB (full amplification).

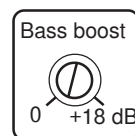

This function is used to compensate for the bass box function and to adjust for your own taste of bass. Set level control at 0 dB if you want it to be inoperative.

NOTE! Use the bass boost very carefully. The sound can be destroyed if you turn it up to high.

For power wiring, see page 4
For High or low level input wiring, see page 5

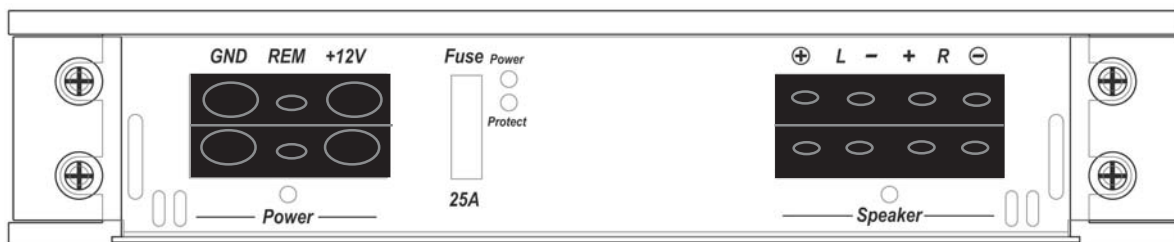

Speaker wiring X-D20 / D25

Two fullrange speakers to channel L/R

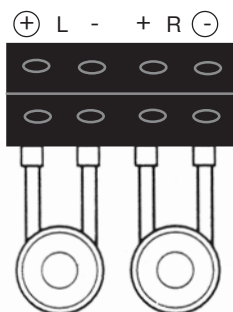

NOTE!

Minimum amplifier load is 2 ohm in stereo mode, lower impedances may damage the amplifier.

One 4 ohm subwoofer bridged

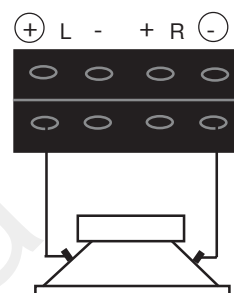

NOTE!

Minimum speaker impedance in bridged connection is 4 ohm, this connection gives a 2 ohm load with a 4 ohm subwoofer. The load is halved when connected in bridge mode.

On page 12 you can find more examples of how to connect subwoofers to amplifiers.

Filter settings

LP-filter setting:

The low pass filter is mostly used for subwoofers. It will allow low frequencies only and blocks higher frequencies.

A typical setting is 50 – 70 Hz.

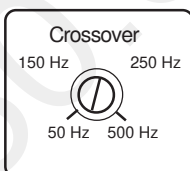

Subsonic filter setting:

This filter blocks the very deepest frequencies from reaching the subwoofers. It can be set from 15 to 150 Hz and can be switched on / off.

A typical setting for subwoofer use is 25-30 Hz.

It can also be used for a front system to limit the frequency range. The filter can stop the lowest frequencies from reaching the system when you combine with a subwoofer. A typical setting can be 60-80 Hz.

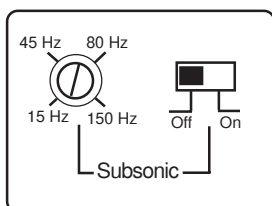

Phase control setting:

The phase control can be set continuously from 0 - 180 degrees.

This function is used together with subwoofers. This is very useful when you want to adjust the bass sound for best front stage image.

Start at 0 and turn the control slowly clockwise until you experience that the bass sound is coming from the front. If you don't get the result you want, also try to phase reverse the subwoofer connections and make a new adjustment.

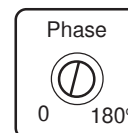

Bass boost setting:

Bass boost is used to increase the bass volume at a low frequency. frequencies. You can select the amplification between 0 dB (no amplification) and +18 dB (full amplification).

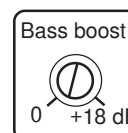

This function is used to compensate for the bass box function and to adjust for your own taste of bass. Set level control at 0 dB if you want it to be inoperative.

NOTE! Use the bass boost very carefully. The sound can be destroyed if you turn it up to high.

For power wiring, see page 4
For High or low level input wiring, see page 5

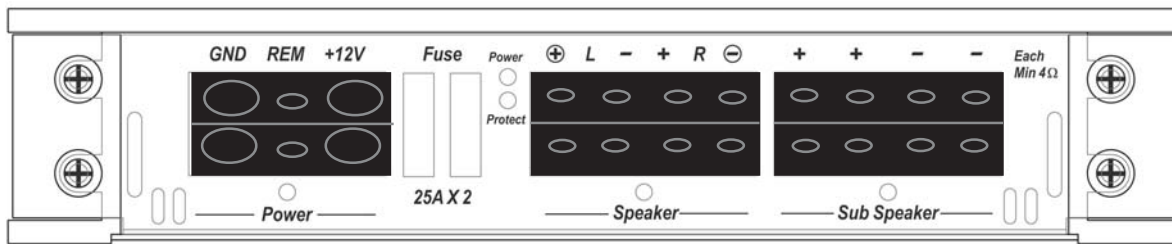

Speaker wiring X-D30

1. Two fullrange speakers to the front channels

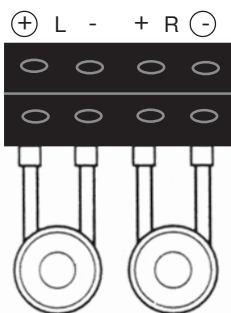

Filter settings Front channels

With the HPF-filter in OFF position the amplifier allows the speakers to play fullrange. If you for some reason want to limit the low bass reproduction switch on the HPF-filter. The typical setting is then around 60 – 80 Hz.

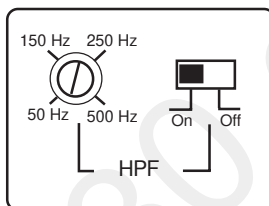

One or two subwoofers to sub channels, Each speaker min 4 ohm.

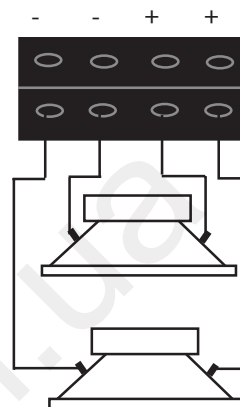

Filter settings Sub channel

The **Subsonic filter** blocks the very deepest frequencies from reaching the subwoofers. It can be switched on / off. The cutoff frequency is 25 Hz. Normal position is **ON**.

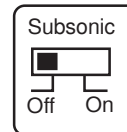

The **low pass filter** is used for subwoofers. It will allow low frequencies only and blocks higher frequencies. A typical setting is **50 – 70 Hz**.

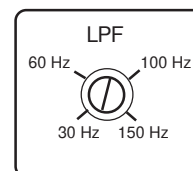

The **phase control** can be set continuously from 0 - 180 degrees. This function is used together with subwoofers. This is very useful when you want to adjust the bass sound for best front stage image. Start at 0 and turn the control slowly clockwise until you experience that the bass sound is coming from the front. If you don't get the result you want, also try to phase reverse the subwoofer connections and make a new adjustment.

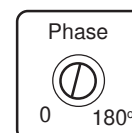

For power wiring, see page 4
For High or low level input wiring, see page 5

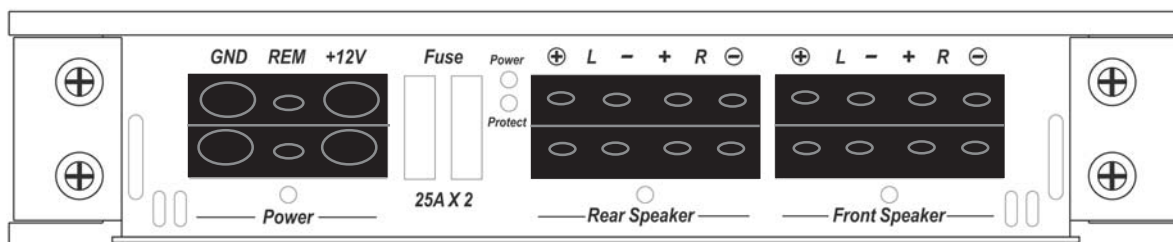

Speaker wiring X-D40

1. Four fullrange speakers to X-D40. One pair in front and one pair in rear.

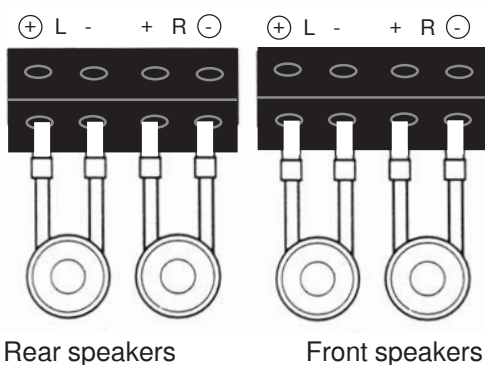

Filter settings Front channels

Filter settings Rear channels

With the filter switch in **Flat** position the amplifier allows the speakers to play fullrange. If you for some reason want to limit the low bass reproduction to the front or rear speakers, set the switch to **HP**. The typical setting is then around 60–80 Hz.

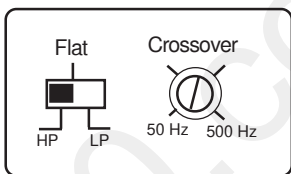

Bass boost is used to increase the bass volume at a low frequency. frequencies. You can select the amplification between 0 dB (no amplification) and +18 dB (full amplification).

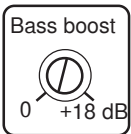

This function is used to adjust for your own taste of bass. Set level control at 0 dB if you want it to be inoperative.

NOTE! Use the bass boost very carefully. The sound can be destroyed if you turn it up to high.

For power wiring, see page 4
For High or low level input wiring, see page 5

2. Two fullrange speakers and one subwoofer bridged to X-D40.

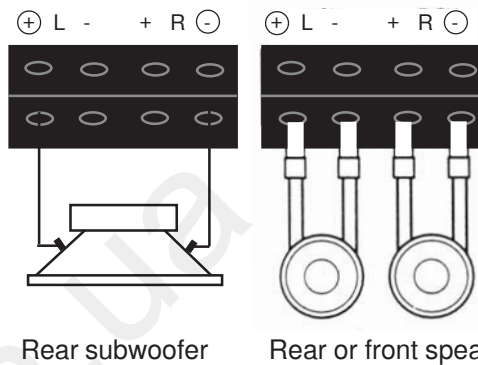

Filter settings Front channels

With the filter switch in **Flat** position the amplifier allows the speakers to play fullrange. When you have a subwoofer in your system it is advisable to limit the low bass reproduction to the front speakers, set the switch to **HP**. The typical setting is then around 60–80 Hz.

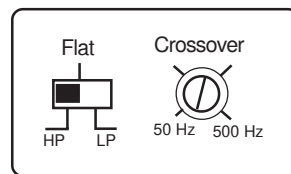

Filter settings Rear channels

Set the switch in position **LP** to activate the filter. It will allow low frequencies only and blocks higher frequencies. A typical setting is 50–70 Hz.

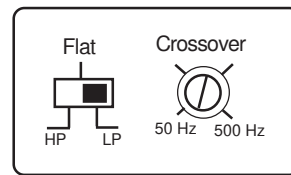

Bass boost is used to increase the bass volume at a low frequency. frequencies. You can select the amplification between 0 dB (no amplification) and +18 dB (full amplification).

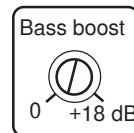

This function is used to compensate for the bass box function and to adjust for your own taste of bass. Set level control at 0 dB if you want it to be inoperative.

CONNECTION OF SUBWOOFERS TO DLS MONO AMPS

Amplifier speaker terminal

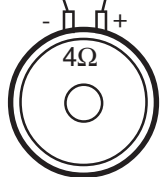
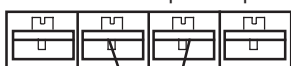

Connection of a subwoofer with 4 ohm single voice coil
Impedance = 4 ohm

Amplifier speaker terminal

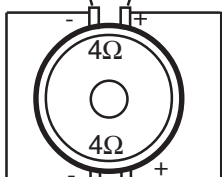

Connection of a subwoofer with 4 ohm dual voice coils
Impedance = 2 ohm

CONNECTION OF SUBWOOFERS IN BRIDGE MODE TO DLS STEREO AMPS

Amplifier speaker terminal

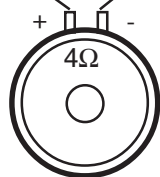
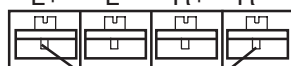

Single voice coil subwoofer connected in bridge mode.
Impedance = 4 ohm
Amplifier load = 2 ohm

Amplifier speaker terminal

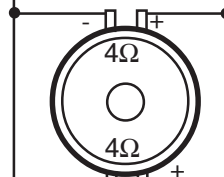

Dual voice coil subwoofer connected in parallel in bridge mode.
Impedance = 2 ohm
Amplifier load = 1 ohm

Amplifier speaker terminal

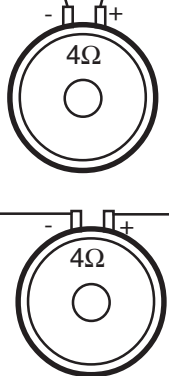

Connection of two subwoofers with 4 ohm single voice coil
Impedance = 2 ohm

Amplifier speaker terminal

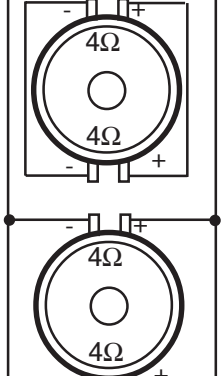

Connection of two subwoofers with 4 ohm dual voice coils
Impedance = 1 ohm

Amplifier speaker terminal

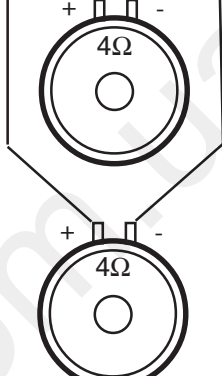
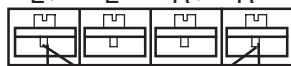

Single voice coil subwoofer connected in bridge mode.
Impedance = 2 ohm
Amplifier load = 1 ohm (only for DLS A-series amplifiers)

Amplifier speaker terminal

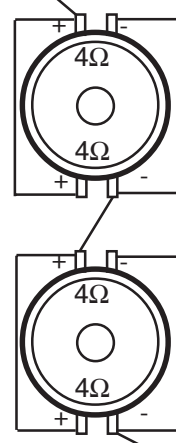
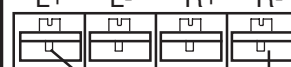

Connection of two subwoofers with 4 ohm dual voice coils in parallel and then in series to the amplifier gives a resulting impedance of 4 ohm.
Amplifier load = 2 ohm

Amplifier speaker terminal

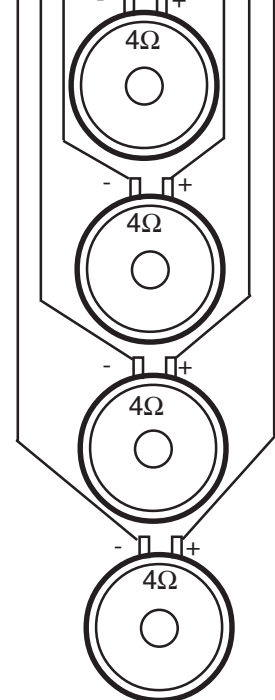

Connection of four subwoofers with 4 ohm single voice coil
Impedance = 1 ohm

Amplifier speaker terminal

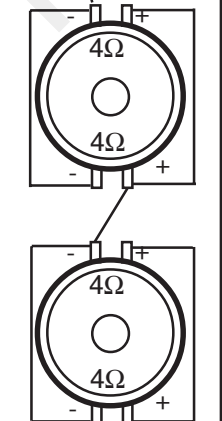

Connection of two subwoofers with 4 ohm dual voice coils in parallel and then in series to the amplifier with a resulting impedance of 4 ohms.

If you connect two subwoofers with 2 ohm voice coils in this way the resulting impedance is 2 ohms.

Amplifier speaker terminal

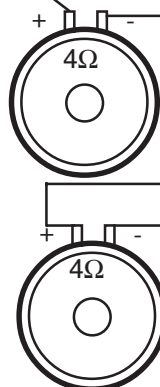
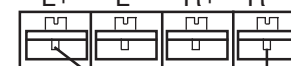

Connection of two subwoofers with 4 ohm voice coils in series
Impedance = 8 ohm
Amplifier load = 4 ohm

Amplifier speaker terminal

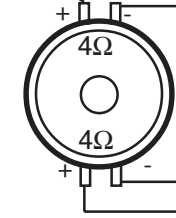
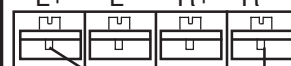

Connection of a 4 ohm dual voice coil subwoofer with the voice coils in series.
Impedance = 8 ohm
Amplifier load = 4 ohm

On DLS mono amplifiers, with dual speaker connectors, both the + and - terminals are internally connected in parallel.



Testing

Before you finish the installation, you should do the following tests to make sure the wiring is correct and everything is operating properly.

Reconnect Battery

When wiring is complete, reconnect the battery negative terminal.

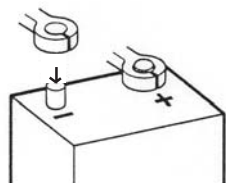

Test power wiring

1. Turn on the head unit but do not turn up the volume. The amplifier power light should come on. If not, check the remote and +12 volt wires. Also check the ground connection.
2. Turn up the head units volume slightly. All speakers should operate. If not, check wiring connections at amplifier and speakers.

Test speaker connections

Make sure the speakers are connected right. Use the balance control on the head unit to make sure right channel is on right speaker etc. If speakers don't play at all, one or both speaker wires may be disconnected.

Troubleshooting

If problems occur during the installation, or later, this guide might help you to find out what's wrong.

THE AMPLIFIER IS DEAD:

1. Check power lead, ground and remote connections at the amplifier using a multi meter.
2. Check the battery terminal connections.
3. Check the power lead fuse or circuit breaker. If fuse damage continues, inspect the power lead for short circuits.
4. Check the amplifier protection fuses. Are these broken change to new ones with the same value. If short circuiting continues, contact your local DLS dealer. A fault may exist in the amplifier.
5. To start the amplifier requires a remote voltage of 9-15 volt. Check the voltage with a multi meter.

AMPLIFIER PROTECTION FUSE BLOWS AT LOW VOLUME :

1. One or more speaker cables are shorted. Make an insulation test with a multi meter. The cables must not have a connection to earth.

THE AMPLIFIER TURNS OFF AFTER 10 - 30 MINUTES.

The amplifier is overheating due to inadequate ventilation. Check mounting position is free from obstruction.

Do this:

1. Move the amplifier to a place with better ventilation.
2. Install one or two fans to cool down the heat-sink.
3. Overheating can also be caused by an impedance load below the level permitted.

NO OUTPUT FROM ONE OR MORE SPEAKERS:

Check the following:

1. Balance control position.
2. Fader control position.
3. Speaker cable connections to both amplifier and drivers.
4. Signal lead plugs and cables.
5. Change left and right signal lead plugs in the amplifier to see if the problem moves to a different speaker, the lead has a fault. If the problem remains, the speaker or amplifier are at fault.



Professional Tip:

NOISE PROBLEMS

WHINING NOISE VARYING WITH ENGINE REVOLUTIONS:

Do this:

1. Rewire the power supply (12 V) to source unit direct from battery.
2. Rewire ground wire from source unit to clean position on chassis.
3. Check all power connections to ensure that they are clean and tight.
4. Check quality of system ground connection.
5. Install a Power Cap capacitor. This can be helpful against most noise problems.

CONSTANT WHINING NOISE:

Do this:

1. Ensure that all equipment has a common ground point.
2. Check quality of earth strap connection from battery negative terminal to chassis.
3. Disconnect signal cables from amplifier to see if noise disappears. If so the leads are picking up noise. Test this by laying a new cable over the seats and reconnecting to the amplifier. If the noise does not return, re-route original cable away from source of interference.

If noise remains regardless of cable position, try to use so called Quasi-balanced signal cables. DLS PRO-cables are Quasibalanced.

Professional Tip:

Installing in trunk

When installing the amplifier in the trunk, run the power wires along the same path as the other vehicle wiring. Many cars have insulated channels for wiring. you will have to remove the door sill trim and the carpet.

Professional Tip:

Crimp connections

Purchase crimp connectors and crimping tool. Connectors are color coded.

1. Strip 1/4 inch (6 mm) of insulation from the wire.
2. Insert into connector
3. Crimp tightly

Professional Tip:

SPEAKER POLARITY CHECK.

All speakers in a car audio system should be connected in phase (the same polarity). All speaker cones must move in the same direction. Out of phase speakers will cause a lack of bass, and a poor stereo soundstage.

Checking polarity:

Hold the - connection of the speaker wire to the - terminal of a 1,5 Volt flashlight battery. Tap the + wire on to the + terminal of the battery, and observe the movement of the cone. The cone should move outwards when the wire touches the battery, and inwards when the battery is removed. If it is the other way around, the speaker has been connected backwards and it must be removed and connected correctly.

If your system also has a subwoofer connected through a passive 6 or 12 dB crossover, try to connect this with various polarity and judge what sounds best. The phase shift in passive crossovers sometimes makes it necessary to change polarity.

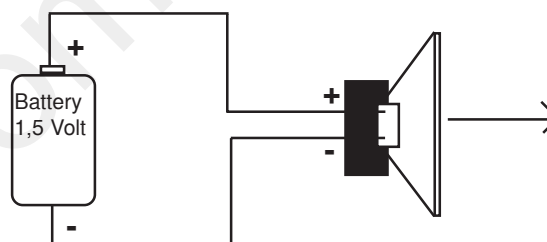

NOTE! Tweeters can not be tested this way, double check the connections instead.

Professional Tip:

Securing wires

Use wire ties to bundle together when possible. (But never bundle speaker wires or signal cables together with power wires.)



Professional Tip:

Speaker and power wires

Do not run speaker and power wires next to each other. Power wires can generate a "siren" sound in the speakers. Run speaker and power wires on opposite sides of the car.



Specifications

X-program	X-D10	X-D20	X-D25
Number of channels	1	2	2
Power output, 4 ohm (0,1% THD)	180 W	2 x 120 W	2 x 180 W
Power output, 2 ohm (0,2% THD)	330 W	2 x 200 W	2 x 280 W
Power output 1 ohm	590 W		
Power output, 4 ohm bridged	N/A	1 x 400 W	1 x 550 W
Signal to noise ratio, A-weighted	>95 dB	>100 dB	>100 dB
Damping factor	>100	>100	>100
Frequency response	15 Hz - 350 Hz	10 Hz - 35 kHz	10 Hz - 35 kHz
Input impedance, low level	33 kohm	33 kohm	33 kohm
Input impedance, high level	1 kohm	1 kohm	1 kohm
High level input with auto start	Yes	Yes	Yes
Line output (RCA)	Yes	Yes	Yes
Input sensitivity	0,3 - 6V	0,3 - 6V	0,3 - 6V
Bass boost adjustable gain	0 - 18 dB	0 - 18 dB	0 - 18 dB
Filter high pass /subsonic	built-in	15-150 Hz*	15-150 Hz*
Filter low pass	50-500 Hz	50-500 Hz*	50-500 Hz*
* can be switched in/out			
Phase control 0-180° cont.	Yes	Yes	Yes
Power consumption, idle	1,2 A	0,9 A	1,6 A
Fuse	2 x 25 A	1 x 25 A	2 x 25 A
Dimensions HxWxD(mm)	50x298x250	50x258x250	50x298x250
Dimensions (inch)	2x11,8x10	2x10,1x10	2x11,8x10
Weight	3,2 kg	2,8 kg	3,5 kg

All above output power ratings at 14,4 VDC

X-program	X-D30	X-D40
Number of channels	3	4
Power output, 4 ohm (0,1% THD)	2 x 120 W	4 x 110 W
Power output, 2 ohm (0,2% THD)	2 x 200 W	4 x 180 W
Power output, 4 ohm bridged	1 x 310 W	2 x 380 W
Power out mono sub ch. 4 ohm	1 x 220 W	N/A
Power out mono sub ch. 2 ohm	1 x 330 W	N/A
Signal to noise ratio, A-weighted	>100 dB	>100 dB
Damping factor	>100	>100
Frequency response	10 Hz - 35 kHz	10 Hz - 35 kHz
Input impedance, low level	33 kohm	33 kohm
Input impedance, high level	1 kohm	1 kohm
High level input with auto start	Yes	Yes
Line output (RCA)	No	No
Input sensitivity	0,3 - 6V	0,3 - 6V
Variable phase shift control	0-180 degrees	-
Filter high pass all channels	-	50 - 500 Hz*
Filter low pass, all channels	-	50 - 500 Hz*
Filter high pass front channels	50 - 500 Hz	-
Filter low pass, sub channel	30 - 150 Hz	-
Subsonic filter stereo channels	Fixed 25 Hz / 18 dB	Fixed 25 Hz / 18 dB
Subsonic filter mono channel	Fixed 25 Hz*	-
* can be switched in/out		
Bass boost adjustable gain	-	0 - 18 dB
Power consumption, idle	1,8 A	1,6 A
Fuse	2 x 25 A	2 x 25 A
Dimensions HxWxD(mm)	50x338x250	50x318x250
Dimensions (inch)	2x13,3x10	2x12,5x10
Weight	4,1 kg	3,8 kg

We follow a policy of continuous advancement in development.

For this reason all or part of specifications & designs may be changed without prior notice.

130.com.ua

DLS Svenska AB
P.O. Box 13029
SE-40251 Göteborg, Sweden
Tel: +46 31 840060
Fax: +46 31 844021
E-mail: info@dls.se
www.dls.se