



PHONES

0 (800) 800 130
(050) 462 0 130
(063) 462 0 130
(067) 462 0 130

130
COM.UA

Internet store of
autogoods



SKYPE

km-130

CAR RECEIVERS — Receivers • Media receivers and stations • Native receivers • CD/DVD changers • FM-modulators/USB adapters • Flash memory • Facia plates and adapters • Antennas • Accessories |
CAR AUDIO — Car audio speakers • Amplifiers • Subwoofers • Processors • Crossovers • Headphones • Accessories | TRIP COMPUTERS — Universal computers • Model computers • Accessories |
GPS NAVIGATORS — Portable GPS • Built-in GPS • GPS modules • GPS trackers • Antennas for GPS navigators • Accessories | VIDEO — DVR • TV sets and monitors • Car TV tuners • Cameras • Videomodules
• Transcoders • Car TV antennas • Accessories | SECURITY SYSTEMS — Car alarms • Bike alarms • Mechanical blockers • Immobilizers • Sensors • Accessories | OPTIC AND LIGHT — Xenon • Bixenon • Lamps
• LED • Stroboscopes • Optic and Headlights • Washers • Light, rain sensors • Accessories | PARKTRONICS AND MIRRORS — Rear parktronic • Front parktronic • Combined parktronic • Rear-view mirrors
• Accessories | HEATING AND COOLING — Seat heaters • Mirrors heaters • Screen-wipers heaters • Engine heaters • Auto-refrigerators • Air conditioning units • Accessories | TUNING — Vibro-isolation
• Noise-isolation • Tint films • Accessories | ACCESSORIES — Radar-detectors • Handsfree, Bluetooth • Windowlifters • Compressors • Beeps, loudspeakers • Measuring instruments • Cleaners • Car seats
• Miscellaneous | MOUNTING — Installation kits • Upholstery • Grilles • Tubes • Cable and wire • Tools • Miscellaneous | POWER — Batteries • Converters • Start-charging equipment • Capacitors
• Accessories | MARINE AUDIO AND ELECTRONICS — Marine receivers • Marine audio speakers • Marine subwoofers • Marine amplifiers • Accessories | CAR CARE PRODUCTS — Additives • Washer fluid •
Care accessories • Car polish • Flavors • Adhesives and sealants | LIQUID AND OIL — Motor oil • Transmission oil • Brake fluid • Antifreeze • Technical lubricant



In store "130" you can find and buy almost all necessary goods for your auto in Kyiv and other cities, delivery by ground and postal services. Our experienced consultants will provide you with exhaustive information and help you to choose the very particular thing. We are waiting for you at the address

<https://130.com.ua>



How to install and operate the
Reference RM-series amplifiers

RM10 - RM15 RM20 - RM30 RM40

Welcome!

This owners manual is written in easy english and uses a lot of drawings to simply the installation and use of the above amplifiers.

Your Reference series amplifiers must be installed correctly in order to work well. This manual will show you how to install the amplifier like a pro. Please read the entire manual before beginning the installation. Install the amplifier yourself if you feel confident with our instructions and if you have the proper tools. However if you feel unsure, turn over the installation job to someone better suited to it.

Warranty Service

This amplifier is covered by warranty, depending on the conditions in the country where it is sold. If the amplifier is returned for service, please include the original dated receipt with the product.



Technical Assistance

For technical assistance ask the shop where the product was sold or the distributor in your very country. Information can also be found on our WEB-site www.dls.se

We follow a policy of continuous advancement in development. For this reason all or part of specifications & designs may be changed without prior notice.

DECLARATION OF CONFORMITY

DLS amplifiers for vehicles are manufactured in accordance with the EU directive EEC 95/54 (72/245/EEC) and are marked with the approval number. They are also marked in accordance with the WEEE-directive 2002/96/EC. The products are also produced in accordance with the EU RoHS directive 2002/95/EC.

Contents

Features.....	2
Installation.....	2
Tools and materials needed.....	3
Amplifier installation kit.....	3
Routing Wires.....	3

Wiring

Power and Outputs.....	4
Inputs and controls.....	5
High and low level inputs.....	5
Input level control.....	6
Crossovers, etc.....	6
Features on each model.....	7

RM10 speaker wiring:

Subwoofer.....	8
----------------	---

RM15 speaker wiring:

Subwoofer.....	9
----------------	---

RM20 speaker wiring:

Front speakers.....	10
Subwoofer.....	10

RM30 speaker wiring:

Two speakers and one subwoofer....	11
------------------------------------	----

RM40 speaker wiring:

Four speakers.....	12
Two speakers + bridged subwoofer	12

Testing.....	13
Troubleshooting.....	13
Professional tips.....	14
Specifications.....	15



This product must be returned to the separate collection system for electronic products. Do not dispose this product together with general household waste.

DLS Svenska AB

P.O. Box 13029 - SE-40251 Göteborg - Sweden
Tel: +46 31 840060 - Fax: +46 31 844021
E-mail: info@dls.se
www.dls.se



Features:

- ◆ RCA inputs
- ◆ High level inputs
- ◆ Continuously variable high pass and/or low pass crossovers
- ◆ Bass EQ / SUB EQ function (only RM10, RM15 & RM20)
- ◆ Remote start
- ◆ Automatic remote start on high level inputs without the use of remote wire
- ◆ Electronic protection circuits against short circuit, DC offset and high temperature
- ◆ Bridge mode capability on the stereo amplifiers

We follow a policy of continuous advancement in development. For this reason all or part of specifications & designs may be changed without prior notice.

Installation

Before you begin installation

Before you begin you need to read the manual, to have some tools, cables and other material available. There is one such list of material on the following page.

Amplifier location

Important

Allow air circulation around the amplifier.

The Reference series of amplifiers have a compact design that allows great flexibility in mounting. You can mount it under a seat or in the trunk. When you select a location, do remember that the amplifier generates a lot of heat.

Choose a location where air can circulate freely around the amplifier. Do not cover the amplifier with carpets or hide behind trim panels. Do not mount the amplifier in an inverted or upside down position.

Check all locations and placements carefully before making any cuts, drilling any holes or making any connections.

Disconnect Battery

Before starting the installation, always disconnect the negative terminal of the battery.

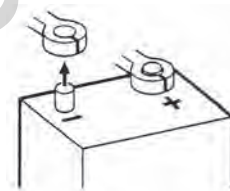

DLS logo on amplifier cooling flange

The DLS logo on the amplifier top is attached with two small screws. The logo can be removed and twisted 90 or 180 degrees, and then screwed back in wanted position. The logo can be mounted in four different ways to match your installation.

Mounting

IMPORTANT!

Use the metal screws coming with the amplifier when you do the install. Do not use oversized screws, you may destroy the plastic ears by doing so.

The RM15, RM30 and RM40 has a cooling fan built-in, make sure that the air can circulate freely around the fan opening.



Tools and material needed

Tools:

- ◆ Flat and Phillips screwdrivers
- ◆ Wire cutter
- ◆ Wire stripper
- ◆ Electric drill with drills
- ◆ Crimping tool
- ◆ Digital multimeter or test lamp
- ◆ Wire brush, scraper or a piece of an abrasive sheet to remove paint for a good ground connection
- ◆ Grease to protect the ground connection from oxidation

Material:

- ◆ Speaker wire: minimum
12 AWG = 4 mm² for subwoofers
13 – 16 AWG = 1,5-2,5 mm² for other speakers
- ◆ Sheet metal screws for mounting the amplifier to the amplifier board and the amplifier board to the car + some extra for fuse holder, amplifier ground etc.
- ◆ Electrical insulation tape
- ◆ ½ inch thick plywood or particle board for the amplifier to be mounted upon.

Amplifier installation kit:

If available, buy an amplifier installation kit. It contains normally all you need. This is what you have to buy if you buy the items separately

- ◆ 20- 25 feet = 6- 7.5 meter power cable, min AWG 5 = 16 mm² or heavier.
- ◆ 20 feet of AWG 15 = 1,5 mm² wire for remote turn on / off cable from radio.
- ◆ RCA-cable for input from radio.
- 20 feet or 5 meter for trunk installations
- 12 feet or 2 – 3 meter for under seat installations
- ◆ Four to eight splicers to connect speaker cables to high level input cable, if high level input is used.
- ◆ Wire ties
- ◆ Insulating grommet or insulating tube

Routing wires

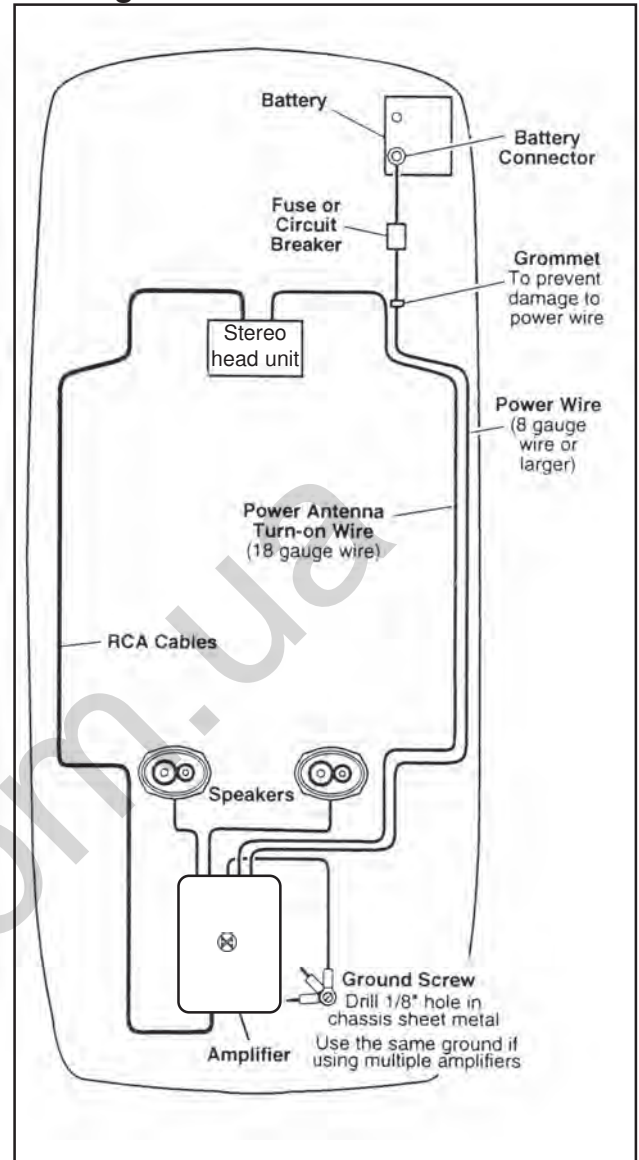

Professional Tip:

If amplifier installation kits are available with different size of power cable, chose the most heavy power cable to improve sound quality and to allow more amplifiers to be installed now or later. The amplifier power terminals accept AWG 4 cables directly, so If possible buy AWG 4 = 21 mm² cable for best performance (RM20 only AWG5, 16 mm²).

Both the positive wire and the ground wire must have the same size. To avoid cable fire, be sure not to oversize the main fuse value for the power wires.

THE DC-FEED

Maximum main fuse values for different cable sizes.

6 mm ² (9 AWG)	:25 A	10 mm ² (7AWG)	:40 A
16 mm ² (5AWG)	:60 A	21 mm ² (4AWG)	:100 A
33 mm ² (2AWG)	:150 A	42 mm ² (1AWG)	:200 A



Wiring

Power and Outputs

Power terminal (+12V)

Connect the fuse holder as close to the vehicle battery + as possible, using AWG 4 = 21 mm² power cable. Use a ring crimp terminal cable to connect to battery +. Apply silicon grease to the fuse to prevent corrosion. The AWG4 cable can use an 80 Amp fuse, if the cable is smaller, the fuse value must be lower (see table on previous page).

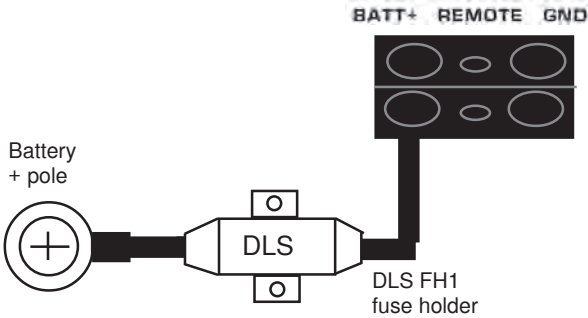

A cable up to AWG 4 fits directly in the amplifier + 12 V terminal, tighten with the hex screw. RM20 handles AWG5 (16 mm².) Be sure to use a rubber grommet or a plastic insulating tube where the cable passes the firewall or other places where it can be easily jammed. Use wire ties to secure to existing cables in the engine compartment.

Ground Terminal (GND)

Connect to a good chassis ground. The ground connection should be clean, unpainted metal to provide a good electrical connection. Use a wire brush, a scraper or a piece of an abrasive sheet to clean the metal. Use a lock washer or two to secure contact. Protect with silicon grease or by paint applied afterwards.

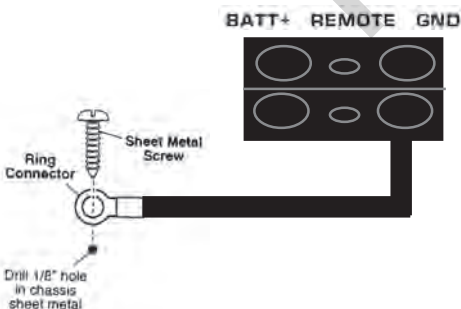

Fuses

Use only ATC blade type fuses when replacing a blown fuse. Replace with the same fuse value as original.

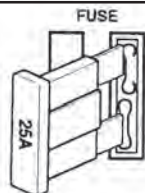

Remote terminal

For RCA cable signal input:

Connect the radio power antenna lead = remote turn on/off from the car stereo to the amplifier remote connection. This turns on the amplifier whenever the car stereo is turned on. You can either use the built in remote cable in the RCA cable itself, or use a separate cable.

Sometimes a small disturbance may enter the amplifier coming from the remote voltage, through the built in remote wire and into the RCA cable. Thus we recommend to use a separate remote wire and run the RCA lead separate from remote wire, power cables and speaker cables. You can insert the cable directly into the amplifier terminal. If there is no remote voltage available from the stereo, you must connect to the ignition key through the radio or any accessories fuse.

For High Level input:

We recommend you to connect the remote wire as described above. The amplifier will produce soft on / soft off operation this way. In the case that there is no remote voltage available from the car stereo or you want to simplify the installation, the amplifier can be turned on/ turned off by the high level input voltage. This is done automatically when the head unit is turned on. There is a small disadvantage that this function gives soft turn on operation but some pop sound when switching off.

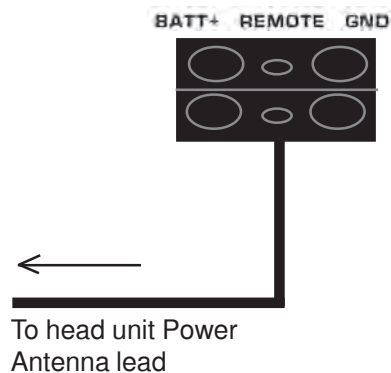

Power Light / Protect light

- Protect (Red) The power light (green) comes on when the amplifier is turned on.
- Power (Green) The protect light (red) comes on when the amplifier shuts down from overheating, or a short circuit (speaker failure)



Input and controls

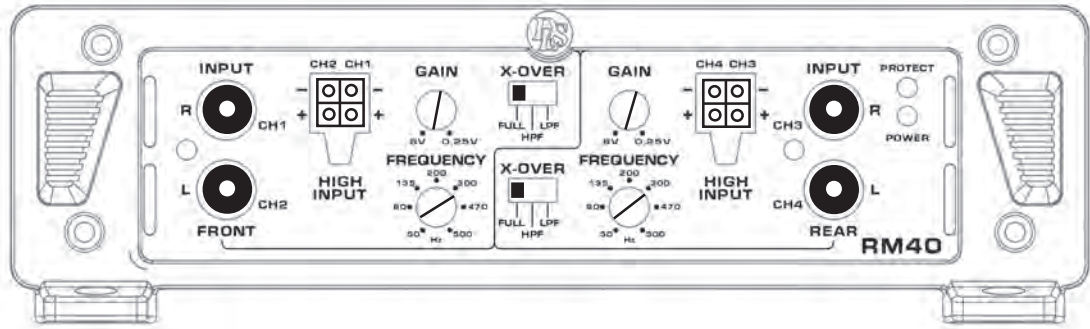

Input Wiring

Inputs may be low level from the RCA output of the car stereo or high level from the car stereo speaker output. Low level = RCA is to prefer for the best sound quality.

Important

Use either the low level or high level input, do not use both at same time.

Low level input

Use a pair of shielded stereo audio cables with RCA type jack. Most trunk-mount amplifiers need a 20 feet RCA cable (appr 5 – 6 meters). Most under the seat installations require 12 feet (2 – 3 meters) RCA cables. Avoid placing the RCA cable close to speaker cables, power cables and remote control cable. Connect to input socket R/L.

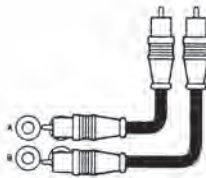

RM40 has dual inputs, Front R/L (CH1/2) & Rear R/L (CH3/4). Depending on your chosen configuration you can use either two separate RCA cables, or a single RCA cable together with an Y-split to connect both inputs.

RM30 has dual inputs, one for the stereo channels (Input R/L, CH1, CH2), and one for the mono channel (Sub Input R/L, CH3, CH4), both inputs must be connected on the mono channel input socket.

Parallel input on RM30

If you don't have dual line cables to front and sub Input you can use a single line cable. Connect to the stereo input sockets and set the Parallel input switch to position P-sub and the signal is fed to the Sub input socket automatically.

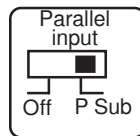

RCA-output on RM10, RM15, RM20

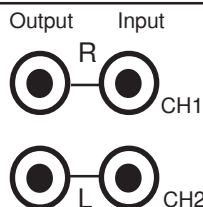

Use RCA Outputs to connect additional amplifiers (not available on RM30 / RM40).

High Level Input wiring

Connect left and right speaker wires coming from the car stereo to the high level input as shown. You must connect both plus and minus as the inputs are balanced, connecting plus only gives lower level and bad sound quality. By changing the polarity of plus and minus, you can change the phase.

RM10/15/20/30

On these models you connect as in this example:

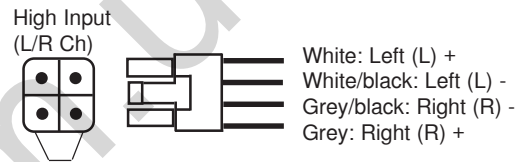

RM30

On RM30 the high level signal is fed internally to channel SUB when using high level input.

RM40

The four channel amplifier is connected likewise, however we have four channels. You can feed two channels from RCA and two channels using high level input from rear speaker cables.

High level input socket :

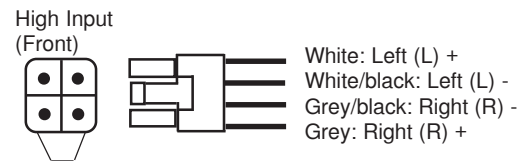

Hi level input plug on amp

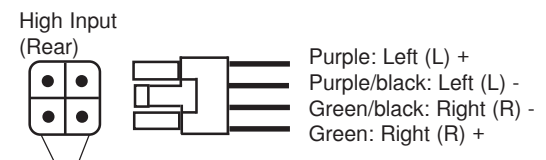

Hi level input plug on amp

Automatic turn on when using high level input.

The amplifier turns on automatically when using high level input, you dont need to connect a separate remote wire from your head unit.

For a soft turn ON /OFF operation we recommend you to use a remote wire, if this is available.



Features / crossovers

Input Level control (GAIN)

The input level control, 8V – 0,25 V, matches the output of your radio to the input of the amplifier. After installation is complete, make sure the input of the amplifier is turned down all the way (counter-clockwise at 8V).

Play a CD, make sure all bass or treble settings or equalizer are flat, and turn the volume of the radio up until you just start to hear distortion. Turn the volume control down just a bit. On the amplifier increase the input level control (clockwise or to the right) until you just start to hear distortion, then back the level control just a bit. Now your radio and amplifier levels are matched.



SUB EQ on RM10 & RM15

SUB EQ is used to increase the bass volume at a low frequency. You can select the amplification between 0 dB (no amplification) and +6 dB (full amplification) at 40 Hz center frequency

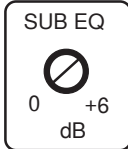

This function is used to compensate for the bass box function and to adjust for your own taste of bass. Set level control at 0 dB if you want it to be inoperative.

BASS EQ on RM20

BASS EQ is used to increase the bass volume at a low frequency. You can select the amplification between 0 dB (no amplification) and +6 dB (full amplification) at 80 Hz center frequency.

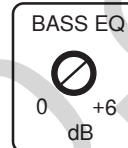

This function is used to compensate for the bass function on your front system and adjust for your own taste of bass. Set level control at 0 dB if you want it to be inoperative.

PHASE switch on RM 10, RM15, RM30

The phase can be adjusted in either 0 or 180 degrees. This is used to get the best possible "front stage" from the subwoofer.



Subsonic / high pass filter on RM15

The **Subsonic filter** blocks the very deepest frequencies from reaching the subwoofers. It can be set from 15 to 150 Hz and can be switched on / off. A typical setting for subwoofer use is 25-30 Hz

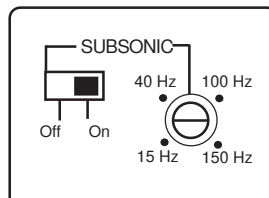

High pass filter RM20, RM30

The high pass filter blocks very low frequencies from reaching the speakers. It is mostly used at say 60 Hz to protect small speakers (like 6 inch and smaller) from deep bass. The HPF filter is used in this way if **RM20 / RM30** is used in stereo mode.

If **RM20** is used for running a subwoofer in bridge mode the filter can be used to stop the lowest frequencies from reaching the subwoofer. It can be adjusted from 15 to 500 Hz.

A typical setting for a subwoofer is 25-30 Hz.

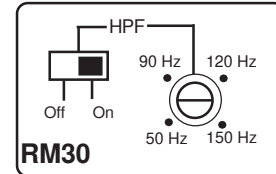
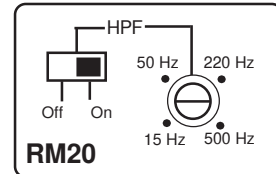

High pass filter RM40

The high pass filter blocks very low frequencies from reaching the speakers. It is mostly used at say 60 Hz to protect small speakers (like 6 inch and smaller) from deep bass.

Set the switch to position **HPF** to connect the filter, or in position **FULL** if you don't want to limit the frequency range.

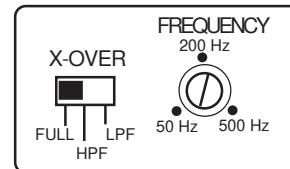

Low pass filter RM10, RM15, RM20, RM30

The low pass filter is mostly used for subwoofers. It will allow low frequencies only and blocks higher frequencies. A typical setting is 50 – 70 Hz.

On **RM10/15** you can also choose filter slope, 12 dB or 24 dB.

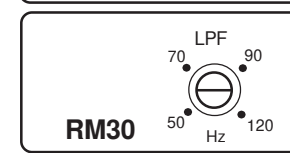
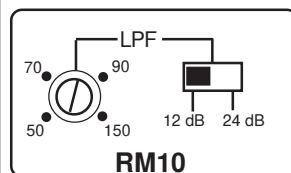
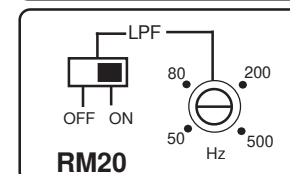
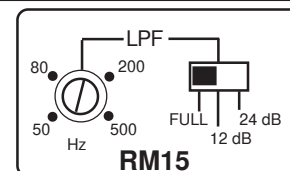

Low pass filter RM40

The low pass filter is mostly used for subwoofers. It will allow low frequencies only and blocks higher frequencies. A typical setting is 50 – 70 Hz.

Set the switch in position **LPF** to activate the filter. Set the filter switch in **FULL** position if you want to run the amplifier in full range mode.

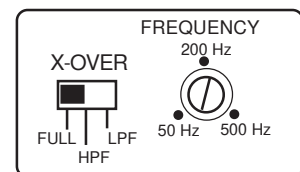

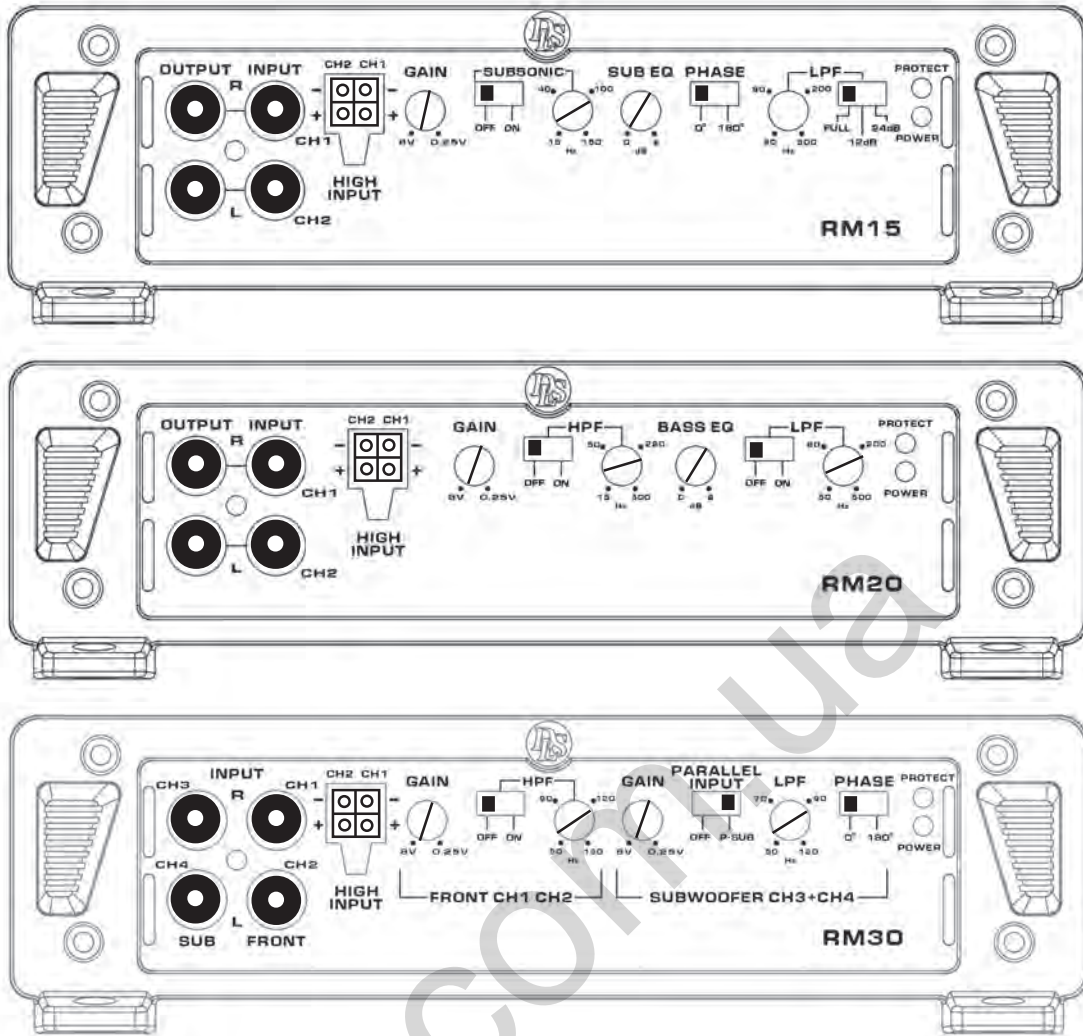

RM10 is a mono amplifier used to run one or more subwoofers.
See page 8 for detailed information.

RM15 is a mono amplifier used to run one or more subwoofers.

The amplifier has the following filters / features:

- Low pass filter variable 50 to 500 Hz
Selectable slope 12 / 24 dB
- Subsonic / high pass filter variable 15-150 Hz
- Phase switch selectable 0 or 180 degrees
- SUB EQ variable 0 - +6 dB
- Parallel Input switch
- High level input with auto start
See above drawing

RM20 is a 2-channel amplifier.

The amplifier has the following filters / features:

- Low pass filter variable 50 to 500 Hz
- Subsonic / high pass filter variable 15 Hz to 500 Hz. Both filters can be switched ON / OFF
- BASS EQ variable 0 - +6 dB
- High level input with auto start
See above drawing

RM30 is a 3-channel amplifier for use with a front system and one or more subwoofers.

The amplifier has the following filters / features:

Stereo channels:

- High pass filter variable 50 to 150 Hz, the filter can be switched ON / OFF
- High level input with auto start

Mono channel:

- Low pass filter variable 50 to 120 Hz
- Phase switch 0 or 180 degrees
See above drawing

RM40 is a 4-channel amplifier where the filter configuration is the same for all channels.

The amplifier has the following filters / features:

- Low pass filter variable 50 to 500 Hz
The filter can be switched ON / OFF
- High pass filter variable 50 to 500 Hz
The filter can be switched ON / OFF
- High level input with auto start.
See drawing on page 5

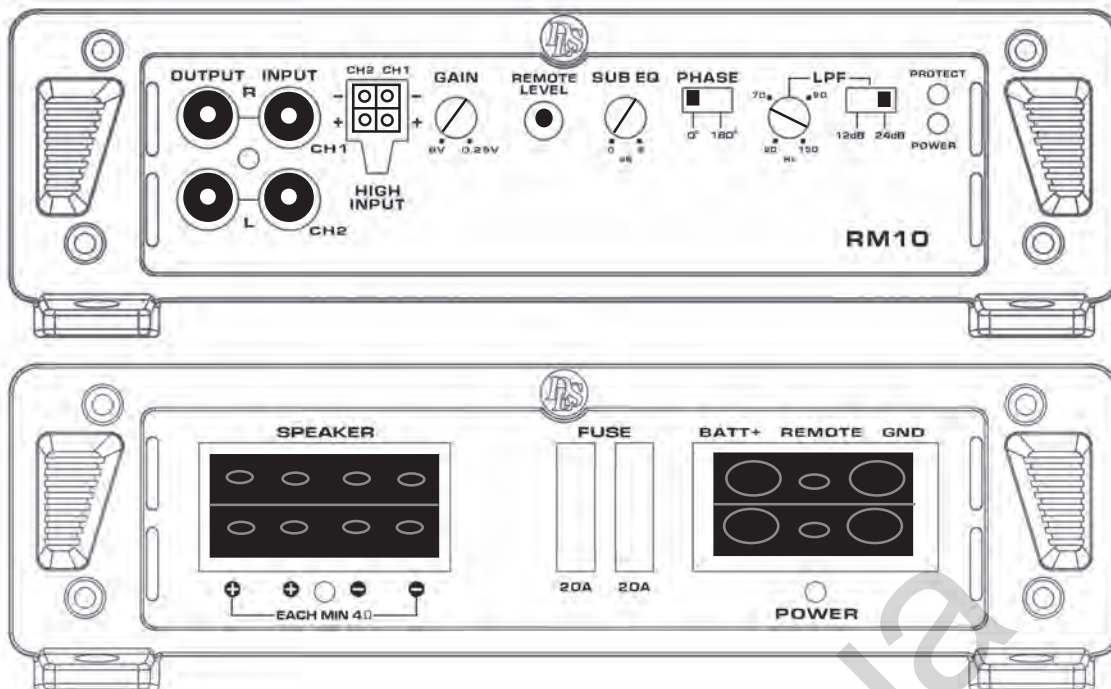

One 4 ohm or 2 ohm subwoofer

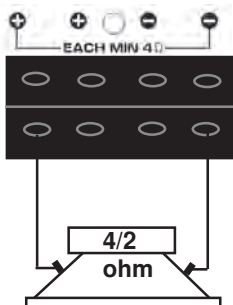

NOTE!

The speaker terminal has dual + and - for easier connection if you have more than one subwoofer. They are internally connected in parallel and **can not be bridged.**

NOTE!

Minimum amplifier load is two (2) ohm. You can connect two 4 ohm subwoofers or a single 2 ohm subwoofer to the amplifier.

Two 4 ohm subwoofers

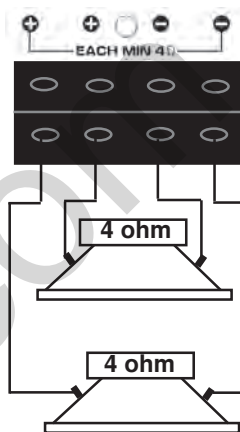

NOTE!

Minimum amplifier load is 2 ohm, lower impedances may damage the amplifier. This connection gives a 2 ohm load with 4 ohm subwoofers.

RM10 is a mono amplifier used to run one or more subwoofers.

The amplifier has the following filters / features:

- Low pass filter variable 50 to 150 Hz
Selectable slope 12 / 24 dB
- Phase switch selectable 0 or 180 degrees
- SUB EQ variable 0 - +6 dB.
- External sub level control
- High level input with auto start

Filter settings LPF low pass filter

The low pass filter is mostly used for subwoofers. It will allow low frequencies only and blocks higher frequencies. A typical setting is 50 – 70 Hz.

You can also choose filter slope, 12 dB or 24 dB. Choose the setting that sounds best in your car.

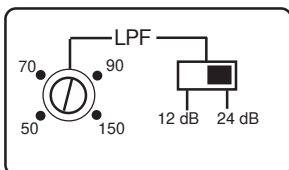

PHASE switch:

The phase can be adjusted in either 0 or 180 degrees. This is used to get the best possible "front stage" from the subwoofer.



SUB EQ is used to increase the bass volume at a low frequency. You can select the amplification between 0 dB (no amplification) and +6 dB (full amplification) at 40 Hz center frequency.

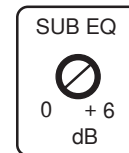

This function is used to compensate for the bass box function and to adjust for your own taste of bass. Set level control at 0 dB if you want it to be inoperative.

Remote sub level control

You can adjust the sound level from the front seat of your car if you connect the external sub level control box. Connect to **REMOTE LEVEL** socket.

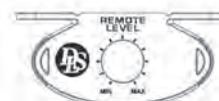

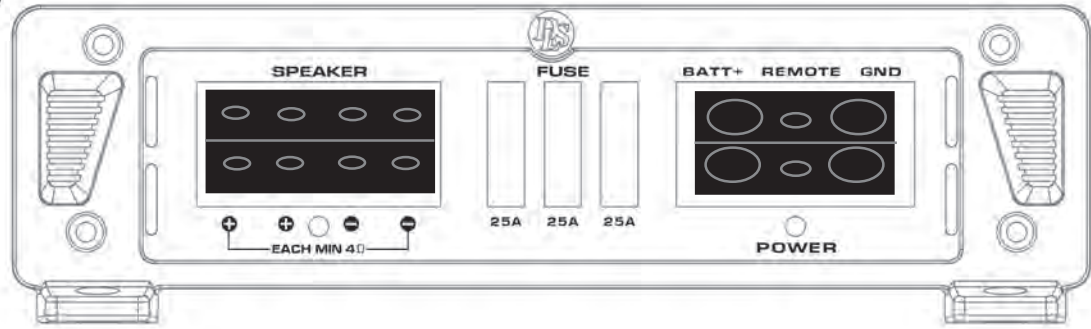

Speaker connection to RM15

One 4 ohm or 2 ohm subwoofer

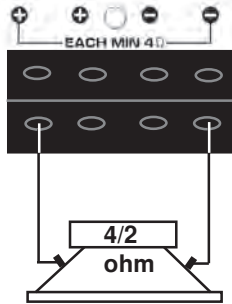

NOTE!

The speaker terminal has dual + and - for easier connection if you have more than one subwoofer. They are internally connected in parallel and **can not be bridged.**

NOTE!

Minimum amplifier load is two (2) ohm. You can connect two 4 ohm subwoofers or a single 2 ohm subwoofer to the amplifier.

Two 4 ohm subwoofers

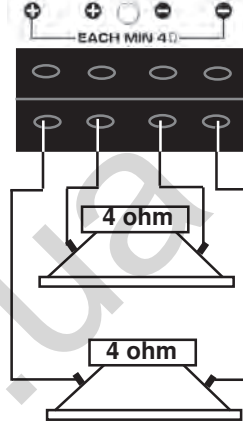

NOTE!

Minimum amplifier load is 2 ohm, lower impedances may damage the amplifier. This connection gives a 2 ohm load with two 4 ohm subwoofers.

Filter settings LPF low pass filter

The low pass filter is mostly used for subwoofers. It will allow low frequencies only and blocks higher frequencies. A typical setting is 50 – 70 Hz.

You can also choose filter slope, 12 dB or 24 dB. Choose the setting that sounds best in your car.

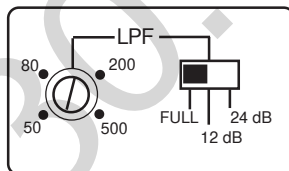

The **Subsonic filter** blocks the very deepest frequencies from reaching the subwoofers. It can be set from 15 to 150 Hz and can be switched on / off. A typical setting for subwoofer use is 25-30 Hz

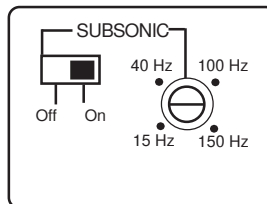

PHASE switch:

The phase can be adjusted in either 0 or 180 degrees. This is used to get the best possible "front stage" from the subwoofer.

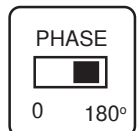

SUB EQ is used to increase the bass volume at a low frequency. You can select the amplification between 0 dB (no amplification) and +6 dB (full amplification) at 40 Hz center frequency

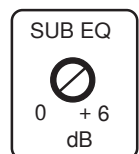

This function is used to compensate for the bass box function and to adjust for your own taste of bass. Set level control at 0 dB if you want it to be inoperative.

For power wiring, see page 4
For high or low level input wiring, see page 5

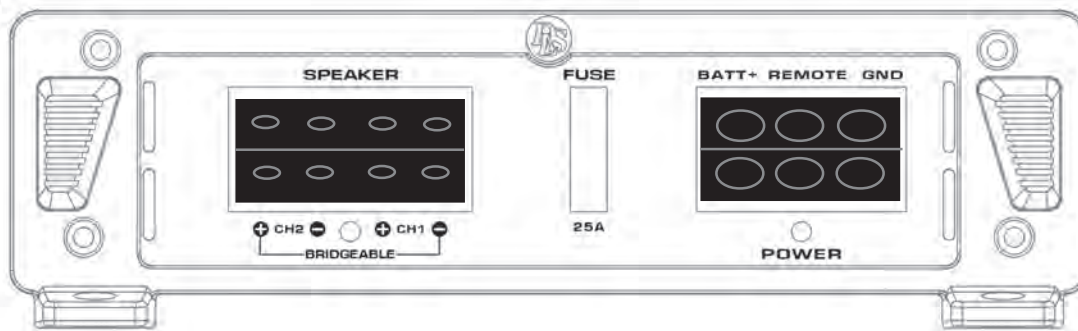

Speaker connections to RM20

Two full-range speakers, coaxial or component, connected to left & right channel.

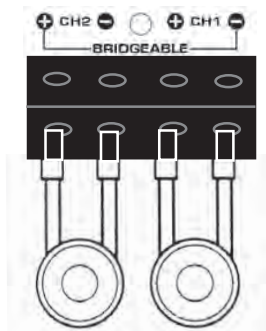

NOTE!

Minimum amplifier load in stereo is 2 ohm, lower impedances may damage the amplifier.

One 4 ohm subwoofer connected in bridge mode to the outer connections of the speaker terminal.

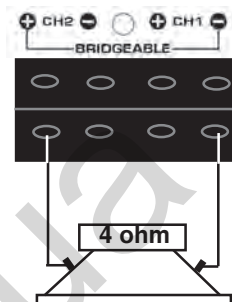

NOTE!

Minimum amplifier load in bridge mode is 4 ohm. This connection gives a 2 ohm load with a 4 ohm subwoofer (the load is halved when connected in bridge mode).

Filter setting LPF low pass filter

The low pass filter is mostly used for subwoofers. It will allow low frequencies only and blocks higher frequencies. A typical setting is 50 – 70 Hz.

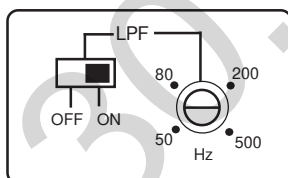

The **Subsonic filter** blocks the very deepest frequencies from reaching the subwoofers. It can be set from 15 to 150 Hz and can be switched on / off. A typical setting for subwoofer use is 25-30 Hz

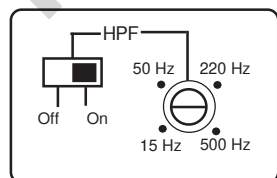

The high pass filter can also be used to block very low frequencies from reaching the speakers. It is mostly used at say 60 Hz to protect small speakers (like 6 inch and smaller) from deep bass.

BASS EQ

BASS EQ is used to increase the bass volume at a low frequency. You can select the amplification between 0 dB (no amplification) and +6 dB (full amplification) at 80 Hz center frequency.

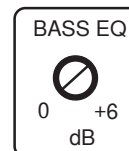

This function is used to compensate for the bass function on your front system and adjust for your own taste of bass. Set level control at 0 dB if you want it to be inoperative.

For power wiring, see page 4
For high or low level input wiring, see page 5

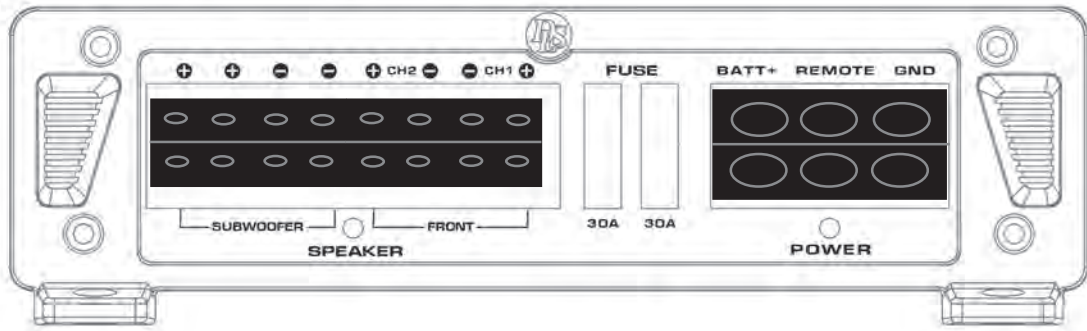

Speaker connections to RM30

One or two subwoofers to the sub mono channel (CH3 + CH4). Each speaker min 4 ohm impedance

Two full-range speakers to front channels CH1, CH2

NOTE!

The speaker terminal has dual + and - for easier connection if you have more than one subwoofer. They are internally connected in parallel and **can not be bridged**.

NOTE!

Minimum amplifier load is two (2) ohm. You can connect two 4 ohm subwoofers or a single 2 ohm subwoofer to the amplifier.

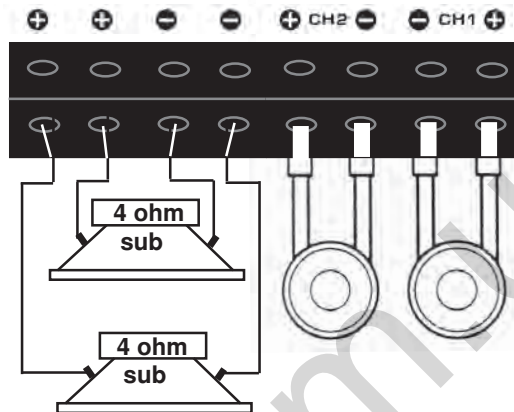

Two full-range speakers, coaxial or component, connected to left & right channel.

NOTE!

Minimum amplifier load is 2 ohm, lower impedances may damage the amplifier.

Filter settings front channels, CH1 + CH2

The high pass filter blocks very low frequencies from reaching the speakers. It is mostly used at say 60 Hz to protect small speakers (like 6 inch and smaller) from deep bass.

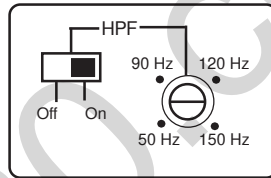

Set the switch to position **ON** to connect the filter, or in position **OFF** if you don't want to limit the frequency range.

Filter settings sub mono channel, CH3 + CH4

PHASE switch:

The phase can be adjusted in either 0 or 180 degrees. This is used to get the best possible "front stage" from the subwoofer.

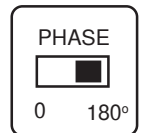

The low pass filter is mostly used for subwoofers. It will allow low frequencies only and blocks higher frequencies. A typical setting is 50 – 70 Hz.

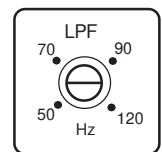

For power wiring, see page 4
For high or low level input wiring, see page 5

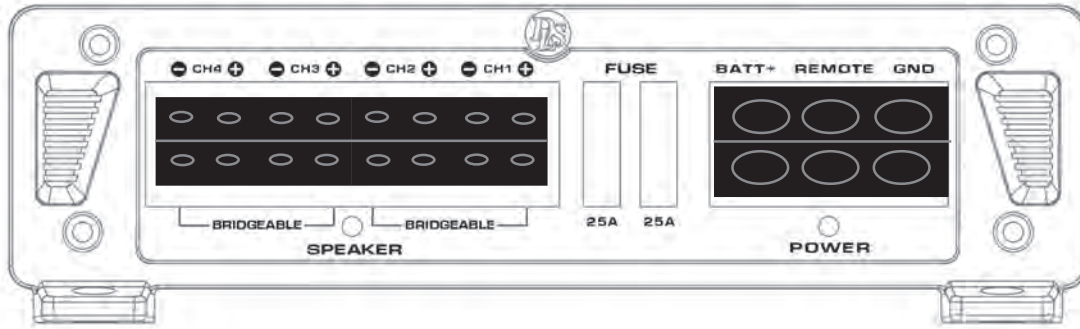

Speaker connections to RM40

1. Four full-range speakers. One front and one rear pair.

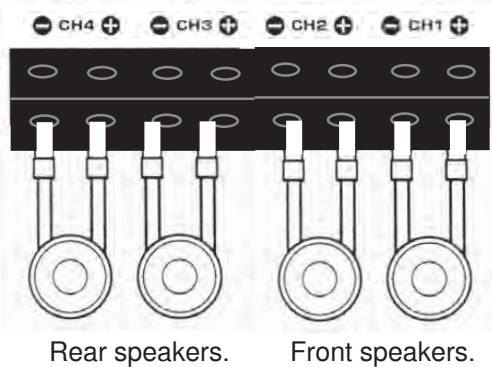

Four full-range speakers, coaxial or component, connected to all four channels.

NOTE!

Minimum amplifier load in stereo is 2 ohm, lower impedances may damage the amplifier.

Filter settings front channels, CH1 + CH2 Filter settings rear channels, CH3 + CH4

The high pass filter blocks very low frequencies from reaching the speakers. It is mostly used at say 60 Hz to protect small speakers (like 6 inch and smaller) from deep bass.

Set the switch to position **HPF** to connect the filter, or in position **FULL** if you don't want to limit the frequency range.

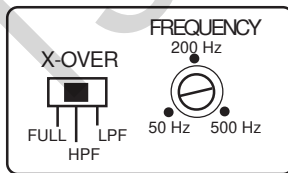

2. Two full-range speakers and a subwoofer connected in mono bridge mode.

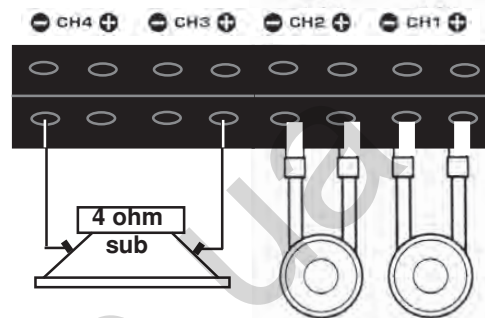

Subwoofer ♦ Front (or rear) speakers

One 4 ohm subwoofer connected in bridge mode to channel 3 & 4, plus a front speaker pair in stereo to channel 1 & 2.

NOTE!

Minimum amplifier load in bridge mode is 4 ohm. This connection gives a 2 ohm load with a 4 ohm subwoofer (the load is halved when connected in bridge mode).

Filter settings front channels, CH1 + CH2

The high pass filter blocks very low frequencies from reaching the speakers. It is mostly used at say 60 Hz to protect small speakers (like 6 inch and smaller) from deep bass.

Set the switch to position **HPF** to connect the filter, or in position **FULL** if you don't want to limit the frequency range.

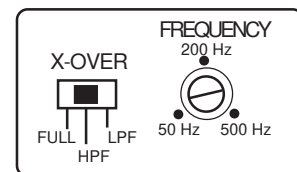

Filter settings rear channels, CH3 + CH4

The low pass filter is mostly used for subwoofers. It will allow low frequencies only and blocks higher frequencies. A typical setting is 50 – 70 Hz.

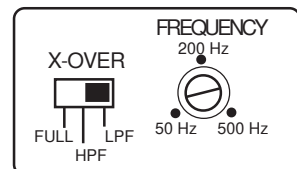

Set the switch in position **LPF** to activate the filter. Set the filter switch in **FULL** position if you want to run the amplifier in full range mode.

TWO SUBWOOFERS

It is also possible to connect two subwoofers in bridge mode to RM40.

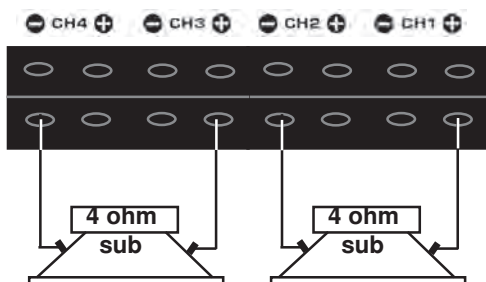

Use the LPF low pass filters on all channels.

For power wiring, see page 4

For high or low level input wiring, see page 5



Testing

Before you finish the installation, you should do the following tests to make sure the wiring is correct and everything is operating properly.

Reconnect Battery

When wiring is complete, reconnect the battery negative terminal.

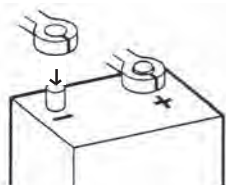

Test power wiring

1. Turn on the head unit but do not turn up the volume. The amplifier power light should come on. If not, check the remote and +12 volt wires. Also check the ground connection.
2. Turn up the head units volume slightly. All speakers should operate. If not, check wiring connections at amplifier and speakers.

Test speaker connections

Make sure the speakers are connected right. Use the balance control on the head unit to make sure right channel is on right speaker etc. If speakers don't play at all, one or both speaker wires may be disconnected.

Troubleshooting

If problems occur during the installation, or later, this guide might help you to find out what's wrong.

THE AMPLIFIER IS DEAD:

1. Check power lead, ground and remote connections at the amplifier using a multi meter.
2. Check the battery terminal connections.
3. Check the power lead fuse or circuit breaker. If fuse damage continues, inspect the power lead for short circuits.
4. Check the amplifier protection fuses. Are these broken change to new ones with the same value. If short circuiting continues, contact your local DLS dealer. A fault may exist in the amplifier.
5. To start the amplifier requires a remote voltage of 9-15 volt. Check the voltage with a multi meter.

AMPLIFIER PROTECTION FUSE BLOWS AT LOW VOLUME :

1. One or more speaker cables are shorted. Make an insulation test with a multi meter. The cables must not have a connection to earth.

THE AMPLIFIER TURNS OFF AFTER 10 - 30 MINUTES.

The amplifier is overheating due to inadequate ventilation. Check mounting position is free from obstruction.

Do this:

1. Move the amplifier to a place with better ventilation.
2. Install one or two fans to cool down the heat-sink.
3. Overheating can also be caused by an impedance load below the level permitted.

NO OUTPUT FROM ONE OR MORE SPEAKERS:

Check the following:

1. Balance control position.
2. Fader control position.
3. Speaker cable connections to both amplifier and drivers.
4. Signal lead plugs and cables.
5. Change left and right signal lead plugs in the amplifier to see if the problem moves to a different speaker, the lead has a fault. If the problem remains, the speaker or amplifier are at fault.



Professional Tip:

NOISE PROBLEMS

WHINING NOISE VARYING WITH ENGINE REVOLUTIONS:

Do this:

1. Rewire the power supply (12 V) to source unit direct from battery.
2. Rewire ground wire from source unit to clean position on chassis.
3. Check all power connections to ensure that they are clean and tight.
4. Check quality of system ground connection.
5. Install a Power Cap capacitor. This can be helpful against most noise problems.

CONSTANT WHINING NOISE:

Do this:

1. Ensure that all equipment has a common ground point.
2. Check quality of earth strap connection from battery negative terminal to chassis.
3. Disconnect signal cables from amplifier to see if noise disappears. If so the leads are picking up noise. Test this by laying a new cable over the seats and reconnecting to the amplifier. If the noise does not return, re-route original cable away from source of interference.

If noise remains regardless of cable position, try to use so called Quasi-balanced signal cables. DLS PRO-cables are Quasibalanced.

Professional Tip:

Installing in trunk

When installing the amplifier in the trunk, run the power wires along the same path as the other vehicle wiring. Many cars have insulated channels for wiring. you will have to remove the door sill trim and the carpet.

Professional Tip:

Crimp connections

Purchase crimp connectors and crimping tool. Connectors are color coded.

1. Strip 1/4 inch (6 mm) of insulation from the wire.
2. Insert into connector
3. Crimp tightly

Professional Tip:

SPEAKER POLARITY CHECK.

All speakers in a car audio system should be connected in phase (the same polarity). All speaker cones must move in the same direction. Out of phase speakers will cause a lack of bass, and a poor stereo soundstage.

Checking polarity:

Hold the - connection of the speaker wire to the - terminal of a 1,5 Volt flashlight battery. Tap the + wire on to the + terminal of the battery, and observe the movement of the cone. The cone should move outwards when the wire touches the battery, and inwards when the battery is removed. If it is the other way around, the speaker has been connected backwards and it must be removed and connected correctly.

If your system also has a subwoofer connected through a passive 6 or 12 dB crossover, try to connect this with various polarity and judge what sounds best. The phase shift in passive crossovers sometimes makes it necessary to change polarity.

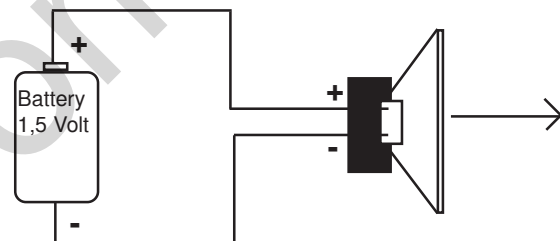

NOTE! Tweeters can not be tested this way, double check the connections instead.

Professional Tip:

Securing wires

Use wire ties to bundle together when possible. (But never bundle speaker wires or signal cables together with power wires.)



Professional Tip:

Speaker and power wires

Do not run speaker and power wires next to each other. Power wires can generate a "siren" sound in the speakers. Run speaker and power wires on opposite sides of the car.



Specifications

Reference	RM10	RM15	RM20
Number of channels	1	1	2
Class	D	AB	AB
Power in 4 ohm (0,1% THD, 13,6V)	150 W (0,2% THD)	200 W	2 x 60 W
Power in 4 ohm (1% THD, 14,4V)	175 W	290 W	2 x 80 W
Power in 2 ohm (0,2% THD, 13,6V)	250 W	340 W	2 x 80 W
Power in 2 ohm (1% THD, 14,4V)	285 W	450 W	2 x 110 W
Bridge mode 4 ohm (13,6V)	-	-	1 x 190 W
Bridge mode 4 ohm (14,4 V)	-	-	1 x 230 W
Signal / noise ratio, A-weighted	>100 dB	>100 dB	>100 dB
Damping factor	>100	>100	>100
Freq. response	15 Hz - 200 Hz	10 Hz - 35 kHz	10 Hz - 35 kHz
Input impedance, low level	47 kohm	47 kohm	47 kohm
Input impedance, high level	220 ohm	220 ohm	220 ohm
High level input with auto start	Yes	Yes	Yes
Line out (RCA)	Yes	Yes	Yes
Input sensitivity	0,25 - 8V	0,25 - 8 V	0,25 - 8V
BASS EQ @ 80 Hz variable	-	-	0 - +6 dB
SUB EQ @ 40 Hz variable	0 - +6 dB	0 - +6 dB	-
Filter High pass / subsonic	built-in 25 Hz	15 - 150 Hz	15-500 Hz*
Filter Low pass, variable	50-150 Hz	50 - 500 Hz	50-500 Hz*
* ON-OFF switch			
Remote sub level control	Yes	-	-
Phase shift 0-180° switch	Yes	Yes	-
Built-in cooling fan	-	Yes	-
Current draw, idle	0,5 A	0,7 A	0,5 A
Max. current draw	40 A	50 A	25 A
Fuse	2 x 20 A	3 x 20 A	1 x 25 A
Dimensions HxWxD(mm)	55x189x212	55x189x312	55x189x212
Dimensions (inch)	2,16x7,44x8,35	2,16x7,44x12,3	216x7,44x8,35
Weight	2 kg	2,9 kg	1,8 kg

All power figures are RMS measured @ 13,6V DC, 0,1% THD. Power figures @1% THD, 14,4V are measured according to CEA2006 standard.

Reference	RM30	RM40
Number of channels	3	4
Class	AB	AB
Power in 4 ohm (0,1% THD, 13,6 V)	2 x 60 W	4 x 55 W
Power in 4 ohm (1%THD, 14,4 V)	2 x 75 W	4 x 70 W
Power in 2 ohm (0,2% THD)	2 x 70 W	4 x 75 W
Power in 2 ohm (1% THD, 14,4V)	2 x 100 W	4 x 100 W
Bridge mode 4 ohm (13,6 V)	1 x 310 W	2 x 150 W
Bridge mode 4 ohm (14,4 V)	-	2 x 175 W
Power mono channel in 4 ohm	1 x 170 W	-
Power mono channel in 2 ohm	1 x 260 W	-
Signal / noise ratio, A-weighted	>100 dB	>100 dB
Damping factor	>100	>100
Freq. response	10 Hz - 35 kHz	10 Hz - 35 kHz
Input impedance, low level	47 kohm	47 kohm
Input impedance, high level	220 ohm	220 ohm
High level input with auto start	Yes	Yes
Line out (RCA)	No	No
Input sensitivity	0,25 - 8V	0,25 - 8V
Phase shift switch	0 /180 degrees	-
High pass filter, all channels	-	50 - 500 Hz*
Low pass filter, all channels	-	50 - 500 Hz*
High pass filter, front channels	50 - 150 Hz	-
Low pass filter, mono channel	50 - 120 Hz	-
* ON/OFF switch		
Built-in cooling fan	Yes	Yes
Current draw, idle	0,85 A	0,75 A
Max current draw	60 A	50 A
Fuse	2 x 30 A	2 x 25 A
Dimensions HxWxD(mm)	55x189x352	55x189x312
Dimensions (inch)	2,16x7,44x13,85	2,16x7,44x12,3
Weight	3,3 kg	2,9 kg

All power figures are RMS measured @ 13,6V DC, 0,1% THD. Power figures @1% THD, 14,4V are measured according to CEA2006 standard.

130.com.ua

DLS Svenska AB
P.O. Box 13029
SE-40251 Gothenburg, Sweden
Tel: +46 31 840060
Fax: +46 31 844021
E-mail: info@dls.se
www.dls.se