



PHONES

(044) 360-7-130
(050) 336-0-130
(063) 788-0-130
(067) 233-0-130
(068) 282-0-130

130 Internet store of autogoods

COM.UA



ICQ
294-0-130
597-0-130

SKYPE
km-130

CAR RECEIVERS — Receivers • Media receivers and stations • Native receivers • CD/DVD changers • FM-modulators/USB adapters • Flash memory • Facia plates and adapters • Antennas • Accessories |
CAR AUDIO — Car audio speakers • Amplifiers • Subwoofers • Processors • Crossovers • Headphones • Accessories | TRIP COMPUTERS — Universal computers • Model computers • Accessories |
GPS NAVIGATORS — Portable GPS • Built-in GPS • GPS modules • GPS trackers • Antennas for GPS navigators • Accessories | VIDEO — DVR • TV sets and monitors • Car TV tuners • Cameras • Videomodules
• Transcoders • Car TV antennas • Accessories | SECURITY SYSTEMS — Car alarms • Bike alarms • Mechanical blockers • Immobilizers • Sensors • Accessories | OPTIC AND LIGHT — Xenon • Bixenon • Lamps
• LED • Stroboscopes • Optic and Headlights • Washers • Light, rain sensors • Accessories | PARKTRONICS AND MIRRORS — Rear parktronic • Front parktronic • Combined parktronic • Rear-view mirrors
• Accessories | HEATING AND COOLING — Seat heaters • Mirrors heaters • Screen-wipers heaters • Engine heaters • Auto-refrigerators • Air conditioning units • Accessories | TUNING — Vibro-isolation
• Noise-isolation • Tint films • Accessories | ACCESSORIES — Radar-detectors • Handsfree, Bluetooth • Windowlifters • Compressors • Beeps, loudspeakers • Measuring instruments • Cleaners • Carsits
• Miscellaneous | MOUNTING — Installation kits • Upholstery • Grilles • Tubes • Cable and wire • Tools • Miscellaneous | POWER — Batteries • Converters • Start-charging equipment • Capacitors
• Accessories | MARINE AUDIO AND ELECTRONICS — Marine receivers • Marine audio speakers • Marine subwoofers • Marine amplifiers • Accessories | CAR CARE PRODUCTS — Additives • Washer fluid •
Care accessories • Car polish • Flavors • Adhesives and sealants | LIQUID AND OIL — Motor oil • Transmission oil • Brake fluid • Antifreeze • Technical lubricant



In store "130" you can find and buy almost all necessary goods for your auto in Kyiv and other cities, delivery by ground and postal services. Our experienced consultants will provide you with exhaustive information and help you to chose the very particular thing. We are waiting for you at the address

<http://130.com.ua>



How to install and operate the DLS Performance series CA22, CA23, CA31, CA41 and CA51 car audio amplifiers.



Welcome!

This owners manual is written in easy english and uses a lot of drawings to simply the installation and use of the above amplifiers.

Your DLS amplifiers must be installed correctly in order to work well. This manual will show you how to install the amplifier like a pro. Please read the entire manual before beginning the installation.

Install the amplifier yourself if you feel confident with our instructions and if you have the proper tools. However if you feel unsure, turn over the installation job to someone better suited to it.

Warranty Service

This amplifier is covered by warranty, depending on the conditions in the country where it is sold. If the amplifier is returned for service, please include the original dated receipt with the product.



Technical Assistance

For technical assistance ask the shop where the product was sold or the distributor in your very country.

You can always phone the DLS Helpdesk in Sweden + 46 31 84 00 60 or send an e-mail to info@dls.se. Information can also be found on our WEB-site www.dls.se

Contents

Features..... 2
 Installation..... 2
 Tools and materials needed..... 3
 Amplifier installation kit..... 3
 Routing Wires..... 3
Wiring
 Power and Outputs..... 4
 Inputs and controls..... 5
 Input level control..... 6
 Grand Bass,Crossovers..... 6
 CA 31, CA 41, CA 51 Crossovers... 7

CA 22 and CA 23 speaker wiring:
 Front speakers..... 8
 Subwoofer..... 8

CA 31 speaker wiring:
 Front speakers..... 9
 Subwoofer..... 9

CA 41 speaker wiring:
 Four speakers..... 10
 Two speakers + bridged subwoofer. 10
 Two way front system with active crossovers..... 11

CA 51 speaker wiring:
 Four speakers..... 12
 Subwoofer..... 12

Testing..... 13
 Troubleshooting..... 13
 Professional tips..... 14
 Specifications..... 15

All models include

- ◆ RCA inputs
- ◆ High Level input
- ◆ Continuous variable low pass and/or high pass crossover
- ◆ Bass boost feature (only on CA23 & CA41)
- ◆ Remote turn on / off
- ◆ Automatic remote turn on/ off on high level input without connecting any remote wire
- ◆ Electronic protection circuitry against short-circuit, DC offset and thermal overload. Bridgeable design to direct full power to one or two subwoofers etc.

Installation

Before you begin installation

Before you begin you need to read the manual, to have some tools, cables and other material available. There is one such list of material on the following page.

Amplifier location

Important

Allow air circulation around the amplifier.

The DLS Performance series of amplifiers have a compact design that allows great flexibility in mounting. You can mount it under a seat or in the trunk.

When you select a location, do remember that the amplifier generates a lot of heat.

Choose a location where air can circulate freely around the amplifier. Do not cover the amplifier with carpets or hide behind trim panels.

Do not mount the amplifier in an inverted or upside down position.

Check all locations and placements carefully before making any cuts, drilling any holes or making any connections.

This is the best way to mount the amplifier to get the best cooling.

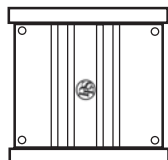

Disconnect Battery

Before starting the installation, always disconnect the negative terminal of the battery.

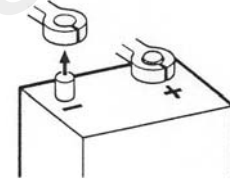

DLS logo on amplifier cooling flange

The DLS logo on top of the amplifier is attached with two 1 mm hex. screws. The logo can be removed and twisted 90 or 180 degrees, and then screwed back in wanted position. The logo can be mounted in four different ways to match your installation.

Removal of side flanges

In order to fasten the amplifier to the surface and connect speaker and power cables, the flanges on the sides must be removed. This is done by loosening the hex screws on top of the amplifier. Use a 3 mm hex key.

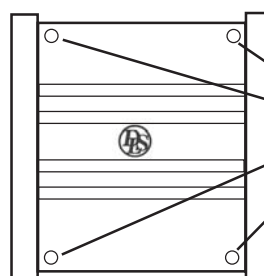

Remove these screws using a 3 mm hex. key for removal of side flange. Remount after fastening the amplifier and connection of the speaker and power cables.

Tools and material needed

Tools:

- ◆ Flat and Phillips screwdrivers
- ◆ Wire cutter
- ◆ Wire stripper
- ◆ Electric drill with drills
- ◆ Crimping tool
- ◆ Digital multimeter or test lamp
- ◆ Wire brush, scraper or a piece of an abrasive sheet to remove paint for a good ground connection
- ◆ Grease to protect the ground connection from oxidation

Material:

- ◆ Speaker wire: minimum 12 AWG = 4 mm² for subwoofers
13 – 16 AWG = 1,5-2,5 mm² for other speakers
- ◆ Sheet metal screws for mounting the amplifier to the amplifier board and the amplifier board to the car + some extra for fuse holder, amplifier ground etc.
- ◆ Electrical insulation tape
- ◆ ½ inch thick plywood or particle board for the amplifier to be mounted upon.

Amplifier installation kit:

If available, buy an amplifier installation kit. It contains normally all you need. This is what you have to buy if you buy the items separately

- ◆ 20- 25 feet = 6- 7.5 meter power cable, minimum AWG 8 = 10 mm² or heavier
- ◆ 1 pc of fuseholder to install close to the car battery + fuse 50 Ampere.
- ◆ 20 feet of AWG 15 = 1,5 mm² wire for remote turn on / off cable from radio.
- ◆ RCA-cable for input from radio.
- 20 feet or 5 meter for trunk installations
- 12 feet or 2 – 3 meter for under seat installations
- ◆ Two ring crimp terminals –one for connection to the battery plus and one for the amplifier ground connection.
- ◆ Two heavy fork crimp terminals to connect + and – to amplifier – but you do only need them if you use heavy cable or to make the installation look nicer.
- ◆ Four to ten fork crimp terminals to connect the speaker cables – but you do only need them if you use heavy cables or want the installation to look nicer.
- ◆ One fork crimp terminal to connect the remote wire to the amplifier, but you need it only to make it look nicer.
- ◆ Four to eight splicers to connect speaker cables to high level input cable, if high level input is used.
- ◆ Wire ties
- ◆ Insulating grommet or insulating tube

Routing wires

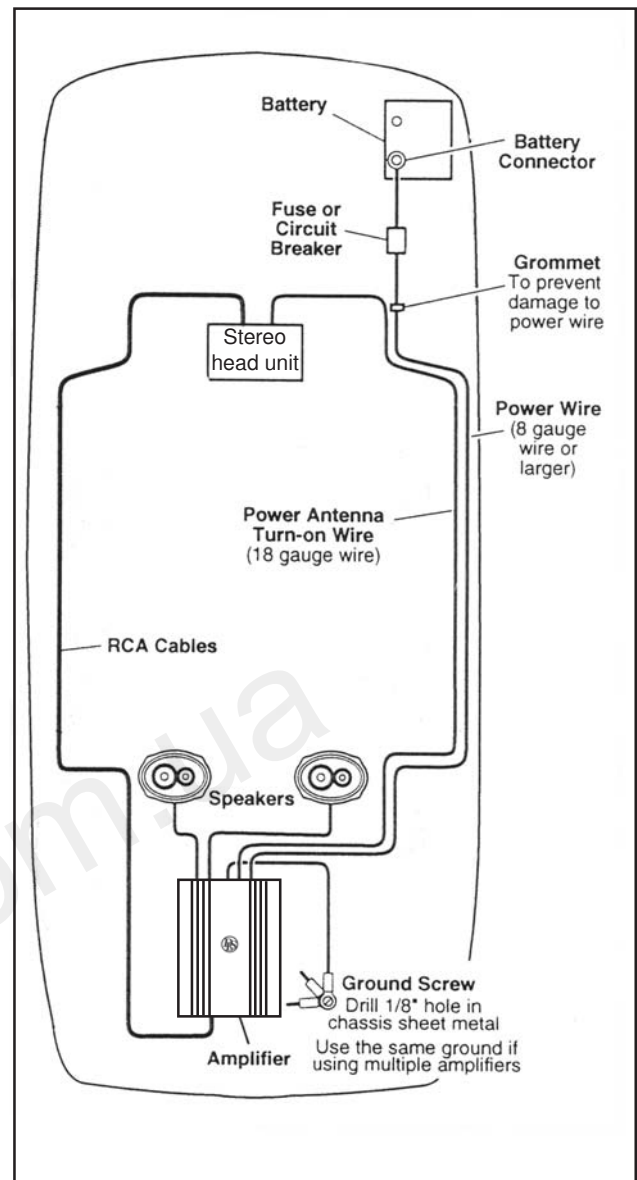

Professional Tip:

If amplifier installation kits are available with different size of power cable, choose the most heavy power cable to improve sound quality and to allow more amplifiers to be installed now or later.

If possible buy AWG 4 = PL 21 mm² cable for best performance.

These are the minimum sizes we recommend for the different models:

CA22	10 mm ² (7AWG)
CA23	16 mm ² (5AWG)
CA31	21 mm ² (4AWG)
CA41	21 mm ² (4AWG)
CA51	21 mm ² (4AWG)

This is for cable lengths up to 5 meters.

The ground cable must have the same size.



Wiring

Power and Outputs

Power terminal (+12V)

Connect the fuse holder as close to the vehicle battery + as possible, using AWG 8 = 10 mm² or heavier cable (see the list on page 3). Use a ring crimp terminal cable to connect to battery +. Apply silicon grease to the fuse to prevent corrosion. Use a 50 Amp fuse for all amplifiers except for CA51 that requires 80 Amp fuse.

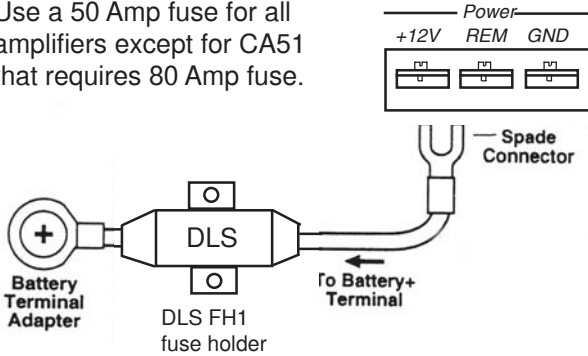

Connect the battery cable by a crimp fork terminal (spade) to the +12 Volt on the amplifier. If you use a AWG 8 = 10 mm² or thinner cable, you can do without the crimp terminal and put the cable right into the connector. Be sure to use a rubber grommet or a plastic insulating tube where the cable passes the firewall or other places when it can easily be jammed. Use wire ties to secure to existing cables in the engine compartment.

Ground Terminal (GND)

Connect to a good chassis ground. The ground connection should be clean, unpainted metal to provide a good electrical connection. Use a wire brush, a scraper or a piece of an abrasive sheet to clean the metal. Use a lock washer or two to secure contact. Protect with silicon grease or by paint applied afterwards.

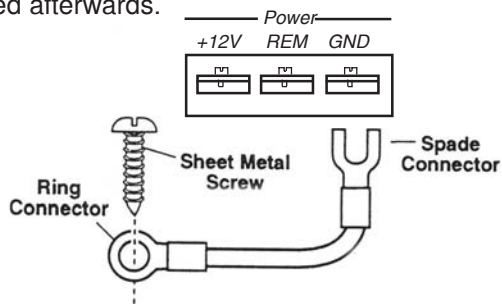

Fuses

Use only one or two 30 ampere ATC blade type fuses. CA 51 uses three 30 ampere fuses. CA22 uses one 25 A fuse.

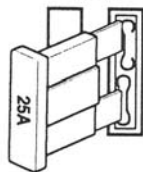

Remote terminal (REM)

For RCA cable signal input:

Connect the radio power antenna lead = remote turn on/off from the car stereo to the amplifier remote connection. This turns on the amplifier whenever the car stereo is turned on. You can either use the built in remote cable in the RCA cable itself or use a separate cable as seen on page 4. Sometimes a small disturbance may enter the amplifier coming from the remote voltage , through the built in remote wire and into the RCA cable. Thus we recommend to use a separate remote wire and run the RCA lead separate from remote wire, power cables and speaker cables. You can either use a crimp fork terminal or insert the cable directly into the amplifier terminal. If there is no remote voltage available from the stereo, you must connect to the ignition key through the radio or any accessories fuse.

For High Level input:

We recommend you to connect the remote wire as described above. The amplifier will produce soft on / soft off operation this way. You must set the Hi level/Low level switch to High level position in this case. In the case that there is no remote voltage available from the car stereo or you want to simplify the installation, the amplifier can be turned on/ turned off by the high level input voltage. This is done when the Hi level/Low level switch is set to Hi level position. There is a small disadvantage that this function gives soft turn on operation but some pop sound when switching off.

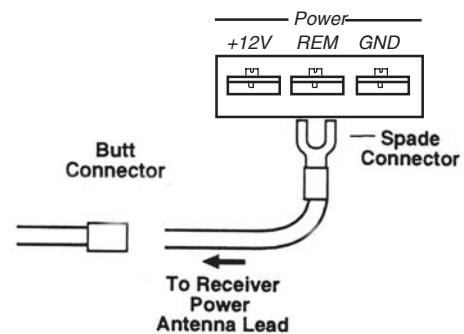

Power Light / Protect light

The power light (green) comes on when the amplifier is turned on.

- Power (Green)
- Protect (Red)

The protect light (red) comes on when the amplifier shuts down from overheating, or a short circuit (speaker failure)

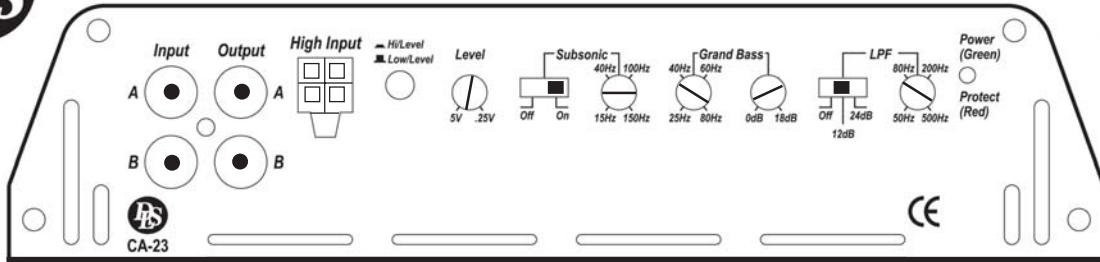

Input Wiring

Inputs may be low level from the RCA output of the car stereo or high level from the car stereo speaker output. Low level = RCA is to prefer for the best sound quality.

Important

On CA22 & CA23 use either the low level or high level input, do not use both at same time.

Low level input

Use a pair of shielded stereo audio cables with RCA type jack. Most trunk-mount amplifiers need a 20 feet RCA cable (appr 5 – 6 meters). Most under the seat installations require 12 feet (2 – 3 meters) RCA cables. Avoid placing the RCA cable close to speaker cables, power cables and remote control cable. Connect to input socket A/B. CA41 and CA51 are also equipped with separate inputs for channel C/D. CA31 & CA 51 has also a separate input for the mono sub channel.

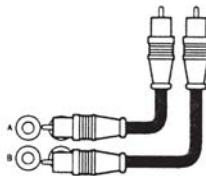

High Level Input

Connect left and right speaker wires coming from the car stereo to the high level input as shown. You must connect both plus and minus as the inputs are balanced, connecting plus only gives lower level and bad sound quality. By changing the polarity of plus and minus, you can change the phase.

CA 22, CA23 & CA31

High Input (C/D Ch)



White: A ch.+
White/Black: A ch.-
Grey/Black: B ch.-
Grey: B ch.+

Hi level input plug on amp.

CA31

On CA31 the high level signal is fed internally to channel C when using high level input.

Automatic turn on when using high level input.

With the Hi/Low input switch set to Hi, the amplifier turns on automatically on high input. You dont need to connect a separate remote wire from your head unit.

CA41

The CA41 four channel amplifier is connected likewise, however we have four channels. You can feed two channels from RCA and two channels using high level input from rear speaker cables.

High Input (A/B Ch)

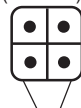

White: A ch.+
White/Black: A ch.-
Grey/Black: B ch.-
Grey: B ch.+

Hi level input plug on amp for CH A/B.

High Input (C/D Ch)



Violet: C ch.+
Violet/Black: C ch.-
Green/Black: D ch.-
Green: D ch.+

Hi level input plug on amp for CH C/D.

CA51

The CA51 five channel amplifier is connected likewise, however only Channels A, B, C and D can be fed with high input. The signal is then connected internally to channel E.

Parallel input on CA 31, CA41 & CA51

Parallel Input CA41

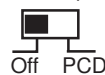

On CA41 the PCD position internally connects the A/B and C/D inputs.

Parallel Input CA31



On CA31 & CA51 the PC (PE) position internally connects the A/B (C/D) input with the input for channel C (E).

Parallel Input CA51



In OFF-position you must use dual signal cables or Y-splits.

RCA Output

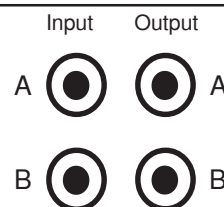

Use RCA Outputs to connect additional amplifiers (not available on CA31 & CA51).



Hi / Low level input switch

To ensure best possible performance from the amplifiers a switch is installed to select between Hi and Low input.

When using High Level input:

Push in the button to position "Hi Level"

When using Low level input:

Push out the button to position "Low Level"



If the switch is set to wrong position, the amplifier still works, but the risk for disturbances or distortion increases.

Input Level control

The input level control, 5V – 0,25 V, matches the output of your radio to the input of the amplifier. After installation is complete, make sure the input of the amplifier is turned down all the way (counter-clockwise at 5V).



Play a tape or CD, make sure all bass or treble settings or equalizer are flat, and turn the volume of the radio up until you just start to hear distortion. Turn the volume control down just a bit. On the amplifier increase the input level control (clockwise or to the right) until you just start to hear distortion, then back the level control just a bit. Now your radio and amplifier levels are matched.

Grand bass on CA23 & CA41

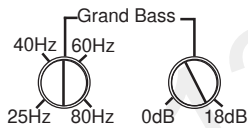

Grand Bass is used to increase the bass volume at an interval of bass frequencies. You can select the center frequency between 25Hz and 80 Hz and the amplification between 0 dB (no amplification) and 18 dB (full amplification).

The slope of the filter is 10 – 12 dB at maximum setting.

This function is used to compensate for the bass box function and to adjust for your own taste of bass. Set level control at 0 dB if you want it to be inoperative.

Phase control CA31 & CA51

The phase control on CA31 & CA51 can be set continuously from 0 - 180 degrees. This is very useful when you want to adjust the bass sound for best front stage image. Start on 0 and turn the control slowly clockwise until you experience that the bass sound is coming from the front. If you dont get the result you want, also try to phase reverse the subwoofer connections and make a new adjustment.



Crossovers

All amplifiers include high pass filter (HPF) and low pass filters (LPF). On CA23 the high pass filter is used as a subsonic filter. All filters are continuously variable and all filters can be switched on and off. CA31 & CA51 also includes a subsonic filter.

Subsonic filter CA31 & CA51

The **Subsonic filter** blocks the very deepest frequencies from reaching the subwoofers. It has a fixed frequency of 25 Hz and can be switched On / Off. For sub channels C (CA31) and E (CA51) only.



High Pass Filter / Subsonic filter

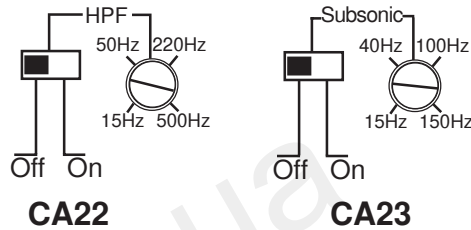

The **HPF** (high pass filter) blocks very low frequencies from reaching the speakers. It is mostly used at say 60 Hz to protect small speakers (like 6 inch and smaller) from deep bass. It can also be used as subsonic filter to take away the very deepest frequencies from a bass box. The typical setting is then around 25 – 40 Hz. In CA23 the high pass filter is designed as a subsonic filter variable from 15 Hz to 150 Hz.

The slope of the High pass filter is 12 dB / octave. The filter can be switched off if you want to run the amplifier in full range mode.

Low Pass Filter

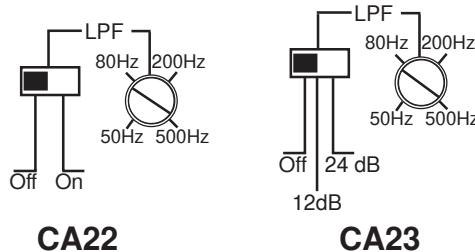

The **LPF** (low pass filter) mostly used for subwoofers. It will allow low frequencies only and blocks higher frequencies.

A typical setting is 50 – 80 Hz.

The filter can be switched in and out. In the CA23 amplifier you can select between two different slopes, 12 dB/ octave or 24 dB/ octave.

Choose the slope and the setting that sounds best in your car.

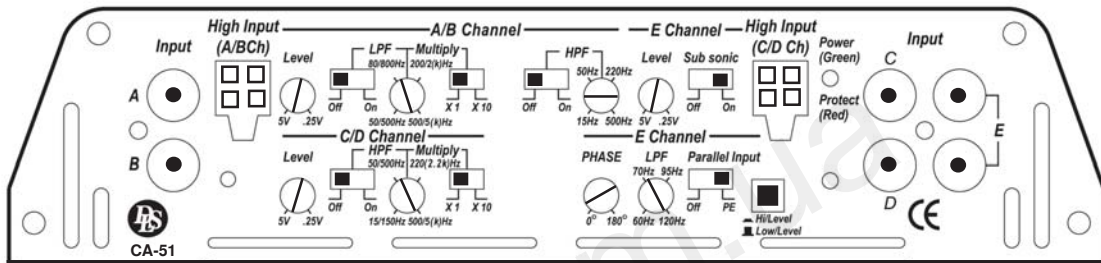
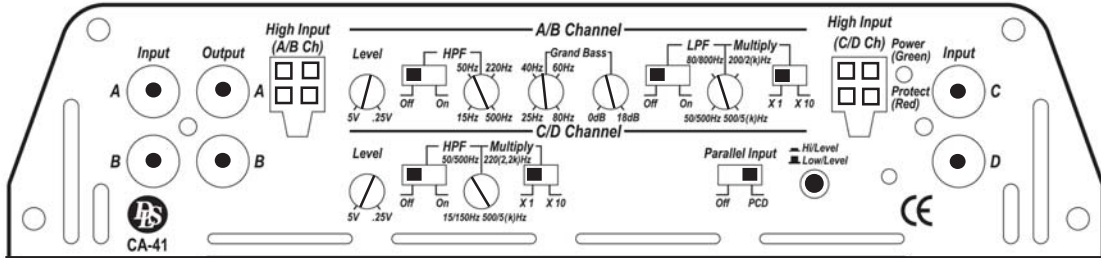
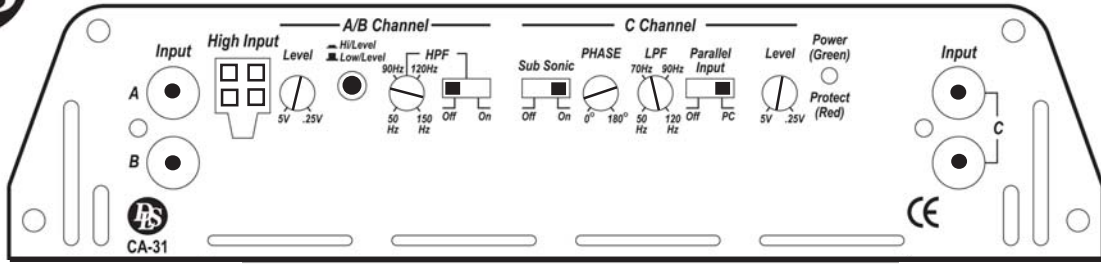

The CA41 is a four channel amplifier. It is mostly used with a front system connected to channels C/ D and a subwoofer connected to channel A/B. You will find speaker wiring and filter setting example on page 10. Please observe the proper settings of the channel A/B LPF multiplier switch and of the channel C/D HPF multiplier switch.

The CA41 can also be used to feed a 2-way front system with active crossovers between midbasses and tweeters. This is described in a speaker wiring and filter setting example on page 11.

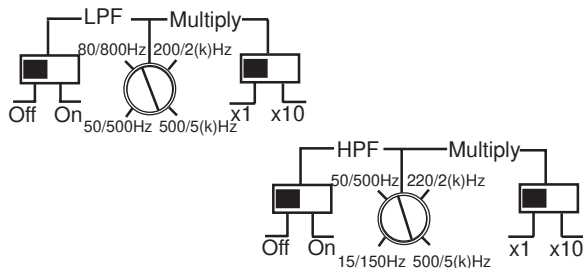

Channel A/B is equipped very much like the CA22 and CA23, however the LPF has a multiplier. Thus the frequency range of the LPF can be varied from 50 Hz – 500 Hz in the x1 position or 500 Hz – 5 kHz in the x10 position. This way we can use this amplifier to feed a 2-way system, where the midbasses are feed from 80 Hz – 4 kHz.

The tweeters connected to channel C/D , operate from 4 kHz upwards using the HPF in multiplier position x 10 150 Hz – 5 kHz.

The CA31 is a three channel amplifier. It has a variable high pass filter, 50-150 Hz, for channel A/ B. The C channel is for subwoofers and has a subsonic filter, a variable low pass filter, 50-120 Hz, and a phase control variable from 0 - 180 degrees. The subsonic filter can be switched IN-OUT and has a fixed frequency of 25 Hz.

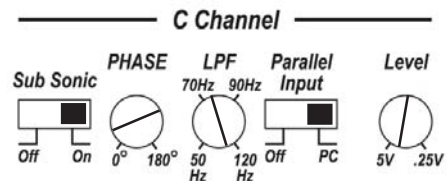

The CA51 is a five channel amplifier. On channel A/B, C/D the filter configuration is exactly the same as for CA41.

Channel E is a subwoofer mono channel with a lowpass filter adjustable from 60 to 120 Hz. Channel E has also a subsonic filter that can be switched IN-OUT. The subsonic filter has a fixed frequency of 25 Hz. The CA51 has also a phase control variable from 0 - 180 degrees

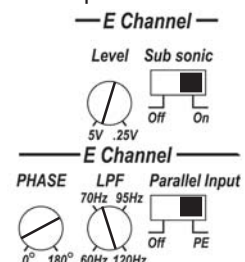

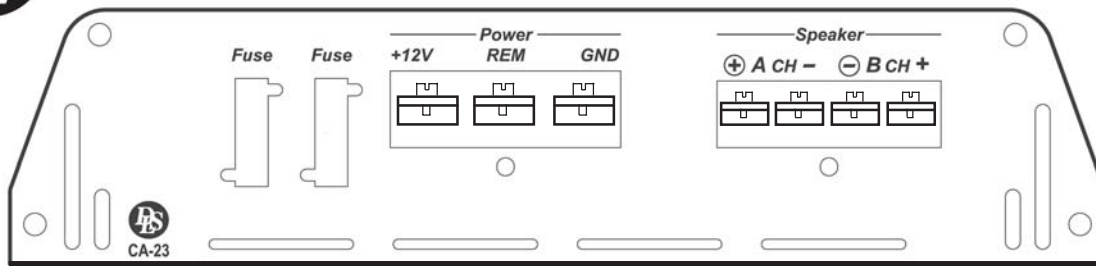

Speaker wiring CA 22 & CA23

Two fullrange speakers to CA22 or CA23

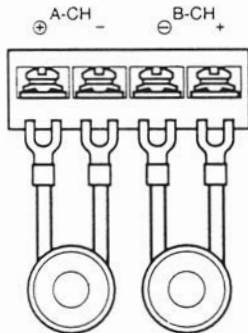

One subwoofer connected in bridge mode to CA22 or CA23

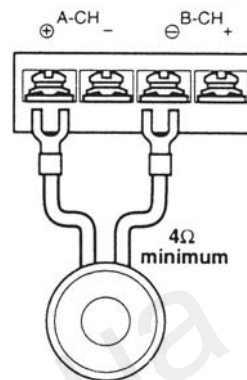

NOTE!

4 ohm minimum load when using bridge mode connection. Lower impedances may damage the amplifier. In bridge mode the amplifier sees a 4 ohm load as 2 ohm.

Filter settings

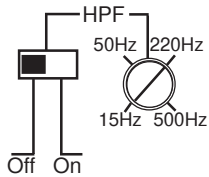

CA22

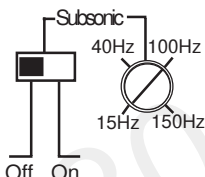

CA23

With the HPF-filter in OFF position the amplifier allows the speakers to play fullrange. If you for some reason want to limit the low bass reproduction switch on the HPF-filter. The typical setting is then around 25 – 40 Hz.

Filter settings

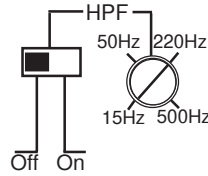

CA22

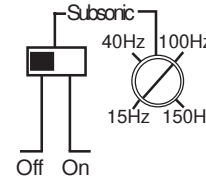

CA23

The HPF filter is here used as subsonic filter to take away the very deepest frequencies. The typical setting is around 25 – 40 Hz.

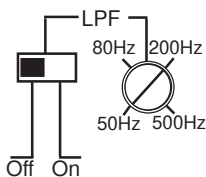

CA22

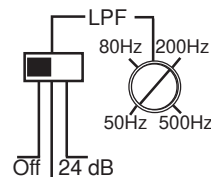

CA23

The LPF-filter should be OFF.

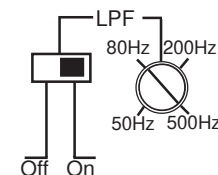

CA22

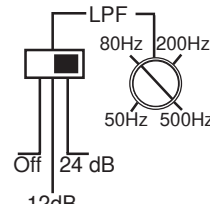

CA23

The LPF will allow low frequencies only and blocks higher frequencies. A typical setting is 70 – 90 Hz. In the CA23 amplifier you can select between two different slopes, 12 dB/ octave or 24 dB/ octave. Choose the slope and the setting that sounds best in your car.

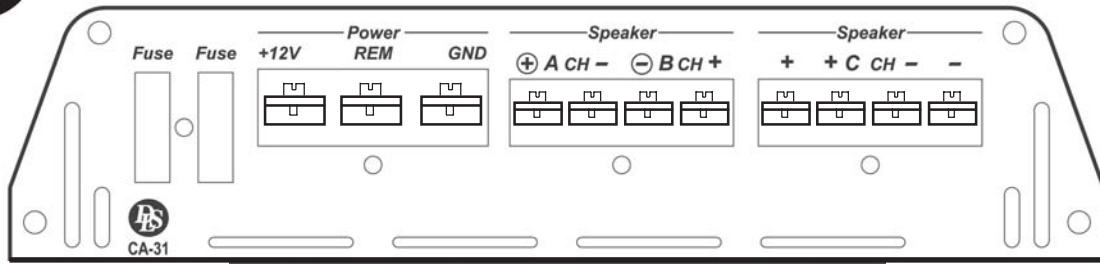

Speaker wiring CA 31

Two fullrange speakers to channel A/B

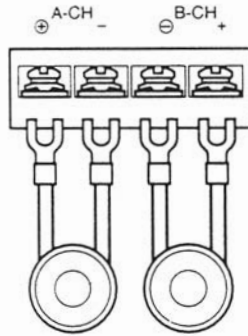

With the HPF-filter in OFF position the amplifier allows the speakers to play fullrange. If you for some reason want to limit the low bass reproduction switch on the HPF-filter. The typical setting is then around 60 – 80 Hz.

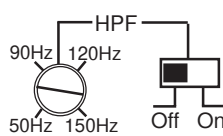

One (or two) 4 ohm subwoofers to channel C

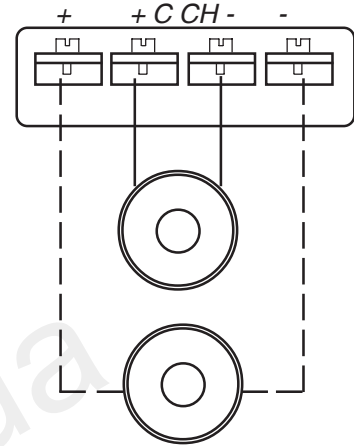

Filter settings channel C

The subsonic filter takes away the very deepest frequencies. Turn on the subsonic filter if you want to remove these frequencies.

The LPF will allow low frequencies only and blocks higher frequencies. A typical setting is 70 – 100 Hz.

The phase control can be set continuously from 0 - 180 degrees. This is very useful when you want to adjust the bass sound for best front stage image. Start on 0 and turn the control slowly clockwise until you experience the bass sound coming from the front. If you dont get the result you want, also try to phase reverse the subwoofer connections and make a new adjustment.

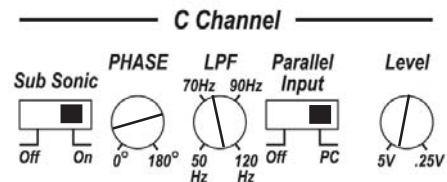

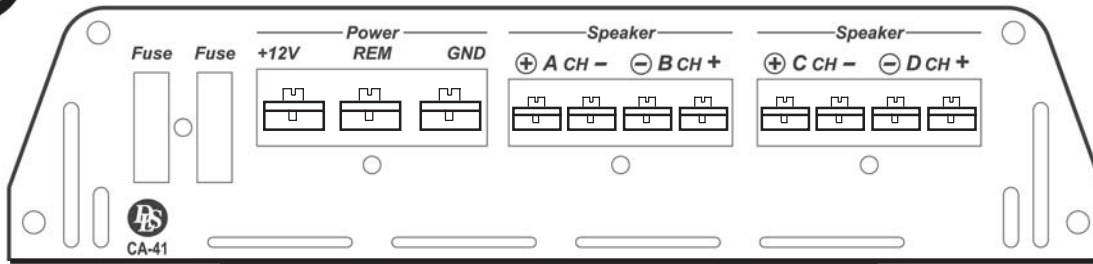

Speaker wiring CA 41

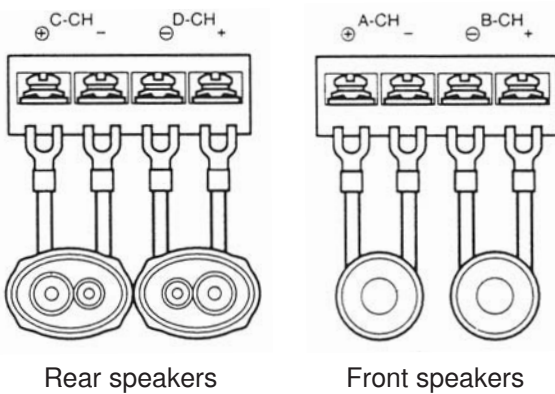
Four fullrange speakers to CA41. One pair in front and one pair in rear.

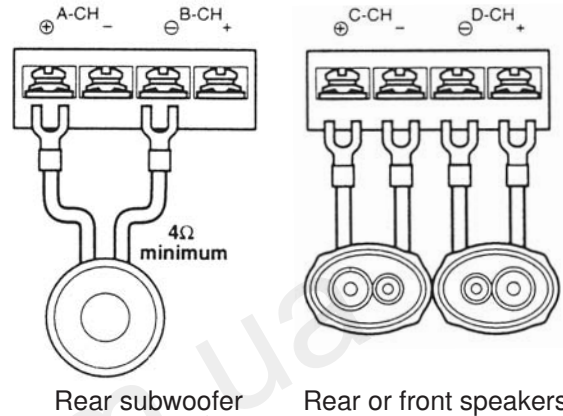
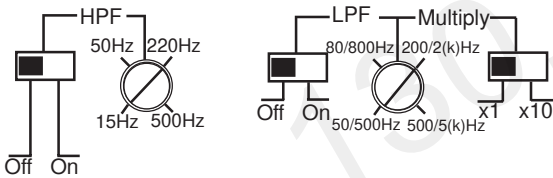

Two fullrange speakers and one subwoofer to CA41.

Filter settings A/B Channels

With the HPF-filter in OFF position the amplifier allows the speakers to play fullrange. If you for some reason want to limit the low bass reproduction switch on the HPF-filter. The typical setting is then around 60 – 80 Hz. The LPF-filter switch should be in OFF-position

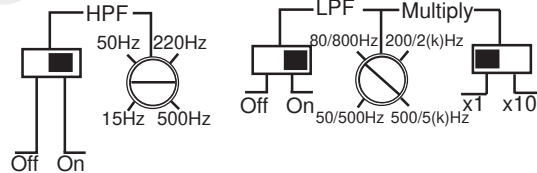
Filter settings A/B Channels

The subwoofer should be connected to channel A/ B in bridge mode. The Grand Bass mode can now be used for the subwoofer. Set the HPF-filter switch to ON-position. Adjust the filter setting to 25-40 Hz. Set the LPF-filter switch to ON-position and the Multiply switch to x1. Adjust the frequency setting to 70-90 Hz.

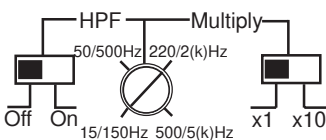
Filter settings C/D Channels

With the HPF-filter in OFF position the amplifier allows the speakers to play fullrange. If you for some reason want to limit the low bass reproduction switch on the HPF-filter. The typical setting is then around 60 – 80 Hz.

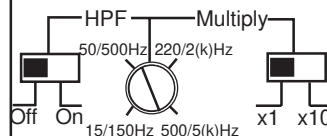
Filter settings C/D Channels

With the HPF-filter in OFF position the amplifier allows the speakers to play fullrange. If you for some reason want to limit the low bass reproduction switch on the HPF-filter. The typical setting is then around 60 – 80 Hz.

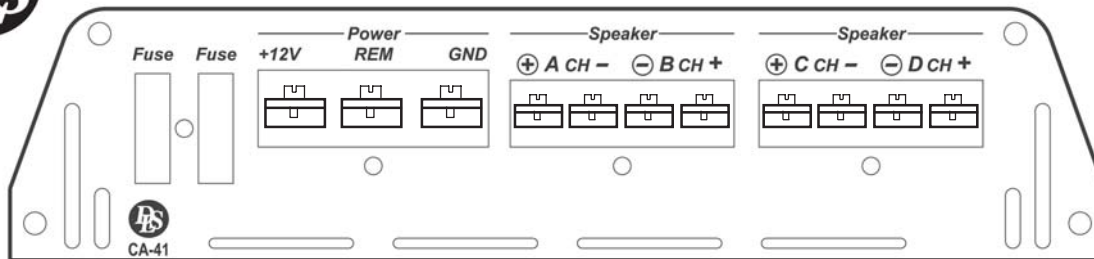

Speaker wiring CA 41

One 2-way speaker system to CA41 using active crossover between tweeter and midrange

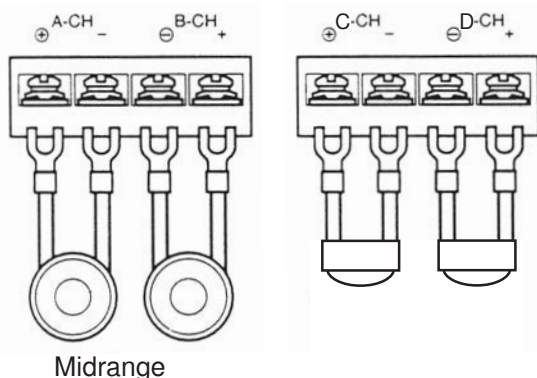

Filter settings A/B Channels

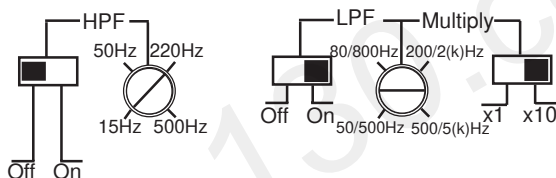

We want a crossover point of 4 kHz between tweeter and midrange. If you for some reason want to limit the low bass reproduction switch on the HPF-filter. The typical setting is then around 60 – 80 Hz. Switch the LPF-filter switch to ON and the Multiply switch to x10 position. Now you can adjust the filter setting from 500 Hz to 5 kHz. Adjust the setting to 4 kHz.

Filter settings C/D Channels

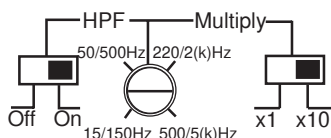

Channel C/D are used for tweeters and must be set to play from 4 kHz and up. The HPF-filter switch must be ON and the multiply switch in x 10 position. Now you can adjust the filter setting from 150Hz to 5 kHz. Adjust the setting to 4 kHz.

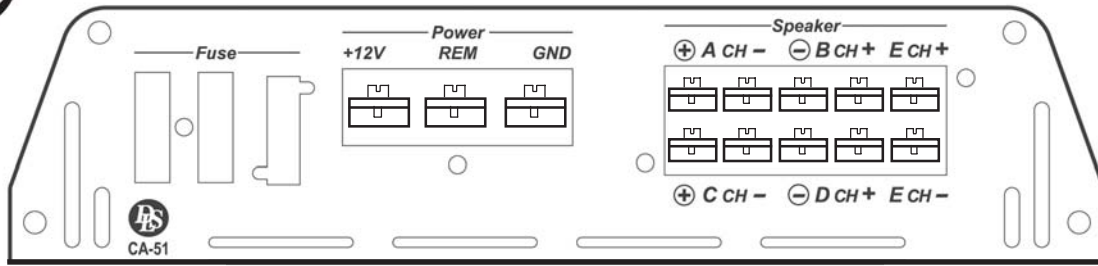

Speaker wiring CA 51

Four fullrange speakers to CA51. One pair in front and one pair in rear.

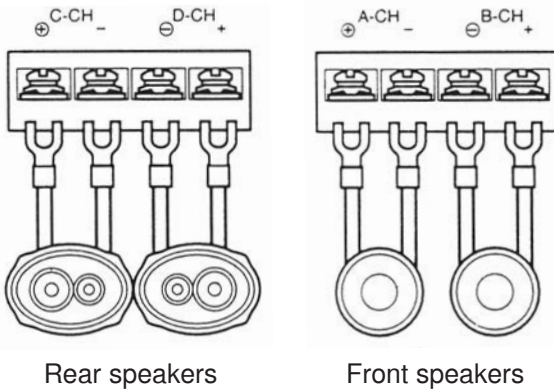

Filter settings A/B Channels

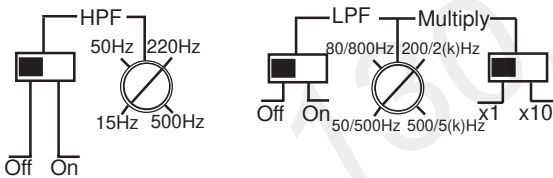

With the HPF-filter in OFF position the amplifier allows the speakers to play fullrange. If you for some reason want to limit the low bass reproduction switch on the HPF-filter. The typical setting is then around 60 – 80 Hz. The LPF-filter switch should be in OFF-position

Filter settings C/D Channels

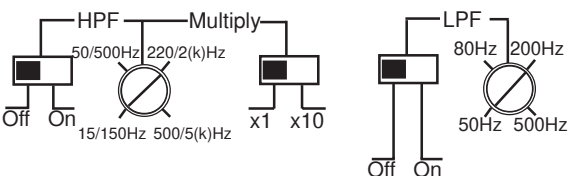

With the HPF-filter in OFF position the amplifier allows the speakers to play fullrange. If you for some reason want to limit the low bass reproduction switch on the HPF-filter. The typical setting is then around 25 – 40 Hz. The LPF-filter switch should be in OFF-position

Subwoofer to CA51

The CA51 is a five channel amplifier. On channels A/B, C/D the filter configuration is exactly the same as for CA41. For speaker connections on these channels you can use the examples for CA41.

Channel E is a subwoofer mono channel with a lowpass filter adjustable from 50 to 500 Hz. Channel E has also a subsonic filter that can be switched IN-OUT. The subsonic filter has a fixed frequency of 25 Hz.

You can connect one 4 ohm subwoofer to channel E.

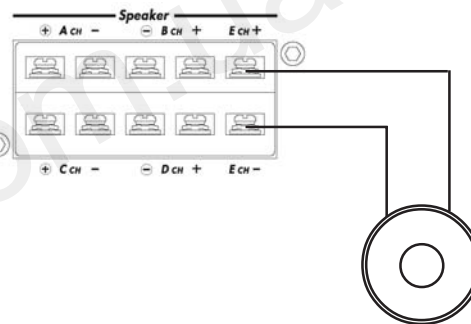

Filter settings E Channel

The subsonic filter takes away the very deepest frequencies. Turn on the subsonic filter if you want to remove these frequencies.

The LPF will allow low frequencies only and blocks higher frequencies. A typical setting is 70 – 100 Hz.

The phase control can be set continuously from 0 - 180 degrees. This is very useful when you want to adjust the bass sound for best front stage image.

Start on 0 and turn the control slowly clockwise until you experience the bass sound coming from the front. If you dont get the result you want,

also try to phase reverse the subwoofer connections and make a new adjustment.

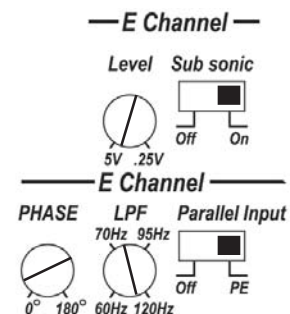

Testing

Before you finish the installation, you should do the following tests to make sure the wiring is correct and everything is operating properly.

Reconnect Battery

When wiring is complete, reconnect the battery negative terminal.

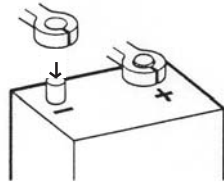

Test power wiring

1. Turn on the head unit but do not turn up the volume. The amplifier power light should come on. If not, check the remote and +12 volt wires. Also check the ground connection.
2. Turn up the head units volume slightly. All speakers should operate. If not, check wiring connections at amplifier and speakers.

Test speaker connections

Make sure the speakers are connected right. Use the balance control on the head unit to make sure right channel is on right speaker etc. If speakers don't play at all, one or both speaker wires may be disconnected.

Troubleshooting

If problems occur during the installation, or later, this guide might help you to find out what's wrong.

THE AMPLIFIER IS DEAD:

1. Check power lead, ground and remote connections at the amplifier using a multi meter.
2. Check the battery terminal connections.
3. Check the power lead fuse or circuit breaker. If fuse damage continues, inspect the power lead for short circuits.
4. Check the amplifier protection fuses. Are these broken change to new ones with the same value. If short circuiting continues, contact your local DLS dealer. A fault may exist in the amplifier.
5. To start the amplifier requires a remote voltage of 9-15 volt. Check the voltage with a multi meter.

AMPLIFIER PROTECTION FUSE BLOWS AT LOW VOLUME :

1. One or more speaker cables are shorted. Make an insulation test with a multi meter. The cables must not have a connection to earth.

THE AMPLIFIER TURNS OFF AFTER 10 - 30 MINUTES.

The amplifier is overheating due to inadequate ventilation. Check mounting position is free from obstruction.

Do this:

1. Move the amplifier to a place with better ventilation.
2. Install one or two fans to cool down the heat-sink.
3. Overheating can also be caused by an impedance load below the level permitted.

NO OUTPUT FROM ONE OR MORE SPEAKERS:

Check the following:

1. Balance control position.
2. Fader control position.
3. Speaker cable connections to both amplifier and drivers.
4. Signal lead plugs and cables.
5. Change left and right signal lead plugs in the amplifier to see if the problem moves to a different speaker, the lead has a fault. If the problem remains, the speaker or amplifier are at fault.

Professional Tip:

NOISE PROBLEMS

WHINING NOISE VARYING WITH ENGINE REVOLUTIONS:

Do this:

1. Rewire the power supply (12 V) to source unit direct from battery.
2. Rewire ground wire from source unit to clean position on chassis.
3. Check all power connections to ensure that they are clean and tight.
4. Check quality of system ground connection.
5. Install a Power Cap capacitor. This can be helpful against most noise problems.

CONSTANT WHINING NOISE:

Do this:

1. Ensure that all equipment has a common ground point.
2. Check quality of earth strap connection from battery negative terminal to chassis.
3. Disconnect signal cables from amplifier to see if noise disappears. If so the leads are picking up noise. Test this by laying a new cable over the seats and reconnecting to the amplifier. If the noise does not return, re-route original cable away from source of interference.

If noise remains regardless of cable position try to use so called Quasi-balanced signal cables. DLS PRO-cables are Quasibalanced.

Professional Tip:

Installing in trunk

When installing the amplifier in the trunk, run the power wires along the same path as the other vehicle wiring. Many cars have insulated channels for wiring. you will have to remove the door sill trim and the carpet.

Professional Tip:

Crimp connections

Purchase crimp connectors and crimping tool. Connectors are color coded.

1. Strip 1/4 inch (6 mm) of insulation from the wire.
2. Insert into connector
3. Crimp tightly

Professional Tip:

SPEAKER POLARITY CHECK.

All speakers in a car audio system should be connected in phase (the same polarity). All speaker cones must move in the same direction. Out of phase speakers will cause a lack of bass, and a poor stereo soundstage.

Checking polarity:

Hold the - connection of the speaker wire to the - terminal of a 1,5 Volt flashlight battery. Tap the + wire on to the + terminal of the battery, and observe the movement of the cone. The cone should move outwards when the wire touches the battery, and inwards when the battery is removed. If it is the other way around, the speaker has been connected backwards and it must be removed and connected correctly.

If your system also has a subwoofer connected through a passive 6 or 12 dB crossover, try to connect this with various polarity and judge what sounds best. The phase shift in passive crossovers sometimes makes it necessary to change polarity.

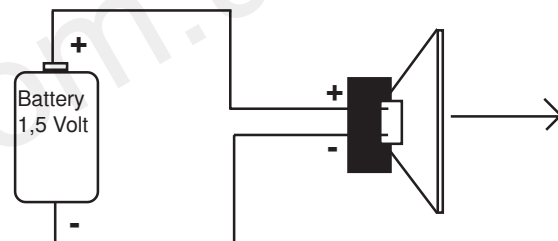

NOTE! Tweeters can not be tested this way, double check the connections instead.

Professional Tip:

Securing wires

Use wire ties to bundle together when possible. (But never bundle speaker wires or signal cables together with power wires.)

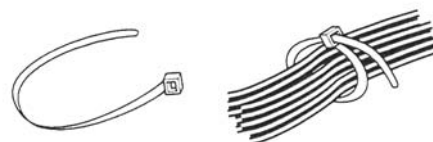

Professional Tip:

Speaker and power wires

Do not run speaker and power wires next to each other. Power wires can generate a "siren" sound in the speakers. Run speaker and power wires on opposite sides of the car.



Specifications

DLS PERFORMANCE	CA 22	CA 23	CA41
Number of channels	2	2	4
Power output, 4 ohm (0,1% THD)	2 x 60 W	2 x 135 W	4 x 70 W
Power output, 2 ohm (0,2% THD)	2 x 100 W	2 x 200 W	4 x 125 W
Power output, 4 ohm bridged	1 x 200 W	1 x 400 W	2 x 200 W
Signal to noise ratio, A-weighted	>100 dB	>100 dB	>100 dB
Damping factor	>100	>100	>100
Frequency response	10 Hz - 35 kHz	10 Hz - 35 kHz	10 Hz - 35 kHz
Input impedance, low level	>10 kohm	>10 kohm	>10 kohm
Input impedance, high level	100 ohm	100 ohm	100 ohm
High level input with auto start	Yes	Yes	Yes
Low output (RCA output)	Yes	Yes	Yes
Input sensitivity	0,25 - 5V	0,25 - 5V	0,25 - 5V
Grand bass adjustable frequency	-	25 Hz - 80 Hz	25 Hz - 80 Hz
Grand bass adjustable gain	0 - 18 dB	0 - 18 dB	0 - 18 dB
Filter highpass /subsonic	15-500 Hz*	15-150 Hz*	see spec. below
Filter lowpass	50-500 Hz*	50-500 Hz*	see spec. below
* can be switched in/out			
Power consumption, idle	0,5 A	0,7 A	1,0 A
Fuse	1 x 25 A	2 x 30 A	2 x 30 A
Dimensions HxWxD(mm)	70x230x268	70x312x268	70x372x268
Dimensions (inch)	2,92x9,06x10,55	2,92x12,28x10,55	2,92x14,65x10,55
Weight	2,7 kg	3,6 kg	4,2 kg

All above output power ratings at 13,8 VDC

DLS PERFORMANCE	CA 31	CA51
Number of channels	3	5
Power output, 4 ohm (0,1% THD)	2 x 65 W	4 x 50 W
Power output, 2 ohm (0,2% THD)	2 x 90 W	4 x 80 W
Power output, 4 ohm bridged	1 x 170 W	2 x 150 W
Power out mono sub ch. 4 ohm	1 x 170 W	1 x 150 W
Power out mono sub ch. 2 ohm	1 x 280 W	1 x 225 W
Signal to noise ratio, A-weighted	>100 dB	>100 dB
Damping factor	>100	>100
Frequency response	10 Hz - 35 kHz	10 Hz - 35 kHz
Input impedance, low level	>10 kohm	>10kohm
Input impedance, high level	100 ohm	100 ohm
High level input with auto start	Yes	Yes
Low output (RCA output)	No	No
Input sensitivity	0,25 - 5V	0,25 - 5V
Variable phase shift control	0-180 degrees	0-180 degrees
Filter highpass CH A & B	50-150 Hz*	see spec.
Filter lowpass CH C / E	50-120 Hz*	see spec.
Subsonic filter CH C / E	Fixed 25 Hz*	Fixed 25 Hz*
* can be switched in/out		
Power consumption, idle	1,0 A	1,0A
Fuse	2 x 30 A	3 x 30 A
Dimensions HxWxD(mm)	70x357x268	70x437x268
Dimensions (inch)	2,92x14,06x10,55	2,92x17,2x10,55
Weight	4 kg	5 kg

Filter configuration CA51

Channel A/B:

Highpass: 15 - 500 Hz*

Lowpass: 50(500) - 500(5k) Hz*
(x 10 switch)

Channel C/D:

Highpass: 15(150)Hz - 500(5k)Hz*
(x 10 switch)

Channel E:

Lowpass 60 Hz - 120 Hz
Subsonic fixed 25 Hz*

* can be switched in/out

Filter configuration CA41

Channel A/B:

Highpass: 15 - 500 Hz*

Lowpass: 50(500) - 500(5k) Hz*
(x 10 switch)

Channel C/D:

Highpass: 15(150)Hz - 500(5k)Hz*
(x 10 switch)

* can be switched in/out

We follow a policy of continuous advancement in development.

For this reason all or part of specifications & designs may be changed without prior notice.



130.com.ua

DLS Svenska AB
P.O. Box 13029
SE-40251 Göteborg, Sweden
Tel: +46 31 840060
Fax: +46 31 844021
E-mail: info@dls.se
www.dls.se