



PHONES

0 (800) 800 130
(050) 462 0 130
(063) 462 0 130
(067) 462 0 130

130
COM.UA

Internet store of
autogoods



SKYPE

km-130

CAR RECEIVERS — Receivers • Media receivers and stations • Native receivers • CD/DVD changers • FM-modulators/USB adapters • Flash memory • Facia plates and adapters • Antennas • Accessories |
 CAR AUDIO — Car audio speakers • Amplifiers • Subwoofers • Processors • Crossovers • Headphones • Accessories | TRIP COMPUTERS — Universal computers • Model computers • Accessories |
 GPS NAVIGATORS — Portable GPS • Built-in GPS • GPS modules • GPS trackers • Antennas for GPS navigators • Accessories | VIDEO — DVR • TV sets and monitors • Car TV tuners • Cameras • Videomodules
 • Transcoders • Car TV antennas • Accessories | SECURITY SYSTEMS — Car alarms • Bike alarms • Mechanical blockers • Immobilizers • Sensors • Accessories | OPTIC AND LIGHT — Xenon • Bixenon • Lamps
 • LED • Stroboscopes • Optic and Headlights • Washers • Light, rain sensors • Accessories | PARKTRONICS AND MIRRORS — Rear parktronic • Front parktronic • Combined parktronic • Rear-view mirrors
 • Accessories | HEATING AND COOLING — Seat heaters • Mirrors heaters • Screen-wipers heaters • Engine heaters • Auto-refrigerators • Air conditioning units • Accessories | TUNING — Vibro-isolation
 • Noise-isolation • Tint films • Accessories | ACCESSORIES — Radar-detectors • Handsfree, Bluetooth • Windowlifters • Compressors • Beeps, loudspeakers • Measuring instruments • Cleaners • Car seats
 • Miscellaneous | MOUNTING — Installation kits • Upholstery • Grilles • Tubes • Cable and wire • Tools • Miscellaneous | POWER — Batteries • Converters • Start-charging equipment • Capacitors
 • Accessories | MARINE AUDIO AND ELECTRONICS — Marine receivers • Marine audio speakers • Marine subwoofers • Marine amplifiers • Accessories | CAR CARE PRODUCTS — Additives • Washer fluid •
 Care accessories • Car polish • Flavors • Adhesives and sealants | LIQUID AND OIL — Motor oil • Transmission oil • Brake fluid • Antifreeze • Technical lubricant



In store "130" you can find and buy almost all necessary goods for your auto in Kyiv and other cities, delivery by ground and postal services. Our experienced consultants will provide you with exhaustive information and help you to choose the very particular thing. We are waiting for you at the address

<https://130.com.ua>

Cabasse



Since 1950

THE PEARL COLLECTION

User guide

THE PEARL

THE PEARL ΛΚΟΥΛ

THE PEARL SUB

Thank you for purchasing a Cabasse speaker. We recommend you read this leaflet carefully to take full advantage of the speaker.

SAFETY INSTRUCTIONS

Explanation of symbols

 Lightning within an equilateral triangle warns of the existence of dangerous, uninsulated high voltage inside the product enclosure, of sufficient value to present a risk of electric shock.

 The exclamation point in an equilateral triangle warned of the existence of instructions usage and maintenance in the documentation attached to this product.

Cleaning - Unplug the unit before cleaning. Do not use cleaning solutions in liquid or aerosol form. Use preferably a damp cloth.

Installation on furniture and stands - Do not place this unit on an unstable stand, such as stands, tripods, tables, shelves, etc. It could fall and cause serious injury to a child or adult who is nearby.

Ventilation - The appliance must be positioned so that it does not interfere with its own ventilation. For example, it should not be installed on a bed, sofa, blanket or similar surfaces that could block its vents. It should not be embedded in confined spaces such as narrow shelves or furniture that could limit the amount of air available to the air intakes.

Power supply - The appliance must only be connected to a power source of the type written in the user manual or in line with the product. If you are unsure of the type of power supplied to your location, contact your dealer or the local power company.

Electrical Overloads -Do not overload power outlets, extension cords, or power reminders. This

could result in fire or electrocution.

Foreign bodies and liquids - Care should be taken never to let foreign objects or liquids enter the unit. They could cause fires or electrocutions. Never pour liquid of any kind into the device.

Maintenance - - In the following cases, you must unplug your appliance and have it checked by a qualified technician:

the power supply or plug has been damaged.
foreign bodies or liquid have entered the device.

the unit has been exposed to rain or has been sprayed with water.

the unit does not seem to be working properly while you are using it as part of its normal operating instructions.

Only handle the controls covered by the user manual. Any other procedure could damage it and require the intervention of a qualified technician.

the unit has fallen or its bodywork is damaged.

the device shows significantly changed performance.

In a disturbed area environment (thunderstorm etc ...), the product may sometimes require shutdown and restart by means of the ON / OFF power switch located on the rear panel of the device to work properly again.

Spare parts - If the repair required the use of spare parts, make sure that the technician has used the references recommended by the manufacturer or having the same charac-

teristics as the original parts. Non-conforming parts may cause fire, electric shock or other.

unit operates safely.

Checks - After any work on the unit, have the technician perform tests to ensure that the

Plastic Bags -Do not leave plastic bags in the box within reach of children to avoid choking.

IMPORTANT SAFETY INSTRUCTIONS!

1. READ these instructions.
2. SAVE these instructions.
3. RESPECT all warnings.
4. FOLLOW all instructions.
5. DO NOT use this unit near water.
6. CLEAN ONLY with a dry cloth.
7. DO NOT obstruct the ventilation holes.
Install according to the manufacturer's instructions.
8. DO NOT install near any heat sources such as radiators, heat registers, stoves, or other apparatus (including amplifiers) that produce heat.
9. DO NOT disable the safety feature of the polarized or ground pin plug. A polarized plug has one blade wider than the other. A ground pin plug has two blades and a third pin for the ground. The wide blade or the third pin is provided for the safety of the user. If the provided plug does not fit into the outlet, have an electrician replace this outlet type that is too old.
10. PROTECT the power cord, making sure that it is not likely to be stomped or crushed, particularly near the

plugs, power strips and its point of exit from the device.

11. USE ONLY the accessories recommended by the manufacturer.

12. Unplug this apparatus during lightning storms or when unused for a long time.

13. CONFIRM any troubleshooting work to a competent professional repairer.

Have the device repaired in case of damage, for example: damaged plug or power cord, liquid spilled on the device or object inserted in the device, unit exposed to rain or moisture, malfunction or after a fall.

14. RUNOFF / HUMIDITY: To prevent fire or shock hazard, do not expose the unit to water or moisture. The appliance must not be exposed to any risk of liquid leaks, no object such as a vase will be placed on or above the appliance.

15. KEEP this product a safe distance away from any naked flame, such as a lit candle.

16. THE MAINS are nor disconnected in the off position, but the circuits are de-powered.



CAUTION: do not ingest the battery, fatal risk of chemical burn within 2 hours. Always keep button cells, new and used, out of reach of children. Seek immediate medical attention if you think that batteries may have been swallowed or inserted anywhere in the body. If the battery compartment no longer closes securely, stop using the product and keep it away from children.

UNPACKING

Open the cardboard box widely and take out the different elements one by one. If any of the items on the carton appear to be damaged, do not use it, put it back in the original carton and contact your dealer immediately.

Keep your packaging for possible future transport of your system.

THE COMPONENTS OF YOUR SYSTEM

THE PEARL, 1 power cord, 1 remote control, 1 simplified instruction and 1 warranty card.

THE PEARL SUB, 1 power cord, 1 remote control, 1 simplified instruction and 1 warranty card.

THE PEARL AKOYA, 1 power cord, 1 remote control, 1 simplified instruction and 1 warranty card, 1 USB adaptor, 1 RCA-Jack 3.5 mm adapter, 1 sac carry bag.

REMOTE CONTROL KEYS THE PEARL

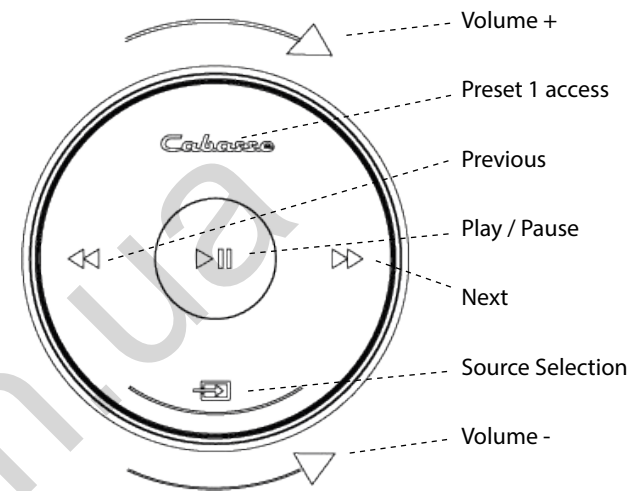

FUNCTIONS

	Bluetooth connection	WLAN/LAN via internet router / box
Loss less audio broadcast		YES
Access to all audio media from the WIFI network (computer ...)		YES
Multi-room		YES
Broadcast smartphone / tablet audio content	YES	YES
Broadcast audio application (youtube ...) from smartphone / tablet	YES	
Broadcasting from USB media		YES
Internet radio and music services		Qobuz, Deezer, Napster, Spotify, Tidal, Vtuner

THE PEARL / THE PEARL SUB

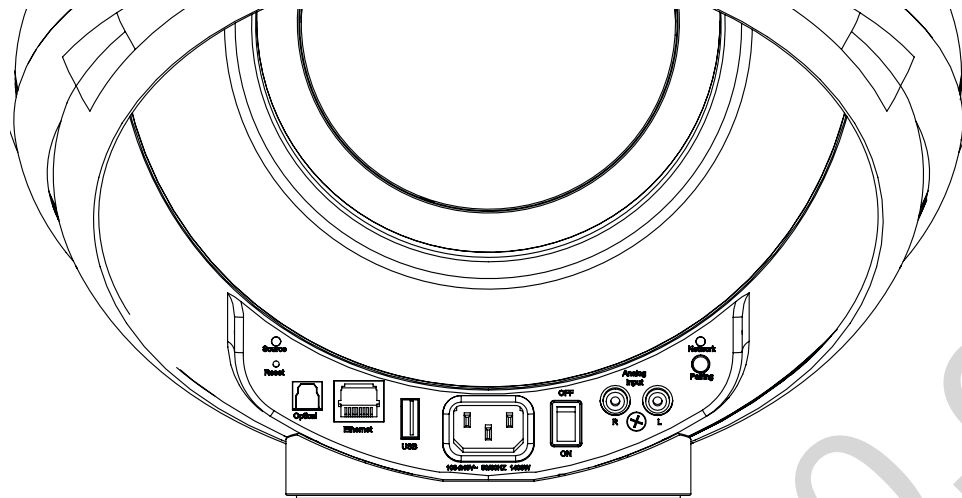

Status LED
Reset
Optical LAN USB
POWER
ON/OFF Analog RCA IN
Pairing LED
Pairing

THE PEARL ΛKOYA

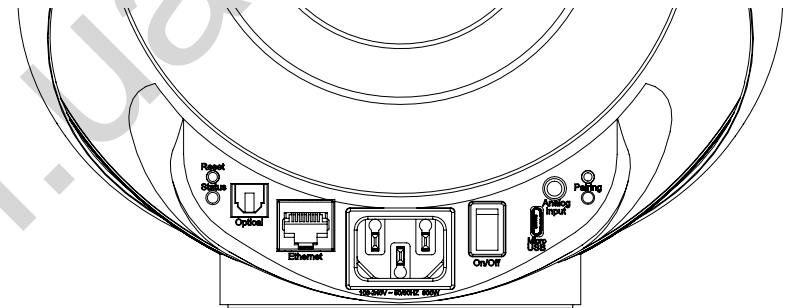

Status LED
Reset
Optical LAN
POWER
ON/OFF
Pairing LED
Pairing
Analog
USB

THE PEARL SUB

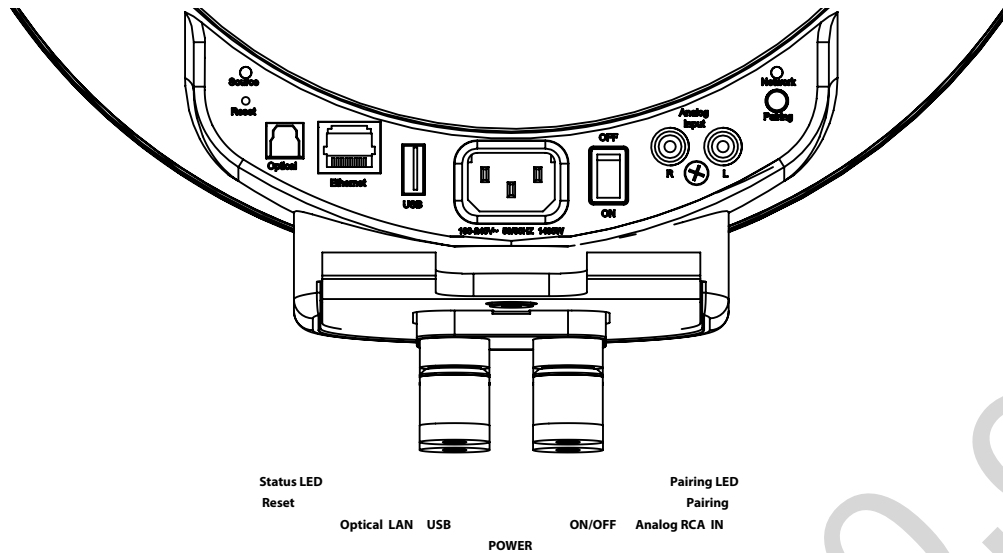

REMOTE CONTROL ACTIVATION

Before first use, unscrew the screw (PH00 screwdriver), remove the cover, remove the protective tab, replace the cover and retighten the screw.

The blue LED on the remote control flashes, waiting for pairing.

PAIRING THE REMOTE CONTROL

- 1- Connect the speaker to the mains.
- 2- Switch on the speaker using the on / off button on the back.
- 3- Press the "pairing" button on the back of THE PEARL / THE PEARL AKOYA / THE PEARL SUB briefly. The LED "pairing" flashes.
- 4- The LEDs on the remote control and THE PEARL stop flashing when the pairing is finalized.

Replacement of the CR-2450 type button-cell: turn the remote control over, unscrew the screw, remove the cover, remove the old battery, insert the new battery, marked "+" to the outside, replace the cover, tighten the screw.

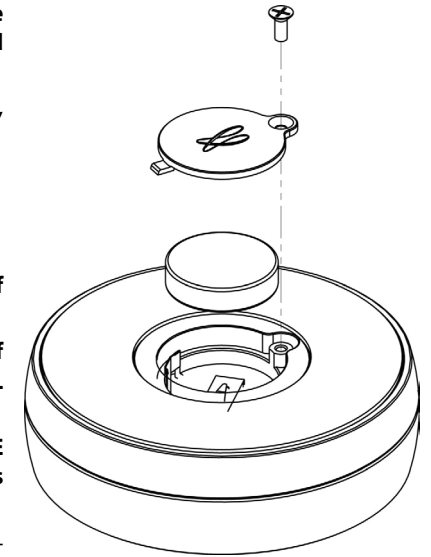

FIRST USE

Connect THE PEARL THE PEARL AKOYA/THE PEARL SUB to the mains with the proper power cord.

THE PEARL / THE PEARL AKOYA / THE PEARL SUB are operational as soon as the LED on the left of the rear panel opposite is lit in solid blue.

A voice announcement, if the volume of THE PEARL / THE PEARL AKOYA/ THE PEARL SUB is not at a minimum, indicates the status of the network connection: current, successful, failure.

STEREO USE WITH 2 THE PEARL / THE PEARL AKOYA / THE PEARL SUB

Use only one remote control to drive a stereo pair. Do not activate another remote in the same room.

COLOR CODES OF THE STATUS LED

- CYAN** DLNA input: wifi, Ethernet, domestic streaming , internet streaming
- GREEN** Spotify Connect
- WHITE** Aux In Input
- YELLOW** Optical input
- BLUE** Bluetooth input
- RED (flashing)** Connexion to network failed
- PURPLE** Automatic calibration running

WIRED AND NON-WIRED INPUTS THE PEARL / THE PEARL SUB

ANALOG INPUT

This input can be connected to an audio source (CD player, MP3 player, smartphone, TV) equipped with an analog output RCA or mini-jack type. Use RCA / RCA cord or minijack / RCA cord (not included)



USB INPUT

This input is only useful for use in Wi-Fi / Ethernet mode (paragraphs 4,5,6 below). Connect a USB stick or hard drive containing audio files to this input to automatically network them. All files in formats recognized by the DLNA server included in THE PEARL are then listed in the Stream Audio Control application and can be read by all Cabasse Stream players connected to the same network. The PEARL USB socket has a 5V - 1A DC power supply for use with a portable hard drive without external power supply.



WIRED AND NON-WIRED INPUTS THE PEARL AKOYA

ANALOG INPUT

This input can be connected to an audio source (CD player, MP3 player, smartphone, TV) equipped with an analog output RCA or mini-jack type. Use the included RCA / mini-jack adapter for RCA-RCA cord or minijack / RCA cord (not included), or a mini-jack/mini-jack cord if the source output is mini-jack type.

Micro-USB INPUT

This input is only useful for use in Wi-Fi / Ethernet mode (paragraphs 4,5,6 below). Connect a USB stick or hard drive containing audio files to this input to automatically network them. Use the supplied Micro-USB/USB adapter if needed. All files in formats recognized by the DLNA server included in THE PEARL are then listed in the Stream Audio Control application and can be read by all Cabasse Stream players connected to the same network. The PEARL micro-USB socket has a 5V - 1A DC power supply for use with a portable hard drive without external power supply.

BLUETOOTH CONNECTION

1. Once the speaker is on, press the "Pairing" button on the back
2. The "Pairing" LED on the back should flash
3. Activate Bluetooth on your mobile
4. Select "THE PEARL XXXX Cabasse" from the list of available devices
5. Once the connection is successful, the LED "Pairing" on the back stops flashing



WIRE CONNECTION (LAN) TO THE ETHERNET NETWORK

The wired Ethernet connection guarantees an optimum and constant transfer rate in any environment. Use this if Wi-Fi mode operation shows untimely cuts or stops of music, signs of a saturated Wi-Fi network, or too much router-to-stream distance.

Connect an RJ45 cable between THE PEARL / THE PEARL AKOYA / THE PEARL SUB and your router (or Box Internet).

The connection is established when the ETH diode changes to solid blue. The WIFI connection is then automatically disabled.

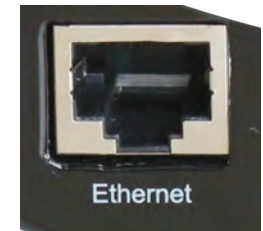

CAUTION: DHCP mode of the router must be enabled.

WIRELESS DLNA CONNECTION (WLAN) TO WIFI NETWORK THE PEARL / THE PEARL AKOYA / THE PEARL SUB

WARNING ! An update of software can start automatically as soon as an internet connection is made.

The beginning and the end of the update are announced by voice.



***Do not turn off or disconnect
THE PEARL,
THE PEARL AKOYA or
THE PEARL SUB
during updates that may require several
minutes.***

on a smartphone or tablet connected to the Wi-Fi network.

1. Install the Cabasse Stream CONTROL App on your tablet / smartphone from "Play Store" for an Android device, or "App Store" for an Apple product.

2. Press "pairing" button for 3 seconds: the blinking pairing LED shows that the device is ready for pairing

3. Open the "settings" or "parameters" App of your smartphone or tablet, select "Wi-Fi " then "THE PEARL XXX" among the list of available networks. You might have to wait a little for THE PEARL to be listed.

4. Open the application and choose "configure this new player"

5. Follow the instructions and upon request select the wi-fi network to be used and enter the network password.

6. Start listening to your favorite music from your smartphone, key or hard drive connected to THE device's USB input, or using sources connected to its analog input or optical input.

The sources connected to the analog and optical inputs of the device can be played by all the other Stream devices belonging to the same zone.



STREAM CONTROL APPLICATION

USE / SYNCHRONIZE WITH A TV SET THE PEARL / THE PEARL AKOYA / THE PEARL SUB

FIRST USE

Open the Stream Control application and launch the tutorial to discover the main features of the application.

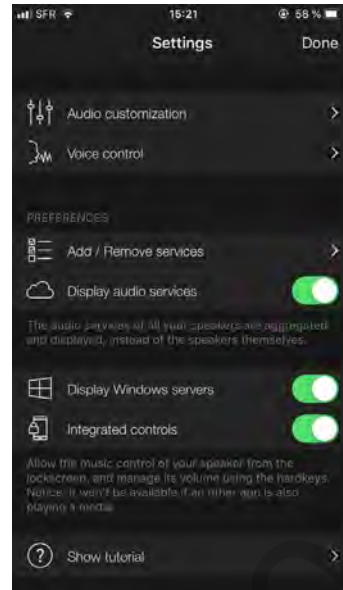
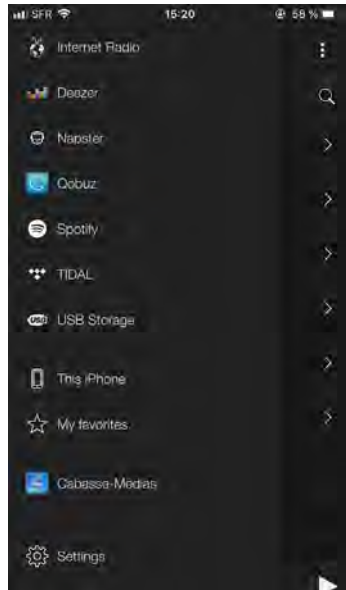

Swipe left-right to open the window giving access to sources and settings. Select "parameters" then "see the tutorial" at the bottom of the "settings" page. Here are the main actions detailed here:

- Navigation in the application
- Selection / configuration of a zone
- Zone Management
- Player options
- Media Playback Menu
- Stereo mode
- Voice control
- Audio Customization
- Favorites
- Services

CONFIGURATION

- 1- Lay the device next to your TV, or a pair of devices on both sides of the TV on a solid stand.
- 2- Leave a space of at least 3 centimeters between the rear wall and the appliance.
- 3- Connect it to the TV with one of the 2 available inputs. Favor the SPDIF coaxial solution:

- SPDIF optical input: Connect the "OPTICAL IN" input to the TV audio output (TV Audio OUT) with the supplied optical cable or equivalent. Make sure that the protective caps at the ends of the optical cable are removed.



- The device analog RCA input: if the TV does not have an SPDIF optical output, connect the "AUX IN" input to the TV's analogue stereo output (RCA TV Audio out) with an RCA-RCA cable, or to the headphone output of the TV with a Jack-RCA cord (not supplied).

- THE PEARL AKOYA analog 3.5mm jack input: if the TV does not have an SPDIF optical output, connect the "AUX IN" input to the TV's analogue stereo output (RCA TV Audio out) with an RCA-RCA cable and the supplied RCA to mini-jack adapter, or to the headphone output of the TV with a Jack-mini-Jack cord (not supplied).



DEACTIVATION OF THE SPEAKERS OF THE TELEVISION

Turn on the TV, open the TV menu, and look for a tab such as Audio, Sound or Speakers. Use the menu function to switch off the TV speakers. This menu item may for example be labeled "Speaker On / Off" for speakers on / off. If this function does not exist, bring the TV sound volume with the TV remote control to the minimum level.

ACTIVATION OF THE OPTICAL OUTPUT OF THE TELEVISION

If there is no sound with an optical connection, set the chosen optical output in the TV menu if necessary.

OPTIMIZATION OF AV SYNCHRONIZATION

In order to provide a stable stereo reproduction with a WLAN connection, the standard delay in the firmware of THE PEARL / THE PEARL AKOYA / THE PEARL SUB can be up to 1000 milliseconds. This delay can be divided by 5 or more for AV purpose by selecting the TV mode instead of the Hi-Fi mode.

AUDIO CUSTOMIZATION

AUTOMATIC CALIBRATION

1: place The Pearl speaker on a stable and not resonant stand or support, with a correct height and orientation according to your favorite listening positions.

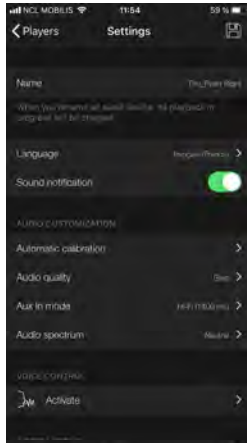

2 : enter into settings / players / The Pearl / automatic calibration



3 : follow the instructions and press "start"



4: stay away from the speaker during calibration. Avoid making noise



4: press OK to exit or follow further instructions

AUDIO OPTIMIZATION

PREFERRED AUDIO SPECTRUM

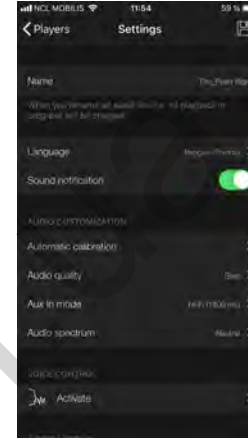

1 : enter into settings / players / The Pearl / Audio Spectrum

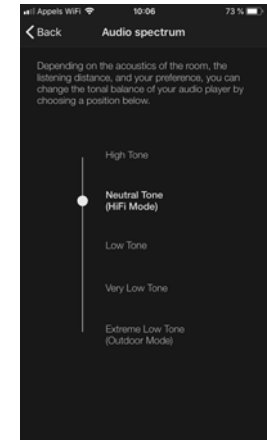

2: select the expected response curve, press "Back" and save the setting. Listen to The Pearl with your favorite cuts. Test another option if the setting does not meet your expectations.

CREATE A STEREO PAIR

2 : TURN THE DUAL MONO ZONE INTO A STEREO ZONE

1 : CREATE A ZONE WITH 2 THE PEARL

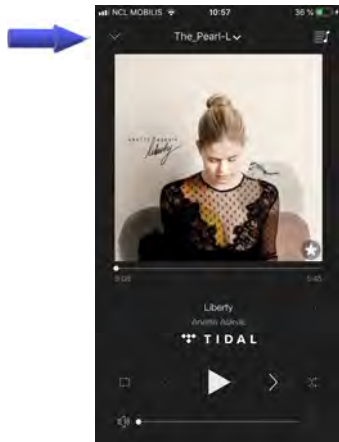

1 : press on the name of the first The Pearl to access to Zone

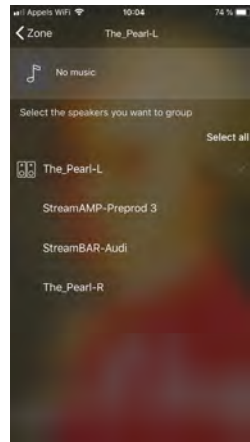

2 : press on the "..." icon to select the first The Pearl

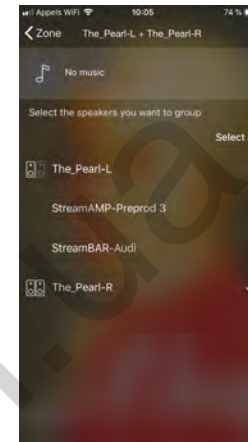

1 : select the left speaker icon for the The Pearl on the left

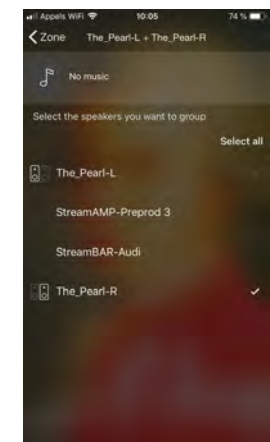

2: select the right speaker icon for the The Pearl on the right . Exit Zone. The stereo pair is listed with a name composed by both speakers'names.

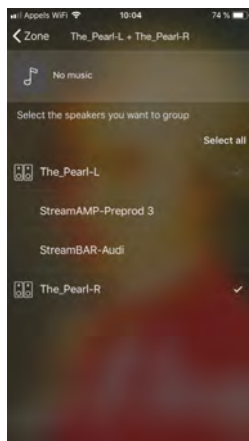

3 : select the second The Pearl and create a group (zone) of 2 speakers.
Note that other Cabasse Stream products can be added to the zone, for instance for a synchronised diffusion in another room

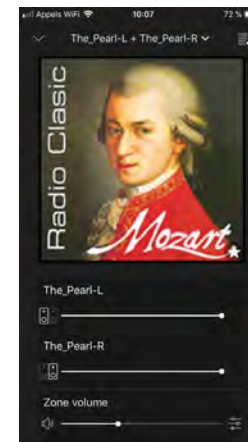

3: Stereo balance: press on the "settings" icon on the right of the volume control bar and access the volume setting of each speaker to adjust the left/right balance if necessary.

STREAMING QUALITY OPTIONS (QOBUZ)

Qobuz (today, and soon other providers) offers several resolution qualities for most of its streaming catalogue. If your internet access does not allow to play high resolution files, please select another position in the audio quality menu



Open "Audio Quality" in settings / Players / The Pearl.

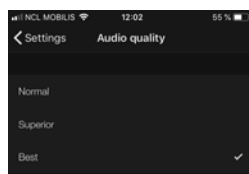

Set the maximum audio quality allowed:
Normal = up to MP3 320 kbs
Superior = up to FLAC 16 Bits / 44 kHz
Best = up to FLAC 24 Bits / 192 kHz

DISPLAY THE AUDIO SPECIFICATIONS OF THE CUT BEING PLAYED

The audio specifications are available on most sources. When playing a music cut open the here-under page by clicking on the icon on the left of the volume control bar.

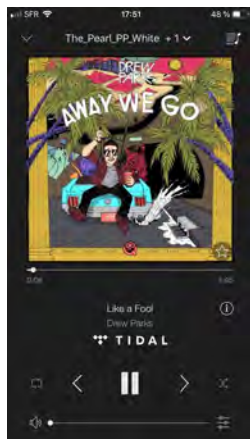

Then click on the "i" info icon to display the specifications

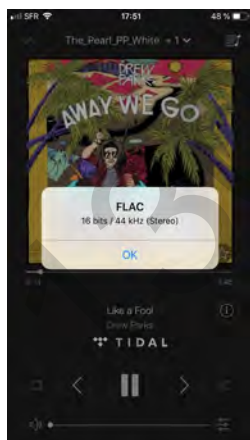

Click on "OK" to erase the specifications window.

DEEE MARKING

Treatment of electrical and electronic devices at the end of their life (applicable in the countries of the European Union).



This crossed-out wheeled bin symbol affixed to the product indicates that this product should not be treated with household waste. It must be handed over to a collection point for the treatment of electrical and electronic equipment at the end of its life. By ensuring that this product is disposed of properly, you will help prevent potential negative consequences for the environment and human health. Recycling materials will help conserve natural resources. For more information about recycling this product, you may contact your municipality, your dump or the store where you purchased the product.

REPLACING THE BATTERY FROM THE REMOTE CONTROL

Turn the remote control over, facing towards the floor. Remove the old battery and replace it with another type CR-2450 coin cell. Dispose of the used battery according to the information below.



WARNING for explosion hazard if battery is incorrectly replaced: use only the same or equivalent battery. Do not expose batteries to excessive heat such as the sun, fire or the like.

Information about batteries and accumulators in the equipment (Applicable in the countries of the European Union).



This crossed-out wheeled bin symbol affixed to a battery or accumulator indicates that the battery or accumulator should not be disposed of as unsorted household waste but should be collected separately from the battery. to make it easier to process and recycle. It must be returned to a collection point for the treatment of used batteries and accumulators. By ensuring that this product is disposed of properly, you will help prevent potential negative consequences for the environment and human health. Recycling materials will help conserve natural resources. For more information about recycling this product, you may contact your municipality, your dump or the store where you purchased the product.

AUTOMATIC UPDATE

THE PEARL software updates are automatic.

The update time is variable and can last up to fifteen minutes during the first connection to the Internet.

The beginning and the end of the update are announced by voice.

THE PEARL is not functional during this phase.



WARNING ! Do not turn off or disconnect THE PEARL from the mains during the update phases! An update may take several minutes.

Note: the reference of the current software version is available via the Cabasse Stream application: tab "Settings" + sub-tab "audio players" + THE PEARL

CLEANING

THE PEARL can be cleaned with a soft cloth, do not use detergent or liquid that can run inside the appliance.

Do not use any solvents, chemicals, or cleaning solutions containing alcohol, ammonia, or abrasives.

FAQ

Check out our answers to frequently asked questions on www.cabasse.com, on the STREAM FAQ page.

AFTER SALES SERVICE

Cabasse has a network of authorized resellers who are at your disposal to ensure the after-sales service of your equipment.

For a list of Cabasse Authorized Dealers, contact us or visit our website www.cabasse.com.

THE PEARL / THE PEARL SUB

Digital inputs	- 1 DLNA input: wired with RJ45 plug or Wi-Fi dual band 2x2 802.11a / b / g / n / ac - 1 Bluetooth 4.2 input - 1 S / PDIF optical input - 1 USB 2.0 input 5V=1A
Analog input	RCA stereo
Power supply	100-240 V ~60/50 Hz, 6A
Consumption	1,400 W
Consumption in Eco mode	2.9 W @ 100-240VAC~50/60Hz
Remote control	Bluetooth low energy
Operating temperature	+5°C à +35°C
Storage temperature	-5°C à +40°C
Moisture rate in use	40% to 70%
Network	10/100Mb Ethernet MAC & PHY Wireless LAN 802.11b/g/n WPS 2.0 Security Digital audio player (DMR with DLNA 1.5)
Audio formats Wifi/RJ45	MP3, AAC, WMA, WAV, AIFF, FLAC, ALAC up to 24 bits/ 192 kHz
Voice control	Google
Music services	Qobuz, Deezer, Napster, Spotify Tidal, Vtuner

Speakers	1 coaxial medium-high BCI 1 x woofer 25 HELD tweeter: 300 W medium 300 W woofer 1 000 W
Active 3-way amplification	Wifi : < 0.2% Bluetooth : < 0.2% Analogic : < 0.2% Optical < 0.2%
Distortion rate plus noise (THD + N on the tape 20-20 000 Hz for a power of 100 mW and more)	
Dimensions (h x l x p)	326 x 327 x 323 mm
Weight	18 kg

FUNCTIONS

	Bluetooth connection	WIFI/ETHER- NET via routeur internet / box internet
Loss less audio broadcast		YES
Access to all audio media from the WIFI network (computer ...)		YES
Multi-room		YES
Broadcast smartphone / tablet audio content	YES	YES
Broadcast audio application (youtube ...) from smartphone / tablet	YES	
Broadcasting from USB media		YES
Internet radio and music services		Qobuz, Deezer, Napster, Spotify, Tidal, Vtuner

THE PEARL AKOYA

Digital inputs	- 1 DLNA input: wired with RJ45 plug or Wi-Fi dual band 2x2 802.11a / b / g / n / ac - 1 Bluetooth 4.2 input - 1 S / PDIF optical input - 1 USB 2.0 input 5V=1A
Analog input	JACK 3,5 mm stéréo
Power supply	100-240 V ~60/50 Hz, 6A
Consumption	1,400 W
Consumption in Eco mode	1,9 -W @ 100-240VAC~50/60Hz
Remote control	Bluetooth low energy
Operating temperature	+5°C à +35°C
Storage temperature	-5°C à +40°C
Moisture rate in use	40% to 70%
Network	10/100Mb Ethernet MAC & PHY Wireless LAN 802.11b/g/n WPS 2.0 Security Digital audio player (DMR with DLNA 1.5)
Audio formats Wifi/RJ45	MP3, AAC, WMA, WAV, AIFF, FLAC, ALAC up to 24 bits/ 192 kHz
Voice control	Google
Music services	Qobuz, Deezer, Napster, Spotify Tidal, Vtuner

Speakers	1 coaxial medium-high BCI 1 x woofer 17 HELD tweeter: 300 W medium 300 W woofer 450 W
Active 3-way amplification	Wifi : < 0.2% Bluetooth : < 0.2% Analogic : < 0.2% Optical < 0.2%
Distortion rate plus noise (THD + N on the tape 20-20 000 Hz for a power of 100 mW and more)	
Dimensions (h x l x p)	220 x 220 x 220 mm
Weight	8 kg

FUNCTIONS

	Bluetooth connection	WIFI/ETHER- NET via routeur internet / box internet
Loss less audio broadcast		YES
Access to all audio media from the WIFI network (computer ...)		YES
Multi-room		YES
Broadcast smartphone / tablet audio content	YES	YES
Broadcast audio application (youtube ...) from smartphone / tablet	YES	
Broadcasting from USB media		YES
Internet radio and music services		Qobuz, Deezer, Napster, Spotify, Tidal, Vtuner

FCC STATEMENT

This equipment has been tested and found to comply with the limits for a Class B digital device, pursuant to Part 15 of the FCC Rules. These limits are designed to provide reasonable protection against harmful interference in a residential installation. This equipment generates uses and can radiate radio frequency energy and, if not installed and used in accordance with the instructions, may cause harmful interference to radio communications. However, there is no guarantee that interference will not occur in a particular installation. If this equipment does cause harmful interference to radio or television reception, which can be determined by turning the equipment off and on, the user is encouraged to try to correct the interference by one or more of the following measures:

- Reorient or relocate the receiving antenna.
- Increase the separation between the equipment and receiver.
- Connect the equipment into an outlet on a circuit different from that to which the receiver is connected.
- Consult the dealer or an experienced radio/TV technician for help.

This device complies with part 15 of the FCC Rules. Operation is subject to the following two conditions : (1) This device may not cause harmful interference, and (2) this device must accept any interference received, including interference that may cause undesired operation.

Changes or modifications not expressly approved by the party responsible for compliance could void the user's authority to operate the equipment. This equipment complies with FCC radiation exposure limits set forth for an uncontrolled environment.

This equipment should be installed and operated with minimum distance 20cm between the radiator & your body

130.com.ua

Cabasse



Cabasse SAS - 210, rue René Descartes - BP 10 - 29280 Plouzané - FRANCE
Tel +33 298 05 88 88 - Fax +33 298 05 88 99

www.cabasse.com

Autogoods "130"