



PHONES

0 (800) 800 130
(050) 462 0 130
(063) 462 0 130
(067) 462 0 130

130
COM.UA

Internet store of
autogoods



SKYPE

km-130

CAR RECEIVERS — Receivers • Media receivers and stations • Native receivers • CD/DVD changers • FM-modulators/USB adapters • Flash memory • Facia plates and adapters • Antennas • Accessories |
CAR AUDIO — Car audio speakers • Amplifiers • Subwoofers • Processors • Crossovers • Headphones • Accessories | TRIP COMPUTERS — Universal computers • Model computers • Accessories |
GPS NAVIGATORS — Portable GPS • Built-in GPS • GPS modules • GPS trackers • Antennas for GPS navigators • Accessories | VIDEO — DVR • TV sets and monitors • Car TV tuners • Cameras • Videomodules
• Transcoders • Car TV antennas • Accessories | SECURITY SYSTEMS — Car alarms • Bike alarms • Mechanical blockers • Immobilizers • Sensors • Accessories | OPTIC AND LIGHT — Xenon • Bixenon • Lamps
• LED • Stroboscopes • Optic and Headlights • Washers • Light, rain sensors • Accessories | PARKTRONICS AND MIRRORS — Rear parktronic • Front parktronic • Combined parktronic • Rear-view mirrors
• Accessories | HEATING AND COOLING — Seat heaters • Mirrors heaters • Screen-wipers heaters • Engine heaters • Auto-refrigerators • Air conditioning units • Accessories | TUNING — Vibro-isolation
• Noise-isolation • Tint films • Accessories | ACCESSORIES — Radar-detectors • Handsfree, Bluetooth • Windowlifters • Compressors • Beeps, loudspeakers • Measuring instruments • Cleaners • Car seats
• Miscellaneous | MOUNTING — Installation kits • Upholstery • Grilles • Tubes • Cable and wire • Tools • Miscellaneous | POWER — Batteries • Converters • Start-charging equipment • Capacitors
• Accessories | MARINE AUDIO AND ELECTRONICS — Marine receivers • Marine audio speakers • Marine subwoofers • Marine amplifiers • Accessories | CAR CARE PRODUCTS — Additives • Washer fluid •
Care accessories • Car polish • Flavors • Adhesives and sealants | LIQUID AND OIL — Motor oil • Transmission oil • Brake fluid • Antifreeze • Technical lubricant



In store "130" you can find and buy almost all necessary goods for your auto in Kyiv and other cities, delivery by ground and postal services. Our experienced consultants will provide you with exhaustive information and help you to choose the very particular thing. We are waiting for you at the address

<https://130.com.ua>

BLAUPUNKT



G-Sensor

Built-in GPS

140°Wide Angle Lens

Support up to 64 GB SDHC



Enjoy it.

BP 3.0 FHD GPS

1131 599 130 001

Autogoods "130"

Before using the product, please read this manual carefully.
The manual is to guide your usage of this product specially.

Caution:

1. Please strictly abide by the relevant national law. This product can not be used for illegal purposes; otherwise take the responsibility by yourself.
2. Please insert the micro SD card in right direction to avoid damage the card or DVR. If DVR writes 'Please Insert SD Card Again', please enter into setting menu and format micro SD card. If it is still the same, please change another micro SD card.
Note: Format micro SD card will delete all files. Please backup the important files before format it.
3. Recommend to use CLASS 6 or above micro SD card. Owing to 64GB micro SD card doesn't have unified standard in the market, not all 64GB micro SD card can be compatible to this DVR. Please test it on DVR before purchase.
4. It is suggested to backup files in micro SD card once a week. This product is not the exclusive storage device, so please backup the important files timely to avoid files is missing.
5. Please check the bracket carefully after installation to avoid damage.
6. The working time of the built-in battery will shrink with the using time increased. If the DVR will not work for a long time, please charge it every two months to avoid over-discharged which shortens lifespan of battery.
7. Please do not take the product under the moist environment. It is not waterproof.
8. Please do not take pictures or movie directly to the sun.
9. Please do not use this product in excessive dust environment in case of the lens and other components to be contaminated and affect the video quality. Please keep lens clean with soft cloth or exclusive dust-free cloth.
10. This product belongs to precision electronic products which can not bear heavy hit and do not use it in high magnetic and electronic working environment.
11. Please cut off power if there is any abnormal phenomenon to avoid short circuit.
12. **Working temperature for this device is -10°C-50°C and storage temperature is -20°C -70°C. Continuous exposure to direct sunlight for an extended period of time, may cause the device to malfunction, color change, housing and image distortion, especially in locked cars where cabin temperature exceeds 70°C.**

1. Structure

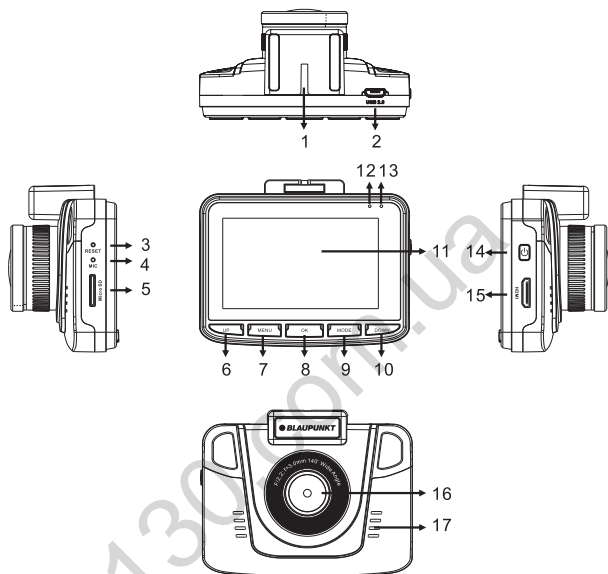







- | | | |
|-----------------------|-----------------------------|---------------------------|
| 1. Bracket Hole | 7. MENU Key | 13. Power Indicator Light |
| 2. USB Port | 8. OK Key | 14. ON/OFF Key |
| 3. RESET | 9. MODE Key | 15. HDMI Output |
| 4. Microphone | 10. DOWN Key | 16. Lens |
| 5. Micro SD Card Slot | 11. LCD | 17. Speaker |
| 6. UP Key | 12. Working Indicator Light | |

2. Features

1. Support multiple video resolutions, such as 1080P, 720P and etc with superior video and image quality;
2. Support 60fps for high-speed recording;
3. High definition CMOS lens module with wide viewing angle;
4. Built-in microphone/speaker;
5. With Voice/Mute Recording shortcut Key;
6. With LCD OFF shortcut Key;
7. Support high capacity micro SD card;
8. Support seamless loop recording and as recording as charging;
9. Automatically take video when car engines on and turn off when car engines off;
- 10.Support motion detection;
- 11.Support SOS and G-Sensor to prevent important files from being overwritten;
- 12.Support HDMI output;
- 13.Support parking monitoring function;
- 14.Support GPS tracking function;
- 15.Support driver ID;
- 16.Support multi-language.

3. Key Definition and Function

Picture	Definition	Function
	ON/OFF	Long press to power on/off.
	UP	In Movie or standby mode, short press UP key to turn on/off voice recording; In Still Capture mode, short press UP key to zoom in; In setting mode and preview mode, short press UP key to select; In video playing or pause status, short press UP key to fast backward.
	MENU	In standby mode, short press MENU key to enter into setting mode and press it again to quit when setting is completed; In recording, short press MENU key to activate SOS function, and press it again to deactivate.
	OK	In Movie mode, short press OK key to pause or record; In Still Capture mode, short press OK key to take photo; In Playback mode, short press OK key to play video/pause; In setting mode, short press OK key to confirm.
	MODE	In standby mode, short press MODE key to switch Movie/Still Capture/Playback mode; In setting mode, short press MODE key to switch different mode menu; In playback mode, short press MODE key to back to preview mode.
	DOWN	In Movie mode, short press DOWN key to turn on/off LCD OFF; In Still Capture mode, short press DOWN key to zoom out; In setting mode and preview mode short press DOWN key to select; In video playing or pause status, short press DOWN key to fast forward.
•	RESET	Pock it when DVR software crashes down.

4. Indicator Light Definition

Indicator Light	Definition
Red	Long steady on means DVR is charging; After full charge, red light is off.
Green	Long steady on means DVR is in standby mode; flicking means DVR is recording.

5. Function

I.ON/OFF

(1)Power on

A. In off state, long press ON/OFF key for 3 seconds to power on and start recording automatically with green light flashing.

B. DVR is connecting with car charger to start recording.

Note: If there is a pop-up window to show 'SD card is not inserted', please insert micro SD card before use.

(2)Power OFF

A. In working status, long press ON/OFF key for 3 seconds to power off.

B. In working status, DVR will automatically save the current file and power off automatically when unplug the car charger.

C. In low battery status, DVR will automatically save the current file and power off automatically.

II.Battery Charging





(1)Two ways to charge

A.with USB cable

B.with car charger(suggested)



(2)Battery Status Definition

	Full		Medium
	Low		Empty

III.Micro SD Card Insertion

Straightly insert micro SD card into the slot as indicated below until hearing 'click' sound.

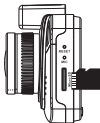

Pop up Micro SD Card: Push forward micro SD card first and then take it out(it is suggested to do it with DVR off)

IV.Movie Mode

Power on DVR to enter into movie mode directly with green light flashing. Short press OK key to saved the current file and stop recording. The DVR enters into standby mode with green indicator light steady on. In standby mode, short press OK key to restart recording.



V.Still Capture Mode

In standby mode, short press MODE key to enter into still capture mode and press OK key to take photos.

In still capture mode, short press UP or DOWN key to zoom in or zoom out (Max. x 4).



VI. Playback and Preview Mode

A. In standby mode, short press MODE key twice to enter into preview mode. Short press UP or DOWN key to select the video file and then press OK key to play. In video playing status, short press UP key to fast reverse and DOWN key to fast forward (max. x8). Press OK key to pause in video playing status. Short press MODE key to stop playing and go back to preview mode.

In preview mode, short press MODE key to preview photos. Short press UP or DOWN key to select the photos. OK key is pressed for full-screen preview and press UP or DOWN key to go to next or previous photo.

B. In preview mode, short press MENU key to enter into playback mode to adjust volume, delete or protect files. Short press UP or DOWN key to select 'Volume', 'Delete' or 'Protect', and press OK key to enter into submenu. Short press UP or DOWN key to select and OK key for confirmation. Then short press MENU key to quit and go back to preview mode.

Movie Preview

Current Movie

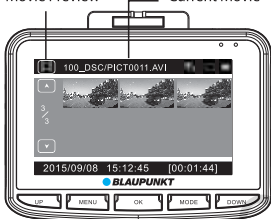
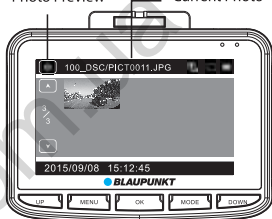

Photo Preview

Current Photo



VII. G-SENSOR

In movie mode, the car brakes suddenly or is hit heavily, G-sensor will be activated to lock the current video clip from being overwritten. Three-step sensitivity (high, medium, low) are to cater for different car owners and can be set in 'Protect Level' in General Settings.

Note: All locked files will be saved from being overwritten and in Emergency folder in the menu.

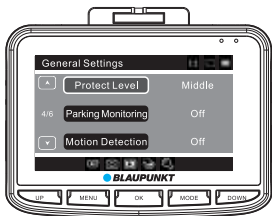

G-sensor Sensitivity

VIII.SOS

In movie mode, short press MENU key to lock the current file manually in case of the important file is overwritten in loop recording. Press MENU key again to unlock the current file.

Note: If SOS is activated to work, the current video will be saved from being overwritten when the card's full. Please check the video in Emergency folder in the menu.



SOS ON

IX.Voice/Mute Recording

In standby or movie mode, short press UP shortcut key to be voice recording or mute recording, or press MENU key to go to Movie Mode to set up.

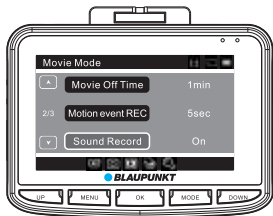

X. Parking Monitoring

Enter into General Setting to turn on parking monitoring function and there are three-step settings(High, Middle and Low).Middle is suggested when parking monitoring turning on. When parking monitoring is at work, DVR will show 'P' on the top left.

A. After the car engines off, DVR will be automatically power off too, but once DVR detects vibration, it will power on automatically and record 10 seconds and then turn off again. If other functions are working at same time, parking monitoring is top priority.

B. When parking monitoring turning on while driving, DVR will power on automatically once it detects vibration and record circlely with the first file locked.

Note: All locked files will be saved from being overwritten and in Emergency folder in the menu.

Go to General Setting to turn off parking monitoring and 'P' will disappear.



XI. GPS Tracking

This DVR is built in GPS module and can record the driving track, longitude and latitude information as well as real-time speed, which are very important driving information.

When DVR is on, it will position automatically. There is GPS status icon on the top left. When it turns green, GPS positions successfully; when it is red, GPS is still in positioning status. Please go to GPS status in General Settings to view detailed GPS information.

Please select correct time zone before use this function. Please enter into General Settings to set it up. After GPS positions successfully, GPS satellite time will synchronize to show on the screen.

Note: Please position outdoor. GPS is hard to position indoor because of weak GPS signal. Driving track can be reviewed with exclusive GPS player. Please refer to 'Part 7 BP GPS VP 3.0 Instruction'.

GPS Status Icon

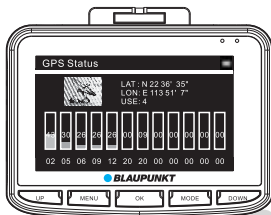
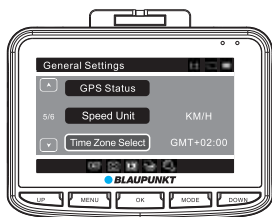
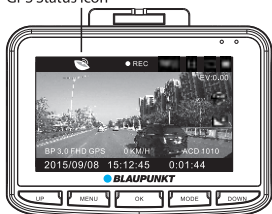

XII.Driver ID

In standby mode, short press MENU key to enter into settings, and press MODE key to go to General Settings. Select 'Driver ID Settings' and press OK key to input numbers. There are total 9 characters available and press UP/DOWN key to select '0-9', 'A-Z', "." and space. After confirmation, press OK key to go to next character or back to General Settings.

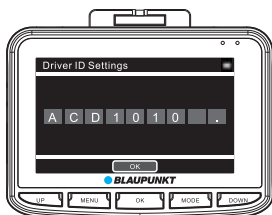
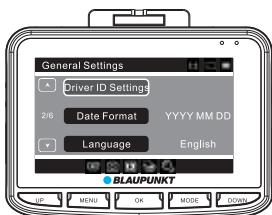

XIII.Motion Detection

In standby mode, press MENU key to enter into setting in Movie Mode and select 'Motion Event REC' to choose recording time of every movie clip in motion detection.

After confirmation, press OK key to quit 'Motion Event REC' and then press MODE key to go to General Settings. Select 'Motion detection' and press OK key to select the sensitivity. Here are 3 steps sensitivity, 'High', 'Middle' and 'Low'. Middle is suggested when motion detection turning on. Press OK key to confirm and then press MENU key to quit. DVR starts to automatically countdown from 9 second to activate motion detection. If there is any movement detected, DVR will record automatically in preset recording time of movie clip. In motion detection mode, press any key to quit and go back to standby mode. Press MODE key 4 times can go back to mode detection mode again. To turn off motion detection, please go to General Settings.

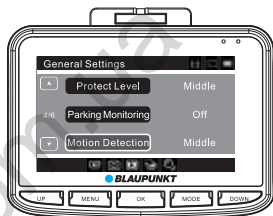

Motion Detection Icon

XIV.Video and Photo Management

Please go to General Settings to select USB Function before connecting with the computer via USB cable in the package. Here are two options, 'MSDC' and 'PC Cam'.

- 1)MSDC is for video and photo backup and delete.
- 2)PC Cam is for video call.

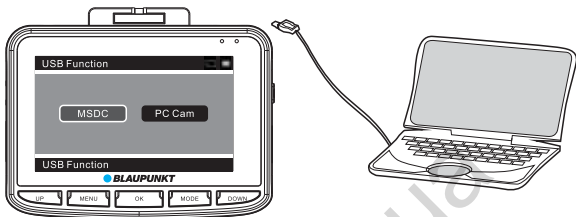

6. System setting Table

	Mode	Category	Sub-Category	Remark
Setting Menu	Movie Mode	Resolution	1920X1080 30fps 1280x720 30fps 1280x720 60fps 640x480 30fps	Default: 1920X1080 30fps
		Movie Quality	Super Fine/Fine	Default: Super Fine
		Movie Clip Time	Off/1min/3min/5min	Default:1min
		Movie Off Time	0min/5sec/30sec/1min/3min	Default: 5sec
		Motion event REC	5sec/10sec/30sec/1min	Default:1min
		Sound Record	On/Off	Default:On
		Exposure	-2~+2	Default:0
	Still Capture	Still Image Size	12M/8M/5M/3M/2M/1.2M/VGA	Default:12M
		Still Quality	Super Fine/Fine	Default: Super Fine
		Exposure	-2~+2	Default:0
		White Balance	Auto/Daylight/Cloudy/Fluoresc./ Fluoresc.1/Fluoresc.2/Incandesc.	Default: Auto
		ISO Sensitivity	Auto/ISO100/ISO200/ISO400	Default: Auto
		Color	Natural/Vivid/Pale	Default: Natural
	Playback	Volume	1~10	Default: 5
		Delete	Delete One/Delete All	
		Protect	Protect One/Protect All/Unprotect One/Unprotect All	
		Video Type	Normal/Emergency	
	Media Tool	Format SD card	YES/NO	
		SD Card INFO	Time/Photo Left	
	General Settings	Beep	On/Off	
		Power Off	Never/1min/5min	Default:Never
		Clock Settings	YYYY MM DD HH MM SS	
		Driver ID Settings	0~9/A~Z"/:/space	
		Date Format	None/YYYY MM DD/MM DD YYYY/ DD MM YYYY	Default: DD MM YYYY

Setting Menu	General Settings	Language	English/Français/Deutsch/Italiano/ Polski/Português/Español/ Nederlands/Suomi	Default: English
		Frequency	50HZ/60HZ	
		USB Function	MSDC/PC Cam	Default: MSDC
		LCD Power Save	Off/1min/3min	Default:Off
		Protect Level	Off/High/Middle/Low	Default: Middle
		Parking Monitoring	Off/High/Middle/Low	Default: Off
		Motion Detection	Off/Low/Middle/High	Default: Off
		GPS Status	GPS Positioning Information	
		Speed Unit	KM/H MPH	
		Daylight Saving Time	On/Off	Default: Off
		Time Zone Select	GMT-12:00/GMT-11:00/GMT-10:00/ GMT-09:00/GMT-08:00/GMT-07:00/ GMT-06:00/GMT-05:00/GMT-04:00/ GMT-03:30/GMT-03:00/GMT-02:00/ GMT-01:00/GMT/GMT+01:00/ GMT+02:00/GMT+03:00/ GMT+03:30/GMT+04:00/ GMT+04:30/GMT+05:00/ GMT+05:30/GMT+05:45/ GMT+06:00/GMT+06:30/ GMT+07:00/GMT+08:00/ GMT+09:00/GMT+09:30/ GMT+10:00/GMT+11:00/ GMT+12:00/GMT+13:00	
		Reset Setup	YES/NO	
FW Version	Current Software Version			

7. BP GPS VP 3.0 Instruction

I. Installation

- ① Install GPS player-"BP GPS VP 3.0" on MAC OS
Double click 'BP GPS VP 3.0.zip' to install automatically.
- ② Install GPS player-"BP GPS VP 3.0" on WINDOWS OS
Copy 'BP GPS VP 3.0.zip' to desktop and unzip to 'BP GPS VP 3.0'.

II. How to Start

- ① In MAC OS, double click "BP GPS VP 3.0" to start.
- ② In WINDOWS OS, double click 'BP GPS VP 3.0.exe' to start.

III. User Interface Definition

Here's user interface of BP GPS VP 3.0 WINDOWS version. MAC version is almost same.



- ① Driving Speed: show real-time driving speed; double click to switch KM/H and MPH
- ② Video Play Window: double click any place in this window to view in full screen mode; double click again, it will be back to the current mode
- ③ Scroll Bar: show the current point of the video; drag it to move forward or backward
- ④ Real-time G-sensor Information
- ⑤ Video Group: Videos taken in sequence will be one group
- ⑥ Select Video to Play
- ⑦ Image Capture: capture the current point of the video
- ⑧ Save to: select one video from Video List to save it into one folder on PC
- ⑨ Delete: select one video from Video List to delete
- ⑩ Settings: select language
- ⑪ Fast Backward: 0.9/0.8/0.7/0.6/0.5/0.4/0.3 times
- ⑫ Stop
- ⑬ Play/Pause
- ⑭ Fast Forward: 1.2/1.4/1.6/1.8/2.0/2.4/2.8/3.2/3.6/4.0 times
- ⑮ Volume
- ⑯ Autoplay: click to play next video automatically after finish; click again to turn it off
- ⑰ Save to KML Format: select one video from Video List to save it in KML format
- ⑱ Unlock Video: select one locked video from Video List to unlock it
- ⑲ Video List: show video size, length and etc.; double click the video to play
- ⑳ Map Window: show real-time movement track of vehicle with internet
- ㉑ MapType: plane map/satellite map/3D map
- ㉒ Map Scroll Bar: drag it to zoom in and out
- ㉓ Direction Navigation

Note: all windows can be dragged to adjust

Please visit official website www.blaupunkt.com and www.blaupunkt.de to download the newest BP GPS VP 3.0 if there is any abnormal work.

8. Product Specification

Specification may change due to upgrade without prior notice. Please take the objects as standard.

LCD Size	2.7" HD TFT screen (16:9)
CMOS Sensor	OV2710
Viewing Angle	140° diagonal ultra wide viewing angle
Video Resolution	1920X1080 30fps/1280x720 30fps/1280x720 60fps/640x480 30fps
Image Resolution	12M/8M/5M/3M/2M/1.2M/VGA
Minimum Illumination	1 LUX
Video Format	AVI/H.264
Image Format	JPG
Memory Card	Micro SD Card
Memory Card Capacity	Max. 64GB
Digital zoom	X4
Frequency	50HZ/60HZ
Output	HDMI
Power Port	USB 5V 1000mA
Battery Capacity	600mAH
Microphone/Speaker	Built-in
Loop Recording	Off/1min/3min/5min
LCD Off	Support
Parking Monitoring	Support
G-Sensor&SOS	Support
Motion Detection	Support
Parking Monitoring	Support
GPS Tracking	Support
Driver ID	Support
Language	English/Français/Deutsch/Italiano/Polski/Português/Español/ Nederlands/Suomi
DVR N.W.	105g
DVR Size	81.4(L)X64.7(W)X41.0(H)mm

9. Cabling Instruction

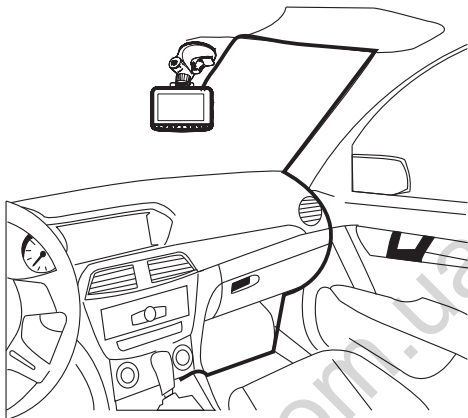

10. Accessories

The following accessories are for reference only. Please take objects as standard. The right to change without prior notice is reserved.

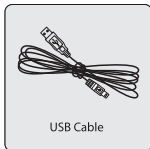
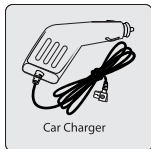
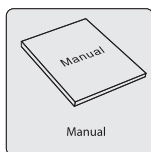
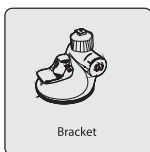

 **BLAUPUNKT**

Enjoy it.

Competence Center Car Multimedia
Evo-Sales GmbH
Robert-Henseling-Straße 11
31789 Hameln
Deutschland
www.blaupunkt.com



 After the manual, if any change, we will not Notice!

Autogoods "130"