



PHONES

0 (800) 800 130
(050) 462 0 130
(063) 462 0 130
(067) 462 0 130

130
COM.UA

Internet store of
autogoods



SKYPE

km-130

CAR RECEIVERS — Receivers • Media receivers and stations • Native receivers • CD/DVD changers • FM-modulators/USB adapters • Flash memory • Facia plates and adapters • Antennas • Accessories |
CAR AUDIO — Car audio speakers • Amplifiers • Subwoofers • Processors • Crossovers • Headphones • Accessories | TRIP COMPUTERS — Universal computers • Model computers • Accessories |
GPS NAVIGATORS — Portable GPS • Built-in GPS • GPS modules • GPS trackers • Antennas for GPS navigators • Accessories | VIDEO — DVR • TV sets and monitors • Car TV tuners • Cameras • Videomodules
• Transcoders • Car TV antennas • Accessories | SECURITY SYSTEMS — Car alarms • Bike alarms • Mechanical blockers • Immobilizers • Sensors • Accessories | OPTIC AND LIGHT — Xenon • Bixenon • Lamps
• LED • Stroboscopes • Optic and Headlights • Washers • Light, rain sensors • Accessories | PARKTRONICS AND MIRRORS — Rear parktronic • Front parktronic • Combined parktronic • Rear-view mirrors
• Accessories | HEATING AND COOLING — Seat heaters • Mirrors heaters • Screen-wipers heaters • Engine heaters • Auto-refrigerators • Air conditioning units • Accessories | TUNING — Vibro-isolation
• Noise-isolation • Tint films • Accessories | ACCESSORIES — Radar-detectors • Handsfree, Bluetooth • Windowlifters • Compressors • Beeps, loudspeakers • Measuring instruments • Cleaners • Car seats
• Miscellaneous | MOUNTING — Installation kits • Upholstery • Grilles • Tubes • Cable and wire • Tools • Miscellaneous | POWER — Batteries • Converters • Start-charging equipment • Capacitors
• Accessories | MARINE AUDIO AND ELECTRONICS — Marine receivers • Marine audio speakers • Marine subwoofers • Marine amplifiers • Accessories | CAR CARE PRODUCTS — Additives • Washer fluid •
Care accessories • Car polish • Flavors • Adhesives and sealants | LIQUID AND OIL — Motor oil • Transmission oil • Brake fluid • Antifreeze • Technical lubricant



In store "130" you can find and buy almost all necessary goods for your auto in Kyiv and other cities, delivery by ground and postal services. Our experienced consultants will provide you with exhaustive information and help you to chose the very particular thing. We are waiting for you at the address

<https://130.com.ua>



BALTIC CAR EQUIPMENT

FMS500 ONE

GPS/GLONASS VEHICLE TRACKER



User manual
Version FMS500

Contents

1. FMS500 ONE general device information	3
1.1. Safety and legal information	3
1.2. Description	3
1.3. Package	3
1.4. Technical specifications	4
1.5. Physical properties	5
1.6. Pinout & diagnostic LED	7
1.6.1. Pinout	7
1.6.2. Diagnostic LED	8
1.7. Installation	9
1.8. Configuration	9
1.9. Support	9
1.10. Document versions	9
2. Annex 1. Installation instructions	10
3. Annex 2. Configuration manual	15
3.1. BCE Device Configuration Manager	15
3.1.1. Users and Dealers	15
3.1.2. Devices and Retranslators	17
3.1.3. Firmware	23
3.1.4. GSM operator groups	24
3.1.5. XML settings	25
3.1.6. Device logic	26
3.1.7. Function signals	29
3.1.8. Functions	30
3.1.9. Configuration examples	35
3.1.10. Geozones and Geozone groups	38
3.1.11. Dallas ID lists	39
3.1.12. Dataset7_Mask1 description table	40
3.1.13. Dataset7_Mask2 description table. FMS-CAN (J1939)	41
3.1.14. Dataset7_Mask3 description table	43
3.1.15. DataSet7_Mask4 Description table	44

1. FMS500 ONE general device information

1.1. Safety and legal information



Do not disassemble the device.

May interfere operation of adjacent electronic devices.

Device may be damaged by water and high humidity.

Installed by qualified professionals only.

Copyright © Baltic Car Equipment, Ltd. All rights reserved. Reproduction, transfer, distribution or storage of part or all of the contents in this document in any form without prior written permission of Baltic Car Equipment is strictly prohibited.

1.2. Description

FMS500 ONE is a device with GPS/Glonass and GSM connectivity, designed for object tracking. It is able to acquire information on object location, speed, direction, etc. and transfer the data via GSM network. Digital input of the device may be used to connect different external sensors/devices. Output of the device may be used to control external equipment remotely.

Flexible configuration allows users/dealers to adjust the device to meet their specific requirements. All device settings and firmwares are updated remotely via GPRS. It is possible to create setting templates for groups of vehicles, use mass updates and create unique device operation logic, fulfilling requirements of most cases on the market.

1.3. Package

FMS500 ONE is shipped to a customer in a cardboard box and contains all required components for operation, except a SIM card. Package contents:

1. FMS500 ONE device (control unit)
2. Wires + fuse

Note. SIM card is not included, but is necessary to operate the device. Contact your local GSM operator to purchase a SIM card. BCE recommends an M2M SIM card for best performance and reliability.

1.4. Technical specifications

Table 1. FMS500 ONE technical specifications

General	
Inputs	1x digital (ON/OFF mode)
Outputs	1x digital, (-)
Power supply	8 – 31V Protection from impulses up to 150V Consumption at 12V: active: <60mA, sleep: <8 mA Registration of power cut-off to device event log Internal battery 700 mAh (optional)
Internal memory	4 MB, up to 150.000 entries
Accelerometer	3 axis digital accelerometer
Internal odometer	+
Operational temperature range	from -40 to +85 C°
Dimensions	68x91x19 mm
Weight	Tracker – 62 g, set – 141 g
GSM	Internal antenna
GSM/GPRS class	10 (up to 85,6 kbit), class B
Detection of GSM jamming	+
GPS / GLONASS	Internal antenna
Sensitivity	-162 dBm
Acquisition	Cold <30 s, hot 1 s. A-GPS support

1.5. Physical properties

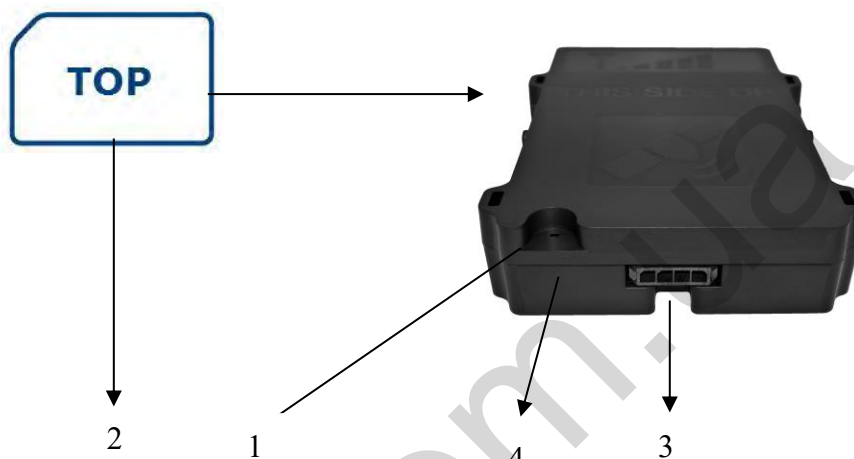

Fig. 1. FMS500 ONE front view.

Note. To insert a SIM card, open the box by lifting plastic holders from both sides.

Table 1. FMS500 ONE components

No.	Short description
1	Device and GPS status LED
2	SIM card
3	Socket 1x4 pins
4	USB interface



Fig. 2. FMS500 ONE dimensions, mm

1.6. Pinout & diagnostic LED

1.6.1. Pinout

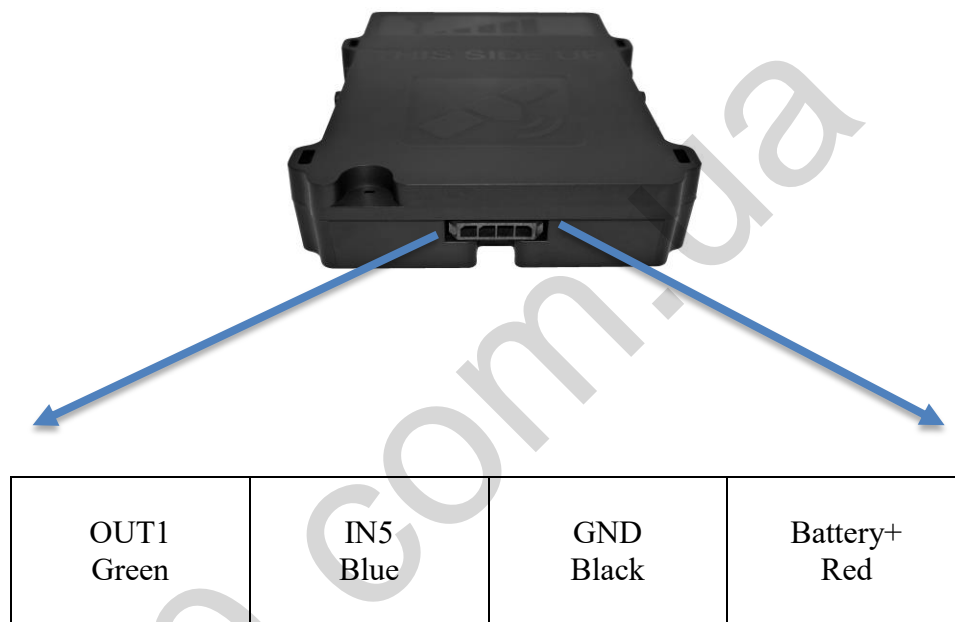

Fig. 3. FMS500 ONE pinout and cable colors.

Electrical properties of the device are shown in Table 2.

Table 2. FMS500 ONE electrical properties

OUT1 (-)	1.7A
Power supply, min start up voltage	10V
Power supply, min operating voltage after start up	8V
Power supply, stage1	30V
Clamping voltage clamping type	31V varistor
IN5 voltage threshold	4.7V, +/-3%

1.6.2. Diagnostic LED

FMS500 ONE has an indication LED – for GPS and GSM modem status. LED starts flashing only if IN5 digital input is connected to battery +.

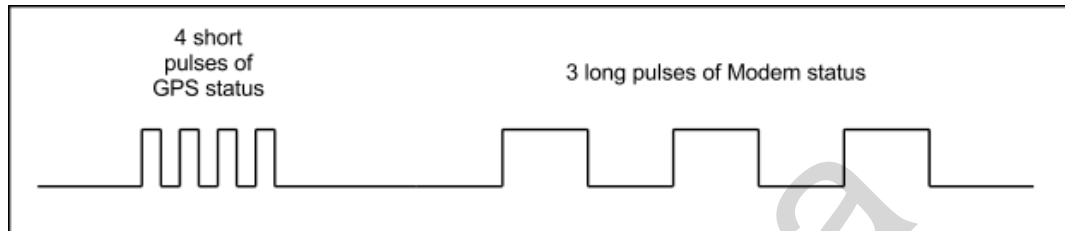

Fig 4. LED flash signal. Example.

Table 3. Short flash meaning. GPS status.

Short flashes count	Meaning
1	No GPS signal
2	Poor precision. HDOP>1.5
3	3 satellites locked. HDOP<1.5
...	...
12	12 satellites locked. HDOP<1.5

Table 4. Long flash meaning. GSM modem status.

Long flashes count	Meaning
1	Modem connected to server, Modem connected to Internet, Modem GPRS registered, Modem GSM registered, Modem SIM card ok, Modem turned on
2	Modem connected to Internet, Modem GPRS registered, Modem GSM registered, Modem SIM card ok, Modem turned on
3	Modem GPRS registered, Modem GSM registered, Modem SIM card ok, Modem turned on
4	Modem GSM registered, Modem SIM card ok, Modem turned on
5	Modem SIM card ok, Modem turned on
6	Modem turned on
7	Device started

1.7. Installation

FMS500 ONE is installed where risk of mechanical damage, high humidity and extreme heat is low. Device is mounted stable to vehicle body, therefore ensuring correct operation of the internal accelerometer. Complete installation manual is available as Annex 1.

1.8. Configuration

FMS500 ONE is to be configured via a configuration server, where dealers/users can adjust operation of their devices to fulfill specific requirements. Configuration manual is available as Annex 2.

1.9. Support

FMS500 ONE is built to be a reliable, stable and easy to install device. Please read and follow provided installation and operating instructions carefully. However, if you encounter difficulties while installing or using this product, technical support is available and may be reached by e-mail support@bce.lt or tech_support@bce.lt.

1.10. Document versions

Table 5. Document versions

Version	Date	Changes
1.0	2017.06.21	Document created.

2. Annex 1. Installation instructions

List of suitable vehicles

FMS500 ONE is intended for all vehicles with petrol or diesel engines, where negative pole is body of the vehicle. Device must be connected to the vehicle battery, ensuring constant power supply even if the engine is not working and ignition is off.

When active, FMS500 ONE uses a small amount of direct current (DC) – less than 60 mA at 12V. It can be mounted in 12 V or 24 V vehicles.

Standby mode

This is a mode of the device when the vehicle ignition is turned off, and there are no active alarms. In this mode, the GPS receiver is switched off in the control unit (in order to reduce power consumption) and communication with the server intervals are increased. Device switches to active mode if programmed trigger is detected (for example accelerometer signal).

Active mode

This is a mode when ignition is on, or when any programmed trigger is active. In this mode, GPS receiver is enabled in the central unit and connection with the server is carried out more frequently. After ignition is switched off, the central unit remains active for another 10 minutes.

- Free configuration of data dispatch frequency is possible.
- During the data transfer (GSM / GPRS communications), short-term increase in current consumption of up to 100 mA is possible.
- Power-line (primary or back up battery) has to be connected via 1A fuses.

Basic instructions before beginning the installation

Quality of connections, location of the device and its antennas, etc. play a significant role on accurate operation of the system. Below are some tips and rules for correct installation to attain professional quality and ensure maximum efficiency of the device.

Location for central unit installation

Central unit should be hidden in a difficult to access location to prevent unwanted interference by unauthorized persons. Small size and flat body makes it easy to do and allows use of small gaps for installation.

The device must be fixed in the vehicle in position where connectors are oriented to the ground. This will prevent moisture condensation inside the unit.

Electrical connections

Control unit must be powered by continuous voltage. When starting the engine, voltage cannot fall below 10 V. It is desirable that power supply for the device is connected to the factory cable led from battery terminals. This allows operation of the unit despite of failure of any vehicle fuses.

Mechanical connections

To highest possible extent, cavities in the vehicle should be used for wiring. If you need to make a new hole, it must be protected against corrosion appropriately!

Wiring connection must be made by brazing, and not merely mechanical wire connection. It is especially important to protect the connections with insulation for high-resistance atmospheric conditions. Do not use insulation with unknown resistance parameters.

Efforts should be made to tie the new wiring into the car's standard wiring bales.

Installation of central unit

Steps to install central unit:

- Insert a SIM card into the device;
- Install central unit;
- Connect power supply;
- Connect array;
- Connect ignition wire to a digital input (usually IN5);
- Connect other devices (optional).

SIM card

SIM card must be inserted into the device before starting installation. The device must be turned off when inserting SIM card. Before inserting the SIM card, make sure you have activated GPRS connection, the card's PIN code must be disabled.

If the vehicle is travelling to foreign countries, roaming service must be activated for the SIM card. The SIM card and phone number must be checked and clearly marked on the installation certificate of the device.

IMPORTANT! Before inserting a SIM card, do not forget to disable PIN code. Otherwise, the device will not work, and the SIM card will be blocked.

GPS antenna

GPS antenna is the main element responsible for vehicle positioning accuracy and quality. FMS500 ONE units are equipped with internal GPS antenna. To ensure best possible GPS signal reception and evaluating GPS signal character, there are strict requirements for correct installation of the tracking unit:

- The accordingly marked side of the device must be invariably directed to the sky. The device must be oriented horizontally (not at an angle) and oriented with the corresponding side towards the top.
- The device should not be covered with metal sheet or reinforced glass. In vehicles with standard glass (e.g., without built-in heating elements).
- Fixing of the device must be stable and immobile, providing for the installation durability. It is necessary to take into account events, which may lead to loss of device stability, to select the mounting location and methods that would allow to avoid these factors.

GSM antenna

GSM antenna is responsible for transfer of collected data and connection with central server. Good antenna's performance is the key element in obtaining information from the device. FMS500 ONE trackers are equipped with internal GSM antenna.

GSM antenna does not require orientation to open sky; however you should be aware that metal elements weaken the GSM signal. It is also necessary to take into account the emission of the antenna's high frequency radio waves, which may interfere with operation of electronic devices.

Device installation

Central unit is only mounted inside of the vehicle, it cannot be installed in the engine chamber, next to the cabin, or in the area of exposure to direct external conditions. Central unit must be hidden (for example, under the upholstery), as well as protected from moisture exposure. Device must be fastened in a stable position to avoid random twitches and displacements (suspension on cables is strictly prohibited). Central unit must be mounted horizontally. Precise orientation is of particular importance to flawless operation of the system, since the device is equipped with acceleration sensors recording the data which directly affects the results obtained. Pinout and cable colors are shown in figure 1.

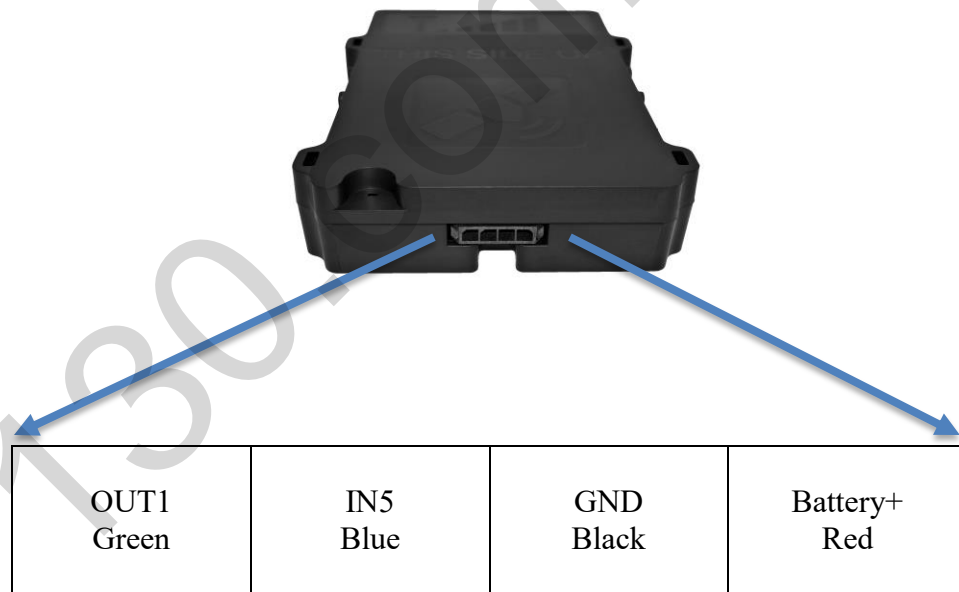

Annex 1. Fig. 1. FMS500 ONE pinout.

Power supply

Power supply of central unit has to be connected directly from the vehicle's battery, using 1A fuse.

Ground wire

Ground wire should be connected to the vehicle body. A reliable electrical contact with the body must be ensured, wire has to be bolted.

Ignition input (combustion lock status)

Connect a wire of the vehicle where voltage is present only when ignition is activated to IN5.

130.com.ua

3. Annex 2. Configuration manual

3.1. BCE Device Configuration Manager

BCE Configuration Manager is a web based service for adding new devices, changing device settings, firmware, operators, creating retranslations and more. This service allows you to configure and manage your devices remotely.

You may access it at www.fmset.eu if you have an account. Once you log in to the website, Home screen will appear. In this page you can find useful information about Baltic Car Equipment products:

- User manuals;
- Hardware revision code description and pinout;
- Event meaning list;
- Status LED flash meaning;
- Master SIM card;
- Warranty application form.

BCE configuration manager includes the following tabs:

1. Home;
2. Users;
3. Dealers;
4. Devices;
5. Firmwares;
6. GSM operator groups;
7. XML settings;
8. Geozones;
9. Geozones groups;
10. Dallas ID groups;
11. Device logs;
12. Audit info (for administrators only).

3.1.1. Users and Dealers

Each dealer has a user account and can control all his devices via BCE Device Configuration Manager.

You may create new user accounts. The fields which are marked red must be filled (user ID, password, role), other fields are optional (see Picture 1). A dealer must be assigned to every user. It should be created in dealers tab first.

User

User ID This field is required.

Password This field is required.

Repeat password This field is required.

Name

Surname

E-mail

Role User with dealer role must be assigned to dealer.

Dealer

Simple configuration

Picture 1. User creation window

Dealer is necessary for proper device management in the configuration system. Your dealer and user will be created by Baltic Car Equipment team, when you start using configuration manager. If the dealer has a network of dealers, he can control the sub-dealers and their devices. While creating a dealer, your dealers name will be filled automatically in “parent dealer” field. Quantity of sub dealers is not limited.

Dealer

Dealer settings | Assign firmwares

Name This field is required.

Notes

Email addresses

Parent dealer

Picture 2. Dealer creation window

After creating the devices you can change the dealer for one or a group of them. In the “Devices” tab select the devices you want to change the dealer for, click “Transfer selected devices”, select the dealer you need and click “Transfer”.

3.1.2. Devices and Retranslators

In the “Devices” tab you can change main device parameters and see it’s status.

First step is creating new device. Select hardware version (C version) and press next.

Device settings window will appear (Picture 4). Fill in the required fields:

1. IMEI number. It is printed on the device.
2. Operator group. It is optional. Detailed description in chapter 6.
3. Geozone group. Optional. Detailed description in chapter 6.
4. Dallas ID list. Optional. Detailed description in chapter 6.
5. XML settings. Will be explained with details in chapter 6.
6. Dealer. If You have sub-dealers, you can assign devices to particular dealer.
7. Notes. Optional, usually hardware version filled.
8. Preferred firmware. Will be explained with details in chapter 6.
9. Phone number. Telephone number of the SIM card inserted in the device.
10. Network settings.
 - 10.1. Server. Host and port filled in automatically. Do not change it.
 - 10.2. Direct Transfer. Host and port of Monitoring platform.
 - 10.3. APN name. Must be provided by your operator.
 - 10.4. APN user. Must be provided by your operator. Often left “blank”.
 - 10.5. APN password. Must be provided by your operator. Often left “blank”.
 - 10.6. Service1 number. Telephone number to which device could send a message with its status.
 - 10.7. Service2 number. Telephone number to which device could send a message with its status.
8. 1st custom value. Additional settings field.
9. 2nd custom value. Additional settings field.
10. Warranty. Field must be filled when device is sent for warranty check.
11. Info. Useful information about device, GSM, GPS versions and creation date.

Note: If you which create few units, which are the same type (FMS500 ONE) and will use the same settings, you can use function “Create multiple devices”.

Device

Select hardware version or template device and press "Next" button.

Hardware version

Template devices

Picture 3. New device

Device settings | Retranslators | Public link | Hardware info | Tachograph | CAN

Main

Create multiple devices

IMEI This field is required.

Hardware version

Operator group

Geozone group

Dallas ID list

XML settings

Dealer This field is required.

Notes

Password

Firmware

Preferred firmware This field is required.

Current firmware

Update only at home

Keep current firmware

SIM card

Phone number

ICCID

IMSI

Additional settings

1st custom value

2nd custom value

Template

Template name

Warranty

Sent

Date

Network

Use server settings

Server

Host

Port

Main protocol

Direct transfer

Host

Port

Protocol

APN

Name This field is required.

User

Password

SMS numbers

Service1 This field is required.

Service2 This field is required.

Info

Version

GPS firmware

Modem firmware

Created in system

First activity

Picture 4. Device settings

If you are creating many devices with same parameters, you can save one device as a template (put a tick in a checkbox “Template”, Picture 4). Choose it from the “Template devices” (Picture 3), it will be in a drop box list sorted by IMEI.

Once device is created you can easily find it by entering one or few search parameters.

There are few more useful functions in devices tab. When you click “Search” button in the “Devices” tab, you will generate a list of devices, on the left side of the IMEI you will see two symbols and a checkbox (Picture 5.)



Picture 5.

The checkbox is used for device transfer to another dealer (sub-dealer), or massive device update. Means you can update many devices at once and update more than one parameter at a time (Picture6.). All update parameters are described in Table 6.

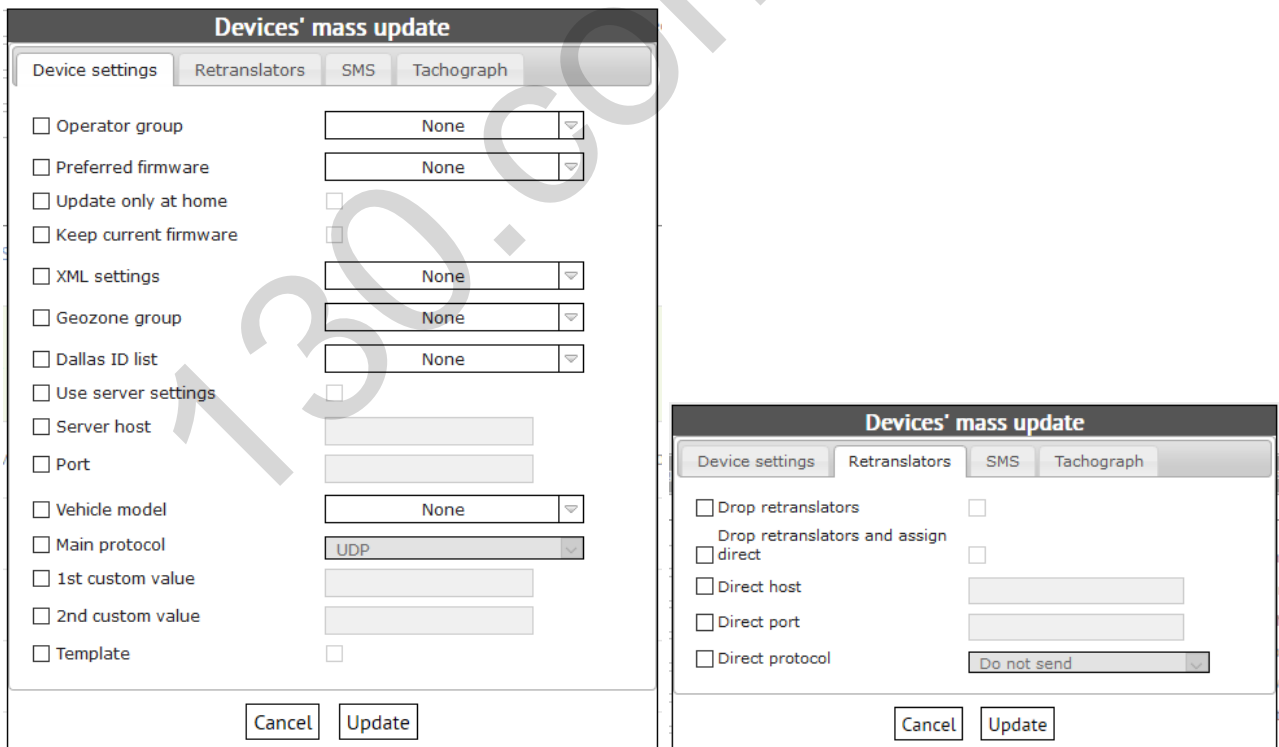

Picture 6. Mass update. “Device Settings” and “Retranslators” tabs.

Table 6. Devices mass update

Parameter	Description
Operator group	Assigns operator group
Preferred firmware	Assigns firmware
Update only at home	If checkbox is marked, device will update firmware and settings only while connected to a home network
Keep current firmware	If checkbox is marked, when device connects to server for the first time, it will keep firmware which was uploaded to the device during manufacturing process
XML settings	assigns XML settings template
Geozone group	uploads selected geofences
Dallas ID list	uploads selected dallas ID list
Use server settings	enables server settings
Server Host	sets server host IP (default: dt1.fmset.eu)
Port	sets server port (default: 8412)
Vehicle model	Not active at the moment
Main protocol	device communication protocol (TCP/UDP)
1 st custom value	Custom value
2 nd custom value	Custom value
Template	If checkbox is marked, device is added to templates menu
Drop retranslators	If checkbox marked, deletes retranslators
Drop retranslators and assign direct transfer	If checkbox is marked, assigns IP and port which was set in retranslators tab to direct transfer and deletes the retranslator at the same time
Direct host	assigns host to direct transfer (monitoring platform)
Direct port	assigns port to direct transfer (monitoring platform)
Direct protocol	device communication protocol for direct transfer (TCP/UDP)
APN name	Access point name (address)
APN user	Access point name (user)
APN password	Access point name (password)
Service1 SMS number	service telephone number
Service2 SMS number	service telephone number
Use tachograph	Enables tachograph using for device
Card authentication server address	Address of Card authentication server
Card authentication server port	Port of Card authentication server
Data files server address	Address of Data files server

Data files server port	Port of Data files server
Use data files server to manage requests	Possibility to make request directly from Data files server
Activities of specified calendar days	Use to define period of DDD file. Default is 90 days.
Days	Duration of period for DDD file

The upper symbol is used to monitor device status (Picture 7).

862462031276123

Updated: 8/24/2017 17:47:10

Position time: 8/24/2017 17:40:07
 Position: [-6.80539,39.2128](#)
 Satellites: 12
 HDOP: 1

Inputs' time: 8/24/2017 17:40:07

IN1	Motion			
IN2	IN3	IN4	IN5	Digital inputs
IN6	Voltage threshold on ADC input			
IN7	Engine running			
IN8	Power supply voltage threshold			
IN9	IN10	IN11	IN12	
IN13	IN14	IN15	IN16	

Settings state: Updated (Last update time: 5/13/2017 12:11:22)
 Firmware state: Updated
 Current firmware
 version QCLT
 Preferred firmware
 version QCLT
 Last activity: ~7 minute(s) ago

Picture 7. Real time device state.

As we can see, main parameters are represented in this picture: IMEI; position time; coordinates; satellites count; HDOP; Input time and status (active/inactive); XML settings state; firmware state; last activity. This function is very convenient when you want to check device state fast and help with device surveillance.

The middle button (Picture 5.) will open device logs in new window (Picture 8).

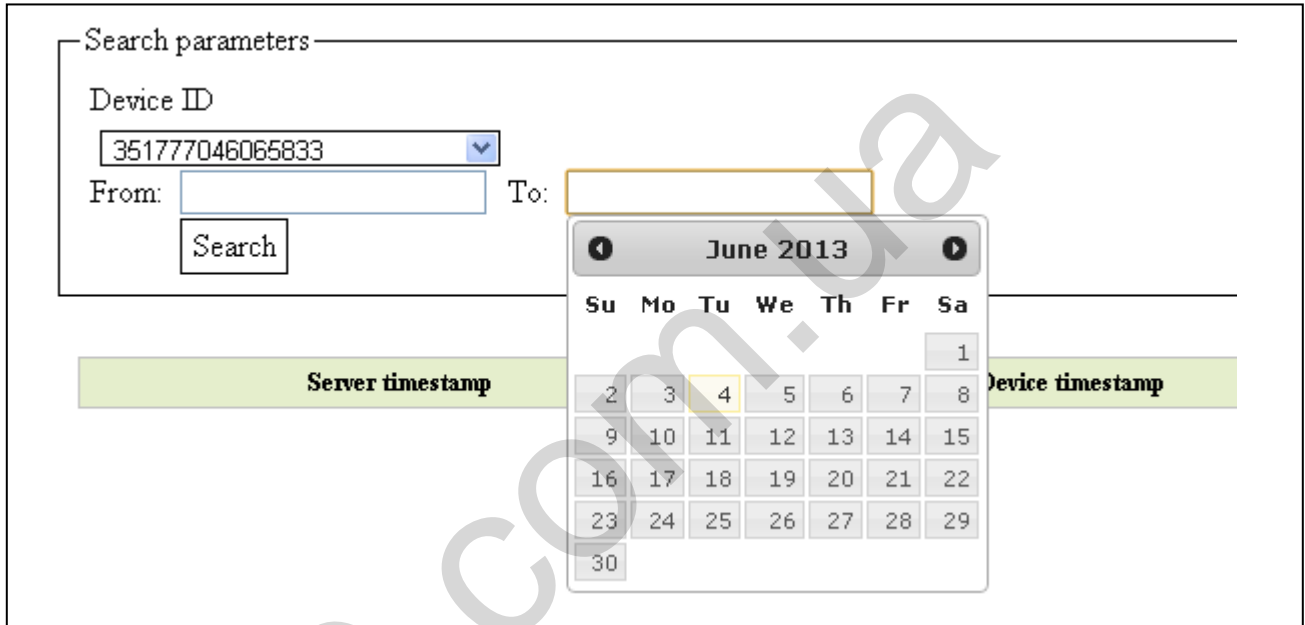

Picture 8. Device logs

IMEI is picked automatically, you just need to choose period for which you want to see device logs and hit search button. Logs are represented in a code and has an explanation. These logs let our team to identify and solve various problems, which are related to our device or operator service.

Note. Only most important events are described in the logs.

By clicking lower button (Picture5.) you are able to download configuration file to your PC. It includes all the Device Settings (such as Server configuration, APN configuration, SIM number, firmware and other) and XML settings. This file can be uploaded to the devices via USB.

Retranslators

If there is a need, for some tracking platforms, for proper data sending retranslators can be created (Picture 9). Retranslator type should be set and server address and port entered, f.e.:

Retranslator type – Wialon IPS

Server address – 193.193.165.165:20482

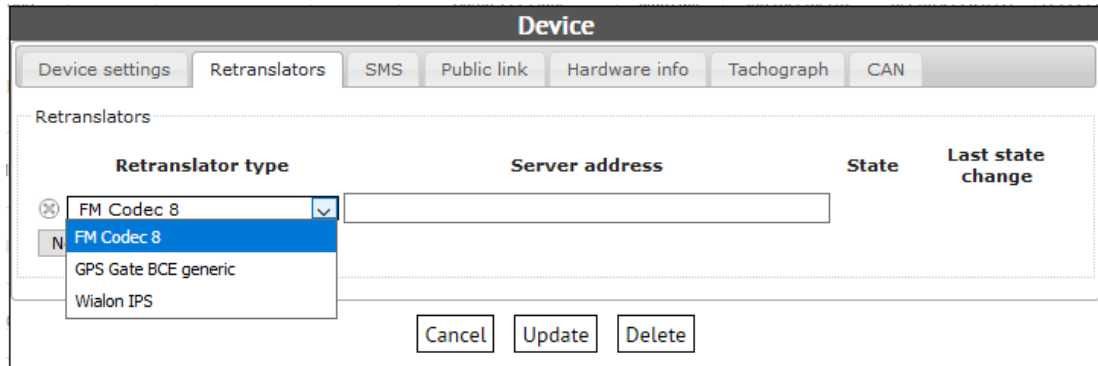

Picture 9. Retranslators

At the moment retranslator supports following protocols:

- FM Codec 8
- GPS Gate BCE generic
- Wialon IPS

3.1.3. Firmware

Firmware is the combination of persistent memory and program code and data stored in it. It provides the control program for the device.

Firmwares are created and uploaded by BCE team. They are sorted by device version.

KB – 4th hardware version

VB – Basic line hardware version

LB – 4.5 hardware version

VC – FM-One hardware version

MB – 5th hardware version

VS – FMS hardware version

ZB – 5.4 hardware version

VU – Tacho hardware version

QB – 5.5 hardware version

You can see in the notes what updates were made in specific firmware.

Version	Content size, B	Hardware check rule	Notes
MB65	111924	^VM	Fixed J1939 issue of MB64.
MB67	114340	^VM	New function to cycle network registration if internet connection failed. 1W9 bit temperature sensor support.
MB68	126820	^VM	Odometer fix. CAN functions test.
MB71	127412	^VM	J1708 fix causing module to reboot. Manufacturer specific CAN messages fix.
MB73	127780	^VM	Interrupt priority changed in J1708.
MB74	124548	^VM	Peugeot Boxer (11+) EMT and Travel sim apn detection. Beeline RU m2m apn detection.
MB75	124708	^VM	LLS Sensor reading on RS232.
MB76	124724	^VM	LLS Sensor reading on RS232 second edition.
MB77	124724	^VM	LLS Sensor reading on RS232 third edition.

Picture 10. Firmware list example

3.1.4. GSM operator groups

GSM operator group is used for more accurate device connection to operators. By setting up a group, you point device to connect to preferred operator from the list. There are two possibilities:

1. Create and assign operator group to device. When starting new operator search device will first try to connect to operator from the list, but if preferred operator is not available, device will connect to any other operator visible in that area.
2. Create and assign operator group to device, as well as set up function “2.1 F_InternetConnection” with value “Permit” only when preferred operator active. This way device won’t connect to internet if connected to a non preferred operator.

As you can see in picture 11, you need to fill in groups name, set up a dealer, fill in some notes if needed and enter preferred operators codes. Code consists of five digits, first three digits stands for mcc (mobile country code), it depends on the country. Last two digits stands for mnc (mobile network code), it defines specific operator.



Picture 11. Operator group example

3.1.5. XML settings

XML settings may be uploaded to the device and used to tune it for the best performance and requirements of your system. You will find several prepared settings created by Baltic Car Equipment team. However, you may create settings that meet your specific needs. After the settings are ready, click Create.

XML settings template must be created and assigned to device in Device Settings (Picture 4). It helps you control your devices:

- Enable/disable preferred parameters
- Set data fix and data send periods
- Control physical and virtual inputs/outputs
- Set internal functions (timers, odometer, sleeping)
- Configure EIA485, RS232, 1-WIRE, CAN communication bus

XML settings template includes many functions and signal conditions, which makes device widely adaptable and allows you to obtain high functionality. Main steps of settings creation are represented in Picture 12.

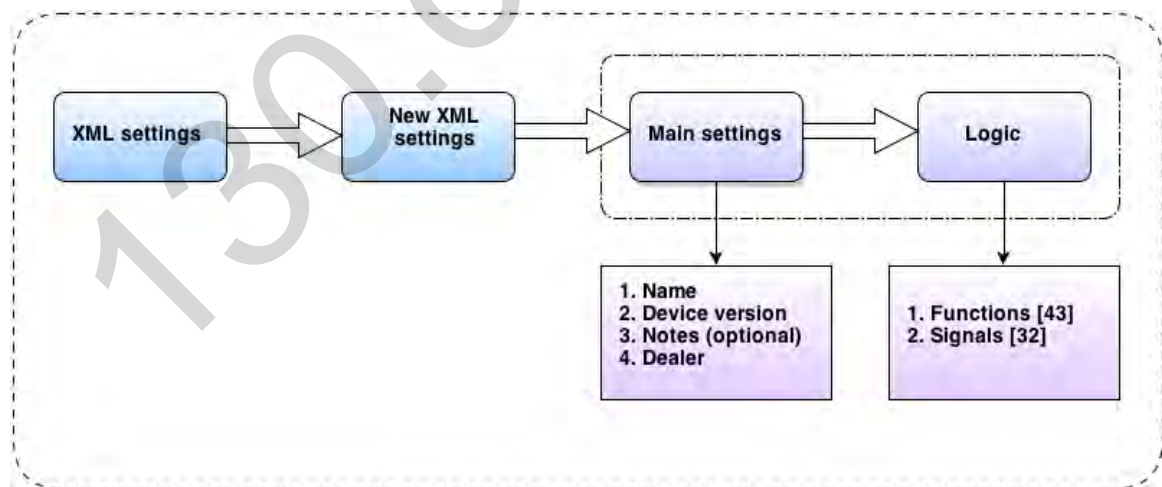

Picture 12. XML set up scheme

New XML settings

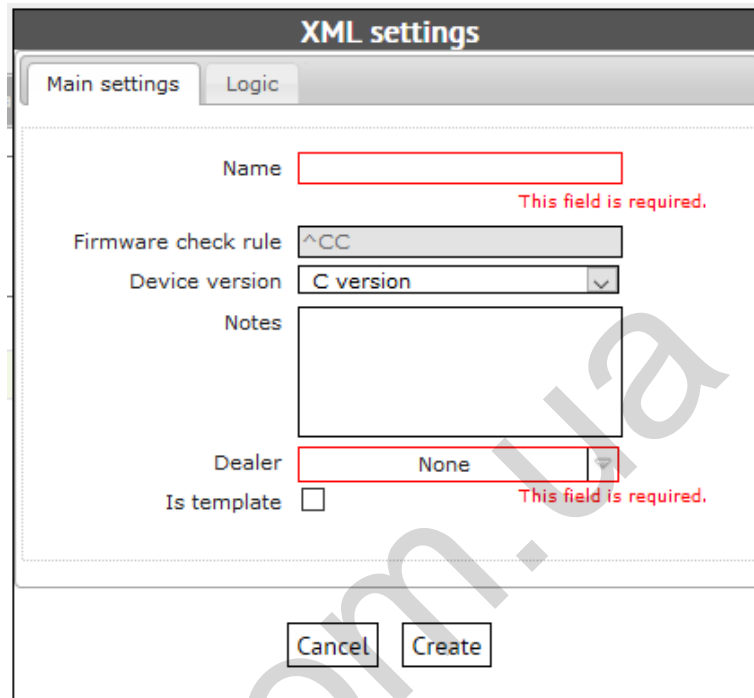

Picture 13. New XML settings main window

In the first window you must set up primary parameters: a) Name; b) Device version (optional); c) Notes (optional); d) Dealer

3.1.6. Device logic

When pressed “logic” tab, functions list will appear. By pressing “plus” symbol in the left side of the functions name, you will add parameters to every function. Parameters quantity is unlimited. As you can see in Picture14, parameters are represented in a code. This code refers to parameters value and its signal condition.



Picture 14. Logic template example

When you add a parameter, second step is to set its value and pick signal conditions (if needed).

There are three possible conditions:

- a) Present IN1 - motion
- b) Not present IN1 - motion
- c) Don't care IN1 - motion

In the example below (Picture 15) you can see internet connection configuration. Value is set to “permit” if specific conditions are met (device is not in roaming network; IN1 – motion is detected; IN5 is detected).

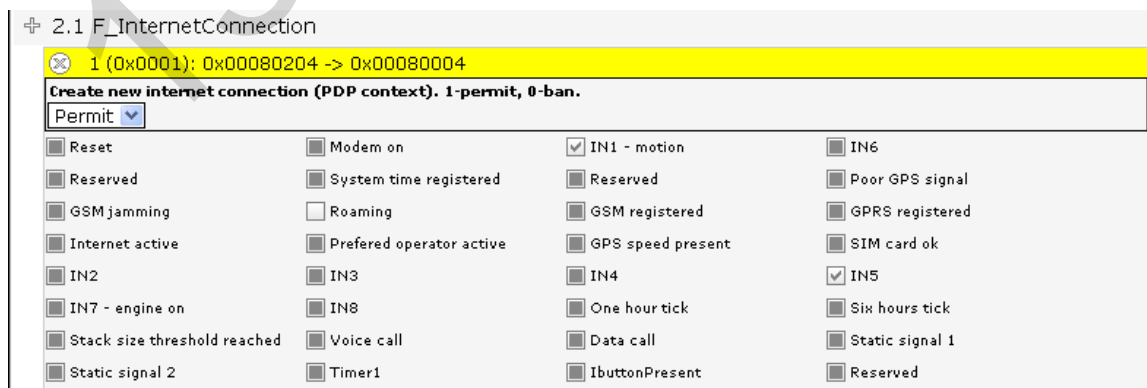

Picture 15. Functions parameter

There are three possible value formats: a) drop box; b) check box; c) numeric value; d) Time interval (made specifically for “TIMER1” function).

All signal conditions and all functions are described in Table1 and Table2.

Once settings are created, you can easily find them using search tool. Two search filters are available: a) Name; b) Dealer;

In order to avoid the creation of settings from the beginning copy function was added. Open already created settings - “Duplicate” button will appear. This way you will be able to create many setting templates in a short time.

130.com.ua

3.1.7. Function signals

Signal name	Signal description
Reset	Turn on temporarily after the system is restarted to indicate the event
Modem on	Modem of the device is enabled
IN1 – motion	Virtual input, used for motion detection
IN6	Virtual programmable input
Timer3Threshold	Special structure for internal timer signal
System time registered	The device has turned UTC time internally from GPS or internet
Geozone inside	Internal, virtual signal for Geozones.
Poor GPS signal	GPS signal does not meet the minimum requirements according to “F_GpsQualityMaxHdop” and “F_GpsQualityMinSat”
GSM jamming	GSM/DCS jammer is detected and it is disturbing normal use of GSM/DCS service
Roaming	Device is registered to a roaming network
GSM registered	Device is registered to any network
GPRS registered	Device is registered to GPRS data services
Internet active	Device is connected to internet
Preferred operator active	Device is registered to an operator from the preferred list
GPS speed present	GPS speed detection over 10km/h
SIM card ok	SIM card is inserted and PIN code removed
IN2	Physical – digital input
IN3	Physical – digital input
IN4	Physical – digital input
IN5	Physical – digital input
IN7 – engine on	Virtual input, battery charging detected
IN8	Virtual programmable input
One hour tick	Every hour for 10 minutes period
Six hour tick	Every six hours for 10 minutes period
Stack size threshold reached	There is more data in stack than allowed
Voice call	Voice call detected, settings locked for 30 minutes
Data call	Data call detected, settings locked for 30 minutes
Static signal 1	General first static signal
Static signal 2	General second static signal
Timer1	Special structure for internal timer signal
IbuttonPresent	“Dallas key” detected
Timer2Threshold	Special structure for internal timer signal

Table1. Signal descriptions

3.1.8. Functions

Functions name	Description/value expression
1.1 F_ModemPower	GSM modem power mode (on/off)
1.2 F_GpsPower	GPS device power mode (on/sleep)
2.1 F_InternetConnection	Create new internet connection (PDP context*). Possible values: permit – allows to create new internet session; ban – doesn't allow new internet session, after old one is destroyed from operator side; force disconnect – device destroys internet session immediately;
2.2 F_ServerConnection	Controls connection to server (connect/disconnect after 10 minutes)
2.3 F_DataSendPeriod	Period in which data is sent to server (automatic/custom)
2.4 F_DataSendOnInputsChange	Mask of inputs which may generate data transmission without waiting period timeout (tick a check-box to select desired input)
2.5 F_BroadcastMessagesPeriod	Broadcast messages without confirmation. Used for data fix and send to server, when frequent transmission is needed.
3.1 F_GpsQualityMaxHdop	Maximum HDOP* of position to accept it to read (Recommended value – 35)
3.2 F_GpsQualityMinSat	Minimum satellites count for acceptance to read it
3.3 F_GpsReadPeriod	Period in which coordinates are read from GPS and put to internal track filter (never/value=seconds)
3.4 F_MaxTimeBetweenTwoGpsPoints	Maximum time between two fixed points (never/value=seconds)
3.5 F_GpsCourseChangeFix	Minimum course change for device to fixate it (value expressed in degrees)
3.6 F_GpsSpeedChangeFix	Fixation of vehicles speed difference from the last set value (expressed in km/h)
3.7 F_InputsChangeFix	Registers change of selected input state (tick a check-box to select desired input)
3.8 F_MaxDistanceBetweenTwoGpsPoints	Maximum distance between two gps points. Min – 0; Max – 65536. Value = meters.
4.1 F_Dataset7_Mask1	Selected data will be included into the data packet (chapter 3.1.12)
4.2 F_Dataset7_Mask2	Selected FMS-CAN (J1939)* data will be included into the data packet (chapter 3.1.13)
4.3 F_Dataset7_Mask3	Selected data will be included into the data packet (chapter 3.1.14)
4.4 F_Dataset7_Mask4	Selected data will be included into the data packet (chapter 3.1.15)

4.5 F Dataset7 Mask5	Selected data will be included into the data packet		
5.1 F_GeneralBitConfig	General bit configuration (tick a check-box to select desired function)		
	<table border="1"> <tr> <td data-bbox="824 342 1174 457">Battery charge</td> <td data-bbox="1182 342 1536 457">enables battery charge connected on ADC6 (just for 5.1 version)</td> </tr> </table>	Battery charge	enables battery charge connected on ADC6 (just for 5.1 version)
	Battery charge	enables battery charge connected on ADC6 (just for 5.1 version)	
	<table border="1"> <tr> <td data-bbox="824 457 1174 489">Odometer</td> <td data-bbox="1182 457 1536 489">relative odometer</td> </tr> </table>	Odometer	relative odometer
	Odometer	relative odometer	
	<table border="1"> <tr> <td data-bbox="824 489 1174 562">Disable position pinning</td> <td data-bbox="1182 489 1536 562">position pinning algorithm</td> </tr> </table>	Disable position pinning	position pinning algorithm
	Disable position pinning	position pinning algorithm	
	<table border="1"> <tr> <td data-bbox="824 562 1174 678">Disable fuel approximation</td> <td data-bbox="1182 562 1536 678">fuel approximation on lv11-lv12 and c1-c4 parameters</td> </tr> </table>	Disable fuel approximation	fuel approximation on lv11-lv12 and c1-c4 parameters
	Disable fuel approximation	fuel approximation on lv11-lv12 and c1-c4 parameters	
	<table border="1"> <tr> <td data-bbox="824 678 1174 751">Enable wiegand26</td> <td data-bbox="1182 678 1536 751">wiegand26 protocol for RFID readers</td> </tr> </table>	Enable wiegand26	wiegand26 protocol for RFID readers
	Enable wiegand26	wiegand26 protocol for RFID readers	
	<table border="1"> <tr> <td data-bbox="824 751 1174 825">Reset Wiegand value</td> <td data-bbox="1182 751 1536 825">Conditions to reset wie parameter</td> </tr> </table>	Reset Wiegand value	Conditions to reset wie parameter
Reset Wiegand value	Conditions to reset wie parameter		
<table border="1"> <tr> <td data-bbox="824 825 1174 867">Disable events</td> <td data-bbox="1182 825 1536 867">system logs</td> </tr> </table>	Disable events	system logs	
Disable events	system logs		
<table border="1"> <tr> <td data-bbox="824 867 1174 1014">Disable data sending</td> <td data-bbox="1182 867 1536 1014">– disables data sending from flash (doesn't affect broadcast messages)</td> </tr> </table>	Disable data sending	– disables data sending from flash (doesn't affect broadcast messages)	
Disable data sending	– disables data sending from flash (doesn't affect broadcast messages)		
<table border="1"> <tr> <td data-bbox="824 1014 1174 1129">Enable CAN fuel approximation</td> <td data-bbox="1182 1014 1536 1129">Useful for the vehicle where fuel level from CAN is not stable</td> </tr> </table>	Enable CAN fuel approximation	Useful for the vehicle where fuel level from CAN is not stable	
Enable CAN fuel approximation	Useful for the vehicle where fuel level from CAN is not stable		
<table border="1"> <tr> <td data-bbox="824 1129 1174 1203">Reset Ibutton value</td> <td data-bbox="1182 1129 1536 1203">resets dallas_id_end parameter</td> </tr> </table>	Reset Ibutton value	resets dallas_id_end parameter	
Reset Ibutton value	resets dallas_id_end parameter		
<table border="1"> <tr> <td data-bbox="824 1203 1174 1308">Continuous odometer mode</td> <td data-bbox="1182 1203 1536 1308">Odometer value is summed up in device memory</td> </tr> </table>	Continuous odometer mode	Odometer value is summed up in device memory	
Continuous odometer mode	Odometer value is summed up in device memory		
<table border="1"> <tr> <td data-bbox="824 1308 1174 1381">IN6 source ADC5</td> <td data-bbox="1182 1308 1536 1381">To change IN6 from ADC3 to ADC5</td> </tr> </table>	IN6 source ADC5	To change IN6 from ADC3 to ADC5	
IN6 source ADC5	To change IN6 from ADC3 to ADC5		
5.2 F_VibrationThreshold	Vibration (IN1) threshold (if value > selected threshold, IN1-motion=1). Used for detecting motion, recommended value - 200		
5.3 F_NotDeliveredDataThreshold	Stack size threshold to generate signal “Stack size threshold reached”. Value expressed in bytes.		
5.4 F_In8VoltageThreshold	Power supply voltage threshold. Expressed in volts (if value > threshold, IN8=1)		
5.5 F_In6VoltageThreshold	ADC3 voltage threshold. Expressed in volts (if value > threshold, IN6=1)		
5.6 F_FrequencyCounterSelect	Input mask for counter – frequency mode (tick a check-box to select desired input mode). Used for sensors, to work in counter or frequency mode		
5.7.1 F_Can1FunctionSelect	Selects CAN function. Enables CAN bus reading. Possible values: J1939-FMS; J1939 OBDII*; J1939		

	FMS ACK; J1939 FMS request; J1939 FMS (500kbps); List of light vehicles with CAN bus support (periodically updated);
5.7.2 F_Can2FunctionSelect	Selects CAN function. Usually used to read Tachograph with FM Tacho.
5.8 F_EIA485FunctionSelect	RS485* function select. Enables RS485 input reading. Used for LLS*sensors and J1708*. ES4 sensor reading – EPSILON fuel level sensors. RS485 Keypad. Tyre pressure sensors.
5.9 F_RS232FunctionSelect	LLS sensor reading – OMNICOMM fuel level sensors connected via RS232; NMEA output – GPS information transfer from our device to external device; ES2 sensor reading – EPSILON fuel level sensors; Terminal – device works like communication terminal between monitoring platform and external device (sends information in text format); CAN LOG – work with additional CAN bus module “CAN-LOG”; RFID TYP A – specific RFID card reader; ADP-400 C – Rx input is used for communication between FM Blue and ADP CAN alarm system (just for 5.4 and 5.5 FM Blue+ devices). “6 pin Light 1 Wire power supply” function is to be used if connecting 1 Wire sensors to the FM Light devices. Datacold temperature reading. And more.
5.a F_NewConectionsToInternetLimiter	Limits next possible connection to internet (value expressed in seconds)
5.b F_Timer1	Special structure for internal timer signal
5.c F_Timer1_GMT	Used to set GMT value.
5.d F_Timer2_Control	Special structure for internal timer signal
5.e F_Timer2_Threshold	Time threshold expressed in seconds. Used with 5.d function
5.f F_OUT1_Control	Function for OUT1 output control. Works in six modes: off1 – output disabled, but can be controlled with GPRS commands; on (minus) – enabled; off2 – disabled; long – long pulses – two long impulses; short – short – short pulses – three short impulses; short – long – short pulses – one short, one long and one short impulse;
5.g F_OUT2_Control	Function for OUT2 output control. Works in three modes: off1 – output disabled, but can be controlled with GPRS commands; on (minus) – enabled; off2 – disabled;
5.h F_OUT3_Control	Function for OUT3 output control. Works in three modes: off1 – output disabled, but can be controlled with GPRS commands; on (minus) – enabled; off2 –

	disabled;
5.i F_DigitalInputsthreshold	Digital input (IN2-IN5) threshold. Min – 0; Max – 40. Value = volts.
5.j F_GPS_Speed_Threshold	GPS speed threshold (GPS speed present). Value = km/h.
5.k F_S1_Control	Static signal 1 status control (on; off; auto)
5.l F_S2_Control	Static signal 2 status control (on; off; auto)
5.m F_Data_Delivery_Watchdog	GSM modem watchdog. Restart is executed if in the fixed period, server hasn't responded to the device.
5.ma F_Timer3_Control	Special structure for internal timer signal
5.ma F_Timer4_Control	Special structure for internal timer signal
5.na F_Timer3_Threshold	Time threshold expressed in seconds. Used with 5.ma function
5.na F_Timer4_Threshold	Time threshold expressed in seconds. Used with 5.ma function
5.o 1W_Function	Method of activation and reading of 1Wire input
6.1 Crash Pulse Lenght	Period of force acting a vehicle (ms)
6.2 G1 force start value	Value of G power at starting point
6.3 G2 force mean value	Average value of G power during 6.1 period
6.4 F_Dataset4_Timeout	Period for registering analog inputs using digital filtering method
6.5 F_Dataset51_Timeout	Period for registering FMS-CAN data
6.6 F_Dataset8_Timeout	Type8 filter
6.7 F_Sms_TrigerMaskRising	Sms mask value. Sending sms when changing from 0 to 1 (tick a check-box to select desired input)
6.8 F_Sms_TrigerMask_Faling	Sms mask value. Sending sms when changing from 1 to 0 (tick a check-box to select desired input)
6.9 F_Sms_NextSmsTimeout	Next sms timeout. Expressed in seconds
6.a F_Sms_MaxSmsPerHour	Maximum sms per hour
6.b F_AccelerationThreshold	Threshold of acceleration (G) generating "Modem On" signal
6.c F_BrakingThreshold	Threshold of braking (G) generating "Modem On" signal
6.d F_CorneringThreshold	Threshold of cornering (G) generating "Modem On" signal
7.1 F_Device_Sleep	Conditions for device to go sleeping an waking up
7.2 F_Sleep_Timeout	If in 7.1 is set to Wake up on Timeout
7.3 F_Stay_away_timeout	Time to stay awake after waking up after Timeout

Table 2. Function descriptions

- HDOP – horizontal dilution of precision. This gives an indication of precision of the position fix from GPS, based on the satellites it is currently using and its geometry.
- PDP context – packet data protocol context is a term used in the mobile wireless network indicating a logical association between an MS (mobile station) and PDN (Public data network) running across a GPRS network. The context defines aspects such as routing, qos (quality of service), security, billing etc.
- FMS-CAN (J1939) – “fleet management systems” interface is a standard interface to vehicle data of commercial vehicles. J1939 is a vehicle bus standard used for communication and diagnostics among vehicle components.
- OBD-II – on board diagnostics, is an automotive term, referring to a vehicles self-diagnostic and reporting capability. The OBD-II standard specifies the type of diagnostic connector and its pinout, the electrical signaling protocols available, and the messaging format.
- EIA-485, also known as TIA/EIA-485 or RS-485, is a standard defining the electrical characteristics of drivers and receivers for use in balanced digital multipoint systems.
- J1708 - standard used for serial communications between ECU (Electronic control unit) on a heavy duty vehicle and also between a computer and a vehicle.
- LLS – Liquid level sensor

3.1.9. Configuration examples

5.1 F_GeneralBitConfig includes two functions:

- a) Battery charge
- b) Odometer

By ticking odometer checkbox, you enable/disable internal odometer, which is represented in device messages and can be used as mileage counter. Internal odometer was calibrated by our engineers on a referenced road and had a deflection of 0.2%.

Battery charge function is needed when external battery is used. When function is enabled, PLUS [+] signal is generated on the “EXT BAT” output. It is advisable to assign IN5 (ignition) condition to this function, that external battery would be charged only when vehicles engine is working.

5.3 F_NotDeliveredDataThreshold. Generates signal – stack size threshold reached. You can use this signal in any other function. Just set the limit of bytes and change condition of your preferred function (1. Not present; 2. Present).

Example:

Set the limit of threshold (10000 bytes). Select function 1.1 F_InternetConnection. Change signal (stack size threshold reached) condition to – “present” (picture4). Result: device connects to internet only when data limit in internal memory is reached.

5.7 F_CanFunctionSelect. Used for vehicles with CAN bus interface. Select the value from the list depending on protocol which is used in your vehicle.

Example:

J1939 FMS – message protocol for bus, truck and trailer market. Working without requests.

J1939 FMS Request – reading J1939 messages only with requests.

J1979 OBD II (On board diagnostics) – standard, that specifies the type of diagnostic connector and its pinout, the electrical signaling protocols available and the messaging format. Uses J1979 protocol.

J1939 FMS ACK – similar to other J1939 protocols, just makes confirmations for successfully transmitted data.

5.8 F_EIA485FunctionSelect. This function lets you control RS485 interface. It can be used for LLS sensor connection (up to 4 sensors), and Volvo/Renault CAN bus reading.

If you use LLS sensors, select value – “LLS sensor reading” (4.3 F_DataSet7_Mask3 functions parameters – “LLS group1” and “LLS group2” must be enabled).

“J1708 No FMS gateway” is used for vehicles without gateway, reading with requests. “J1708 FMS gateway reads CAN bus without requests.

5.b F_Timer1 function generates signal “Timer1”, which you can use in any other function as its condition. As you can see in the function window, you can pick “work days” – days, when signal will be active, “Signal on time” – at this specific time signal is activated, “Signal off time” – at this specific time signal is deactivated.

This function could be convenient for clients, whose vehicles work at specific days and hours. Just set the time and change signal condition in preferred functions (f.e. 2.1 F_InternetConnection or 2.2 F_ServerConnection).

Function 5.c F_Timer1_GMT is used jointly for setting your time zone.

5.d F_Timer2_Control and 5.e F_Timer2_Threshold forms another set of programmable timer. Timer2 signal is generated and can be chosen from conditions list. Timer2_Control has the following values:

- a) Pause
- b) Time increment
- c) Time decrement
- d) Reset to 0
- e) Value at 60 sec.
- f) Value at 60 min.

Time increment – time increases every one second.

Time decrement – time decreases every one second.

Reset to 0 – timer is reset to 0.

Value at 60 sec. – timer set for 60 seconds.

Value at 60 min. – timer set for 60 minutes.

Timer2_Threshold – is a limit expressed in seconds. Just set desirable threshold, pick a value in Timer2_Control and Timer2 signal is ready to use.

Example. Threshold is set to 40 seconds, value set at 60 seconds (when ibutton present), time decrement (when ibutton not present). It means that when device reads ibutton, timer is set for 60 seconds, user pulls back ibutton – time starts to decrement until reaches 40 seconds limit, then signal is

deactivated. Signal is active for 20 seconds, you can use this time to control other preferred function (f.e. OUT1).

In this example three functions was combined. Often it will be used for complex operations.

130.com.ua

3.1.10. Geozones and Geozone groups

This feature allows to upload Geozones (geofences) into internal device memory. Firstly, in Geozone group tab, a group of geozones must be created.

In Geozones tab, upload (import) your geozones to Configuration manager by clicking “Import geozones from KML”. Select the geozone you need and assigned to the group by clicking “Add selected geozones to group”. Created group can be set for a specific device. In that way one or more Geozones will be uploaded to the device. After group is set for a device, function signal “Geozone inside” is ready to use (Picture16). Possible to configure any function depending on this signal (connect to internet/server; activate output; turn on/off GPS).

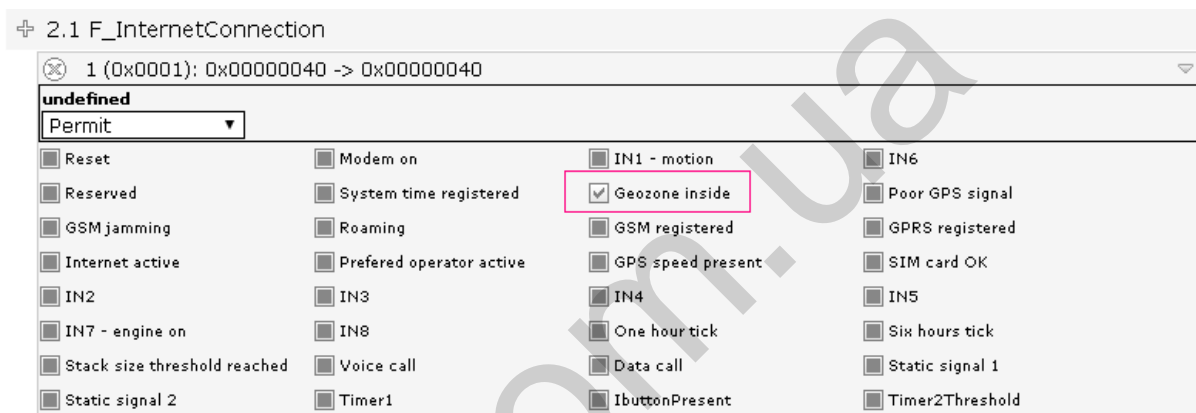

Picture16. Geozone inside

Notes.

- Geozones can only be imported in KML format
- Geozones must be polygon type
- Device can write in its internal memory up to 2000 points
- Configuration manger will show number of points for a specific Geozone, its status (valid/not valid) and every zone size.

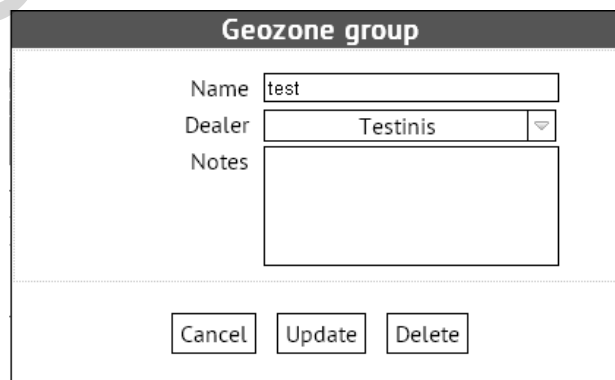

The 'Geozone group' dialog box contains the following fields and controls:

- Name:** A text input field containing the value 'test'.
- Dealer:** A dropdown menu currently showing 'Testinis'.
- Notes:** A large empty text area for additional information.
- Buttons:** Three buttons at the bottom: 'Cancel', 'Update', and 'Delete'.

Picture 17. Geozone Group

BCE devices at the moment support operating in three types of zones: Geozone inside, Double geozone inside, Outside of geozone.

3.1.11. Dallas ID lists

This tool allows to create Dallas ID list/group, which will be uploaded to the device. Dallas ID is an identification number, usually used to identify drivers. This list of specific numbers allows device to recognize identification key and execute a command depending on it. Possible to enter one or more ID into the list(Picture18).

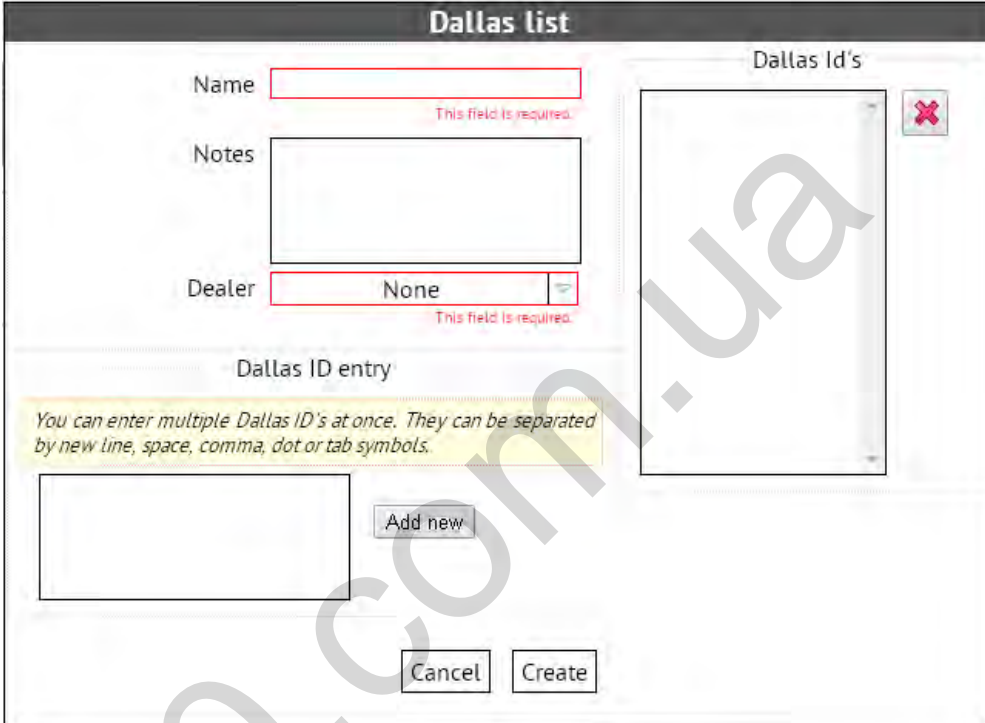

Dallas list

Name This field is required.

Notes

Dealer This field is required.

Dallas ID entry

You can enter multiple Dallas ID's at once. They can be separated by new line, space, comma, dot or tab symbols.

Dallas Id's

Picture 18. Dallas ID list

Notes.

- Dallas ID must be entered in HEX format
- One device can support up to 100 identification numbers
- Additional equipment must be connected to the device (1-wire reader)

3.1.12. Dataset7_Mask1 description table

Parameter	Description	
Coordinates	This parameter includes:	
	Longitude	HDOP
	Latitude	Course
	Speed	Altitude
	Satellites	Odometer
Digital inputs	IN1 – IN16. Control of physical and virtual digital inputs.	
ADC1	Reserved	
ADC2	Board voltage. Shown as adc12 in wialon	
ADC3	Analog input. Physically shares same pin with OUT2.	
ADC4	Analog input. Physically shares same pin with IN2	
ADC5	Analog input	
ADC6	Battery voltage. Shown as adc16 in wialon	
ADC7	Reserved	
ADC8	Reserved	
c1,c2	Counter/Frequency parameters group. Represents IN2, IN3 inputs.	
c3,c4	Counter/Frequency parameters group. Represents IN4, IN5 inputs.	
LVL1	Used for analog sensors connection. Represents ADC3 input. Shows approximated value.	
LVL2	Used for analog sensors connection. Represents ADC4 input. Shows approximated value.	
GSM info	This parameter includes:	
	mcc (mobile country code)	
	mnc (mobile network code)	
	lac (local area code)	
	cell_id (ID of station to which device is connected at the moment)	
	gsm_lvl (strength of GSM signal [dBm])	
ta (distance to nearest station)		

Table3. Dataset

3.1.13. Dataset7_Mask2 description table. FMS-CAN (J1939)

Parameter	Description	
Wheel speed	Speed of the vehicle as calculated from wheel or tail-shaft speed.	
Acceleration pedal	The ratio of actual position of the analogue engine speed/torque request input device to the maximum position of the input device.	
Total fuel	Accumulated amount of fuel used during vehicle operation.	
Fuel level sensor	Ratio of volume of fuel to the total volume of fuel storage container.	
Tachometer	Engine speed	
Engine hours	Accumulated time of operation of engine.	
Mileage	Distance travelled.	
Engine temp.	Temperature of liquid found in engine cooling system.	
Fuel level[2]	When Fuel Level 2 is used, Fuel Level 1 represents the fuel level in the primary or left-side fuel storage container.	
Engine load	Engine percent load at current speed	
Service distance	The distance which can be travelled by the vehicle before the next service inspection is required.	
TCO1*	This parameter includes:	
	Driver1 working state	Driver2 working state
	Vehicle motion	System event
	Driver1 time related status	Driver2 time related status
	Driver1 card	Driver2 card
	Handling information	Tachograph performance
	Tachograph vehicle speed	Direction indicator
	Vehicle overspeed	Reserved
Air temp.	Temperature of air surrounding vehicle.	
Driver ID	Driver identification. The driver ID is only available if a digital tachograph is present	
Fuel rate	Amount of fuel consumed by engine per unit of time	

Table 4. Dataset

TCO1 – Tachograph

- Vehicle motion – indicates whether motion of the vehicle is detected or not.
- Vehicle overspeed – indicates whether the vehicle is exceeding the legal speed limit set in the tachograph.
- Driver card – indicates the presence of a driver card.
- Driver time related status – indicates if the driver approaches or exceeds working time limits (or other limits).
- Direction indicator – indicates the direction of the vehicle.

- Tachograph performance – indicates the tachograph performance; including electronic or mechanical analysis, instrument analysis, speed sensor analysis, mass storage analysis and printer analysis.
- Handling information – indicates that handling information is present.
- System event – indicates that a tachograph event has occurred. This may include power supply interruption, interruption of the speed sensor, incorrect data on the driver card, driving without a driving card, illegal removal of a driver card, insertion of a driver card during driving, and time adjustment.

130.com.ua

3.1.14. Dataset7_Mask3 description table

Parameter	Description	
J1939 fuel economy	Current fuel economy at current vehicle velocity	
J1939 fuel consumption	Accumulated amount of fuel used during vehicle operation. High resolution used for calculations and fleet management systems.	
J1939 axle weight	Total mass imposed by the tires on the road surface at the specified axle.	
J1939 mil status	malfunction light	
J1939 DTC1-10	Not used yet	
CarInPhone	This parameter includes:	
	Armed	Locked
	Drivers front door	Drivers back door
	Passengers front door	Passengers back door
	Bonnet	Trunk
	Alarm	Shock sensor
	External	Tilt sensor
	Original alarm	Ignition
Service	Ignore	
1-Wire ID	Connection for i-button	
1-Wire Temp	Connection for temperature sensor	
1-Wire Humidity	Connection for humidity sensor	
LLS Group1	LLS sensor parameters	
LLS Group2	LLS sensor parameters	
J1979 Group1	This parameter includes:	
	Malfunction indicator lamp	calculated engine load value
	Engine coolant temperature	Fuel pressure
	Short term fuel trim bank1	Long term fuel trim bank1
	Short term fuel trim bank2	Long term fuel trim bank2
	Intake manifold absolute pressure (MAP)	Engine RPM
	Vehicle speed	Intake air temperature
	MAF (mass air flow) air flow rate	Throttle position
Fuel level input	Fuel rail pressure	
J1979 DTC1-10	Not used yet	
J1708 Group1	This parameter includes:	
	Engine hours	
	Total fuel used	
Fuel level		
Driving quality matrix	Special parameters for driving quality evaluation	

Table 5. Dataset Mask3

3.1.15. DataSet7_Mask4 Description table

Parameter	Description
Wiegand26 ID	Parameter for RFID, using wiegand26 protocol
LLS Group3	LLS parameter group. Up to 14 LLS sensors using RS485. Enables parameters from 5 to 14.
CAN fuel consumption	instantaneous fuel consumption. Works only from 5.4 version
Axle group	Represents up to 5 axle parameters (depending on vehicle)
AddBlue	Diesel exhaust fluid level (CAN bus)
Previous digital inputs	Previous digital input value (I/O)
Acceleration max values	Special structure for driving quality evaluation
Mobileye data	Mobileye security system support (CAN bus)
1 Wire temp sensors	Several temperature sensors' ID and value
Tacho drivers ID	Driver's ID from tachograph
Tacho odometer	Odometer data from tachograph
Data cold temperatures	Temperatures from Datacold equipment
RPM limit timer	Measuring the duration of over RPM
Crash data	Measuring special accelerometer's parameters

Table 6. Dataset Mask4