



PHONES

0 (800) 800 130  
(050) 462 0 130  
(063) 462 0 130  
(067) 462 0 130

130  
COM.UA

Internet store of  
autogoods



SKYPE

km-130

CAR RECEIVERS — Receivers • Media receivers and stations • Native receivers • CD/DVD changers • FM-modulators/USB adapters • Flash memory • Facia plates and adapters • Antennas • Accessories |  
CAR AUDIO — Car audio speakers • Amplifiers • Subwoofers • Processors • Crossovers • Headphones • Accessories | TRIP COMPUTERS — Universal computers • Model computers • Accessories |  
GPS NAVIGATORS — Portable GPS • Built-in GPS • GPS modules • GPS trackers • Antennas for GPS navigators • Accessories | VIDEO — DVR • TV sets and monitors • Car TV tuners • Cameras • Videomodules  
• Transcoders • Car TV antennas • Accessories | SECURITY SYSTEMS — Car alarms • Bike alarms • Mechanical blockers • Immobilizers • Sensors • Accessories | OPTIC AND LIGHT — Xenon • Bixenon • Lamps  
• LED • Stroboscopes • Optic and Headlights • Washers • Light, rain sensors • Accessories | PARKTRONICS AND MIRRORS — Rear parktronic • Front parktronic • Combined parktronic • Rear-view mirrors  
• Accessories | HEATING AND COOLING — Seat heaters • Mirrors heaters • Screen-wipers heaters • Engine heaters • Auto-refrigerators • Air conditioning units • Accessories | TUNING — Vibro-isolation  
• Noise-isolation • Tint films • Accessories | ACCESSORIES — Radar-detectors • Handsfree, Bluetooth • Windowlifters • Compressors • Beeps, loudspeakers • Measuring instruments • Cleaners • Car seats  
• Miscellaneous | MOUNTING — Installation kits • Upholstery • Grilles • Tubes • Cable and wire • Tools • Miscellaneous | POWER — Batteries • Converters • Start-charging equipment • Capacitors  
• Accessories | MARINE AUDIO AND ELECTRONICS — Marine receivers • Marine audio speakers • Marine subwoofers • Marine amplifiers • Accessories | CAR CARE PRODUCTS — Additives • Washer fluid •  
Care accessories • Car polish • Flavors • Adhesives and sealants | LIQUID AND OIL — Motor oil • Transmission oil • Brake fluid • Antifreeze • Technical lubricant



In store "130" you can find and buy almost all necessary goods for your auto in Kyiv and other cities, delivery by ground and postal services. Our experienced consultants will provide you with exhaustive information and help you to chose the very particular thing. We are waiting for you at the address

<https://130.com.ua>

# AVAPOW

## Portable Car Jump Starter User Manual

Model: A58

EN

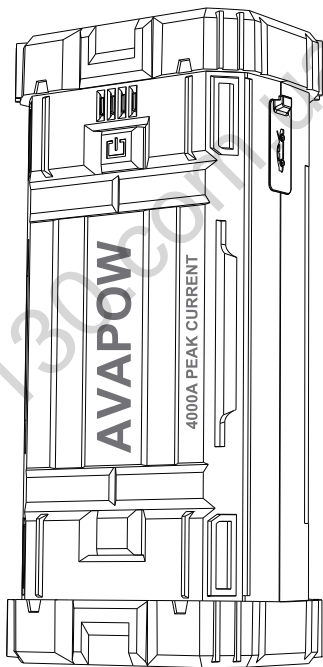

Autogoods "130"

130.com.ua



**Friendly Tips:**

Please carefully read the instruction manual and use product correctly based on the instruction manual so that you can be familiar with the product more conveniently and quickly!

Perhaps there is small difference between the photo and the actual product, so please turn to the actual product for detail information.

130.com.ua

## What's in the Box

- AVAPOW A58 jump starter x1
- Intelligent battery clamps with starter cable x1
- High quality type-C cable x1
- Cigarette lighter converter x1
- Jump starter carry case x1
- User-friendly manual x1

## Product Diagrams

- ① Power button
- ② USB 1: 5V /3A 9V /2A 12V /1.5A
- ③ USB 2: 5V / 2.4A
- ④ EC5 output / dust cover
- ⑤ Type C input: 5V /3A 9V /2A 12V /1.5A
- ⑥ DC output: 12V/10A
- ⑦ LED Light

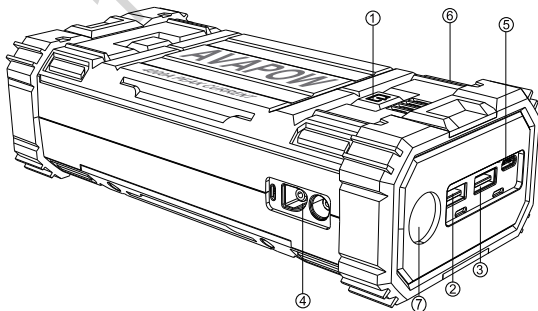

Autogoods "130"

## Specifications

Cycle life	>1000 times
EC5 output	12V / 4000A maximum starting power (max.)
USB1 output	5V/3A 9V/2A 12V/1.5A
USB2 output	5V/2.4A
Type-C input	5V /3A 9V /2A 12V /1.5A
DC output	12V/10A
Charging time	Type-C at 5V / 3A: 4H
LED Light	White: 1W
Working temperature	-10°C~ 60°C
Storage temperature	-10°C~ 60°C
Product accessories	Type-C line, start clamp, cigarette lighter converter, jump starter carry case, user manual

## Charge the Jump Starter Battery

### Charging with an AC adapter (**AC adapter is not included**).

1. Connect the battery input with Type-C USB cable.
2. Connect the USB cable to AC adapter.
3. Plug the AC adapter into a power source.

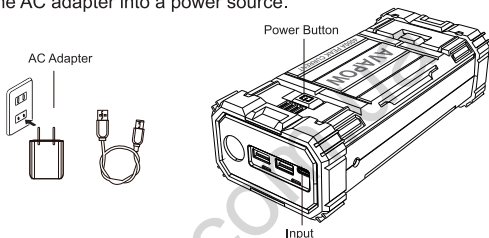

### Charge with a Car Charger (**Note: The car cigarette lighter is not included in the package**).

1. Connect the battery input with car cigarette lighter
2. Plug the charger into the car cigarette lighter hole

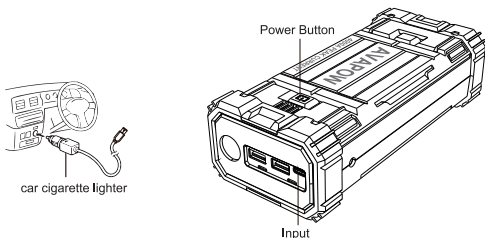



## How to Jump Start Your Vehicle



This unit is designed for jump starting 12V car batteries. Do not attempt to jump start vehicles with a higher battery rating, or different voltage. If the vehicle isn't started immediately, Please wait for 1 minute to allow device to cool down. Do not try to restart the vehicle after three consecutive attempts as this may damage the unit. Check your vehicle for other possible reasons why it can't be restarted.

### Operating Instructions:

Ensure this jump starter batteries has at least 50% or more capacity.

### How to Jump Start a Car?

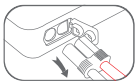
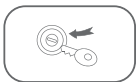
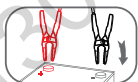
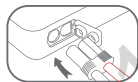

#### First step:

Connect the jumper cable to the jump starter. If the indicator light of jumper cable is blue, the clamp cable is in standby status.

#### Second step:

Connect the clamp to the car battery. Connect the red clamp cable to the positive and the black clamp cable to the negative. Please avoid reverse connection.

#### Third step:

When the indicator light of jumper cable is green, you can try to start your vehicle.

#### Fourth step:

After jump-starting the engine, remove the battery clamp from the car battery, then remove the clamp plug from the jump starter.

## Abnormal Indication of Jumper Clamp

LETTER	STAND FOR	SOLUTION
LC	Low Capacity	Please charge jump starter
RC	Reverse Connection	Please exchange positive and negative poles of the jumper clamp
HT	High Temperature	Please wait 5 mins before starting the car

 Forbid to use this clamp in an environment full of flammable gas.

## Jumper Clamp Indicator Instruction

STATUS	TECHNICAL PARAMETER	DESCRIPTION	SOLUTION
<p>Standby indication</p> 	<p>Blue light</p>	<p>Jump cables connect to jump starter, then <b>blue light</b> on</p>	<p>/</p>
<p>Automatic conduction status indicator (ready to jump start your car)</p> 	<p>Green light</p>	<p>Jump cables connect to the car battery after connecting the jump starter, then <b>green light</b> on</p>	<p>/</p>
<p><b>Force start function</b></p> 	<p>Start the car within 30s</p>	<p>If the above operations cannot start your car, please use the forced start function</p>	<p>Ensure the correct connection of clamps before using force start function, long press <b>the force start button</b> for 3 seconds until <b>green light</b> on</p>

PROTECTION	TECHNICAL PARAMETER	DESCRIPTION	SOLUTION
Reverse connection protection	RC	Wrong connection between jump cable and car's positive and negative poles. The <b>RC red light</b> stays on	Keep the correct connection, the positive pole (red) and the positive pole are connected, the negative pole (black) and the negative pole are connected
High temperature protection	YES	The <b>HT red light</b> stays on and beep long alarm sound; Cut off voltage output	Automatically recover when the temperature drops
Start timeout protection	40S±5S	Automatically enter the standby state after more than 40 seconds and The <b>LED blue light</b> stays on	You can use it again after disconnecting for a minute
Input low capacity protection	13.5V±0.5V	When it is detected that the power of the EC5 port is lower than 13.5V, there is no output at this time, the <b>LC red light</b> stays on and beep long alarm sound	Please charge jump starter
Short circuit protection	YES	No response	Please use the positive and negative poles of jump cables to connect the positive and negative poles of the car's engine to try to start your car

## How to Charge a Mobile Phone or Digital Products?



With A58 powerful capacity and two USB output ports (one is 5V/9V/12V USB quick charge) , it can full charge your smartphones and tablets up to 75% faster than a standard charger. And you can charge two devices at the same time using the powerbank.

### DC & USB Power Supply

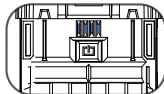
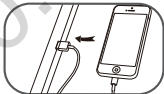
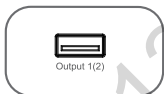

#### First step:

Plug the USB port of the charging cable into the product USB

#### Second step:

Insert the other side into the input port of the mobile phone

#### Third step:

When connected OK, press the power button, then you can use it to charge now

# LED Flashlight



1. Long press the Power button for 3 seconds to turn on the flashlight. The BATTERY CAPACITY indicator lights on. And long press again for 3 seconds to switch the device off completely. If no device is connected to the device, it is automatically switched off.

2. In light mode, e.g. when the LED flashlight is on, short press the Power button to scroll through the lighting, SOS, Strobe. The flashlight offers more than 35 hours of continuous use when fully charged.

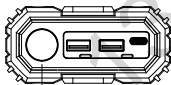

LED Flashlight

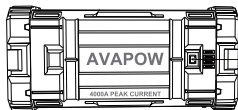

Power button

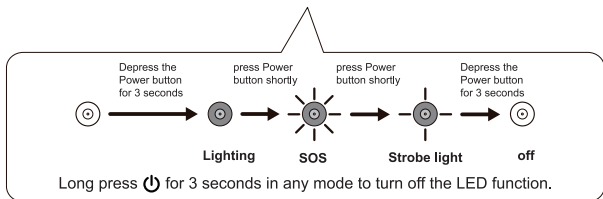



## **Dangerous Warning and Caution in Handing the Battery**

1. Never short circuit the jump starter by connecting the Red and Black clamps.
2. Do not disassemble the jump starter.
3. When children use this product, please operate under the guidance of parents.
4. Store in a dry place, do not expose to damp conditions or near corrosive materials.
5. If the jump starter expands, leakage or peculiar smell was found, stop use immediately.
6. Please use this jump starter at normal temperature and be far away from too wet, too hot and fire.
7. Do not start the vehicle continuously, between starting twice you should allow an interval of at least 30 seconds to 1 minute.
8. When the battery power is less than 10%, do not use the jump starter as it will damage the unit.
9. Before first use, please charge it for 3 hours or more.

130.com.ua



130.com.ua