



PHONES

0 (800) 800 130
(050) 462 0 130
(063) 462 0 130
(067) 462 0 130

130
COM.UA

Internet store of
autogoods



SKYPE

km-130

CAR RECEIVERS — Receivers • Media receivers and stations • Native receivers • CD/DVD changers • FM-modulators/USB adapters • Flash memory • Facia plates and adapters • Antennas • Accessories |
CAR AUDIO — Car audio speakers • Amplifiers • Subwoofers • Processors • Crossovers • Headphones • Accessories | TRIP COMPUTERS — Universal computers • Model computers • Accessories |
GPS NAVIGATORS — Portable GPS • Built-in GPS • GPS modules • GPS trackers • Antennas for GPS navigators • Accessories | VIDEO — DVR • TV sets and monitors • Car TV tuners • Cameras • Videomodules
• Transcoders • Car TV antennas • Accessories | SECURITY SYSTEMS — Car alarms • Bike alarms • Mechanical blockers • Immobilizers • Sensors • Accessories | OPTIC AND LIGHT — Xenon • Bixenon • Lamps
• LED • Stroboscopes • Optic and Headlights • Washers • Light, rain sensors • Accessories | PARKTRONICS AND MIRRORS — Rear parktronic • Front parktronic • Combined parktronic • Rear-view mirrors
• Accessories | HEATING AND COOLING — Seat heaters • Mirrors heaters • Screen-wipers heaters • Engine heaters • Auto-refrigerators • Air conditioning units • Accessories | TUNING — Vibro-isolation
• Noise-isolation • Tint films • Accessories | ACCESSORIES — Radar-detectors • Handsfree, Bluetooth • Windowlifters • Compressors • Beeps, loudspeakers • Measuring instruments • Cleaners • Car seats
• Miscellaneous | MOUNTING — Installation kits • Upholstery • Grilles • Tubes • Cable and wire • Tools • Miscellaneous | POWER — Batteries • Converters • Start-charging equipment • Capacitors
• Accessories | MARINE AUDIO AND ELECTRONICS — Marine receivers • Marine audio speakers • Marine subwoofers • Marine amplifiers • Accessories | CAR CARE PRODUCTS — Additives • Washer fluid •
Care accessories • Car polish • Flavors • Adhesives and sealants | LIQUID AND OIL — Motor oil • Transmission oil • Brake fluid • Antifreeze • Technical lubricant



In store "130" you can find and buy almost all necessary goods for your auto in Kyiv and other cities, delivery by ground and postal services. Our experienced consultants will provide you with exhaustive information and help you to chose the very particular thing. We are waiting for you at the address

<https://130.com.ua>

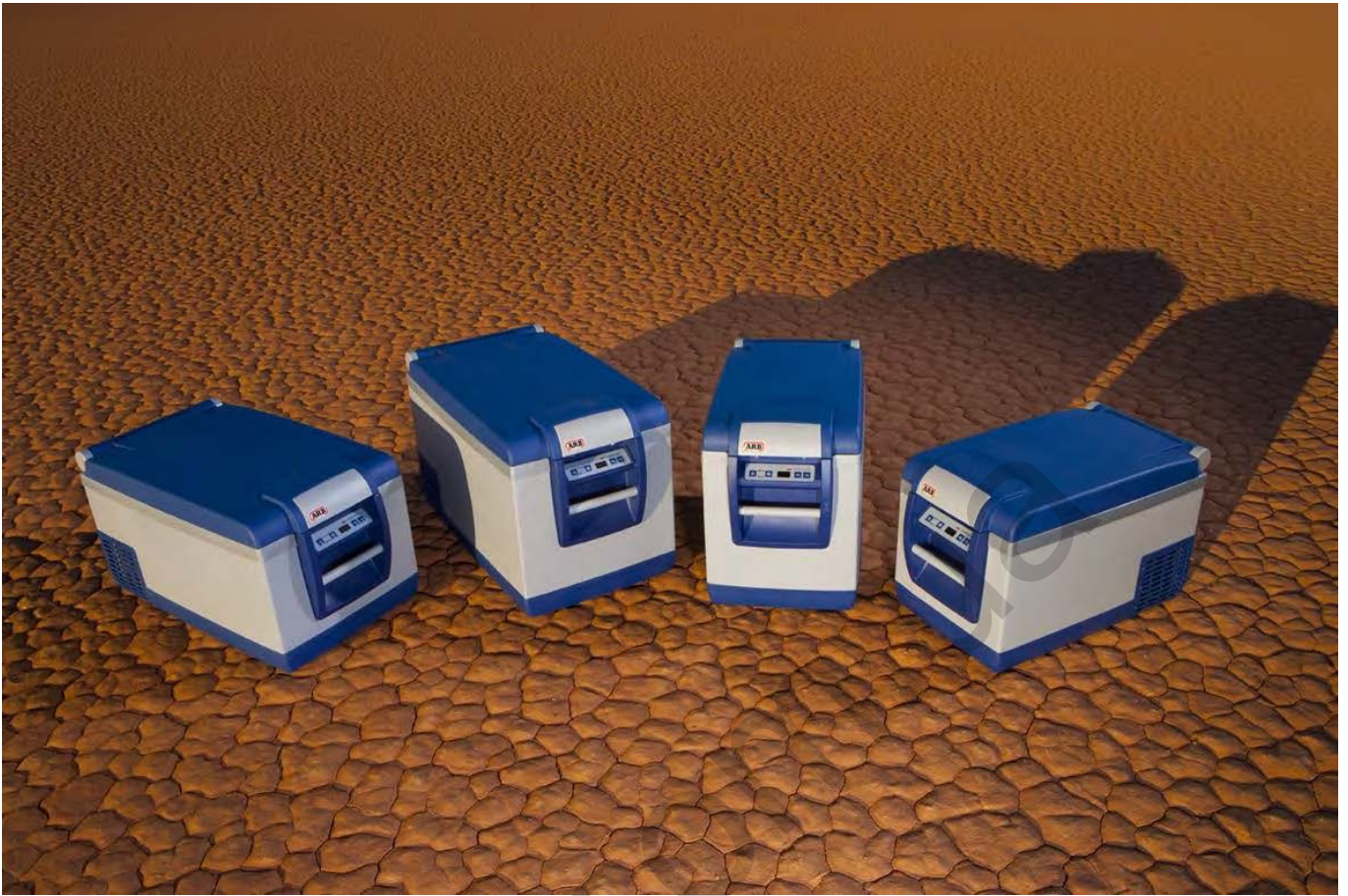

ARB FRIDGE FREEZER SERVICE MANUAL

Model	47L(50 qrt)	35L(37 qrt)	60L(63 qrt)	78L(82 qrt)
Type	10800010	10800020	10800030	10800040
Date	December 2014			

TABLE OF CONTENTS

1	INTRODUCTION	2
1.1	General information	2
1.2	How to use this manual	2
1.3	Contact information	2
2	WARRANTY	3
2.1	ARB Fridge Freezer Limited Warranty	3
2.2	Warranty procedure for service agents	4
2.3	Warranty Approval Form	5
3	STANDARD SERVICE/WARRANTY TIMES	6
4	SPARE PARTS	7
4.1	Spare parts list	7
4.2	Spare parts exploded drawing	8
4.3	Minimum stocked spare parts	9
5	TOOLS REQUIRED	10
5.1	Basic servicing	10
5.2	Servicing the refrigeration system	10
6	TROUBLESHOOTING	11
6.1	Check (diagnosis) lights	11
6.2	DC Power Supply	12
6.3	AC Power Supply	16
6.4	Cooling	17
6.5	General	20
6.6	Battery Protection Settings	21
7	FAULT FINDING FLOW CHARTS	22
7.1	Fridge will not run on 100-240V AC power	22
7.2	Fridge will not run on 12/24V DC power	23
8	CHECKS AND TESTS	24
8.1	Vehicle wiring system	24
8.2	Test compressor control unit – 12/24V DC	27
8.3	Test main circuit board – 100-240V AC	29
8.4	Test compressor control unit – 100-240V AC	31
8.5	Test compressor	33
8.6	Test thermistor	34
8.7	Adjust internal temperature correlation	36
9	SERVICE	37
9.1	Control panel circuit board – Replace	37
9.2	Rear Cover – Remove and Refit	39
9.3	Compressor control unit - Replace	40
9.4	Main circuit board - Replace	42
9.5	Rear Cover – Replace	44
9.6	Cooling fan - Replace	47
9.7	Latch assembly- Replace	49
9.8	Front handle assembly - Remove and Refit	50
9.9	Rear handle assembly – Remove and Refit	52
9.10	Light globe - Replace	54
9.11	Light housing - Replace	55
9.12	Plug fuse (12/24V DC)- Replace	56
9.13	Device fuse (100-240V AC) - Replace	57
9.14	DC power socket - Replace	58
9.15	AC power socket - Replace	59
9.16	Rubber feet – Remove and Refit	60
9.17	Compressor mounting feet – Replace	61
9.18	Compressor mounting base - Replace	63
9.19	Lid seal – Remove and Refit	65
9.20	Lid hinge assembly- Service	66
9.21	Cabinet hinge assembly- Service	67
9.22	Thermistor – Replace	68
9.23	Improving performance with AM radios	71
9.24	Basket retention	73
10	SERVICE BY REFRIGERATION MECHANIC	74
10.1	Compressor recharge information	74
10.2	Leaks in the refrigerant system	74
11	WIRING	75
11.1	Wiring diagram-	75
11.2	Wiring schematic	77
12	PRODUCT IMPROVEMENT CHANGE LOG	78
12.1	Definition of change:	81
12.2	Superseded products:	82

1 INTRODUCTION

1.1 General information

This manual is for the sole use of ARB approved repairers and provides information on servicing the ARB Fridge Freezer (types 10800010, 10800020, 10800030, 10800040). The part numbers covered by this manual include 10800XX1, 10800XX2, 10800XX3, 10800XX4, 10800XX5, 10800XX6 and 10800XX7 where XX represents the applicable fridge volume in litres eg 35, 47, 60 or 78.

Deviation from the directions given in this manual are not permitted without the express permission of the ARB Fridge Freezer Product Manager or the ARB Warranty Manager.

If you have any queries about servicing an ARB Fridge Freezer, please contact ARB using the contact details below.

This manual makes reference to working with mains power in the range from 100-240V AC. All electrical work of this nature must be carried out by a qualified electrician.

This manual makes reference to working with the refrigeration system of the fridge freezer. All work involving the refrigeration system must be carried out by a qualified refrigeration mechanic.

Please note that safe working practices must be exercised while performing any work on an ARB Fridge Freezer.

1.2 How to use this manual

This manual has been developed as an electronic resource. To navigate through this manual, click on the [blue underlined](#) reference links.

Throughout this manual, reference is made to replacement parts. All spare parts are available from ARB. A complete list of spare parts and corresponding part numbers is given in section [4.1](#) of this manual. Please note that individual part numbers are not listed elsewhere within this manual.

The following terms are used throughout this manual:

CAUTION: These are instructions given to prevent damage or accidents.

HINT: These are helpful suggestions to aid the servicing procedure.

NOTE: These are details which may further clarify a situation.

WARNING: These are safety warnings. Failure to observe these instructions can cause personal injury or damage to the fridge.

1.3 Contact information

ARB 4x4 ACCESSORIES
Corporate Head Office

42-44 Garden St
Kilsyth, Victoria
AUSTRALIA
3137

Tel: +61 (3) 9761 6622
Fax: +61 (3) 9761 6807
Web: www.arb.com.au

Australian enquiries
North and South American enquiries
Other international enquiries
European Enquiries

sales@arb.com.au
sales@arbusa.com
exports@arb.com.au
purchasingeu@arb.com.au

2 WARRANTY

2.1 ARB Fridge Freezer Limited Warranty

ARB Corporation Ltd's Fridge Freezers are warranted to be free from material and workmanship defects for a period of thirty six (36) months from the date of initial retail purchase.

ARB Corporation Ltd's obligation under the warranty shall be limited to repairing, replacing or crediting at its option any part found to be defective due to faulty workmanship or materials at time of manufacture.

The warranty does not cover:

1. Light globes after 3 months from the initial purchase date.
2. Damage caused as a result of a connection to an incorrect or fluctuating voltage supply.
3. Damage which in the opinion of ARB is caused by faulty installation, normal wear and tear, misuse, water, dirt, neglect, modification made during installation, accident or other similar causes.
4. Removing screws or otherwise opening the outer case, control panel or tampering with the working components of the fridge by any non-authorized ARB repairer.

ARB does not accept responsibility for:

1. Liability in respect to loss or expenses arising from the malfunction of this appliance.
2. Repairs or modifications to an appliance that have been carried out by a non-authorized ARB Service Outlet or person.
3. Transport charges or damage which may be incurred during transit to or from an authorized ARB Service Outlet.

It is the responsibility of the owner to deliver and pick up the appliance from the place of service.

ARB reserves the right to change the warranty conditions at any time by public notice and by attaching a clear change of warranty terms and conditions notice to the product visible at time of purchase. No party other than ARB Corporation Ltd is authorized to change the terms or conditions of this warranty.

Subject to conditions as defined by the Australian Trade Practices Act 1974 (as amended). There are no other warranties either expressed or implied, which extend beyond those set forth in the preceding paragraphs.

2.2 Warranty procedure for service agents

The following procedure should be followed when processing a warranty claim.

1. Make sure that the customer has completed the non-warranty checklist as listed in the warranty statement that was supplied with the fridge freezer.
2. The Fridge Freezer should be received with all components, including all power leads. A physical inspection of the unit should be conducted to ascertain whether there is any damage (eg: scratches, dents, stain, etc), and documented on the application.
3. Assess the fridge to identify the fault(s).
4. Complete a copy of the warranty claim form (refer to section [2.3](#)) and forward it to your regional ARB Office. To be processed, the form must include the customer's details, serial number, a description of the fault, and the parts required.

NOTE: A copy of the purchase receipt must be submitted with the claim.

5. ARB will assess the claim and if approved will dispatch the required parts as soon as practical at no charge to the repairer. If the claim is not approved, ARB will contact the repairer. ARB will also issue the repairer with a Warrant Claim Number and provide any special instructions for repair or return of faulty parts.
6. The repairer shall replace the specified components as per the service manual and test the ARB Fridge Freezer prior to its return to the customer. It is the responsibility of the repairer to warrant the workmanship of the repair for the minimum period as set out in legislation for the jurisdiction in which the ARB Fridge Freezer has been repaired, or if no period is specified, for a minimum of 90 days.
7. Send an invoice that references the Warranty Claim Number to your regional ARB Office for processing. Any variance to the warranty times as stated in this manual must be approved by ARB.

EXCLUSIONS:

Refer to the Warranty Statement supplied with the fridge.

ARB will not accept liability for transport of the ARB Fridge Freezer to or from the service agent.



ARB Fridge Freezer

2.3 Warranty Approval Form

FRIDGE FREEZER

(ARB Use Only)

Authorised By: _____ Claim Number

Service Agent: _____	Contact: _____
Address: _____	Phone: _____
	Fax: _____
Date In: _____ Date Out: _____	Job No: _____

CUSTOMER DETAILS

Name: _____ Phone: _____ BH: _____
 Address: _____ MOB: _____
 _____ P/Code _____ Cust Signature: _____

***NOTE – Pre Warranty Inspection to be completed by customer prior to initiating claim (refer Warranty & Service booklet)**

 Condition Assessment (mark scratches, dents, etc)	FRIDGE DETAILS		
	Model No: _____	Serial No: _____	
	Purchase Date: _____	Receipt No: _____	
	Purchased From: _____	Copy of Receipt Attached	YES / NO

Notes: _____

Returned with: (Tick)	12V Lead	240V Lead	Fridge Bag	Other
-----------------------	----------	-----------	------------	-------

CUSTOMERS DESCRIPTION OF FAULT

REPAIRERS ASSESSMENT

PARTS REQUIRED

REPAIR TIME (As Per Service Manual)		TOTAL LABOUR COST	\$	*Please Note An invoice quoting the Claim No. must be submitted to initiate payment of labour costs
--	--	-------------------	----	---

(ARB Use Only) Replaced parts to be returned for assessment	YES / NO
---	----------

Within Australia Fax to (03) 9721 9096

3 STANDARD SERVICE/WARRANTY TIMES

WORK REQUIRED	INDIVIDUAL WARRANTY TIME*
Compressor – remove and replace **	
Condenser – remove and replace **	
Compressor control unit – remove and replace	1.0 hours
Compressor mounting base –remove and replace	1.5 hours
Control panel circuit board – remove and replace	1.0 hours
Device / plug fuse - replace	0.25 hours
Fan – remove and replace	1.0 hours
Handle assembly – remove and replace	1.0 hours
Hinge assembly – service	0.25 hours
Inlet power socket - remove and replace	0.75 hours
Latch assembly – remove and replace	0.25 hours
Lid - replace	0.25 hours
Lid seal – remove and replace	0.25 hours
Light globe – replace ***	0.25 hours
Light housing - replace	0.25 hours
Main circuit board – remove and replace	1.0 hours
Power cable – check and replace	0.25 hours
Refrigerant blockage or leak **	1.75 hours
Rubber feet – remove and replace (x 4)	0.25 hours
Thermistor - replace	1.0 hours

* Some warranty times can be negotiable due to unforeseen complexities. Any extension to the standard warranty times must be authorised by ARB.

** These parts are not considered serviceable items. Complete fridge replacement is required.

*** Light globes are only covered under warranty for the first 3 months after the initial purchase date.

ARB will not pay for the removal or replacement of a fridge freezer that has been built in, unless authorisation is given by the ARB.

The warranty labour rate paid will be based on the average refrigeration service rate for the region of the repairer.

Calculating total warranty time

The table above list warranty times for the service of individual components.

If a single item is serviced or replaced and the warranty time is less than 0.5 hours, ARB will accept a total warranty time of 0.5 hours. This will allow for assessment and administration of the warranty claim.

If multiple components are to be serviced or replaced under the same warranty claim, the full individual warranty time will not be paid to replace each component. The total warranty time paid will be calculated as follows:

Individual warranty time	→	<i>For component being replaced with the longest individual warranty time.</i>
+		
0.5 hours	→	<i>For each additional component being replaced with an individual warranty time greater than 0.5 hours</i>
+		
Individual warranty time	→	<i>For each additional component being replaced with an individual warranty time less than 0.5 hours</i>

4 SPARE PARTS

4.1 Spare parts list

The items in the following table correspond with the items on the exploded diagram in section 4.2.

Item	Description	Qty
1	Lid	1
2	Cap - Hinge	2
3	Pin - Hinge	2
4	Spring Kit - lid hinge	2
5	Socket kit - lid hinge	2
6	Handle assy Kit – Rear (inc. item 8)	1
7	Screw Kit - Rear handle assy (pack of 8)	1
8	Plug Kit - Rear handle assy	1
9	Condenser	1
10	Screw Kit - Condenser and Fan	1
11	Fan - Brushless	1
12	Compressor BD35F	1
	Compressor BD50F	1
13	Control unit - Danfoss	1
14	Screw Kit - Mounting base (pack of 10)	1
15	Mounting base	1
16	Mounting Kit – Compressor (pack of 4)	1
17	Screw Kit - Rear cover (pack of 12)	1
18	Power Socket - DC	1
19	Power Socket - AC	1
20	Decal - power panel	1
21	Power Cord - DC	1
22.1	Power Cord AC, Plug I, Suit 10800xx1	1
22.2	Power Cord AC, Plug B, Suit 10800xx2	1
22.3	Power Cord AC, Plug F, Suit 10800xx3	1
22.4	Power Cord AC, Plug D, Suit 10800xx4	1
22.5	Power Cord AC, Plug G, Suit 10800xx5	1
23	Cover - AC power socket	1
24	Screw Kit - Main circuit board (pack of 3)	1
25	Cable Clip - AC	1
26	Circuit Board (main) with Insulator (section 12.)	1
	Circuit Board (main) with insulator for remote (section 12.)	1
27	Cover - Rear vent	1
28	Rubber Foot Kit	4
29	Plug Kit - Front handle assy	1
30	Screw Kit - Front handle assy	1
31	Handle assy Kit - Front (inc. item 29)	1
32	Support - Control panel (see section 12.)	1
33	Thermistor	1
34	Cabinet and Evaporator	1
35	Screw Kit - Latch (pack of 3)	1
36	Latch Assy	1
37	Screw Kit - Control panel	1
38	Touch Pad (small) - Control panel (see section 12.)	1
	Touch Pad (lge) - Control panel (see section 12.)	1
39	Backing Plate - Control panel	1
40	Circuit Board - Control panel (see section 12.)	1
	Circuit Board - Control panel for remote (see section 12.)	1
41	Light Bulb LED	1
42	Housing Kit - light	1
43	Basket (without divider)	1
44	Drain Plug Kit	1
45	Divider - Basket	1
46	Seal - Lid	1

35L(37q)	47L(50q)	60L(63q)	78L(82q)
Part Number			
10910003		10910047	
10910002		10910050	
10910001			
10910051		10910052	
10910053			
10910055	10910054	10910055	10910054
10910056			
10910058	10910057	10910058	10910057
10910010			
10910059			
10910009			
40910008			
			40910046
10910007			
10910060			
10910061		10910062	
10910063			
10910064			
10910018			
10910019			
10910017			
10910076			
10910011			
10910012			
10910013			
10910014			
10910015			
10910020			
10910065			
10910021			
10910066			
10910077			
10910022		10910045	
10910067			
10910068			
10910069			
10910070			
	40910023		
10910027			
10910042	40910029	40910043	40910044
10910071			
10910072			
10920019			
	40910026		
10910041			
10910025			
10910048			
10910078			
10910028			
10910074			
10910037	10910006	10910038	10910039
10910075			
10910005		10910036	
10910004		10910049	

NOTES:

- Quantity column indicates maximum number of individual items per service repair.
- The part number given is for singular units unless otherwise stated in the item description.
- Drawings are indicative only, product appearance may change slightly.
- 423456 indicates "use to depletion" product, check stock with your ARB store.

The following items are not illustrated in section 4.2.

Item	Description	Qty
	DC Plug adaptor - Red collar	1
	Label - lid instructions	1
	Instruction Manual	1
	Fuse AC 100-240V T2 4	1
	Fuse DC ceramic 12/24V T8A 32V (see section 12.)	1
	Fuse DC Glass 12/24V 15Amp type 3AGA	1
	Clear Protective Cover	1
	Cover Socket – Rear Panel for wireless transmitter	1
	Lead PCB - Main PCB to wireless transmitter	1
	Mount Bracket –Fridge Remote Display	1
	DC Lead - Fridge Remote Display	1

Part Number
40910030
10910031
10910032
10910033
10910034
10910035
10910079
10910080
10910081
10910082

4.2 Spare parts exploded drawing

The items in the following exploded diagram correspond with the items in the table in section 4.1.

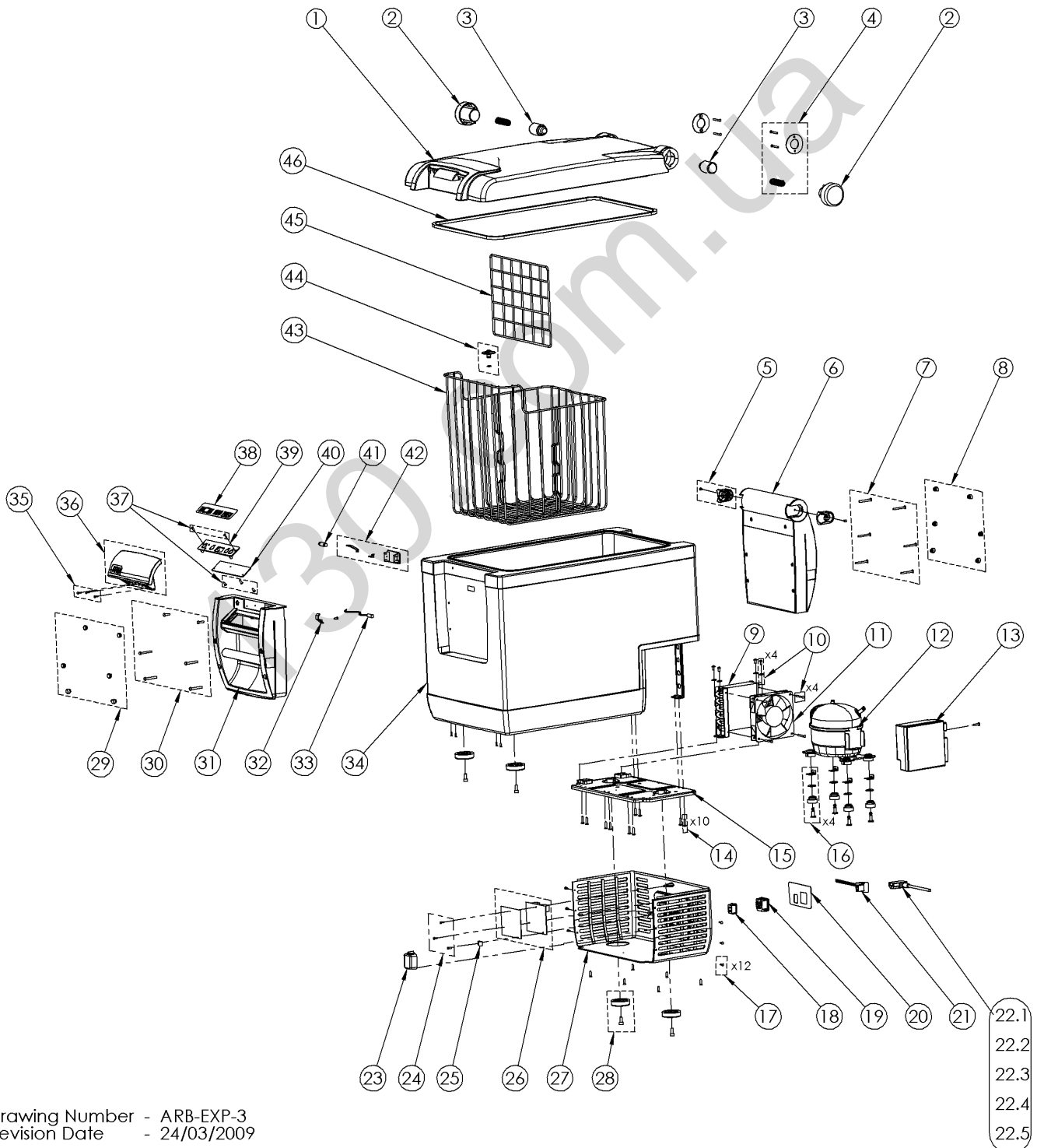

Drawing Number - ARB-EXP-3
 Revision Date - 24/03/2009

4.3 Minimum stocked spare parts

ARB recommends that the following parts be stocked by all ARB fridge freezer service agents. As these parts are consumed, they should be replaced as soon as possible to ensure that all items are on hand when required. For replacement parts, contact your regional ARB office.

Parts not listed in the table below can be ordered from ARB as required.

The item numbers in the table below correspond with the item numbers in the table in section [4.1](#) and the exploded drawing in section [4.2](#).

ARB Part Number	Description	Item
10910007	CONTROL UNIT - DANFOSS	13
10910009	FAN - BRUSHLESS	11
10910048	CIRCUIT BOARD - CONTROL PANEL	40
10910078	CIRCUIT BOARD - CONTROL PANEL for REMOTE	40
10910041	TOUCH PAD - CONTROL PANEL	38
10910066	CIRCUIT BOARD – MAIN	26
10910077	CIRCUIT BOARD – MAIN for REMOTE	26
10910076	POWER CORD DC	21
10910028	LIGHT BULB LED	41
10910033	FUSE AC 100-240V T2 4 Amp –F4L250V	--
10910027	THERMISTOR	33
10910051	SPRING KIT – LID HINGE 35/47	4
10910052	SPRING KIT – LID HINGE 60/78	4
10910035	PROTECTIVE CLEAR COVER (see section 12)	--
10910072	LATCH ASSEMBLY	36
10910075	DRAIN PLUG KIT	44
10910037	BASKET 35L	43
10910007	BASKET 47L	43
10910038	BASKET 60L	43
10910039	BASKET 78L	43

NOTE: The touch pad (p/n 10910041) is required when servicing or replacing the control panel circuit board Refer to section [12](#) .

The protective clear cover (p/n 10910035) should be fitted to any fridge which may be exposed to weather.

5 TOOLS REQUIRED

5.1 Basic servicing

The following tools will be required to perform general non-refrigeration based servicing of the fridge.

Basic tool kit

- Phillips head screw drivers (various sizes)
- Flat blade screw drivers (various sizes)
- Needle nosed pliers
- Wire (side) cutters
- Vice grips
- Sharp knife
- 5 mm hex key
- Cable ties
- 12V power supply
- Multimeter (with the following ranges)
 - DC voltage (0 - 24V)
 - AC voltage (100 - 240V)
 - Resistance (0.5 Ω – 50 k Ω)
 - Temperature +10°C (+50°F) to -18°C (0°F)
- Jumper cable
 - Short length of insulated wire terminated with spring loaded clips or push-on connectors at each end.

The following tools will be required to perform specific non-refrigeration based servicing of the fridge

Check vehicle wiring (refer to section [8.1](#))

- DC Voltage Drop tester (available from ARB – part # 10910040)

Remove front or rear handle assembly (refer to sections [9.8](#) and [9.9](#))

- Self tapping screws - approximately 3.5 mm (6g) x 25 mm (1") long
- Drill & drill bit to suit pilot hole for self tapping screw (approximately 3 mm / 1/8")

Replacement of power sockets (refer to sections [9.14](#) and [9.15](#))

- Soldering iron & solder
- Heat shrink tubing (to suit 3 mm insulated wire) & heat gun

Service of hinge assembly (refer to section [9.20](#))

- Paraffin based dry lubricant e.g. Dri-Lube by Goss Products



Replace serviceable thermistor (refer to section [9.22](#))

- Heat transfer paste (available from Jaycar p/n NM-2012)

Fitting braided earth strap (refer to section [9.23](#))

- Crimpers suitable for electrical terminals

5.2 Servicing the refrigeration system

It is expected that a refrigeration mechanic who is servicing the refrigeration system will have the appropriate equipment to pressure test, evacuate and charge the system with the specified refrigerant in accordance with local or State handling practices.

6 TROUBLESHOOTING

6.1 Check (diagnosis) lights

1 x flash every 5 seconds – BATTERY PROTECTION CUT-OUT

The battery protection system has turned the fridge freezer off because low voltage has been detected.

Things to check

- Check that the correct battery protection setting has been selected to suit the customer's requirements.
- Check the vehicle wiring is adequate.
 - For cable lengths up to 6m (20'), ARB recommends a minimum automotive cable size of 6 mm (4.5 mm²).
 - For cable lengths greater than 6m (20'), ARB recommends that you consult a qualified technician for advice on the correct wire size.
- Check that all terminals and joints are clean and in good condition.
- Check that the battery voltage at the socket is above the set cut-out voltage (refer to section [6.6](#)). To ensure that voltage drop is accounted for when measuring this voltage, refer to section [8.1](#).

NOTE: The battery protecting system only controls 12 and 24V DC supplies. To confirm that the fridge freezer is operating correctly, connect the fridge freezer to a standard 100-240V AC supply.

2 x flashes every 5 seconds – FAN OVER-CURRENT CUT-OUT

The control system has turned the fridge freezer off because the fan is drawing more than 0.5 amp while the compressor is running. This could be because the fan is running slowly or not running at all.

Things to check

- Check that the fan is not obstructed or dirty.

3 x flashes every 5 seconds – MOTOR START ERROR

The compressor will not start because the refrigerant system has become unbalanced. This can occur when the power to the fridge freezer is briefly interrupted.

Things to check

- Turn the fridge freezer off and disconnect it from its power supply.
- Allow the fridge freezer to stand for 10 to 15 minutes to allow the system to equalise.
- Reconnect the fridge freezer to the power supply and turn it on.
- Check that the fridge freezer is operating correctly.

4 x flashes every 5 seconds – MINIMUM MOTOR SPEED ERROR

The compressor motor is running below its minimum maintainable speed. This could be because the refrigerant system has been overcharged.

Consult a refrigeration mechanic to check that the system is charged with the correct amount of refrigerant.

5 x flashes every 5 seconds – THERMAL CUT-OUT OF ELECTRONIC UNIT

The fridge freezer has stopped operating because the control unit has become too hot.

Things to check

- Check to ensure that there is adequate ventilation around the control unit and the compressor.
- Check that the fan is operating correctly. The fan must always be running when the compressor is running.
- The fridge freezer may be operating in extremely high ambient temperatures. For example in a sealed stationary vehicle that is parked in the direct sunlight. Try to improve the ventilation around the fridge freezer or shield it from direct sunlight.

TROUBLESHOOTING

6.2 DC Power Supply

Symptom	Possible Cause(s)	Suggested Action(s)
<p>No power to fridge when using a 12/24V DC power supply.</p> <p>Interior light does not work.</p>	Interior light globe has blown.	Replace light globe (refer to section 9.10).
	12/24V DC plug fuse has blown.	Replace 12/24V DC plug fuse (refer to section 9.12). The correct rating is T8 Amp 32V.
	Fault with 12/24V DC fridge power lead.	Check continuity of lead from plug to socket. Replace lead if faulty or damaged.
	Poor connection of plug to socket in back of fridge.	Check that plug is correctly installed into socket in back of fridge. NOTE: A poor connection can cause high resistance and a large voltage drop. This can cause the battery protection system to activate prematurely.
	No power to supply socket from power source (eg vehicle battery).	Check that vehicle wiring is correct and that power is available at the outlet socket.
	The DC supply voltage is below the minimum voltage needed to operate the fridge.	Connect the fridge to a 12 or 24V DC power supply. Check the supply voltage. NOTE: The compressor control unit and digital display will not operate if the supply voltage is below approximately 7V DC.
	The polarity of the fridge power circuit is wired incorrectly. This means the positive (+) and negative (-) wires are connected back to front.	Check the DC wiring circuit to ensure the polarity (“+” and “-”) is correct. NOTE: The compressor control unit has inbuilt polarity protection and will not function if the polarity is incorrect.
	Poor electrical connection inside the fridge between the power socket and the compressor control unit.	Check connections between the DC socket and the “+” and “-” terminals on the compressor control unit.
Check that approximately 12 or 24V DC is measured at the “+” and “-” terminals.		

TROUBLESHOOTING

DC Power Supply (continued)

Symptom	Possible Cause(s)	Suggested Action(s)
<p>Fridge does not run when using a 12/24V DC power supply.</p> <p>Interior light works.</p>	Power LED is orange. Fridge has reached cabinet temperature and is functioning correctly.	Reduce target cabinet temperature. Power LED will change to green, compressor will start and fridge will start cooling.
	Faulty compressor control unit.	Test compressor control unit (refer to section 8.2). If compressor does not run during test, replace control unit (refer to section 9.3) and repeat test. If compressor still fails to run, test compressor (refer to section 8.5).
	Faulty control panel circuit board.	Test compressor control unit (refer to section 8.2). If control unit is ok, test fridge with new control panel circuit board and replace if necessary (refer to section 9.1).
	Faulty main circuit board.	Test compressor control unit (refer to section 8.2). If control unit is ok, test fridge with new main circuit board and replace if necessary (refer to section 9.4).
	Faulty thermistor.	Test compressor control unit (refer to section 8.2). If control unit is ok, test fridge with new thermistor and replace if necessary (refer to section 9.22).
	Fault within main wiring loom.	Test continuity of wiring loom from main circuit board to control panel circuit board. If fault identified and unrepairable, contact ARB for advice.
	Faulty compressor.	Test compressor (refer to section 8.5). If compressor is faulty, contact a licensed refrigeration mechanic for assistance. <p>NOTE: A faulty compressor is extremely unlikely.</p>
<p>Fridge will not run when DC input voltage exceeds 13.8V (eg. When vehicle is running).</p>	Faulty main circuit board.	Replace main circuit board (refer to section 9.4) and retest.



TROUBLESHOOTING

DC Power Supply (continued)

Symptom	Possible Cause(s)	Suggested Action(s)
12/24V DC fridge lead plug fuse blows repeatedly.	Fault within 12/24V DC fridge power lead.	Check continuity of lead from plug to socket. Replace lead if faulty or damaged.
	Incorrect fuse used in plug.	Install the correctly rated fuse. The correct rating is T8 Amp 32V (refer section 9.12).
	Short circuit between “+” and “-” terminals on compressor control unit.	Check for short circuits between the “+” and “-” terminals on the compressor control unit.
Compressor stops running, LED display is visible, error light flashes once every 5 seconds.	Compressor has stopped running because battery cut-out voltage has been reached.	Check that correct battery protection setting is selected (refer section 6.6).
		Check that vehicle wiring is adequate. Refer to section 8.1 .
		Check battery voltage and voltage at supply socket. NOTE: Voltage readings must be taken with a load on the circuit to allow for voltage drop within the circuit (refer to section 8.1).
		Check that plug is correctly installed into socket in back of fridge.
		Check that plug is correctly installed into supply socket in vehicle.
		Test fridge on 100-240V AC to confirm correct operation of fridge.
Intermittent power supply to fridge.	Poor connection of plug into socket in back of fridge.	Check that plug is correctly installed into socket in back of fridge.
		Check that the plug makes firm connection with the terminals inside the fridge socket. If fit is loose, test fridge with new power lead. If symptom resolved, replace power lead.
	Poor connection of plug into supply socket (eg vehicle accessories socket).	Check that plug is correctly installed into the supply socket.
	Compressor has stopped running because battery cut-out voltage has been reached.	Check that correct battery protection setting is selected (refer section 6.6).
Check that vehicle wiring is adequate. Refer to section 8.1 .		

TROUBLESHOOTING

DC Power Supply (continued)

Symptom	Possible Cause(s)	Suggested Action(s)
Fridge runs but digital display is not visible.	Faulty control panel circuit board.	Test with new control panel circuit board (refer to section 9.1). If symptom resolved, replace circuit board.
Fridge runs but cannot change target temperature.	Faulty control panel circuit board.	Test with new control panel circuit board (refer to section 9.1). If symptom resolved, replace circuit board.
Fridge does not run, error light flashes twice every 5 seconds	The fan is not connected to the compressor control unit.	Check the fan wiring to ensure the “+ve” and “-ve” fan wires are correctly connected to the compressor control unit (refer section 9.3).
	Faulty fan.	Test with new cooling fan (refer to section 9.6). If symptom resolved, replace fan. NOTE: The fan must be running whenever the compressor is running.
	Faulty compressor control unit.	Test compressor control unit (refer to section 8.2). If symptom resolved, replace control unit (refer to section 9.3).
Interior cabinet light does not work.	Interior light globe has blown.	Replace light globe (refer to section 9.10).
	No power to fridge.	Check that either 12/24V DC or 100-240V AC power is being supplied to the fridge.
	Faulty main circuit board	Test operation of light with new main circuit board (refer section 9.4). If symptom resolved, replace circuit board.
	Faulty light switch	Replace cabinet assembly.
Digital display shows “Err1” 	The thermistor is not correctly connected to the control panel circuit board.	Check connection of thermistor to control panel circuit board.
	Thermistor circuit is ‘open circuit’.	Test thermistor (refer to section 8.6) and replace if necessary.
Digital display shows “Err2” 	Thermistor circuit is ‘short circuit’	Test thermistor (refer to section 8.6) and replace if necessary.
Digital display shows “Err3” 	Faulty control panel circuit board.	Replace control panel circuit board (refer to section 9.1).

TROUBLESHOOTING

6.3 AC Power Supply

Symptom	Possible Cause(s)	Suggested Action(s)
No power to fridge when using a 100-240V AC power supply.	Poor connection of plug to back of fridge.	Check that plug is correctly installed into the socket in back of fridge.
	Device fuse in back of fridge cabinet has blown.	Replace device fuse. Refer to section 9.13 .
	No power to supply socket from AC power source.	Check that there is power to the supply socket from the AC power source. NOTE: If using a poor quality power generator, it is possible that the supply voltage could be above or below the 100-240V AC power range and may not be a pure, non-fluctuating sine wave.
	Poor electrical connection inside the fridge between the AC power socket and the compressor control unit.	Check AC electrical wiring within the fridge. NOTE: All AC electrical work should be carried out by a qualified electrician.
	Faulty main circuit board.	Test main circuit board (refer to section 8.3) and replace if necessary.
		Test with new main circuit board. If symptom resolved, replace circuit board (refer to section 9.4).
Faulty compressor control unit.	Test compressor control unit on AC power (refer section 8.4). Replace if necessary.	
	Test with new compressor control unit. If symptom resolved, replace control unit (refer to section 9.3).	
Device fuse repeatedly blows.	Short circuit in 100-240V AC fridge cable.	Check continuity of lead from plug to socket. Replace lead if faulty or damaged.
	Short circuit between terminals "L" and "N" on compressor control unit.	Check for short circuit between the "L" and "N" terminals on the compressor control unit.
	Unregulated and/or fluctuating power supply. For example <i>From an engine driven generator.</i>	Ensure that the generator has a voltage regulator and is supplying a standard, pure sine wave AC voltage without fluctuation in voltage or frequency NOTE: Ensure that the fridge is turned off before starting or stopping the generator.
	Fault with compressor control unit.	Test with new compressor control unit & replace if necessary (refer section 9.3).

TROUBLESHOOTING

6.4 Cooling

Symptom	Possible Cause(s)	Suggested Action(s)
Fridge does not cool. Compressor run.	Poor ventilation.	Check that there is sufficient clearance around the fridge and that the fan is not obstructed.
	Compressor starts and stops because the battery protection system is active. Error light flashes once every 5 seconds.	Check that the correct battery protection setting is selected (refer section 6.6).
		Check that vehicle wiring is adequate (refer to section 8.1).
	NOTE: In the rear of a vehicle, the customer may be unaware that this is occurring.	
	The lid seal is damaged or missing.	Check seal is installed correctly into lid and it is in good condition. Replace seal if damaged or missing (refer section 9.19).
	Leak in refrigerant system.	Look for visible oil leaks around the refrigeration lines, compressor and condenser. If a leak is detected, contact a qualified refrigeration mechanic for service advice.
If no leak detected, contact a qualified refrigeration mechanic and request that the system is pressure tested.		
Blockage within the refrigeration system.	Contact a qualified refrigeration mechanic for service advice.	
Fridge does not cool. Compressor does not run.	Faulty compressor control unit.	Test compressor control unit (refer to section 8.2) and replace if necessary (refer to section 9.3).
	Faulty control panel circuit board.	Test compressor control unit (refer to section 8.2). If control unit ok, test fridge with new control panel circuit board and replace if necessary (refer section 9.1).
	Faulty main circuit board.	Test compressor control unit (refer to section 8.2). If control unit is ok, test with new main circuit board and replace if necessary (refer to section 9.4).
	Faulty thermistor.	Test compressor control unit (refer to section 8.2). If control unit is ok, test with new thermistor and replace if necessary (refer to section 9.22).
	Faulty compressor. NOTE: A faulty compressor is extremely unlikely.	Test compressor (refer to section 8.5). If compressor is faulty, contact a licensed refrigeration mechanic for assistance.

TROUBLESHOOTING

Cooling (continued)

<i>Symptom</i>	<i>Possible Cause(s)</i>	<i>Suggested Action(s)</i>
Temperature display is not accurate with cabinet temperature.	Time lag has not been allowed for.	Allow the fridge to reach the set temperature and cycle a few times before assessing accuracy of temperature. NOTE: A display temperature within 2-3°C (3.6-5.4°F) of the actual temperature at the base of the fridge is within normal on/off cycle temperature variation.
	Frozen items have been placed directly on top of thermistor.	Rearrange items in fridge so that frozen items are not located directly on top of the thermistor. NOTE: The thermistor is located in the base of the fridge directly under the centre of the plastic liner.
	Internal temperature correlation settings inaccurate.	Adjust the internal temperature correlation setting (refer to section 8.7). NOTE: This should not be necessary unless the thermistor has been replaced.
Items freeze with fridge set to warmest setting.	Faulty thermistor.	Test thermistor (refer to section 8.6) and replace if necessary (refer section 9.22).
	Faulty control panel circuit board.	Test fridge with new control panel circuit board and replace if necessary (refer to section 9.1).
	Faulty main circuit board	Test fridge with new main circuit board and replace if necessary (refer to section 9.4).
Fridge does not reach target temperature.	Fridge is operating at its maximum cooling capacity in extreme ambient temperatures.	The maximum cooling capability of the system is a reduction of 50°C (122°F) below ambient temperature. For example <i>In ambient temperatures above 32°C (73°F), the system may not cool to a cabinet temperature of -18°C (0°F).</i>
Large temperature difference between the top and bottom of fridge.	The temperature within the cabinet will vary as the compressor cycles on and off. The temperature difference will vary depending on factors like how the fridge is loaded and how often it is opened.	Advise the customer that some temperature variation is normal within the fridge. NOTE: The temperature difference can increase as the cabinet temperature decreases.

TROUBLESHOOTING

Cooling (continued)

Symptom	Possible Cause(s)	Suggested Action(s)
Fridge cools but compressor runs continuously.	Poor ventilation.	Check that there is sufficient clearance around the fridge and that the fan is not obstructed.
	Fridge is operating at or near the thermal capacity of system.	The thermal capacity of the system is 50°C (122°F) below ambient temperature.
	The lid seal is damaged or missing.	Check that the seal is installed correctly into the lid and that it is in good condition. Replace the seal if it is damaged or missing (refer section 9.19).
	Faulty thermistor.	Test thermistor (refer to section 8.6) and replace if necessary (refer section 9.22).
	Faulty control panel circuit board.	Test fridge with new control panel circuit board and replace if necessary (refer to section 9.1).
	Faulty main circuit board.	Test fridge with new main circuit board and replace if necessary (refer to section 9.4).
	Insufficient charge of refrigerant in compressor system.	Contact a qualified refrigeration mechanic and request that the system is pressure tested.
	Partial blockage within the refrigeration system.	Contact a qualified refrigeration mechanic for service advice.
Noisy compressor	Compressor is loose or not correctly mounted.	Inspect the compressor to ensure that it is correctly mounted. Replace compressor mounting feet if necessary (refer to section 9.17).
	Noise from inside compressor when fridge experiences high movement and/or vibration .	This noise is normal when the fridge experiences high movement and/or vibration. <i>The Danfoss compressor is built to military specifications and has inbuilt limit stops to prevent damage. Under high movement or vibration, these bump stops are designed to contact the compressor housing to prevent internal damage to the compressor.</i>
	System is low on refrigerant.	Perform checks listed above under "Fridge does not cool. Compressor Runs".
Digital display shows temperature values in the wrong units.	The internal settings within the control panel are incorrect.	Refer to the owners manual for directions on changing temperature units between °C and °F.

TROUBLESHOOTING

6.5 General

Symptom	Possible Cause(s)	Suggested Action(s)
Lid is hard to release from body of fridge.	The hinge assembly has become contaminated with dirt.	Carefully remove the lid from the body of the fridge. Remove any dirt or grit from the hinge sockets and service the hinge assembly (refer to sections 9.20 & 9.21). HINT: Use a thin piece of steel or plastic (eg a 150 mm ruler) to help disengage the hinge pins.
Latch does not easily disengage from lid.	The high quality seal is causing the lid to sit away from the fridge cabinet.	Press down on the lid slightly to help disengage the latch from the lid.
	Faulty latch.	Inspect latch and latch pivot for damage. If necessary, replace latch assembly (refer to section 9.7).
Noisy fan.	Obstruction in fan.	Remove foreign material from the fan and retest system.
	Faulty fan.	Remove fan from fridge and test. If fan is identified as faulty, replace with new fan (refer to section 9.6).
Lid opens during transit.	The latch was not closed correctly.	Advise customer that latch must be correctly closed before transportation.
	Faulty latch.	Inspect latch and latch pivot for damage. If necessary, replace latch assembly (refer to section 9.7).
Lid will not open when fridge is running.	The air inside the fridge has cooled forming a negative pressure within the cabinet. This can occur when the fridge is left running while empty.	Remove the drain plug to allow the pressure inside the cabinet to equalise with the ambient air. Advise customer to remove drain plug from drain if the fridge is to be left running with nothing inside it. HINT: Dislodge the drain plug from the fridge cabinet by pushing it up from under the fridge use a small round rod or similar.
Hinge noisy during operation.	The hinge sockets have become dirty.	Remove lid from body of fridge. Clean hinge sockets. Refer to section 9.20 & 9.21 .



TROUBLESHOOTING

6.6 Battery Protection Settings

The ARB Fridge Freezer is fitted with a battery monitor to control the level of discharge of the supply battery. The battery monitor has three settings; HIGH, MEDIUM and LOW. When set to HIGH, the battery monitor will provide maximum protection for the battery against excessive discharging. When set to LOW, the battery monitor will allow maximum use of the energy stored in the battery. The table below shows the voltage cutout levels for the three battery monitor settings.

	BATTERY MONITOR MODE		
	LOW	MED	HIGH
Switch off voltage – 12V DC	10.1V	11.4V	11.8V
Restart voltage – 12V DC	11.1V	12.2V	12.6V
Switch off voltage – 24V DC	21.5V	24.1V	24.6V
Restart voltage – 24V DC	23.0V	25.3V	26.2V

To change the battery protection level:

- Turn the fridge freezer on.
- Press  three times to display current battery protection setting.
- Press  or  to change the battery protection voltage between High (HI), Medium (nEd) and Low (Lo).
- After 5 to 6 seconds of inactivity, the display will flash twice and return to displaying the current cabinet temperature.

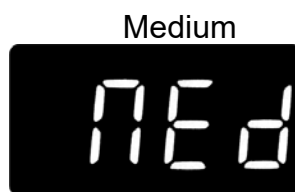
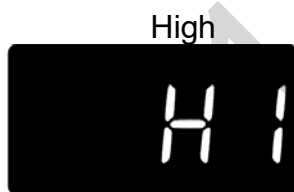

NOTE: The battery protecting system only controls 12 and 24V DC supplies. To confirm that the fridge freezer is operating correctly, connect the fridge freezer to a standard 100-240V AC supply.

7 FAULT FINDING FLOW CHARTS

7.1 Fridge will not run on 100-240V AC power

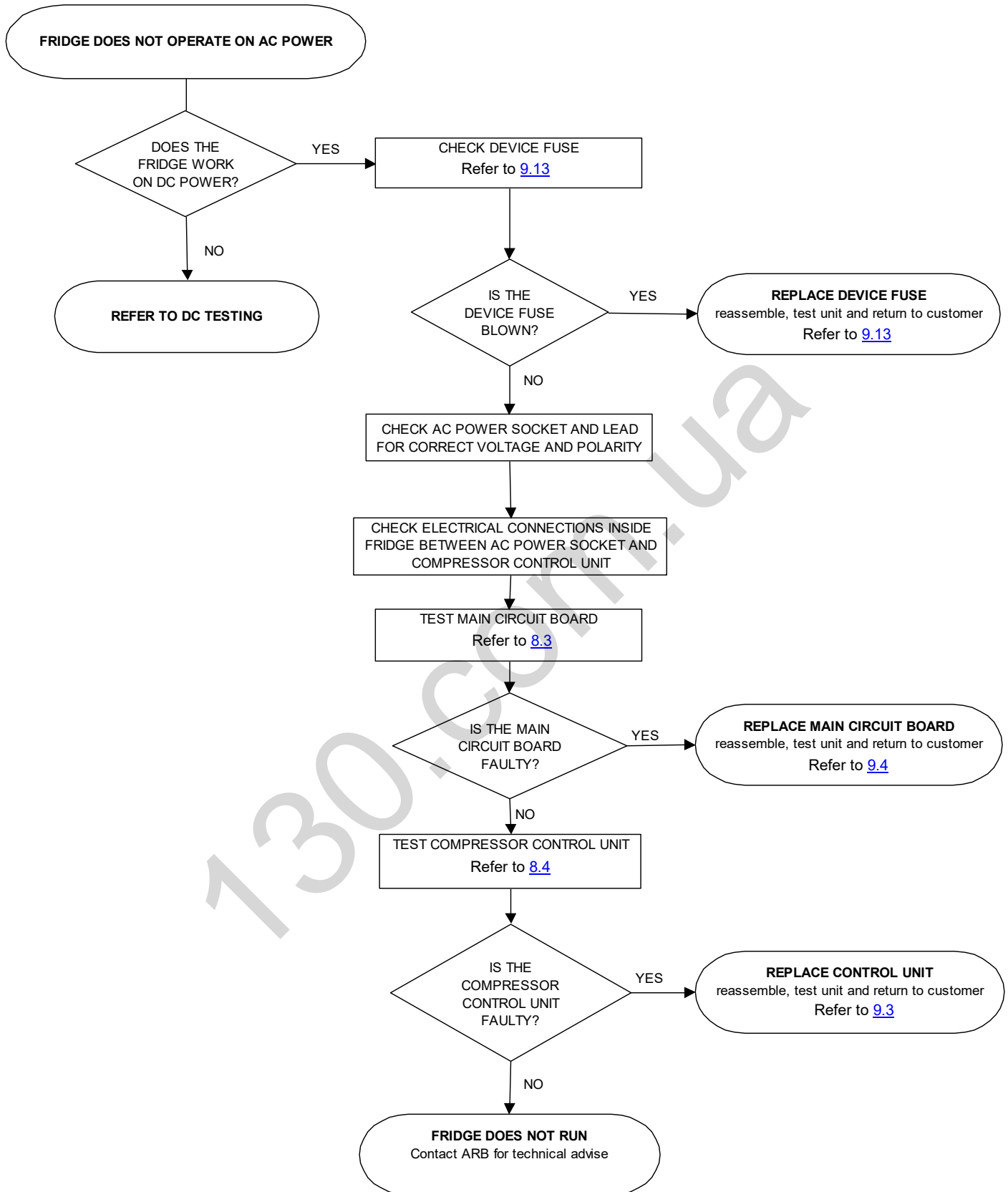

7.2 Fridge will not run on 12/24V DC power

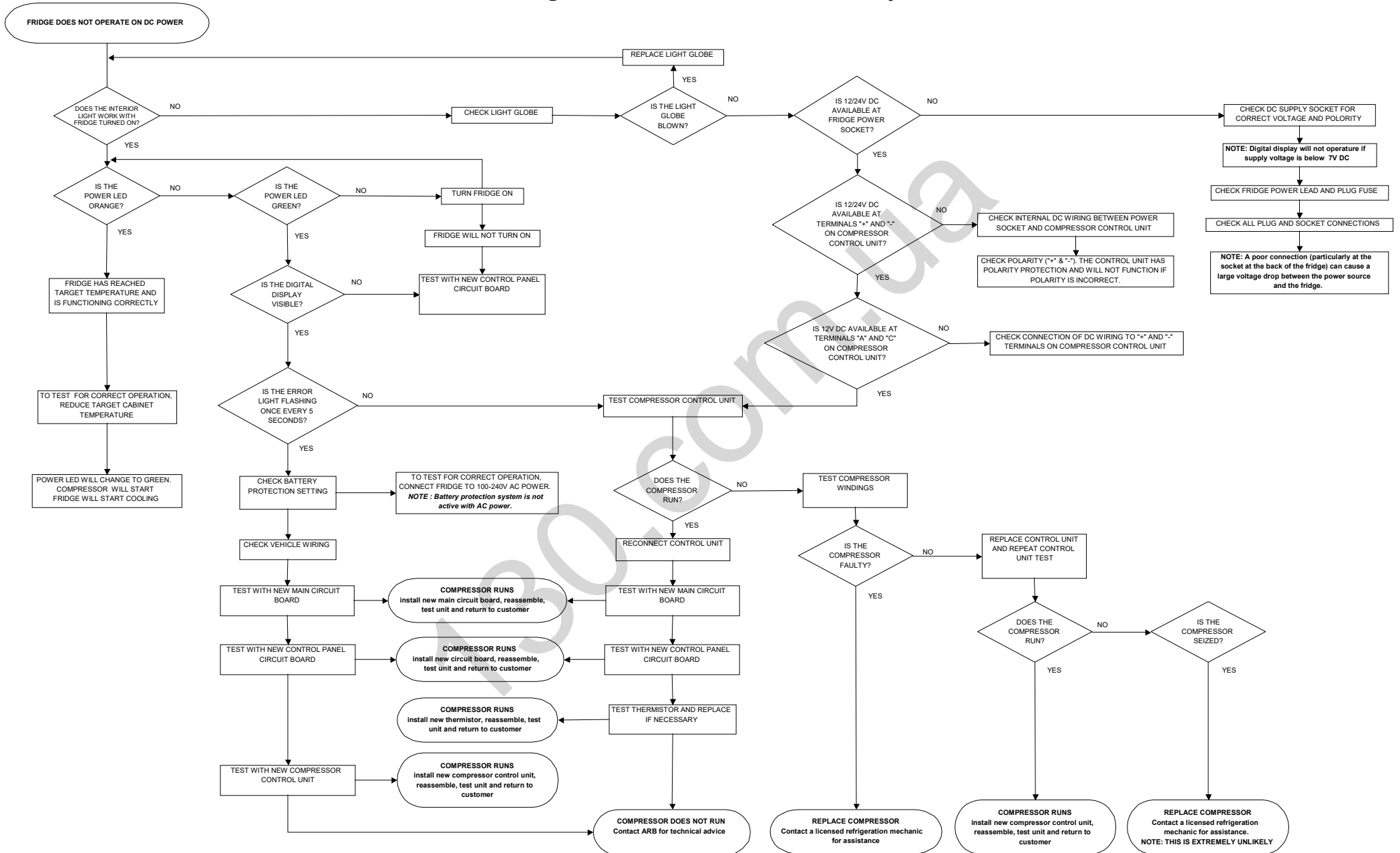

8 CHECKS AND TESTS

8.1 Vehicle wiring system

It is important that the wiring system is capable of carrying the required load to power the fridge freezer. The accessories wiring system in many vehicles is not adequate for such a task. This is particularly true in the rear cargo space of many modern four wheel drives. In some vehicles, these circuits are also connected to the ignition switch and will not supply power if the ignition is turned off.

Measuring the voltage across the battery will not give a true indication of the voltage being supplied to the fridge. Any voltage readings must be taken at the fridge supply socket with the fridge running. This is because any voltage drop caused by losses in the system must be accounted for. Without the fridge running, there will be no load on the circuit and it will not be possible to measure the voltage drop.

Voltage drop is the difference between the voltage readings taken at the fridge supply socket with and without the fridge running. It is calculated using the formula shown below.

$$\begin{array}{l} \text{Voltage drop between} \\ \text{battery and supply} \\ \text{socket} \end{array} = \begin{array}{l} \text{Voltage reading at} \\ \text{supply socket without} \\ \text{fridge running} \end{array} - \begin{array}{l} \text{Voltage reading at supply} \\ \text{socket with fridge running} \end{array}$$

NOTE: In some 12V vehicle wiring systems, the voltage drop between the battery and the rear factory accessories socket can exceed 2V DC.

It is important that the vehicle is not running while these voltage readings are taken. If the vehicle is running, the readings will be the supply voltage from the alternator and not the voltage from the battery.

To check the vehicle wiring system, ARB recommend using a voltage drop tester. The voltage drop tester will simulate the start-up conditions of the Danfoss Compressor. These voltage drop testers are available from ARB and have been specifically built to simulate the running of an ARB Fridge Freezer (all models).

The procedure for testing a vehicle wiring system using a voltage drop tester is given below. Suggested actions based on the results of the voltage drop test are given at the end of this procedure.

VOLTAGE DROP TEST

Purpose: To test the vehicle wiring system for voltage drop under a simulated fridge freezer load.

Procedure: See below



Turn off the vehicle's engine.

Turn off the vehicle's ignition.

Insert the plug from the voltage drop tester into the fridge/accessories supply socket.

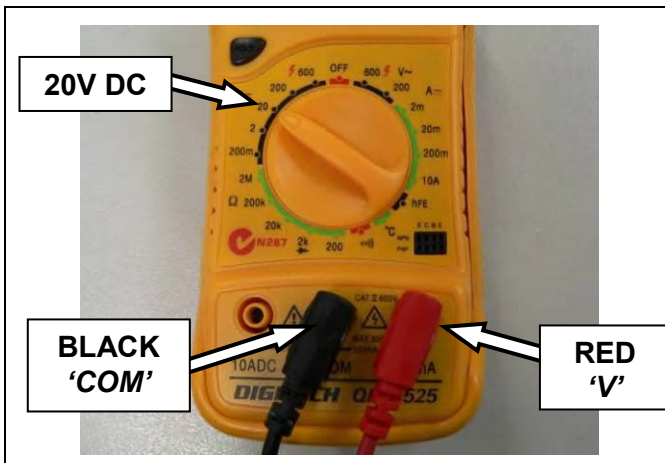

Connect the red lead from the voltage drop tester to the volt ('V') socket on the multimeter.

Connect the black lead from the voltage drop tester to the 'COM' socket on the multimeter.

Set the multimeter to 20V DC.



Record the voltage displayed on the multimeter as '**VOLTAGE A**'.

If no voltage is measured, check whether the circuit is connected to the ignition switch and whether the ignition is turned off.

NOTE: ARB recommend that a dedicated wiring circuit be used to connect the fridge directly to the battery via a suitable fuse. Refer to the wiring advice below.



Press the red button on the voltage drop tester and hold for no longer than 10 seconds.

This will simulate the start-up of the Danfoss compressor.

With the button pressed down, record the voltage displayed on the multimeter as '**VOLTAGE B**'.



Turn off the multimeter and disconnect the voltage drop tester from the power socket.

Record the voltage across the supply battery terminals as '**VOLTAGE C**'.

Calculate the voltage drop by using the formula below.

$$\text{VOLTAGE DROP} = \text{VOLTAGE 'A'} - \text{VOLTAGE 'B'}$$

If the voltage drop is greater than 0.5 V in a 12V DC system, significant voltage drop is present within the circuit while the fridge is running.

TEST OUTCOMES – VOLTAGE DROP TEST

1. Voltage drop detected

If a significant voltage drop (greater than 0.5 volts for a 12V DC system) is detected, the following checks should be undertaken.

A. Check the size of the wiring used in the circuit.

A dedicated wiring circuit should be installed to power the fridge freezer. This circuit should be as short as practical and should be connected directly to the power supply via a suitable fuse.

- Use a 15 Amp fuse for 12V DC applications and a 7 Amp fuse for 24V DC applications.
- For cable lengths up to 6m (20'), use a minimum automotive cable size of 6 mm (approx 4.5 mm²).
- For cable lengths greater than 6m (20'), consult a qualified auto electrician for advice on the correct wire size.
- For best performance, the negative wire of the circuit should be connected directly to the negative terminal of the battery. It should not be grounded directly to the vehicle body or chassis.

B. Check that all terminals and joints are clean and in good condition.

C. Check that the voltage at the supply socket (*VOLTAGE B*) is above the cut-out voltage for the selected battery protection setting (refer to section [6.6](#)).

D. Check that the supply socket is not attached to the vehicle ignition switch. If it is, make sure that the ignition switch is not turned off.

2. Measured voltage below cut-out voltage

If the voltage measured at the supply socket (*VOLTAGE B*) is below the cut-out voltage for the current battery protection setting (refer to section [6.6](#)), the compressor will not run and the error light will flash once every 5 seconds. In this case, the correct battery protection setting should be selected or the supply cable upgraded to 4.5mm² to minimise voltage drop

3. Low voltage detected at both battery and supply socket

If low voltage is detected at both the battery (*VOLTAGE C*) and the supply socket (*VOLTAGE B*), it is recommended that the battery be charged or replaced.

8.2 Test compressor control unit – 12/24V DC



Purpose: To verify the correct operation of the compressor control unit on 12/24V DC.

Approach: This test will isolate the compressor control unit from the external control circuit. The external control circuit includes the main circuit board, the control panel circuit board, the thermistor and the wiring loom.

Test pass: The compressor runs. In this case the main circuit board, the control panel circuit board, the thermistor or the wiring loom are likely to be faulty.

Test fail: The compressor does not run. In this case the compressor control unit is likely to be faulty. It is also possible that the compressor could be faulty but this is EXTREMELY unlikely.

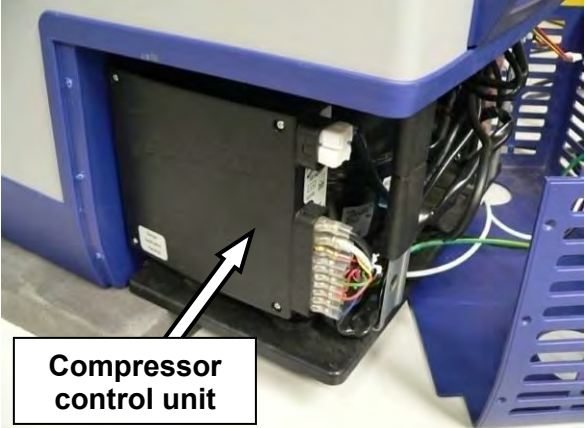
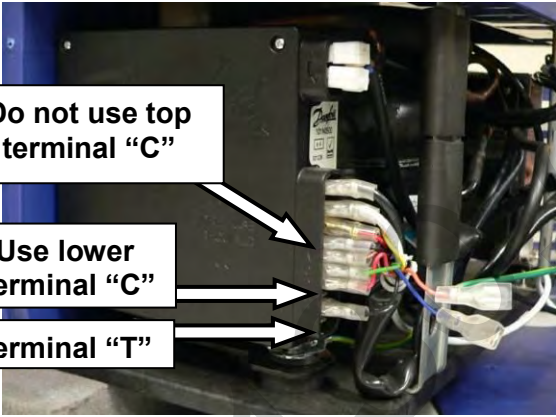
Procedure: See below

 <p>Compressor control unit</p>	<p>Disconnect all power leads from the back of the fridge.</p> <p>Remove the rear cover (refer to section 9.2).</p> <p>Identify the compressor control unit.</p>
 <p>Do not use top terminal "C"</p> <p>Use lower Terminal "C"</p> <p>Terminal "T"</p>	<p>Disconnect the push on connectors from terminal "T" and the lower terminal "C".</p> <p>NOTE: There are 2 terminals on the control unit that are labelled "C". Only disconnect the plug from the lower "C" terminal.</p>
 <p>"-"</p> <p>"+"</p> <p>Connection to 12/24V DC</p>	<p>Apply 12 or 24V DC to terminals "+" and "-" on the compressor control unit.</p> <p>Use a DC voltmeter to confirm that the polarity of the 12 or 24V DC supply voltage across terminals "+" and "-" is correct.</p> <p>NOTE: The compressor control unit has polarity protection and will not work if the polarity is incorrect.</p> <p>NOTE: The compressor control unit and digital display will not operate if the supply voltage is below approximately 7V DC.</p> <p>ARB recommends that the supply voltage be applied through the DC power socket in the back of the fridge and not directly to the control unit.</p>

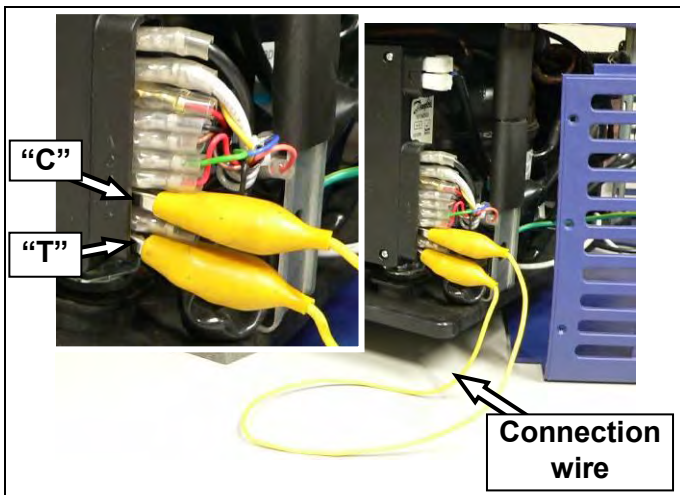

Connect between terminals “T” and the lower terminal “C” using a short length of wire as shown.

NOTE: *The connecting wire should be terminated with either push-on connectors or spring loaded clips suitable for connection to the terminals.*

CAUTION: *Make sure that there are no short circuits between the terminals and the connecting wire.*

TEST PASS – COMPRESSOR RUNS

With terminals “T” and lower “C” connected, the compressor should start running and the system should start cooling. In this case, the control unit is functioning correctly on 12/24V DC.

The compressor control unit has now been eliminated as a possible fault.

The next step is to investigate a fault in the main circuit board, the control panel circuit board, the thermistor or the wiring loom.

Before continuing, disconnect the fridge from the 12/24V DC power supply, remove the connecting wire and refit the push on connectors to terminals “T” and lower “C”.

NOTE: *During this test, the compressor should draw approximately 3 amps.*

NOTE: *There may be a delay of up to 5 seconds between connection of terminals “T” & lower “C” and the compressor starting.*

TEST FAIL – COMPRESSOR DOES NOT RUN

With terminals “T” and lower “C” connected, the compressor does not start. In this case, either the compressor or the compressor control unit are likely to be faulty.

Test the compressor windings (refer to section [8.5](#)).

If the compressor windings are OK, replace the control unit (refer to section [9.3](#)) and repeat the compressor control unit test.



If the compressor does not run with a new compressor control unit, the compressor may be seized. While it is possible for the compressor to be seized, it is EXTREMELY unlikely.

8.3 Test main circuit board – 100-240V AC

WARNING: This test should only be performed by a licensed electrician.

Purpose: To verify that the AC power section of the main circuit board is functioning correctly.

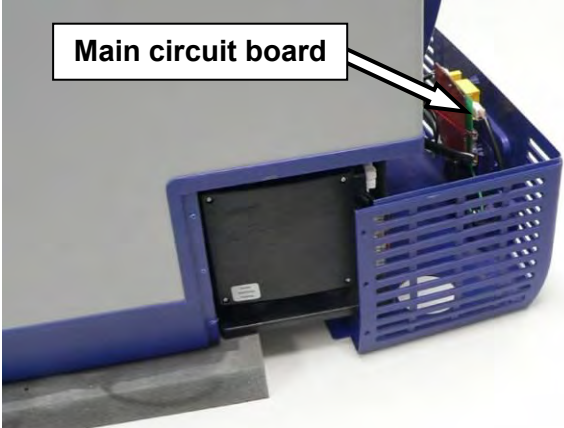
Procedure: See below.

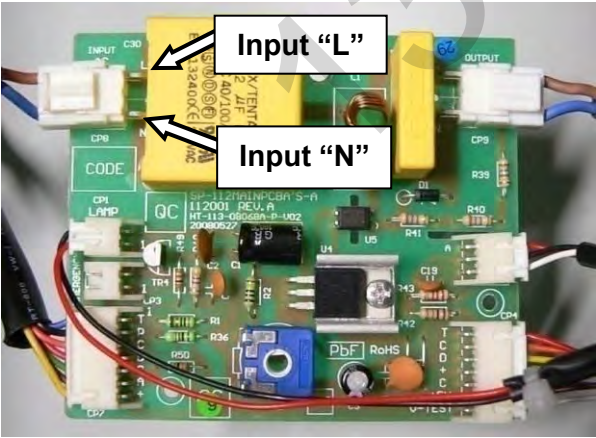
	<p>Disconnect all power leads from the back of the fridge.</p> <p>Remove the rear cover (refer to section 9.2).</p> <p>Identify the main circuit board.</p>
	<p>Apply 100-240V AC power to the fridge via the power socket in the back of the fridge.</p>
	<p>Using an AC voltmeter, check that 100-240V AC power is measured between the live “L” and neutral “N” terminals on the input side of the main circuit board as shown.</p> <p>If no AC power is detected, check the device fuse and the AC power supply.</p> <p>NOTE: The main circuit board has been removed from the fridge for clarity only. This test should be performed with the circuit board installed in the fridge.</p>

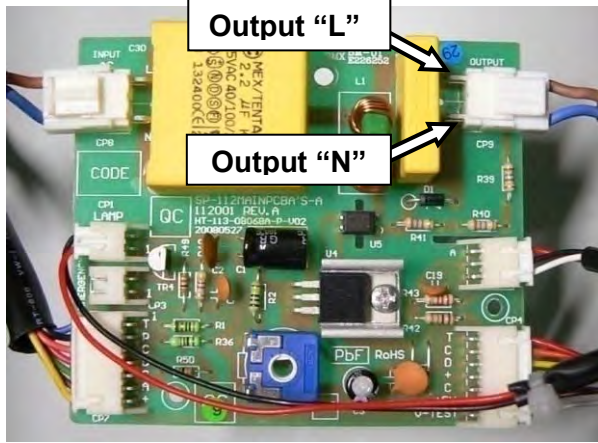

Using an AC voltmeter, check that the same AC voltage is measured between the live “L” and neutral “N” terminals on the output side of the main circuit board as shown.

NOTE: The main circuit board has been removed from the fridge for clarity only. This test should be performed with the circuit board installed in the fridge.

TEST PASS – AC POWER IS MEASURED ON BOTH SIDES OF THE MAIN CIRCUIT BOARD

The same AC power measurement is recorded across both the input and output pins of the main circuit board. In this case, the AC power section of the main circuit board is functioning correctly.

The main circuit board has now been eliminated as a possible fault.

TEST FAIL AC POWER IS ONLY MEASURED ON THE INPUT SIDE OF THE MAIN CIRCUIT BOARD

AC power is measured across the input pins of the main circuit board but not across the output pins. In this case, it is likely that the main circuit board is faulty.

The main circuit board should be replaced and the test repeated (refer to section [9.4](#)).

8.4 Test compressor control unit – 100-240V AC

WARNING: This test should only be performed by a licensed electrician.

Purpose: To verify the correct operation of the AC power section of the compressor control unit.

Procedure: See below.

 <p>Compressor control unit</p>	<p>Disconnect all power leads from the back of the fridge.</p> <p>Remove the rear cover (refer to section 9.2).</p> <p>Identify the compressor control unit.</p>
 <p>Connection to 100-240V AC</p>	<p>Apply 100-240V AC power to the fridge via the power socket in the back of the fridge.</p>
 <p>"L"</p> <p>"N"</p>	<p>Using an AC voltmeter, check that 100-240V AC power is measured between the live "L" and neutral "N" terminals on the compressor control unit.</p> <p>If no AC power is detected between terminals "L" and "N" check the device fuse, the AC power supply and the main circuit board (refer to section 8.3).</p> <p>NOTE: There may be small variation above or below 100-240V AC depending on the AC supply voltage.</p>

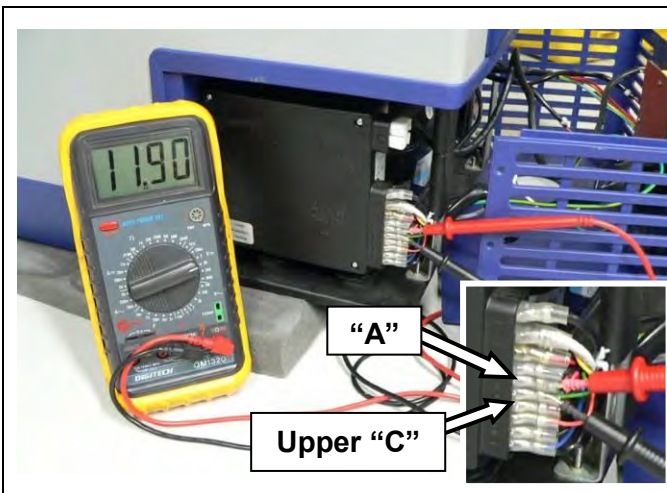

Using a DC voltmeter, check that approximately 12V DC is measured between terminals “A” and upper “C” on the compressor control unit.

NOTE: The voltage measurement may vary depending on the sensitivity of the DC volt meter.

TEST PASS – 12V DC IS MEASURED BETWEEN TERMINALS “A” AND UPPER “C”

With 100-240V AC power supplied to terminals “L” and “N”, approximately 12V DC should be measured between terminals “A” and upper “C”. In this case, the AC power section of the control unit is functioning correctly.

The compressor control unit has now been eliminated as a possible fault.

TEST FAIL – 12V DC IS NOT MEASURED BETWEEN TERMINALS “A” AND UPPER “C”

With 100-240V AC power supplied to terminals “L” and “N”, approximately 12V DC is not measured between terminals “A” and upper “C”. In this case, the AC power section of the control unit is faulty.

The compressor control unit has been identified as faulty and should be replaced (refer to section [9.3](#)).

Replace the control unit and repeat this test.

8.5 Test compressor

Purpose: To verify that the internal compressor windings are functioning correctly.

Procedure: See below.

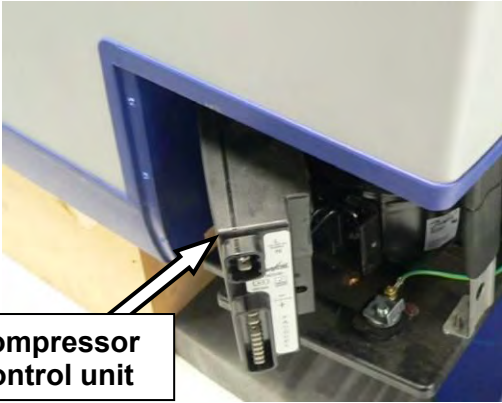
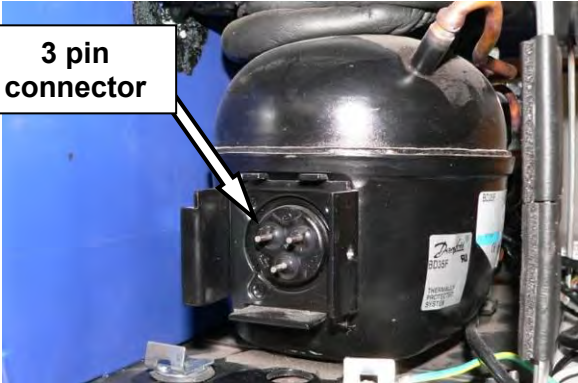
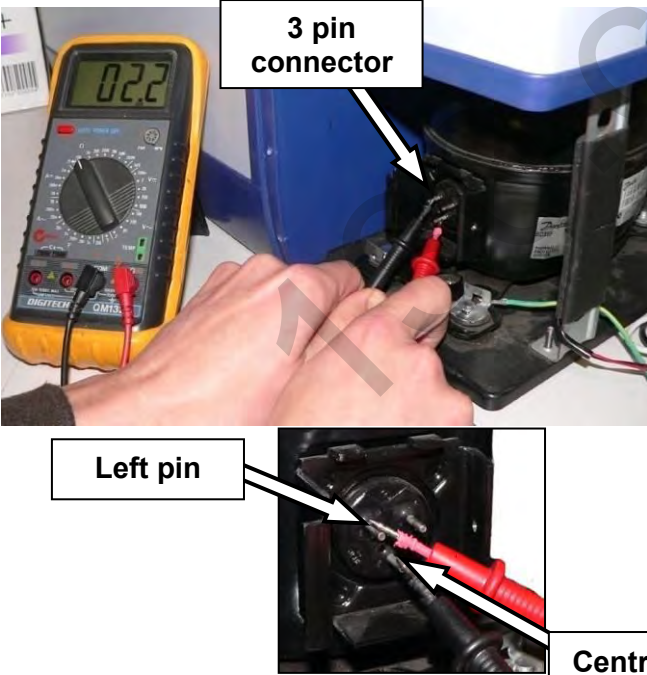
 <p>Compressor control unit</p>	<p>Disconnect all power leads from the back of the fridge.</p> <p>Remove the rear cover (refer to section 9.2).</p> <p>Remove the compressor control unit (refer to section 9.3).</p>
 <p>3 pin connector</p>	<p>Identify the 3-pin connector on the side of the compressor.</p>
 <p>3 pin connector</p> <p>Left pin</p> <p>Centre pin</p> <p>Right pin</p>	<p>Using an ohm meter (Ω), test the resistance of the two motor windings using the following process.</p> <ol style="list-style-type: none">1. Measure the resistance between the centre and left pins. The reading should be between approximately 2.0 and 2.5 ohms (Ω).2. Measure the resistance between the centre and right pin. The reading should be between approximately 2.0 and 2.5 ohms (Ω).

TEST PASS

If resistance across both windings is approximately 2.0-2.5 ohms (Ω), compressor windings are OK.

TEST FAIL

If either winding shows an open circuit, the compressor is faulty and should be replaced.

8.6 Test thermistor

Purpose: To verify that the thermistor is operating correctly.

Procedure: Refer to section [12](#) to identify if the fridge has a serviceable thermistor.

For fridges with serviceable thermistors

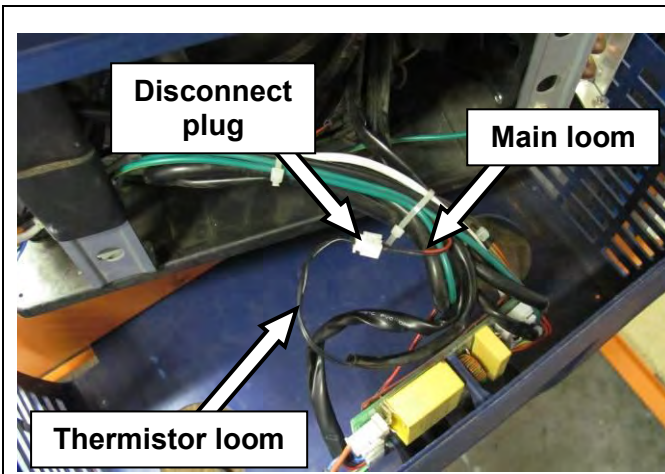

Disconnect all power leads from the back of the fridge.

Remove the rear cover (refer to section [9.2](#)).

Locate and disconnect the 2 pin male thermistor plug within the main wiring loom.

NOTE: On fridges manufactured after January 2014, the thermistor is connected directly to connector CN7 on the main PCB.

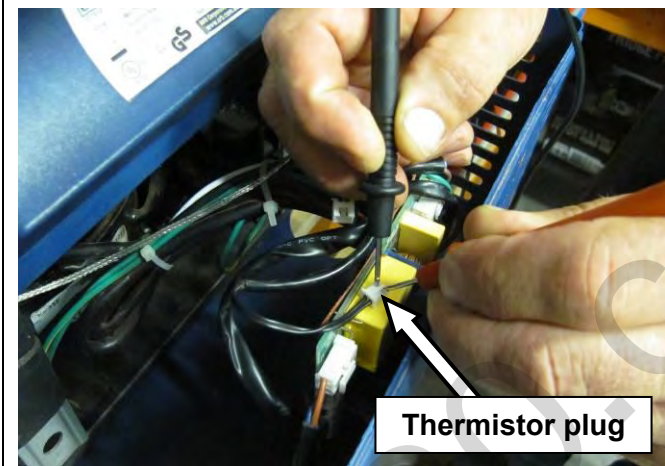

Using an ohm meter (Ω), measure the resistance value of the thermistor.

To do this, measure the resistance between the two metal contacts in the plastic connector plug as shown.

NOTE: The resistance of the thermistor will increase as the fridge gets colder.

Measure the temperature of the plastic liner at the base of the fridge.

For fridges without serviceable thermistors

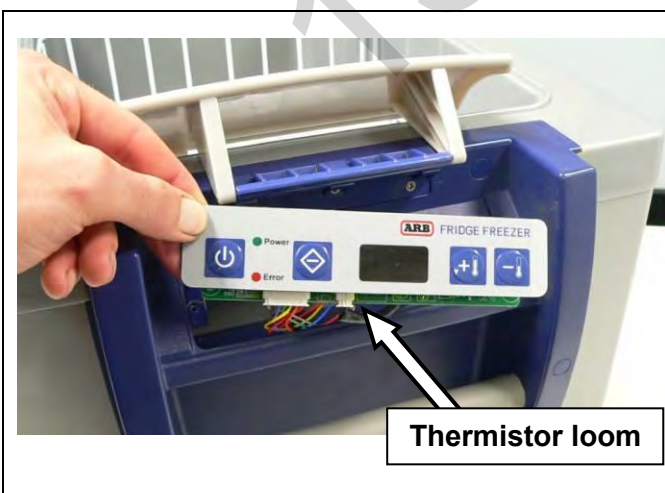

Disconnect all power leads from the back of the fridge.

Remove the control panel complete with circuit board (refer to section [9.1](#)).

Locate the thermistor plug on the control panel circuit board.

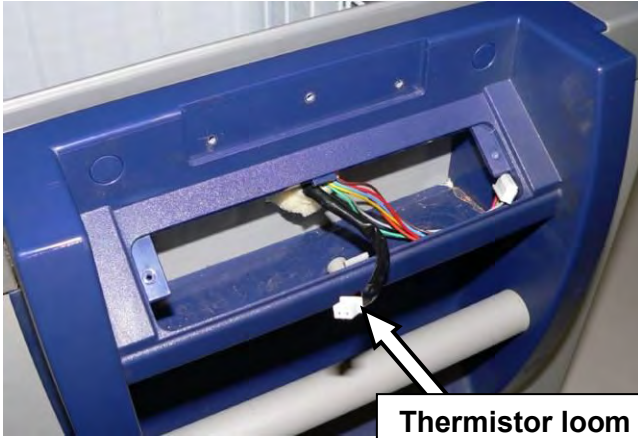

Thermistor loom

Disconnect the thermistor connector plug from the control panel circuit board.

NOTE: The control panel assembly has been removed for clarity only. There is no need to remove the control panel assembly to conduct this test.



Using an ohm meter (Ω), measure the resistance value of the thermistor.

To do this, measure the resistance between the two metal contacts in the plastic connector plug as shown.

NOTE: The resistance of the thermistor will increase as the fridge gets colder.

Measure the temperature of the plastic liner at the base of the fridge.

For all fridges

Thermistor resistance values

Temperature of plastic liner at base of fridge	Resistance Value
10°C (50°F)	18k Ω
5°C (41°F)	22k Ω
0°C (32°F)	28k Ω
-5°C (23°F)	35k Ω
-10°C (14°F)	44k Ω

NOTE: At approximately 20°C (68°F) degrees, the thermistor should read between 8-14k Ω .

Check the measured resistance against the resistance values in the table for the given temperature.

NOTE: Allow a variation of $\pm 5k \Omega$ between the measured resistance and the values in the table.

TEST PASS

If the measured resistance is within $\pm 5k \Omega$ of the tabulated value, the thermistor is functioning correctly.

TEST FAIL

If the measured resistance varies greatly from the tabulated value or an open circuit is detected, the thermistor is faulty and should to be replaced (refer to section [9.22](#)).

8.7 Adjust internal temperature correlation





Purpose: To adjust the internal temperature calibration so that the display temperature matches the temperature at the base of the fridge.



This adjustment should only be necessary if the thermistor has been replaced.

NOTE : *A display temperature within 2-3°C (3.6-5.4°F) of the actual temperature at the base of the fridge is within normal on/off cycle temperature variation. If this is the case, the internal temperature calibration should not be changed.*

Procedure:

- Connect the fridge to 12/24V DC or 100-240V AC.
- Turn the fridge on.

- Press and hold  and  simultaneously until  or  appears on the display. The symbols displayed will depend on whether °C or °F is selected.

- Push  or  to adjust the setting by one 1°C or 2°F.

- Continue pressing  or  until the desired adjustment is made.

NOTE: *The internal temperature calibration adjustment is limited to up or down 4°C or 8°F.*

- After 5 to 6 seconds of inactivity, the display will flash twice and return to displaying the current target temperature.
- Allow the fridge to cycle on and off a few times to allow for any temperature lag.
- Check the temperature display against the temperature at the base of the cabinet.

CALIBRATION SUCCESSFUL

If the temperature display is within 2-3 °C (3.6-5.4°F) of the temperature at the base of the fridge, return the unit to the customer and advise that this is within normal on/off cycle temperature variation.

REPEAT CALIBRATION



If the temperature display is not within 2-3 °C (3.6-5.4°F) of the temperature at the base of the fridge, repeat the calibration procedure above.

9 SERVICE

9.1 Control panel circuit board – Replace

The touch pad decal is an integral sealing component used to reduce water ingress around the electronic control panel. The touch pad is a single use item only. ARB recommends removing and replacing a damaged touch pad to maintain sealing integrity.

NOTE: If the fridge control panel has the clear protective decal accessory fitted, this must be removed prior to the following repair sequence.

	<p>Peel back control panel touch pad to expose mounting screws.</p> <p>Peel touch pad back just enough to clear the screws (about 10 mm).</p> <p>HINT: Use a sharp knife or blade to help peel back the touch pad.</p> <p>NOTE: If the touch pad is damaged, replace it only after the control panel has been re-installed.</p>
	<p>Remove 2 Phillips head screws.</p> <p>These screws attach the control panel assembly to the body of the fridge.</p>
	<p>Remove the complete control panel assembly.</p>

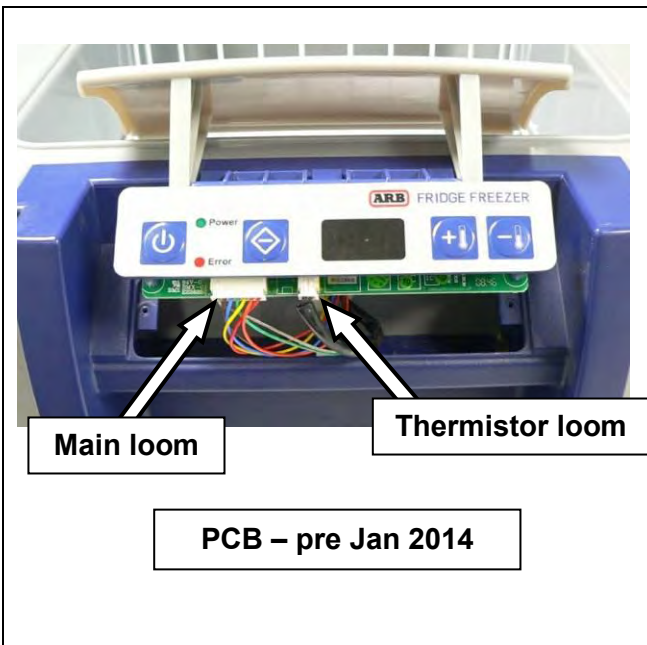

Disconnect the main wiring loom from the control panel circuit board.

Disconnect the thermistor loom from the control panel circuit board.

NOTE: For fridges manufactured after January 2014, the thermistor loom connects directly to the main PCB and not the display PCB as described above.

PCB - Jan 2014 on

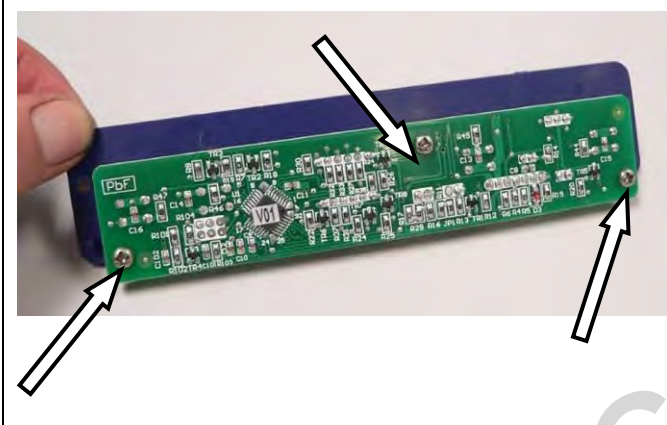
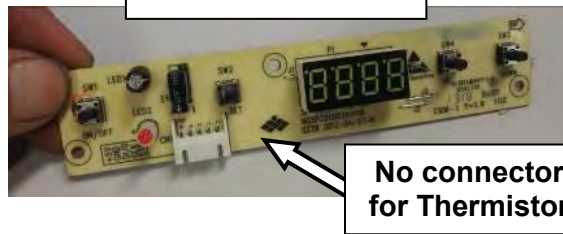

Remove 3 screws that join the touch pad to the control panel circuit board.

Connect thermistor and main wiring looms to the new control panel circuit board.

Restore power to the fridge and test for correct operation.

NOTE: The power and temperature settings are stored within the control panel circuit board. If changing the circuit board to diagnose a possible fault, make sure that the settings on the new circuit board are correct.



Fit new control panel circuit board to touch pad using the same 3 screws. Do not over tighten the screws.

Install the control panel assembly into the body of the fridge and fasten using the same 2 screws.

Apply new control panel touch pad.

9.2 Rear Cover – Remove and Refit

To remove rear cover

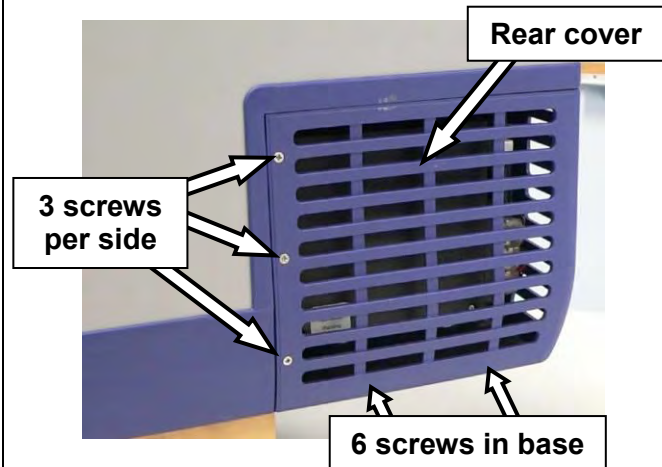

Disconnect all power leads from the back of the fridge.

Remove the 12 screws that connect the rear cover to the body of the fridge.



Pull the rear cover away from the body of the fridge.

CAUTION: Take care not to damage electrical wires or terminals.

To refit rear cover



Position rear cover against the body of the fridge so that the holes line up as shown.

Fasten the rear cover to the body of the fridge using the original 12 screws.

CAUTION: When refitting cover, ensure that all cables are securely fastened away from sharp, moving or hot surfaces.

9.3 Compressor control unit - Replace

For all fridge models

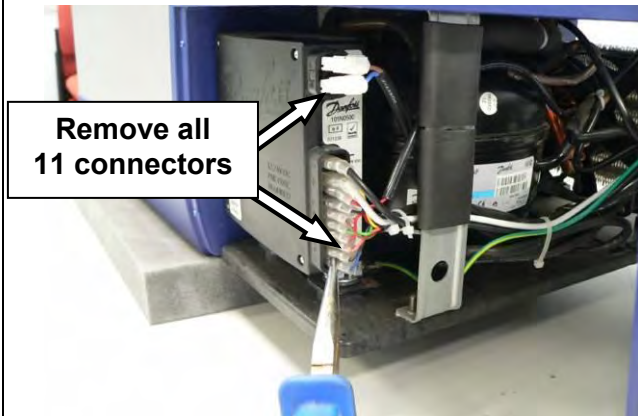

Disconnect all power leads from the back of the fridge.

Remove the rear cover (refer to section [9.2](#)).

Disconnect all 11 push on connectors from compressor control unit.

HINT: Use a pair of pliers to help release the connectors from the compressor unit terminals.



Remove 1 screw that connects the control unit to the compressor.

For 35L and 47L models only

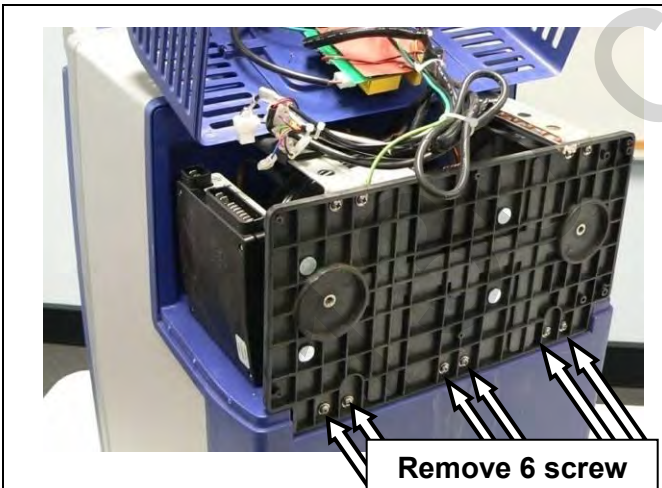

Remove 6 screws as shown to release the compressor mounting base from the underside of the fridge.

IMPORTANT: Support the compressor mounting base so that it does not drop more than 10 mm below the base of the fridge.

CAUTION: Take care not to stretch the refrigeration lines or power cables.

NOTE: The fridge has been rotated for photo only. ARB does not recommend placing the fridge on its end as shown.

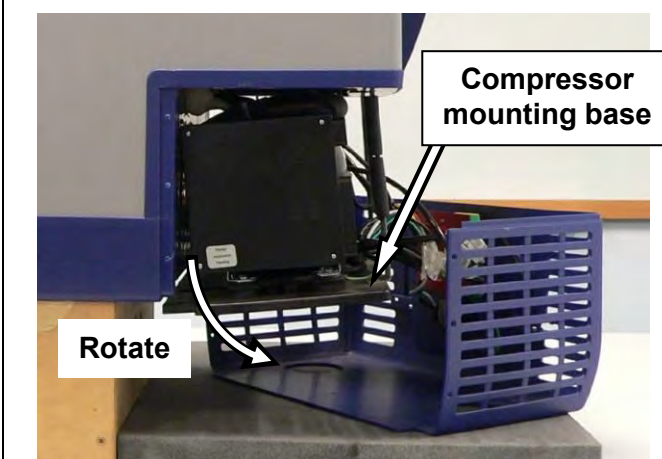

Allow the compressor mounting base to drop away from the body of fridge as shown.

NOTE: This step is required to provide room to unhook the compressor unit from the compressor housing.

For all fridge models

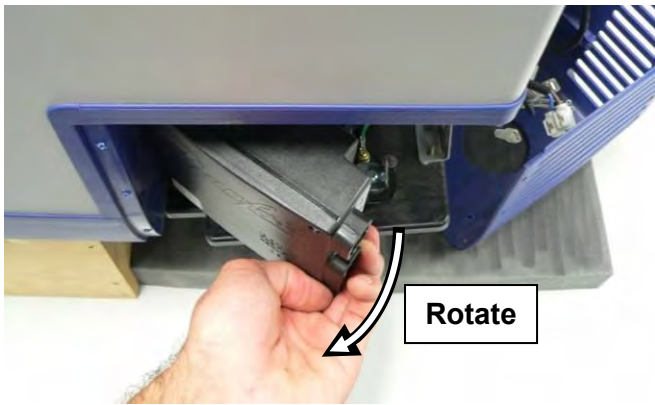

Remove the compressor control unit by rotating it away from the body of the fridge as shown.

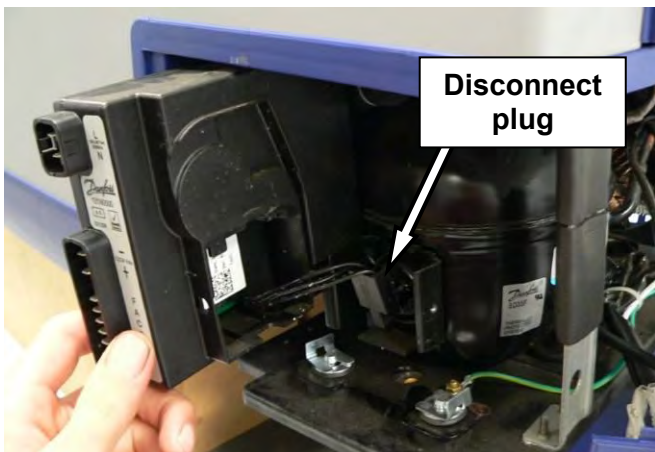

Disconnect the 3 wire plug that connects the compressor control unit to the compressor.

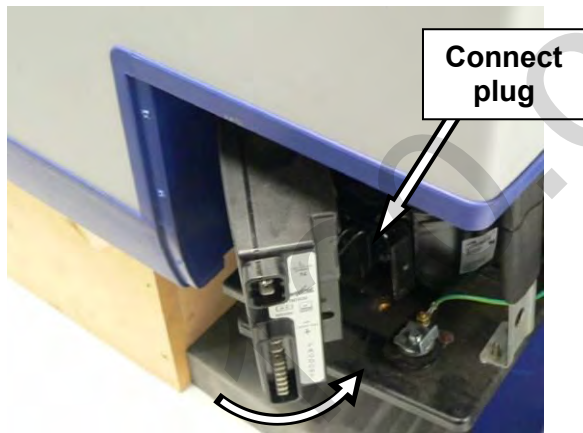

Connect the 3 wire plug from the new control unit to the compressor.

Fit new control unit to the compressor and attach using 1 Phillips head screw.

HINT: When fitting control unit, locate back edge of unit on bracket and then rotate towards body of fridge as shown.

'L' – BROWN	(AC Socket)
'N' – BLUE	(AC Socket)
'-' – BLACK	(DC Socket)
'+' – WHITE	(DC socket)
- YELLOW	(lower PCB)
- RED	(Fan)
'F' – BLACK	(Fan)
'A' – BROWN	(lower PCB)
'C' – GREEN	(lower PCB)
'D' – RED	(lower PCB)
'C' – ORANGE	(lower PCB)
'P' – BLACK	(lower PCB)
'T' – BLUE	(lower PCB)

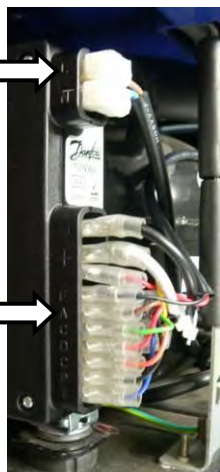

Connect the 11 connectors to the new control unit in the correct order (refer to diagram for wiring details).

Reposition compressor mounting base and fasten using the original 6 screws (35L and 47L only).

Refit the rear cover.

Restore power to fridge and check for correct operation.

CAUTION: Ensure that all cables are securely fastened away from sharp, moving or hot surfaces.

9.4 Main circuit board - Replace

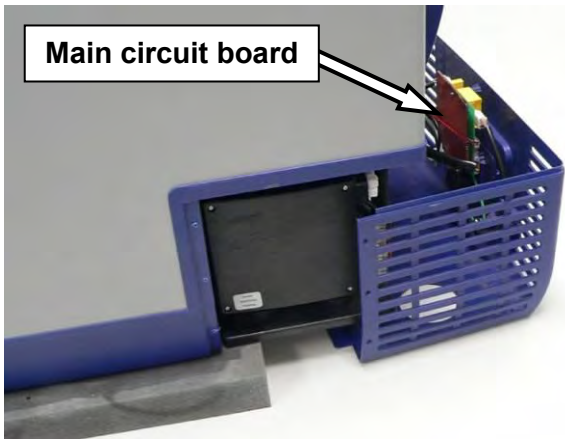

Disconnect all power leads from the back of the fridge.

Remove the rear cover (refer to section [9.2](#)).

Locate the main circuit board and disconnect all 6 connectors.

NOTE: The main circuit board and corresponding connectors were changed in January 2014. Refer to the following steps for correct wiring for each PCB.

Mark the location of each connector before disconnecting.

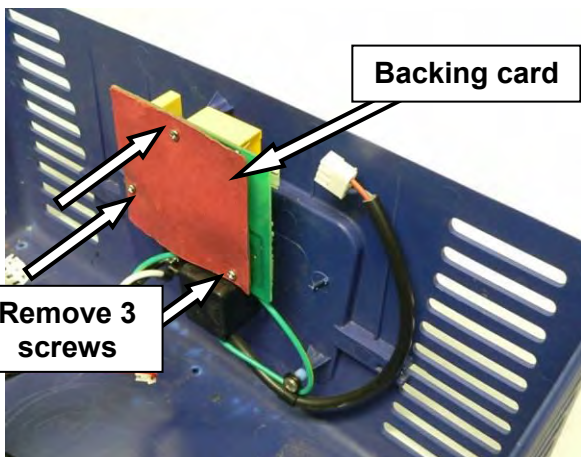

Remove the 3 screws that connect the main circuit board to the rear cover.

Remove the main circuit board.

Replace the main circuit board and reconnect using the original 3 screws. Do not over tighten the screws.

NOTE: Ensure that the backing card is refitted.

Reconnect the 6 electrical connectors.

Refit the rear cover.

Restore power to the fridge and test to confirm correct operation.

CAUTION: Ensure that all cables are securely fastened away from sharp, moving or hot surfaces.

MAIN PCB – pre January 2014

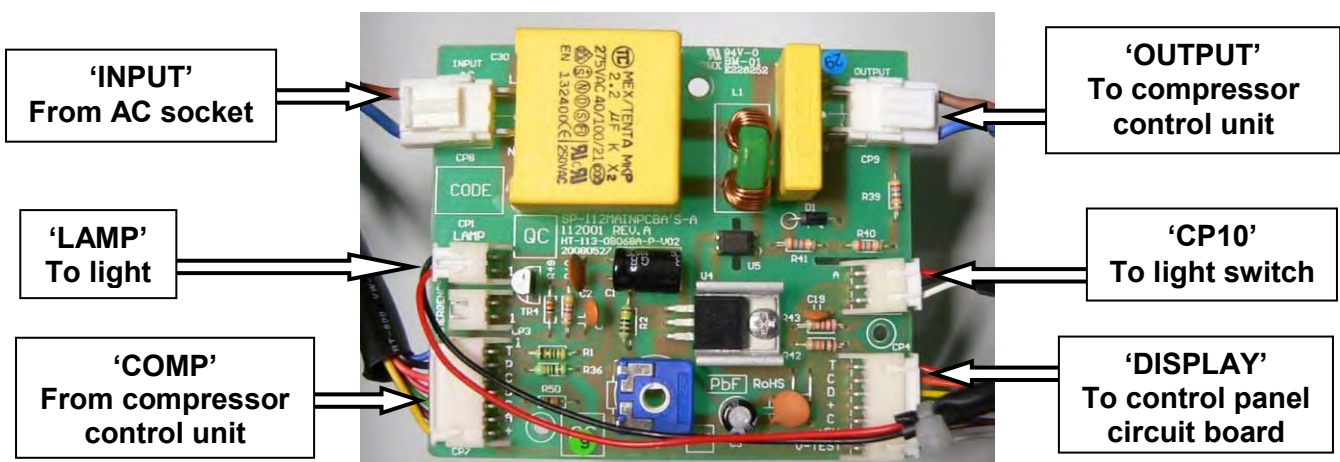

MAIN PCB – January 2014 on

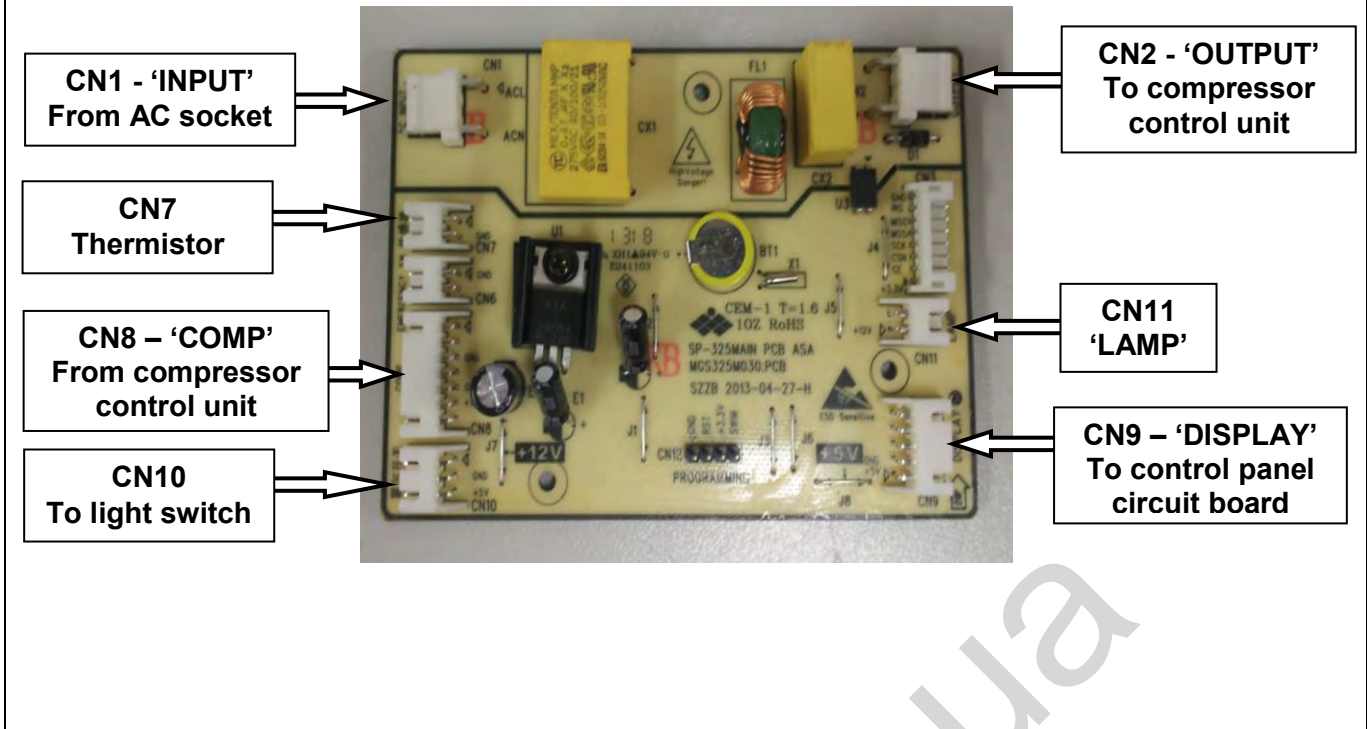

9.5 Rear Cover – Replace

Replace rear cover – to remove.



Disconnect all power leads from the back of the fridge.

Remove the rear cover (refer to section [9.2](#)).

CAUTION: Take care not to damage electrical wires or terminals.

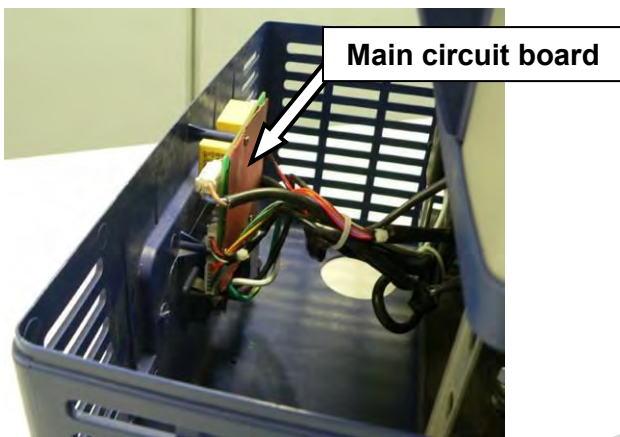

Disconnect the main circuit board from rear cover (refer to section [9.4](#)).

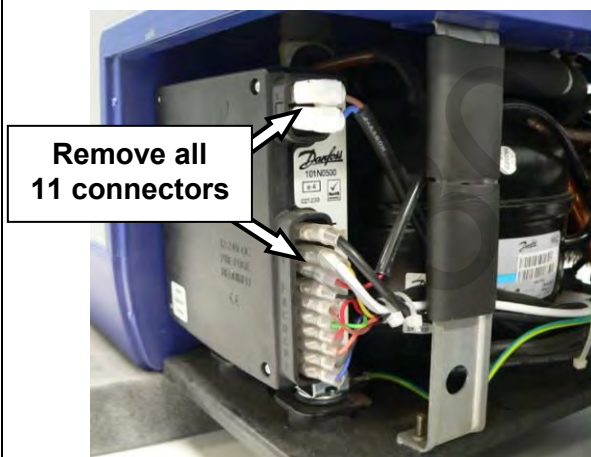

Disconnect all 11 push on connectors from compressor control unit.

HINT: Use a pair of pliers to help release the connectors from the compressor control unit terminals.

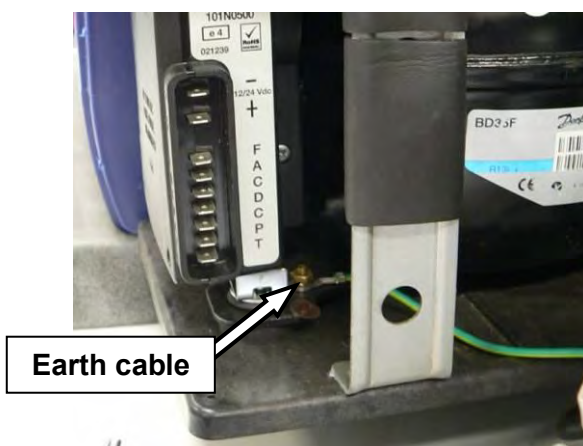

Disconnect the earth cable from the compressor mounting chassis.

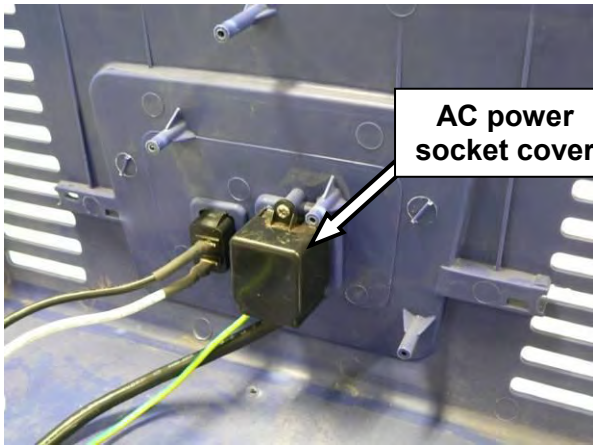

Remove the AC power socket cover.



Remove the decal label for the power panel.

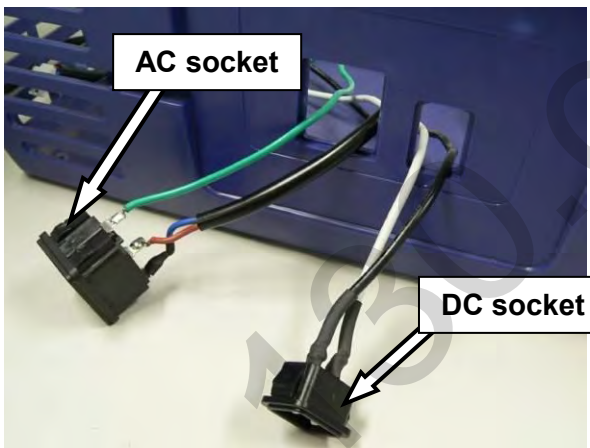

Remove the 12/24V DC socket. Withdraw the socket (complete with leads) through the hole in the rear cover as shown.

Remove 100-240V AC socket. Withdraw the socket (complete with leads) through the hole in the rear cover as shown.

HINT: Use a flat blade screw driver to depress the tabs on the back of the socket.

Discard old rear cover.

Replace rear cover – to refit

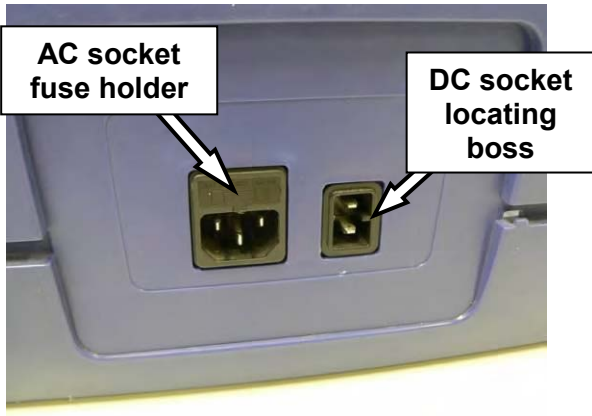

Fit the 12/24V DC and 100-240V AC sockets (complete with leads) to the new rear cover.

NOTE: Make sure that the fuse holder in the AC socket is at the top as shown.

NOTE: Make sure that the locating boss in the DC socket faces the outer edge of the fridge as shown.

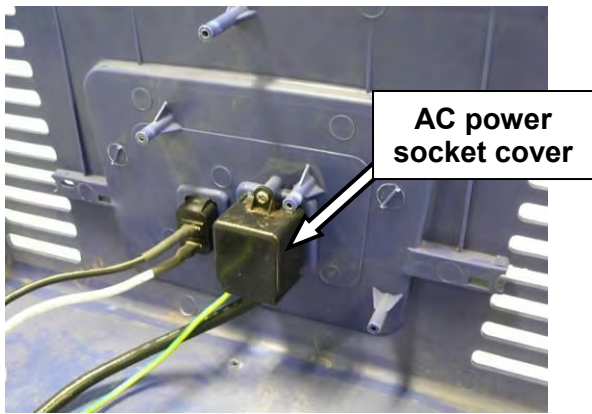

Refit the AC power socket cover.

Refit the earth cable to the compressor mounting chassis.

'L' – BROWN	(AC Socket)
'N' – BLUE	(AC Socket)

'-' – BLACK	(DC Socket)
'+' – WHITE	(DC socket)
- YELLOW	(lower PCB)
- RED	(Fan)
'F' – BLACK	(Fan)
'A' – BROWN	(lower PCB)
'C' – GREEN	(lower PCB)
'D' – RED	(lower PCB)
'C' – ORANGE	(lower PCB)
'P' – BLACK	(lower PCB)
'T' – BLUE	(lower PCB)

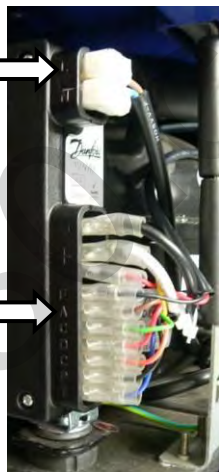

Reconnect the 11 connectors to the compressor control unit in the correct order (refer to wiring details).

Fit the main circuit board to the new rear cover. (refer to section [9.4](#))



Refit the rear cover.

CAUTION: Ensure that all cables are securely fastened away from sharp, moving or hot surfaces.

Fit new decal to the power panel.

9.6 Cooling fan - Replace

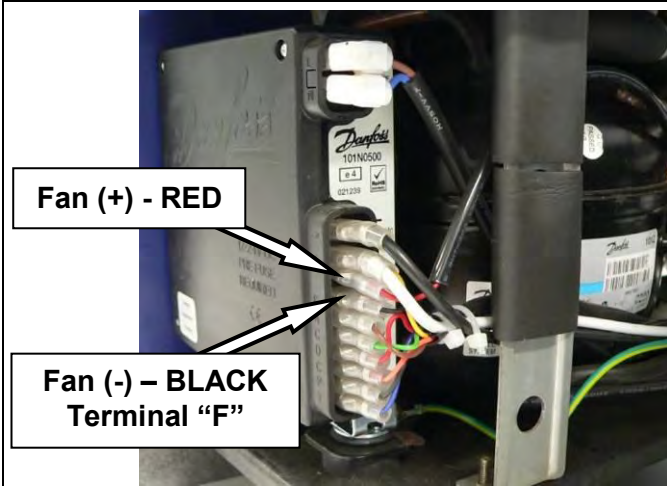

Disconnect all power leads from the back of the fridge.

Remove the rear cover (refer to section [9.2](#)).

Disconnect positive (+) and negative (-) fan wires from the compressor control unit as shown. The black fan wire is connected to terminal "F".

Connect the new fan to the control unit and confirm correct operation.

HINT: Do not install the new fan until the correct operation has been confirmed.

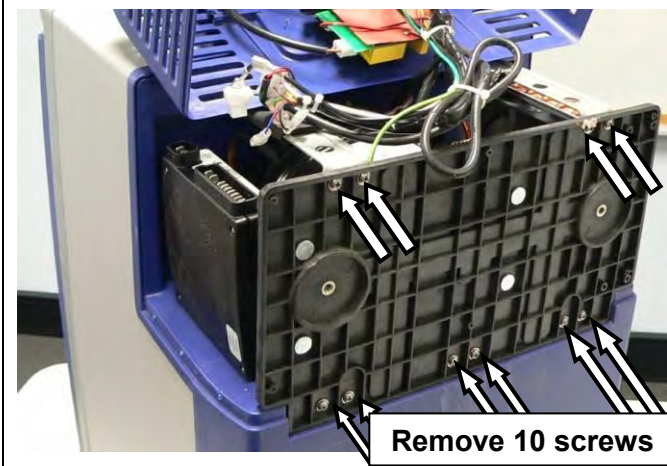

Remove the 10 screws that attach the compressor mounting base to the body of the fridge.

NOTE: The fridge has been rotated for photo only. ARB does not recommend placing the fridge on its end as shown.



Lower the compressor mounting base just enough to allow access to the fan mounting screws.

Support the compressor mounting base so that it does not drop more than 100 mm below the base of the fridge.

CAUTION: Take care not to stretch the refrigeration lines or power cables.

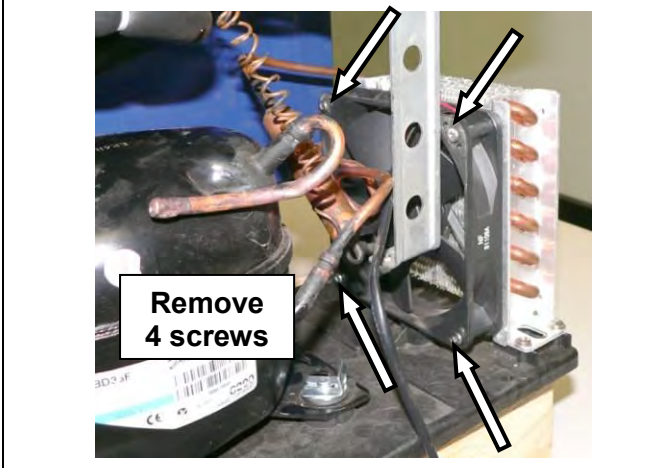

Remove the 4 screws that fasten the fan to the condenser.

Remove fan.

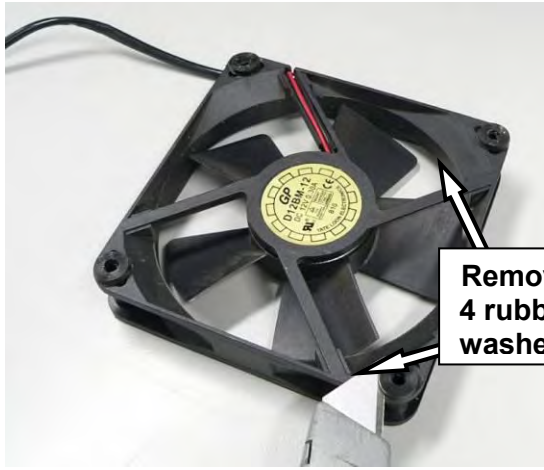

Remove and retain the 4 rubber washers from the fan.

HINT: A knife may be required to remove the rubber washers from the fan housing.

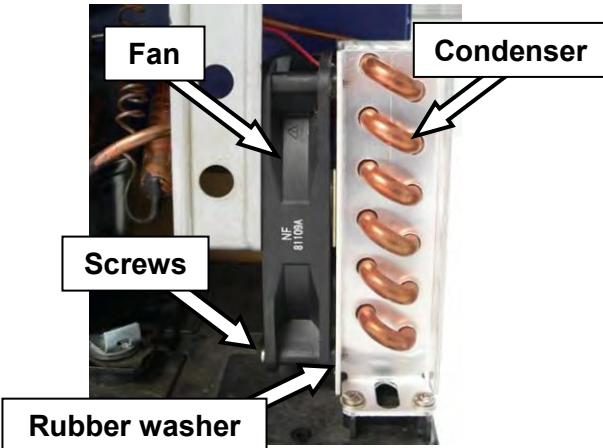

Fit the rubber washers between the new fan and the condenser as shown.

Install the new fan and fasten to the condenser using the original 4 screws.

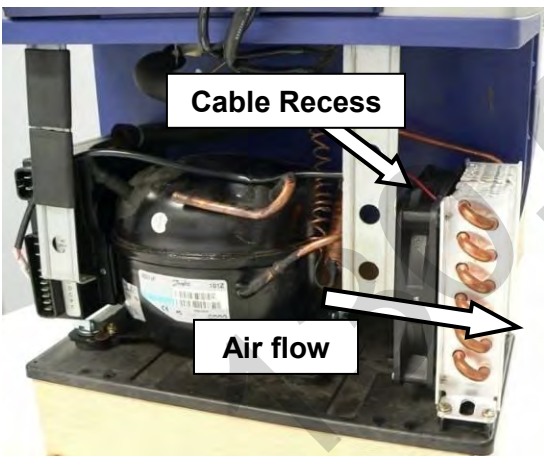

Position the fan with the cable recess at the top as shown.

Make sure that the airflow direction marked on the fan is pointing towards the condenser.



Refit the compressor mounting base and fasten using the original 10 screws.

Refit the rear cover.

CAUTION: Ensure that all cables are securely fastened away from sharp, moving or hot surfaces.

CAUTION: Make sure that all refrigeration lines are not under pressure and do not contact other parts of the fridge.

9.7 Latch assembly- Replace

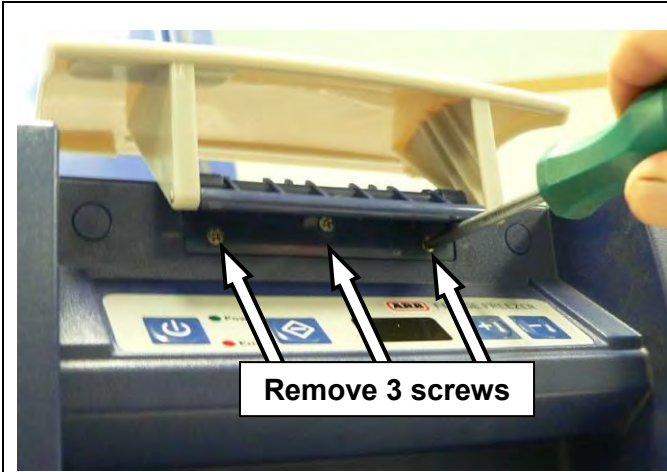

Open the lid.

Remove 3 screws as shown.

HINT: On early latches, the centre screw can be accessed through the hole in the pivot as shown.



Remove the latch assembly.



Position the new latch assembly into the recess as shown.

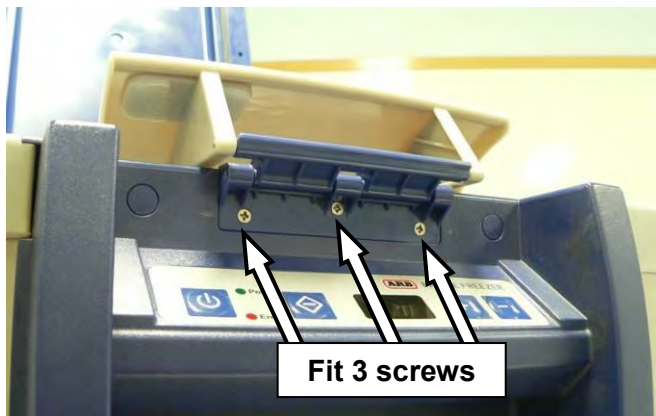

Fasten the new latch assembly using the same 3 screws removed in the previous step.

9.8 Front handle assembly - Remove and Refit



Disconnect all power leads from the back of the fridge.

Remove latch assembly (refer to section [9.7](#)).

Remove control panel (refer to section [9.1](#)).



Remove and discard all 6 screw cover plugs using the following steps.

NOTE: Removing the plugs by any other means may result in damage to the handle assembly.

Drill a small pilot hole in the centre of each plug.

CAUTION: Do not exceed a maximum drilling depth of 5 mm.

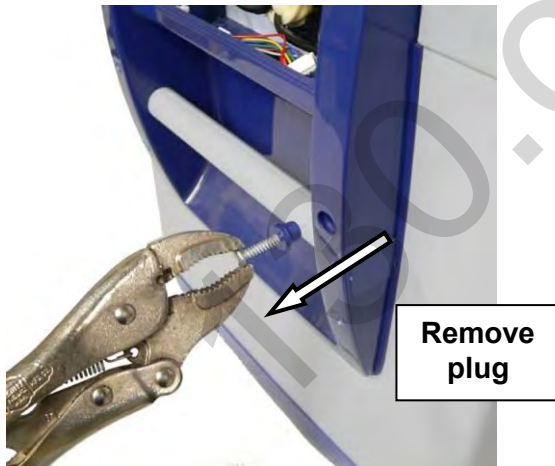

Thread a self tapping screw into the centre of each plug.

Remove each plug by pulling the screw (complete with plug) out of the handle assembly as shown.

HINT: Use vice grips or pliers to grip the head of the screw.

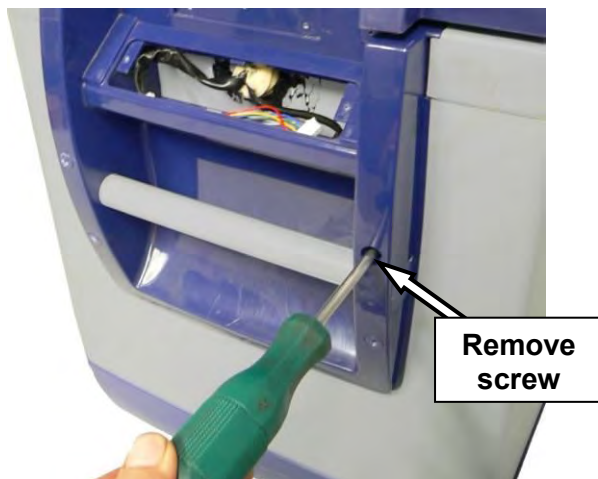

Remove and retain the 6 screws that fasten the handle assembly to the body of the fridge.



Remove the front handle assembly from the body of the fridge.



Front handle assembly

20 mm long screws

Wiring looms



Fit the new handle assembly to the body of the fridge using the original 6 screws.

The 2 screws that fasten the top of the assembly are only 20 mm long.

Make sure that the wiring looms pass through the handle assembly as shown.

NOTE: Do not over-tighten these screws.

J/K

J/K

I

L

G

H

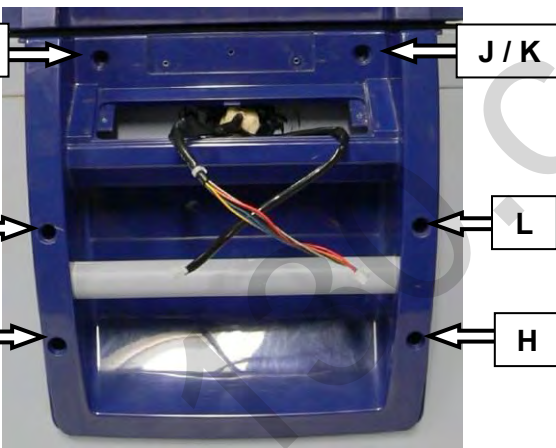

Fit new screw cover plugs into the front handle assembly.

Each hole has a unique plug and each plug is labelled with the correct letter.

When installing plugs, ensure that the correct plugs are fitted to the correct holes.

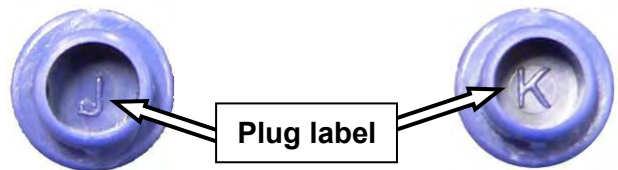



Plug label



Refit the control panel assembly (refer to section [9.1](#)).

Refit latch assembly (refer to section [9.7](#)).

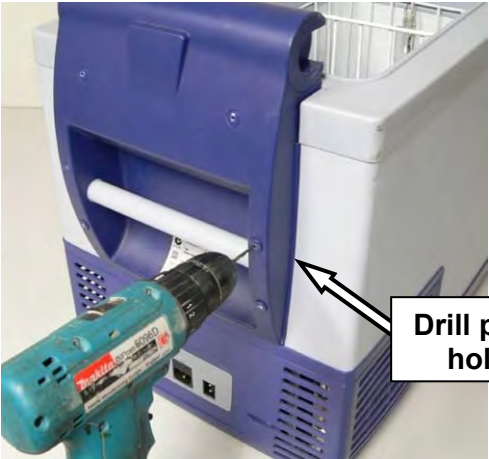
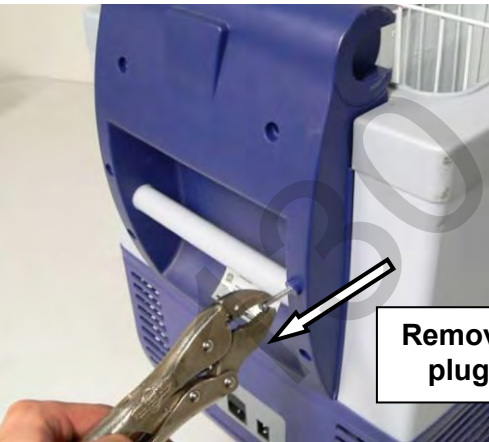
9.9 Rear handle assembly – Remove and Refit

 <p>Remove hinge sockets</p>	<p>Remove the lid.</p> <p>Remove and retain both hinge sockets and screws (refer to section 9.21),</p>
 <p>Drill pilot hole</p>	<p>Remove and discard all 6 screw cover plugs using the following steps.</p> <p>NOTE: Removing the plugs by any other means may result in damage to the handle assembly.</p> <p>Drill a small pilot hole in the centre of each plug.</p> <p>CAUTION: Do not exceed a maximum drilling depth of 5 mm.</p>
 <p>Remove plug</p>	<p>Thread a self tapping screw into the centre of each plug.</p> <p>Remove each plug by pulling the screw (complete with plug) out of the handle assembly.</p> <p>HINT: Use vice grips or pliers to grip the head of the screw.</p>
	<p>Remove and retain the 6 screws that fasten the handle assembly to the body of the fridge.</p>



Remove the rear handle assembly from the body of the fridge.

Rear handle assembly



Fit the new handle assembly to the body of the fridge using the original 6 screws.

NOTE: Do not over tighten these screws

NOTE: All 6 screws that fasten the assembly are 40 mm long.

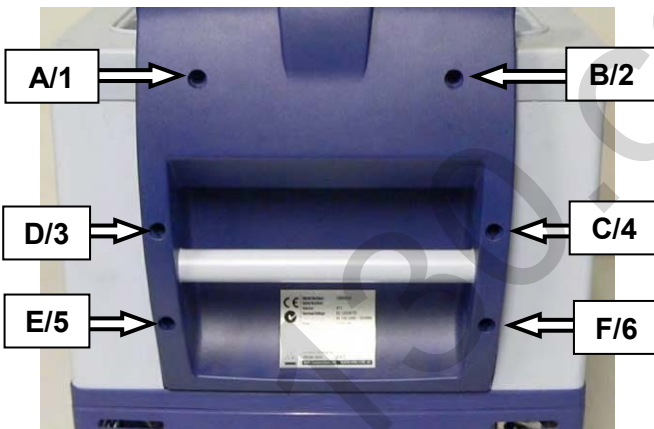

Fit new screw cover plugs into the rear handle assembly.

Each hole has a unique plug as shown. Plugs for 47L & 78L models are identified by a single letter. Plugs for 35L and 60L models are identified by a number.

When installing plugs, ensure that the correct plugs are fitted to the correct holes.

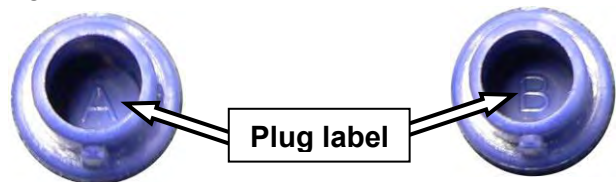

Compliance sticker

Fit hinge sockets to the new handle assembly using the original screws.

Remove the compliance sticker from the old handle assembly and apply to the new handle assembly.

Refit lid.

9.10 Light globe - Replace



Disconnect all power leads from the back of the fridge.

Position the basket to provide access to the light housing. This may require removing the basket.

Remove the transparent light housing from internal case of the fridge.

HINT: Place your finger under the lip of the light housing and ease it away from the internal case of the fridge.



Replace the defective globe.

Ensure the LEDs inside the bulb are facing the transparent face of the light housing.



Test that light functions correctly.

Refit light housing into cabinet of fridge.

9.11 Light housing - Replace



Disconnect all power leads from the back of the fridge.

Position basket to provide access to the light housing. This may require removing the basket.

Remove the transparent light housing from internal case of the fridge.

HINT: Place your finger under the lip of the light housing and ease it away from the internal case of the fridge.

Remove the light globe.

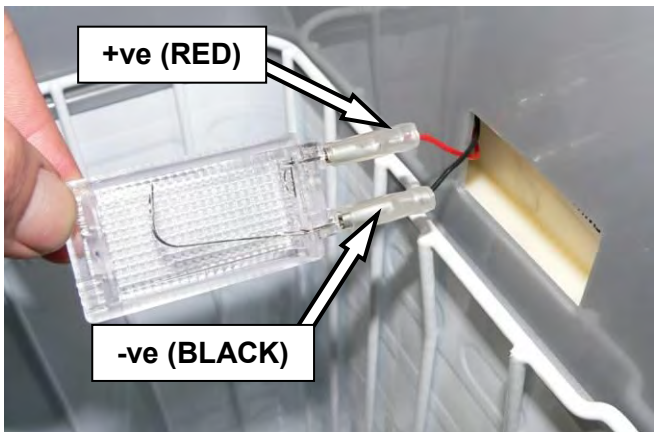

Disconnect positive (+ve) and negative (-ve) terminals from the light housing.

Discard the light housing.

Connect the positive and negative terminal to the new light housing.

NOTE: The positive and negative terminals can be connected to either terminal.



Refit the light globe. Ensure the LEDs inside the bulb are facing the transparent face of the light housing.

Test that the light functions correctly.

Reinstall the light assembly into the body of fridge.

9.12 Plug fuse (12/24V DC)- Replace

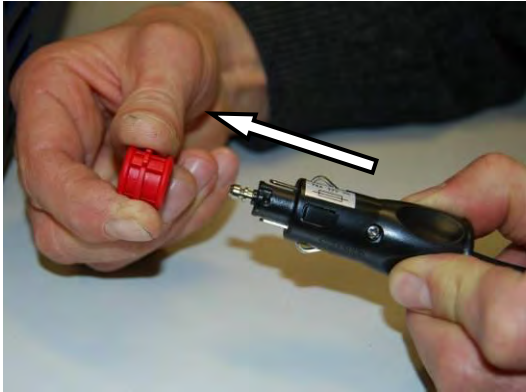
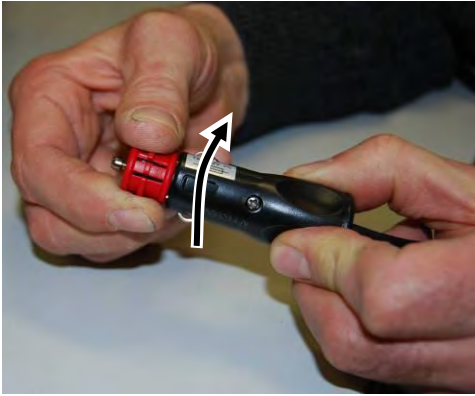

Disconnect the 12/24V DC power lead from the all power supplies.

If fitted, remove the plastic adaptor collar from the end of the plug To do this, twist the collar and then pull it from the plug.



Remove the single screw that fastens the plug together.

Separate and remove the top housing from the body of the plug.

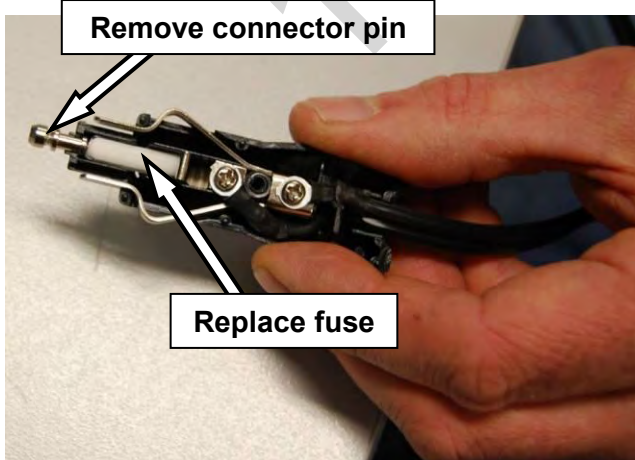

Remove the contact pin from the end of the plug.

Replace the device fuse with a new fuse of the same rating. The correct rating is T 8 Amp 32V.

Reassemble the plug and test its continuity.

9.13 Device fuse (100-240V AC) - Replace



Remove the AC and DC power leads from the power sockets.

Remove the fuse insert from the rear panel of the fridge as shown.

HINT: A small flat blade screwdriver may be required to help pry the insert away from its housing.



Replace the defective fuse with a new fuse that has the same rating. The correct rating for the fuse is 4A, specified as: F4L250V.

Replace the fuse insert back into its housing

9.14 DC power socket - Replace



Disconnect all power leads from the back of the fridge.

Remove the rear cover (refer to section [9.2](#)).

Remove the decal label from the power panel.

Withdraw the socket (complete with leads) through the hole in the rear cover as shown.

HINT: Use a flat blade screw driver to depress the tabs on the back of the socket.

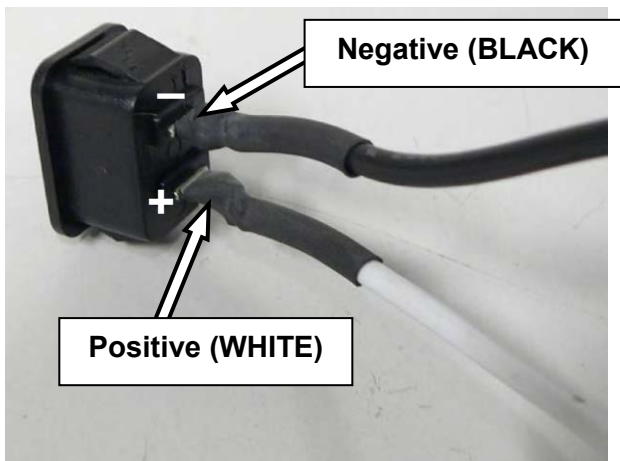

Disconnect the positive (white) and negative (black) wires from the terminals on the back of the DC socket using a soldering iron.

Connect the positive (white) and negative (black) wires to the new DC power socket using a soldering iron. The terminals on the back of the socket are labelled "+" (positive) and "-" negative.

IMPORTANT: Make sure that the wires are securely soldered to the correct terminals.

Apply heat shrink insulation to the exposed sections of wire.



Restore power to the fridge and confirm correct operation of the socket.

Refit the DC socket into the rear cover. Ensure that the locating boss faces the outside of the fridge as shown.

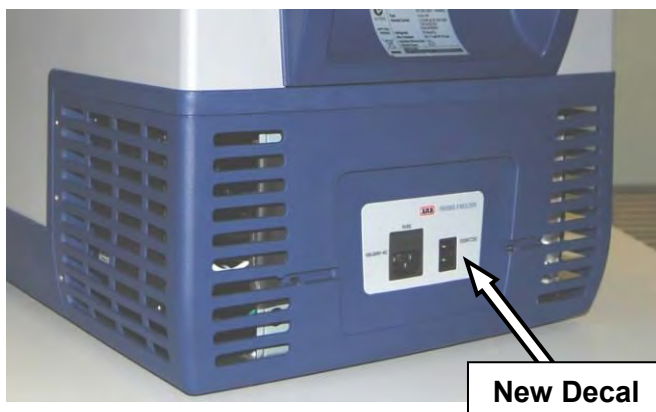

Refit rear cover.

CAUTION: When refitting cover, ensure that all cables are securely fastened away from sharp, moving or hot surfaces.

Apply a new decal to the power plate.

9.15 AC power socket - Replace

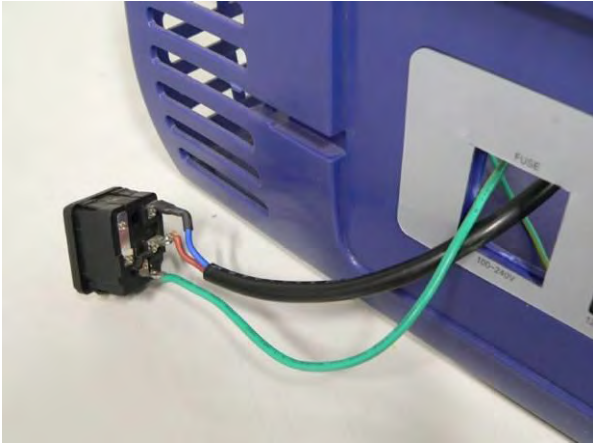

Disconnect all power leads from the back of the fridge.

Remove the rear cover (refer to section [9.2](#)).

Remove the AC socket protector.

Withdraw the socket (complete with leads) through the hole in the rear cover as shown.

HINT: Use a flat blade screw driver to depress the tabs on the back of the socket

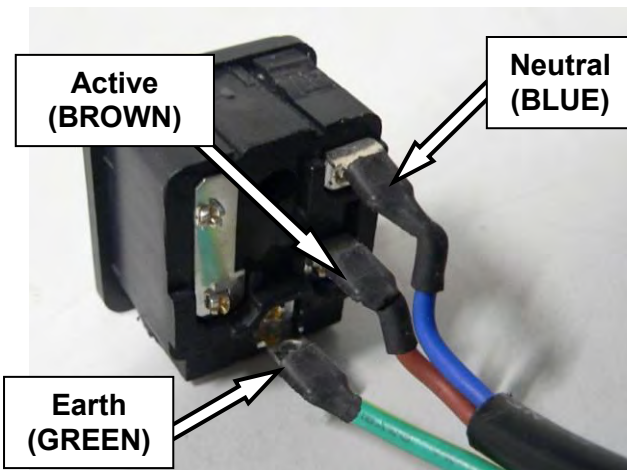

Disconnect the 3 wires from the back of the AC power socket using a soldering iron.

Connect the 3 wires to the new AC power socket using a soldering iron (refer to diagram for wiring details).

Apply heat shrink insulation to the exposed sections of wire.

NOTE: Termination of the AC cables to the AC socket should only be performed by a licensed electrician.

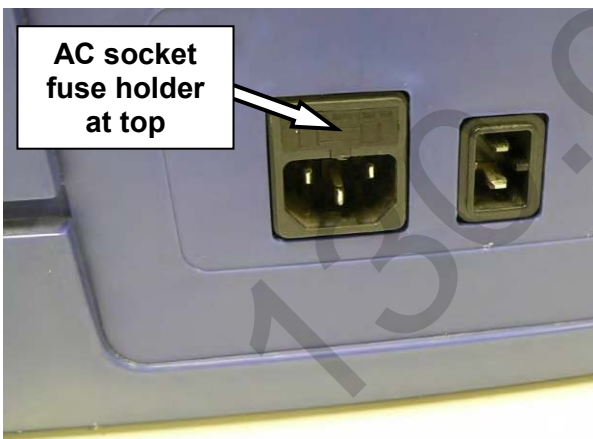

Refit the socket into the rear cover. Ensure that the fuse housing is at the top as shown.

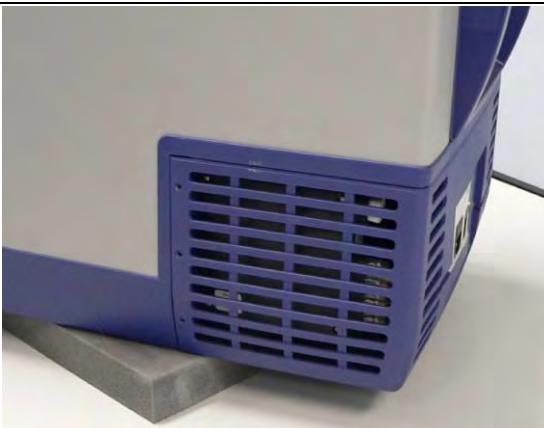





Refit the rear cover.

Restore power to the fridge and confirm correct operation of the socket.

CAUTION: When refitting cover, ensure that all cables are securely fastened away from sharp, moving or hot surfaces.

9.16 Rubber feet – Remove and Refit

 <p data-bbox="135 465 363 566">Remove M6 bolt</p>	<p data-bbox="794 170 1422 237">Remove 1 M6 bolt from the centre of the rubber foot using a 5 mm hex key.</p>
	<p data-bbox="794 663 1401 730">Remove the rubber foot from the recess in the base of the fridge.</p>
 <p data-bbox="127 1422 359 1523">Install new rubber foot</p>	<p data-bbox="794 1151 1417 1218">Install the new rubber foot into the recess in the base of the fridge.</p>
	<p data-bbox="794 1641 1409 1709">Fasten the rubber foot to the body of the fridge using the original M6 bolt.</p> <p data-bbox="794 1742 1422 1843">NOTE: When tightening the M6 bolt, do not exceed an assembly torque of 3.5 Nm (2.5 ftlb).</p>

9.17 Compressor mounting feet – Replace

To Remove compressor mounting feet



Disconnect all power leads from the back of the fridge.

Remove the rear cover (refer to section [9.2](#)).



Remove the retaining clip by sliding it sideways off the pin.

HINT: A flat blade screwdriver may be useful to help remove the retaining clip.

HINT: Press down on the steel compressor base to compress the rubber mounting bush.

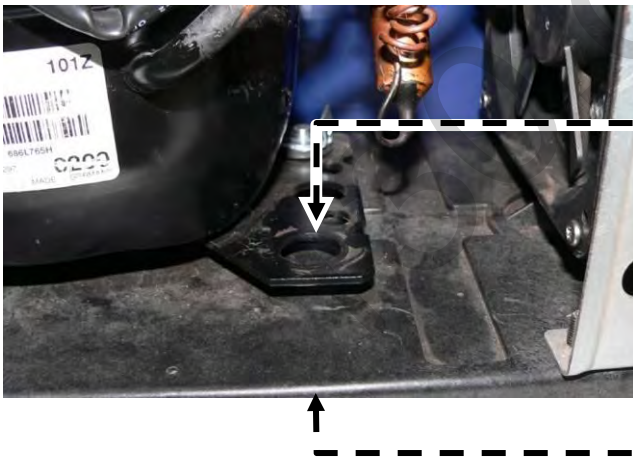

Withdraw the pin, washer and rubber bush.



To refit compressor mounting feet

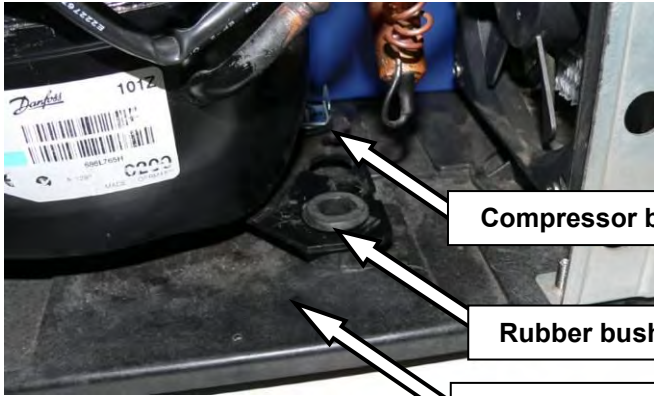

Locate the rubber bush between the steel compressor base and the mounting base as shown.

NOTE: *The small end of the rubber bush should locate within the steel base of the compressor.*

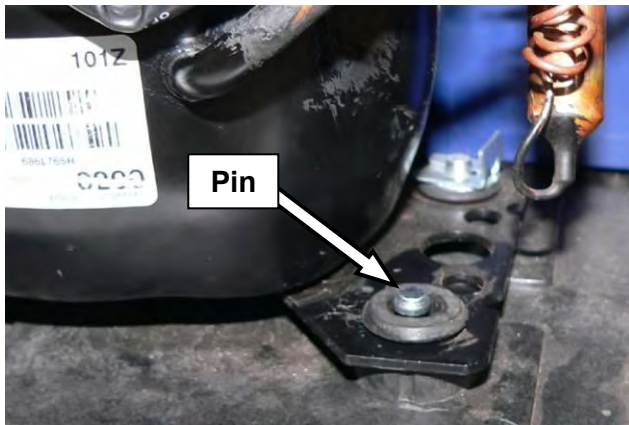
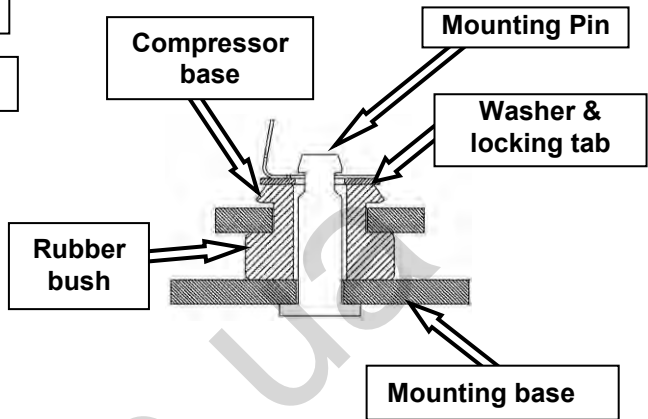

Insert the pin through the mounting base, steel compressor base and rubber bush.

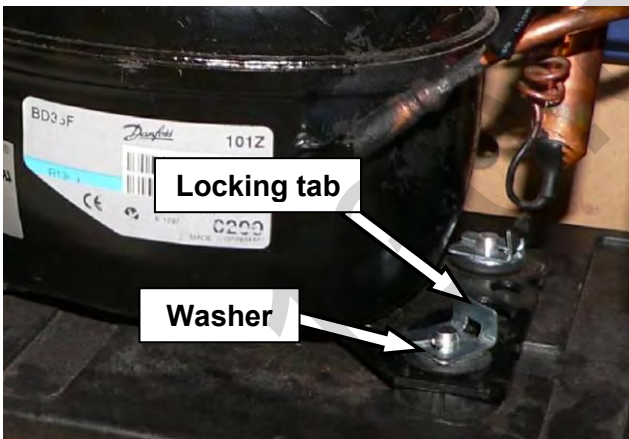

Place the washer over the pin and secure with the locking tab.

HINT: *Temporary compression of the rubber bush will assist with fitting the locking tab.*

HINT: *A small g-clamp may be useful to help compress the rubber bush.*

CAUTION: *When compressing the bush, take care not to damage the mounting base or the steel compressor base.*



Refit the rear cover.

Fasten the rear cover to the body of the fridge using the original 12 screws.

CAUTION: *When refitting cover, ensure that all cables are securely fastened away from sharp, moving or hot surfaces.*

9.18 Compressor mounting base - Replace

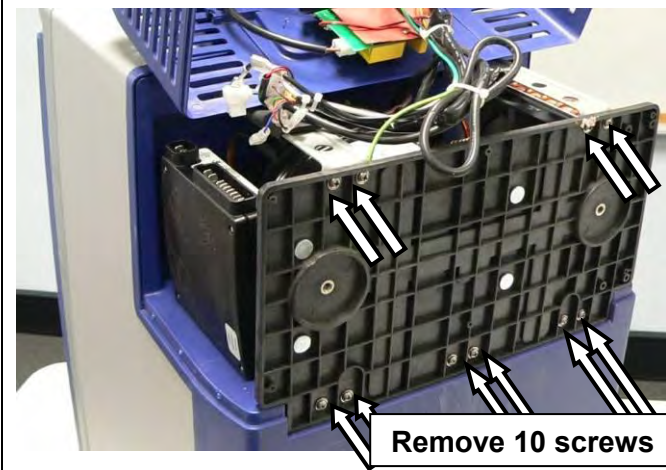

Disconnect all power leads from the back of the fridge.

Remove the rear cover (refer to section [9.2](#)).

Remove the 10 screws that attach the compressor mounting base to the body of the fridge.

NOTE: *The fridge has been rotated for photo only. ARB does not recommend placing the fridge on its end as shown.*



Lower the compressor mounting base (complete with compressor and condenser) from the base of the fridge.

Support the compressor mounting base so that it does not drop more than 100 mm below the base of the fridge.

CAUTION: *Take care not to stretch the refrigeration lines or power cables.*

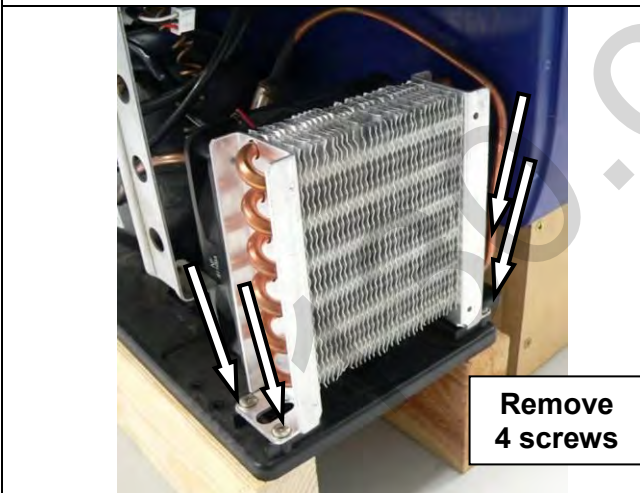

Remove 4 screws that fasten the condenser to the mounting base.

Separate the condenser and fan from the mounting base as a complete assembly.

CAUTION: *Take care when handling the condenser assembly not to stretch the refrigeration lines or power cables.*



Separate the compressor from the mounting base by releasing the 4 rubber compressor mounts (refer to section [9.17](#)).

CAUTION: *Take care when handling the compressor not to stretch the refrigeration lines or power cables.*

Remove 2
rubber feet

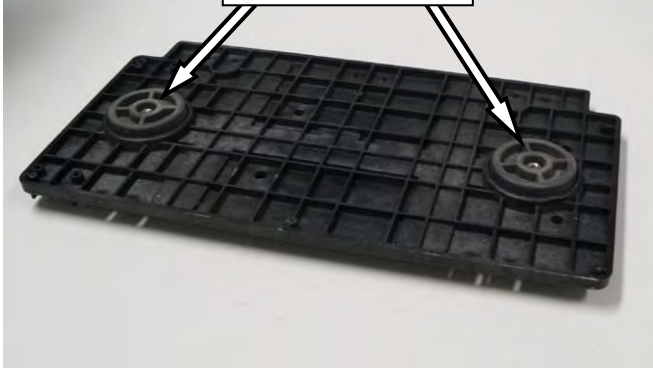

Remove the compressor mounting base the from fridge.

Remove 2 rubber feet from compressor mounting base. Retain both the rubber feet and the fastening bolts.

Discard old compressor mounting base.



Fit the 2 rubber feet to the new compressor mounting base using the original fasteners.

Fit the compressor, condenser and fan to the new mounting base using the original fasteners.



Fit the new mounting base (complete with compressor, condenser and fan) to the body of the fridge.

Fasten the mounting base using the 10 original fasteners.

Refit the rear cover.

CAUTION: When refitting the rear cover, ensure that all cables are securely fastened away from sharp, moving or hot surfaces.

9.19 Lid seal – Remove and Refit

Lid seal - To Remove

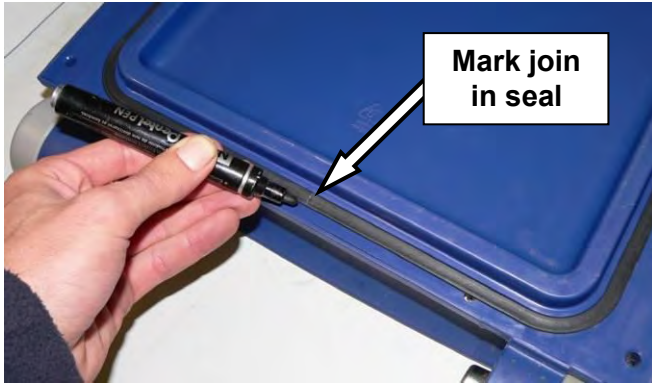

Locate and mark the join in the lid seal as shown.

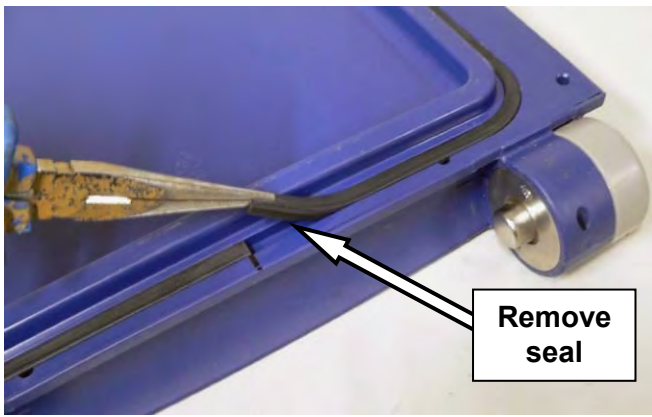

Using a pair of long nosed pliers, grip the seal and pull it away from the lid.

Lid seal - To Refit

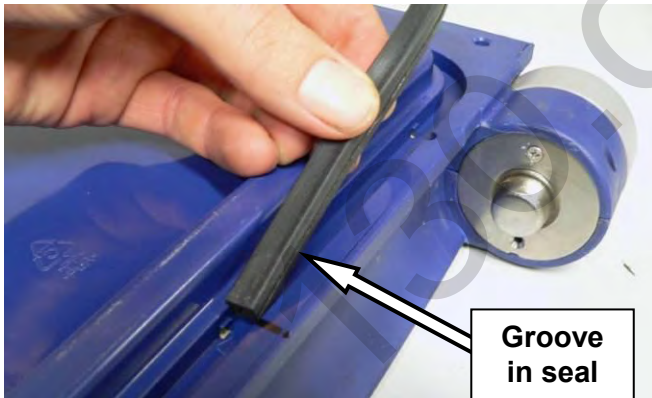

Starting at the marked point, press the seal into the groove.

NOTE: The seal should be orientated with the groove on the side as shown.

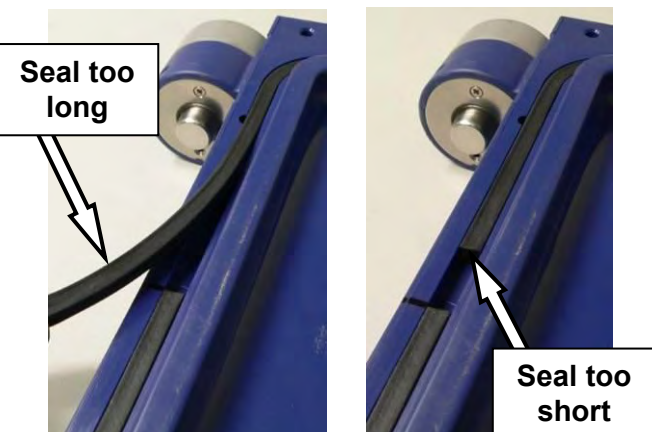

The lid seal is cut to the correct length and should fit exactly into the groove.

If the seal is too long, it may have been over-stretched. Remove the seal and refit it without stretching.

If the seal is too short, remove the seal and reinsert it while stretching it slightly.

9.20 Lid hinge assembly- Service

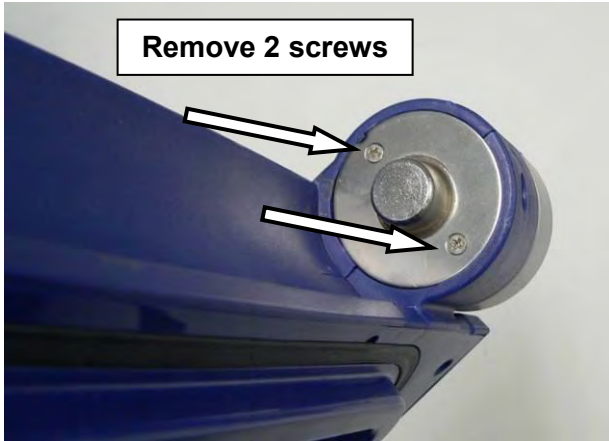

Remove the lid from the body of the fridge

Remove 2 screws as shown.

Remove the washer, hinge pin and hinge spring.

HINT: *Depress the hinge pin slightly and then release to dislodge the washer and eject the hinge.*



Clean the hinge pin and bore with a clean dry rag. Ensure that there is no foreign material in the bore.

Lubricate the outer surface of the hinge pin with a paraffin based dry lubricant.

Insert the spring and hinge pin into the bore.

For 60&78L models, do not refit the washers shown below.



Refit the large washer and fasten using the original 2 screws. Locate the notch in the washer with the boss in the lid as shown.



Press the hinge pin down so that the top of the pin is flush with the washer. This will centralise the spring within the bore.

NOTE: *A 'click' noise may be heard as the spring centralises in the bore.*

9.21 Cabinet hinge assembly- Service



Remove one screw from the centre of the hinge socket as shown.



Remove the hinge socket by sliding it towards the front of the fridge as shown.



Insert the new hinge socket into the rear handle assembly as shown.



Fasten the hinge socket to the handle assembly using the original screw.

9.22 Thermistor – Replace

Fridge with non-serviceable thermistors

The thermistor is non-serviceable on 47L fridges with serial numbers up to and including those listed in the table below. Please contact ARB for service advice for these fridges.

Part Number	Country	Serial Number
10800471	AUSTRALIA	07002739
10800472	UNITED STATES	07000450
10800473	EUROPE	08000472
10800474	SOUTH AFRICA	07000160

For fridges with serviceable thermistors

All 35L, 60L and 78L fridges have serviceable thermistors. All 47L fridges with serial numbers higher than those listed in the table above also have serviceable thermistors. Please follow the procedure below to replace a serviceable thermistor.

	<p>Disconnect all power leads from the back of the fridge.</p> <p>Remove the rear cover (refer to section 9.2).</p>
 <p>Screw and "P" clip</p>	<p>Remove and retain the screw, "P"-clip and sealing compound that retain the thermistor wire.</p> <p>This screw is located in the bottom right hand corner of the fridge cabinet as shown.</p> 

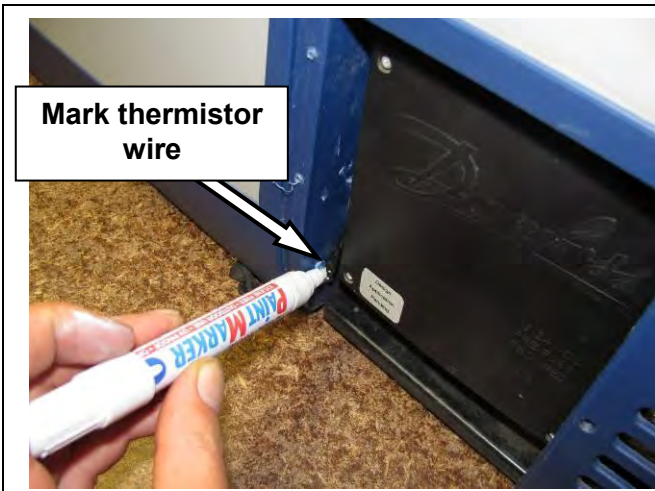

Place a mark on the thermistor wire where it exits the fridge cabinet as shown.



Withdraw the thermistor wire and thermistor from the fridge cabinet.

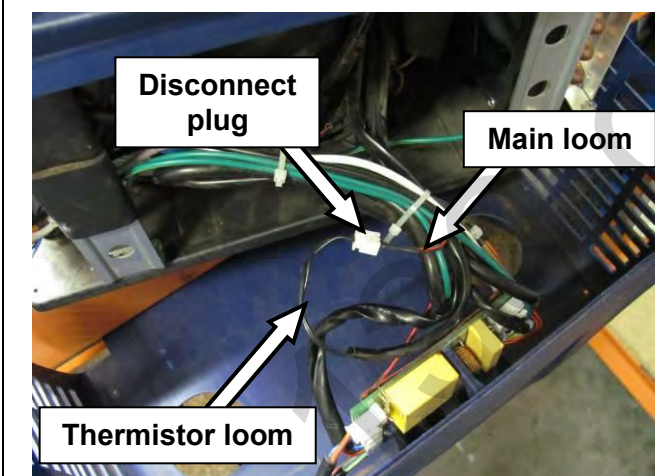

Disconnect the 2-pin connector from the end of the thermistor wire where it joins the main wiring loom.

Remove the thermistor wire (complete with thermistor) from the fridge. Take note of the thermistor wire path.

NOTE: It may be necessary to remove cable ties that have been used to secure the thermistor wire to the main wiring loom.

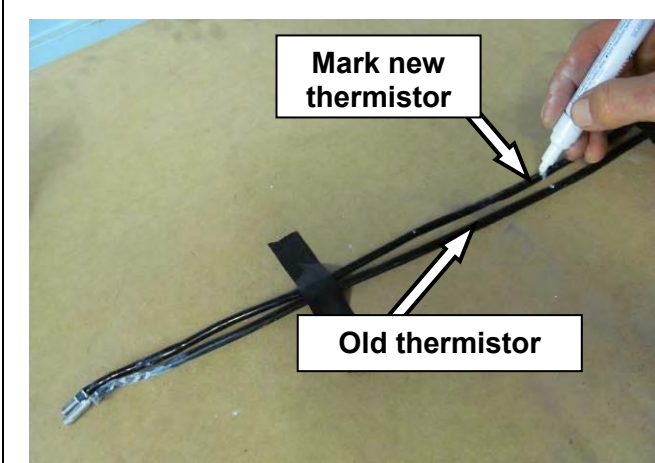

Place the old thermistor alongside the new one.

Transpose the mark made in the previous step from the old thermistor wire onto the new one.



Apply heat transfer paste

Apply thermal heat transfer paste to the metallic end of the thermistor as shown.

This paste is available from Jaycar (p/n NM-2012)

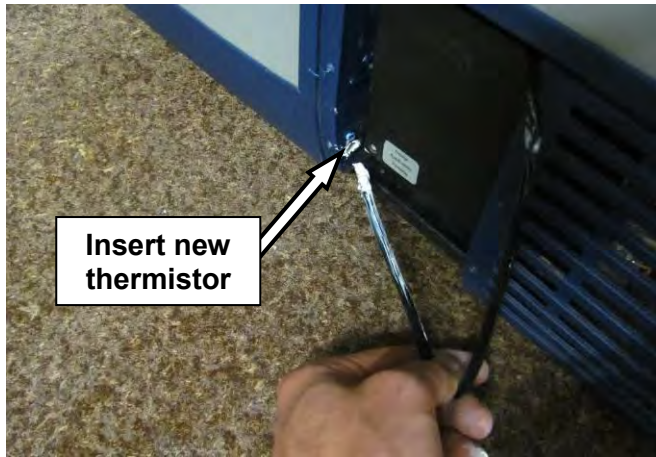

Insert new thermistor

Insert the new thermistor into the hole in the fridge cabinet.

Continue to insert the thermistor wire until the mark made in the previous step lines up with the body of the fridge.

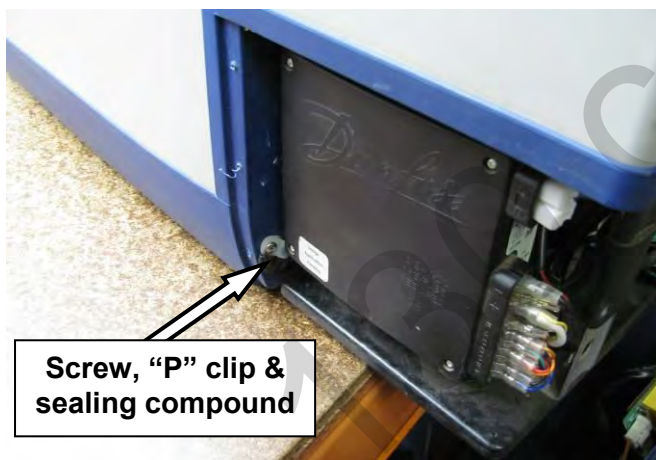

Screw, "P" clip & sealing compound

Secure the thermistor wire in place with the "P"-clip, screw and sealing compound.

Install the new thermistor wire into the fridge using the same path as the old wire.

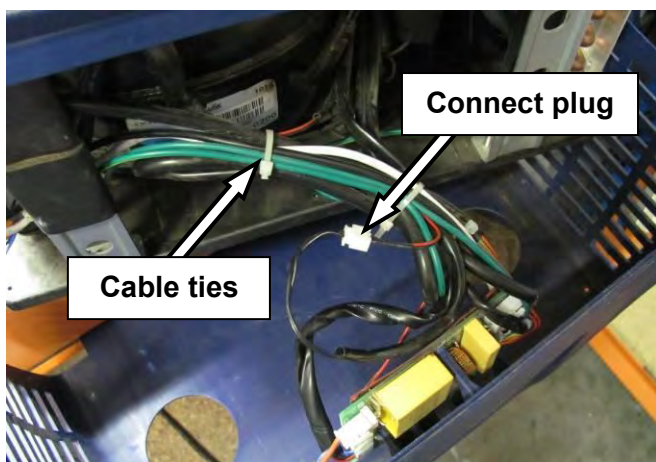

Cable ties

Connect plug

Connect the 2 pin connector to the main wiring loom.

Secure the thermistor wire main wiring loom using cable ties.

CAUTION: Ensure that all cables are securely fastened away from sharp, moving or hot surfaces.

Refit rear cover [9.2](#).

9.23 Improving performance with AM radios

The fitment of a braided wire (ARB p/n 10900023) can assist with AM radio clarity whilst the fridge compressor is running. To install this wire, please follow the instillation procedure below.



Disconnect all power leads from the back of the fridge.

Remove the rear cover (refer to section [9.2](#)).

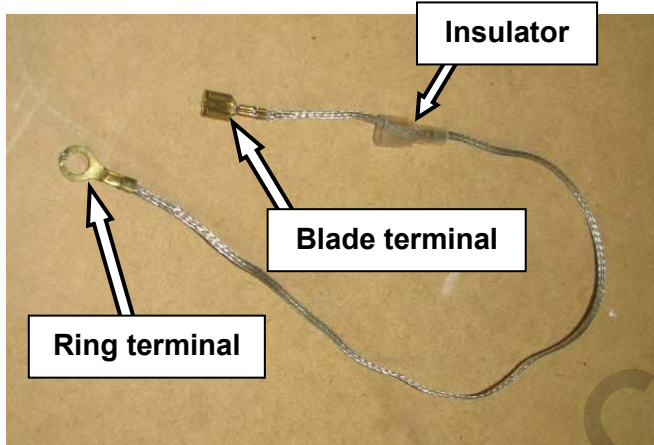

Crimp the supplied ring terminal to one end of the braided wire.

Crimp the supplied female blade terminal to the second end of the braided wire. Make sure that the plastic insulator is fitted over the wire before the terminal is crimped on.



Disconnect the push on connector from terminal "-" on the compressor control unit.

HINT: Use a pair of pliers to help release the connectors from the compressor control unit terminal.

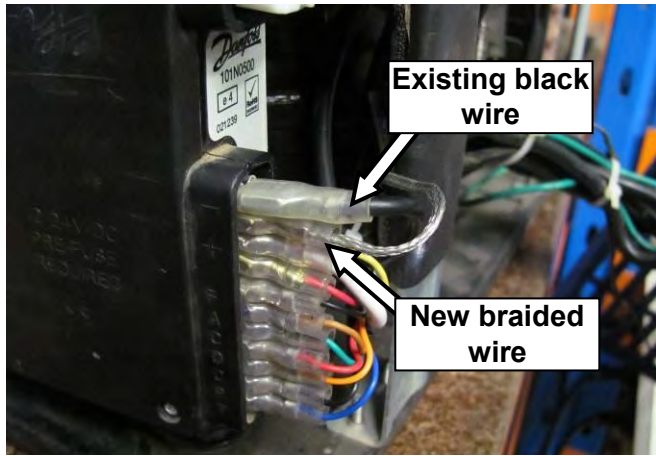

Fit the supplied 2-way connector to terminal “-” on the compressor control unit.

Connect the black wire and connector removed in the previous step to the 2-way connector.

Connect the blade terminal on the braided wire to the second terminal on the 2-way connector.

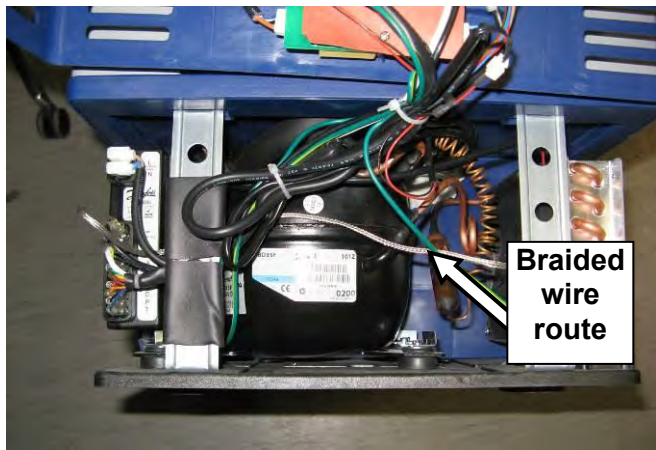

Route the braided wire along the main wiring loom as shown.

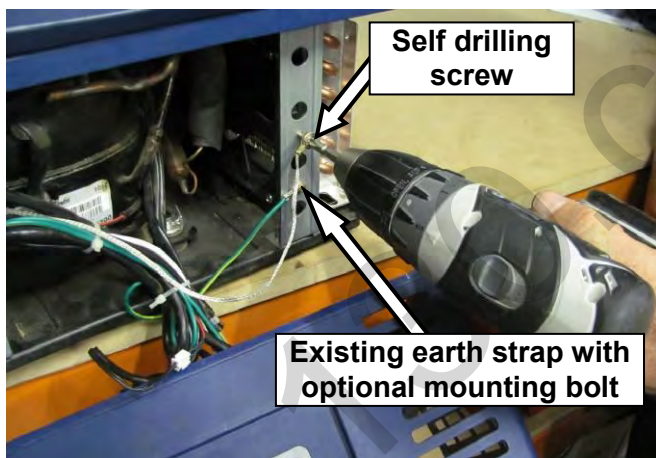

Fix the ring terminal on the braided wire to the steel frame of the fridge cabinet using the supplied self drilling screw as shown.

NOTE: *If the fridge already has an earth strap attached to this frame, the existing bolt can also be used to fasten the new braided wire.*

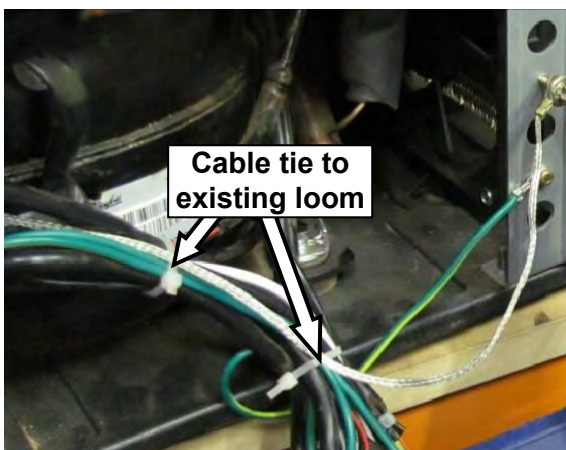

Secure the braided wiring to the existing wiring loom using the supplied cable ties.

CAUTION: *Ensure that all cables are securely fastened away from sharp, moving or hot surfaces.*

Refit rear cover [9.2](#).

9.24 Basket retention

The basket on the 78L (82 qt) fridge is fixed to the inside of the fridge cabinet via a ‘P’ clip and stainless steel screw. The basket divider is fixed to the basket with a plastic tie. Both of these features are required for regulatory compliance and must not be removed.

If the basket is rotated or temporarily removed for cleaning or service, the ‘P’ clip and stainless steel screw must be reinstalled to fix the basket in place.

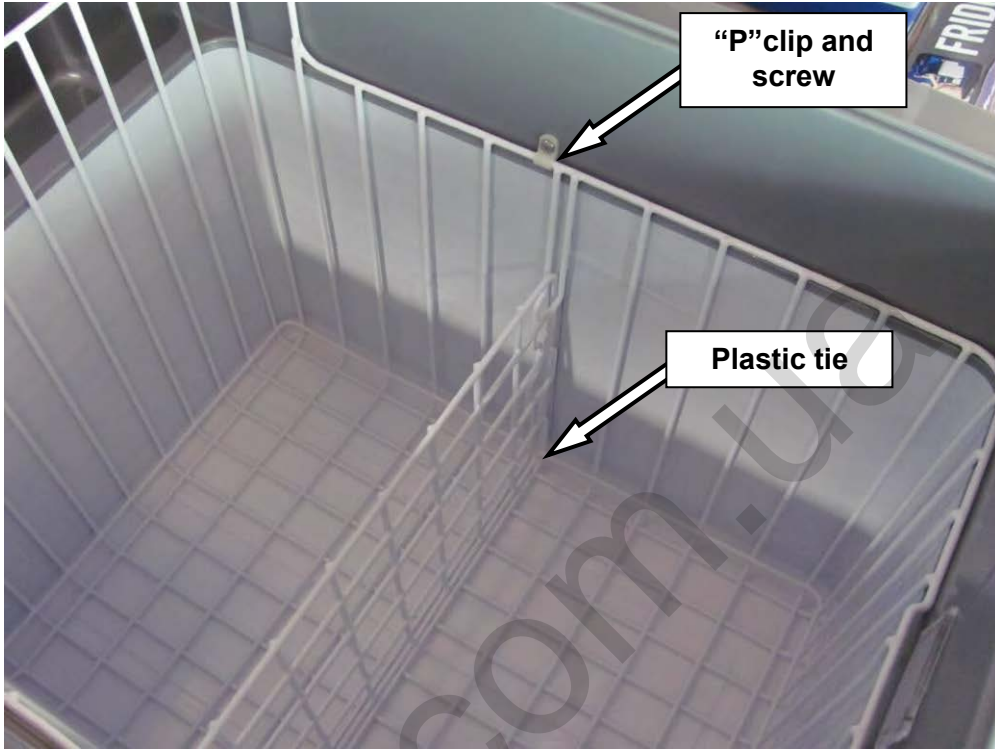

10 SERVICE BY REFRIGERATION MECHANIC

10.1 Compressor recharge information

The ARB fridge freezer range as designated in this manual use refrigerant R134a.

Model	47L(50 qrt)	35L(37 qrt)	60L(63 qrt)	78L(82 qrt)
Type	10800010	10800020	10800030	10800040
R134a g/(oz)	47/(1.66)	42/(1.48)	56/(1.98)	63/(2.22)

10.2 Leaks in the refrigerant system.

If low refrigerant is suspected, the system should be pressure tested.

If the pressure test identifies a leak, the location of the leak should be found.

To locate the leak, the refrigerant system should be split into two sections (see below) and pressure tested separately.

Section 1 - All refrigerant lines and components external to the foamed cabinet. This includes the compressor and condenser.

Section 2 - The evaporator and all refrigerant lines inside the foamed cabinet.

If the refrigerant leak is located externally of the evaporator and foamed cabinet (section 1), the leak may be repaired. If the fridge is inside the warranty period a complete replacement is required.

If a refrigerant leak is detected inside the evaporator or foamed cabinet (section 2), the fridge should be replaced.

11 WIRING

11.1 Wiring diagram-

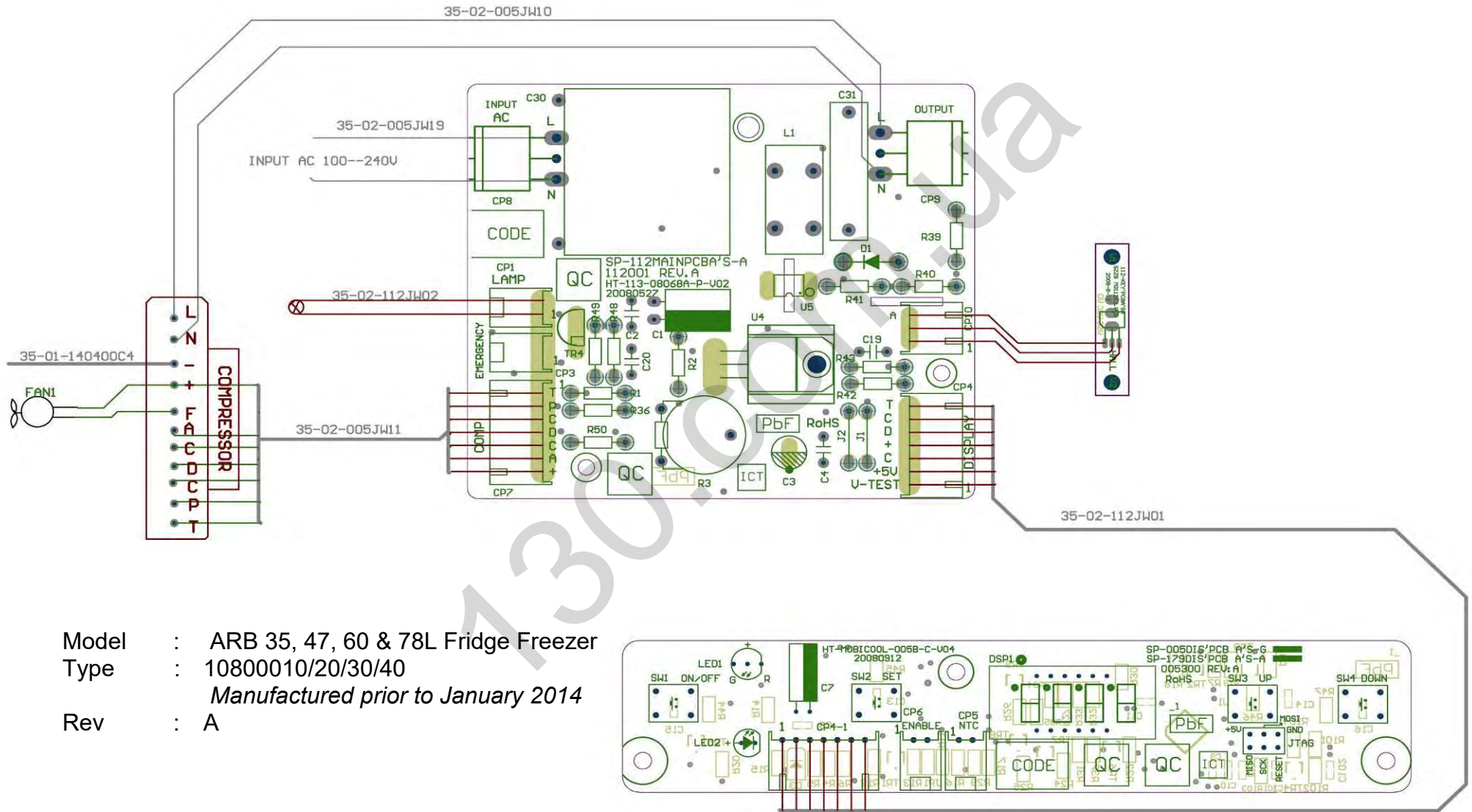

Model : ARB 35, 47, 60 & 78L Fridge Freezer
 Type : 10800010/20/30/40
 Manufactured prior to January 2014
 Rev : A

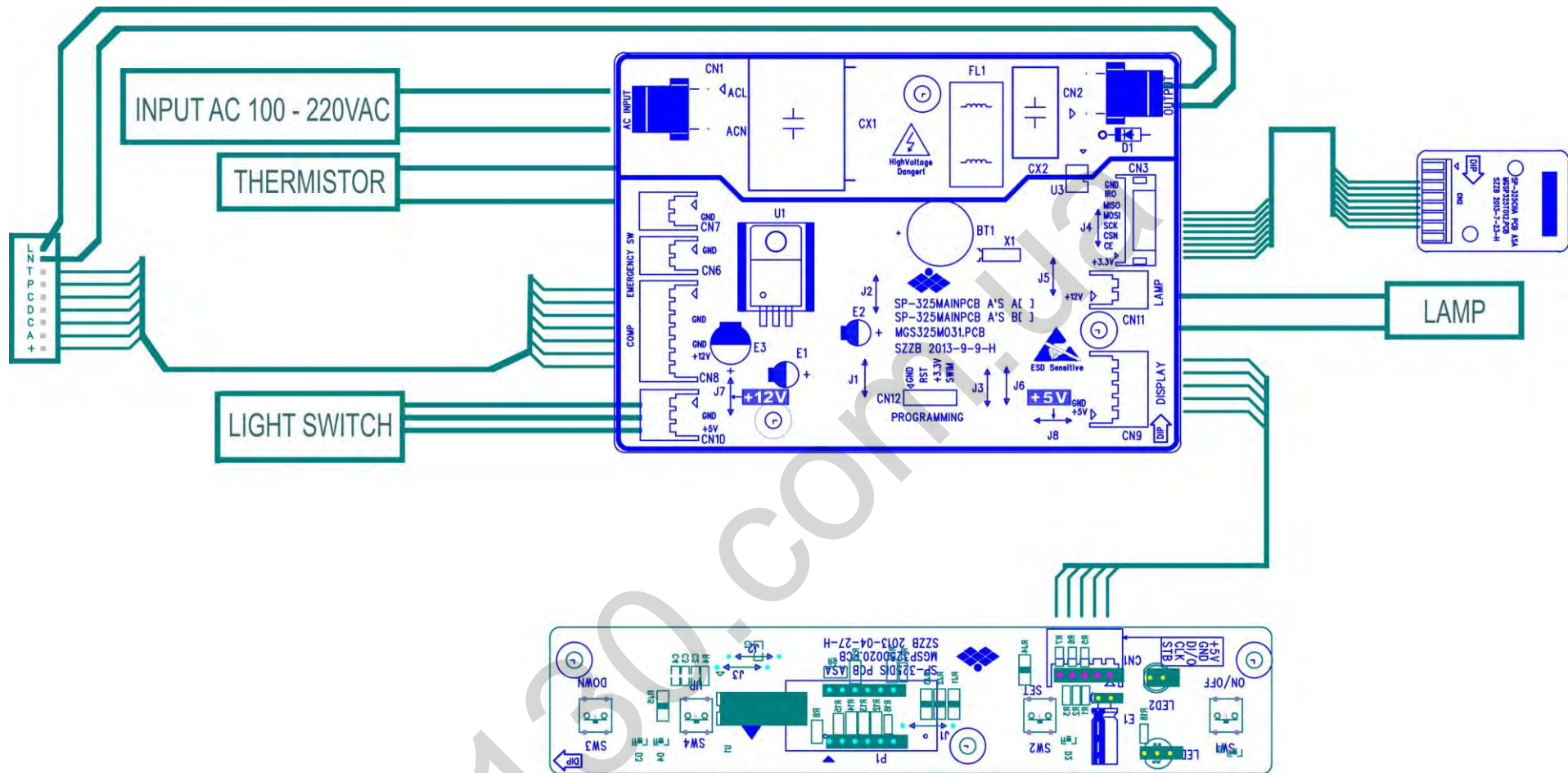

Model : ARB 35, 47, 60 & 78L Fridge Freezer
 Type : 10800010/20/30/40
 Manufactured after January 2014
 Rev : A

11.2 Wiring schematic

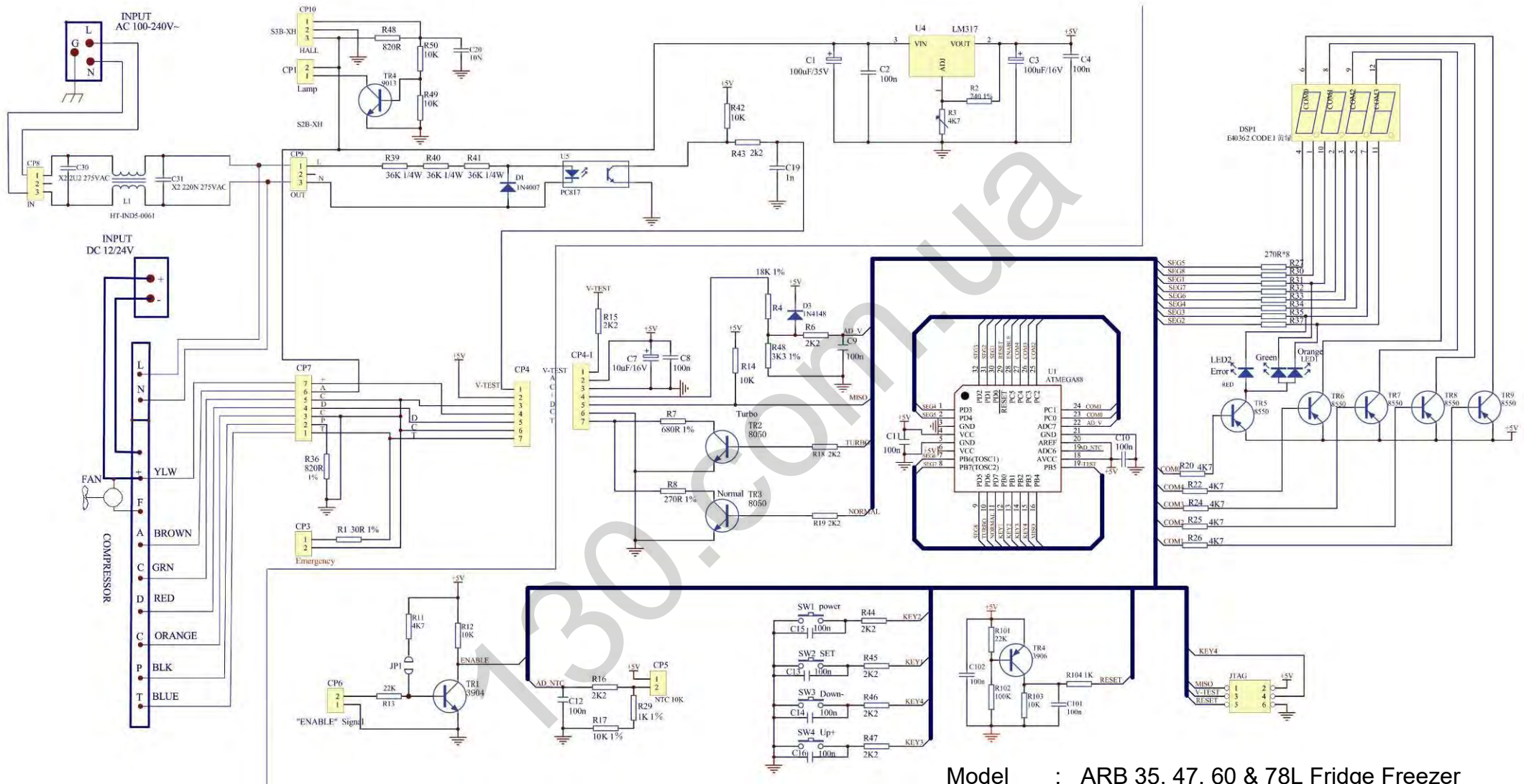

Model : ARB 35, 47, 60 & 78L Fridge Freezer
 Type : 10800010/20/30/40
 Manufactured prior to January 2014
 Rev : A

12 PRODUCT IMPROVEMENT CHANGE LOG

The following table contains the serial number breakpoints for specific product changes by fridge type.

NOTE: *At the time of publication, no product improvements have been made to models 10800XX6 or 10800XX7. This is because both models were introduced after the most recent product improvement was implemented.*

35L Type 10800020

		Model				
		10800351	10800352	10800353	10800354	10800355
		Australia	United States	Europe	South Africa	England/Middle East
Replace steel rivets with aluminium for evaporator Feb - 2012	Production Date	17/02/2012	8/03/2012	--	17/01/2012	--
	Serial Number	10001216	10000431	--	10000081	--
European ErP Documentation – Mar-2013	Production Date	N/A	N/A	22/03/2013	N/A	N/A
	Serial Number			11000133		
Introduction of new DC cord with screw-in plug Oct - 2013	Production Date	8/10/2013	8/10/2013	--	--	--
	Serial Number	11002556	11000884	--	--	--
Wireless Display Compatibility Jan - 2014	Production Date	4/01/2014	4/01/2014	--	--	--
	Serial Number	11002950	11000991	--	--	--

47L Type 10800010

		Model				
		10800471	10800472	10800473	10800474	10800475
		Australia	United States	Europe	South Africa	England/Middle East
Revised latch May-09	Production Date	--	--	--	--	--
	Serial Number	07001602	--	--	--	--
Serviceable thermistor Jul-09	Production Date	21/09/09	08/09/09	--	29/10/09	--
	Serial Number	07002740	0700451	08000473	07000161	--
Aluminum plate over evaporator – Jun-10	Production Date	--	--	--	--	--
	Serial Number	08006006	08001051	08000779	08000311	--
Front control panel housing update – Jun-10	Production Date	--	--	--	--	--
	Serial Number	08006006	08001051	08000779	08000311	--
Circuit Board White LED display - Jan-11	Production Date	--	--	--	--	--
	Serial Number	08006756	08001551	08000799	--	--
Replace steel rivets with aluminium for evaporator Feb - 2012	Production Date	7/02/2012	8/03/2012	--	17/01/2012	--
	Serial Number	10010186	10003466	--	10000711	--
European ErP Documentation – Mar-2013	Production Date	N/A	N/A	22/03/2013	N/A	N/A
	Serial Number	--	--	11000924	--	--
Introduction of new DC cord with screw-in plug Oct - 2013	Production Date	8/10/2013	8/10/2013	--	--	--
	Serial Number	11014836	11005643	--	--	--
Wireless Display Compatibility Jan - 2014	Production Date	4/01/2014	4/01/2014	--	--	--
	Serial Number	11016054	11006123	--	--	--

60L Type 10800030

		Model				
		10800351	10800352	10800353	10800354	10800355
		Australia	United States	Europe	South Africa	England/Middle East
Revised hinge spring Jan-2013	Production Date	22/01/2013	26/01/2013	14/03/2013	28/05/2013	2/07/2013
	Serial Number	11005071	11000317	11000041	11000287	11000060
Replace steel rivets with aluminium for evaporator Feb - 2012	Production Date	7/02/2012	8/03/2012	--	17/01/2012	--
	Serial Number	10002831	10000129	--	10000137	--
European ErP Documentation – Mar-2013	Production Date	N/A	N/A	22/03/2013	N/A	N/A
	Serial Number	--	--	11000041	--	--
Introduction of new DC cord with screw-in plug Oct - 2013	Production Date	8/10/2013	11/10/2103	--	--	--
	Serial Number	11006834	11000456	--	--	--
Wireless Display Compatibility Jan - 2014	Production Date	4/01/2014	4/01/2014	--	--	--
	Serial Number	11007840	12000581	--	--	--

78L Type 10800040

		Model				
		10800351	10800352	10800353	10800354	10800355
		Australia	United States	Europe	South Africa	England/Middle East
European ErP Documentation – Mar-2013	Production Date	26/01/2013	31/01/2013	14/03/2013	25/05/213	2/07/2013
	Serial Number	11002194	11000257	11000028	11000281	11000011
Introduction of new DC cord with screw-in plug Oct - 2013	Production Date	7/02/2012	8/03/2012	--	17/01/2012	--
	Serial Number	10001386	10000119	--	10000101	--
Wireless Display Compatibility Jan - 2014	Production Date	N/A	N/A	22/03/2013	N/A	N/A
	Serial Number	--	--	11000028	--	--
Introduction of new DC cord with screw-in plug Oct - 2013	Production Date	11/10/2013	11/10/2013	--	--	--
	Serial Number	11002901	11000328	--	--	--
Wireless Display Compatibility Jan - 2014	Production Date	4/01/2014	4/01/2014	--	--	--
	Serial Number	11003255	12000368	--	--	--

12.1 Definition of change:

Front control panel housing update – Jun-10

The housing change now incorporates a larger Touch Pad (p/n 10910041) and the Support – control panel has been obsolete from the design. The larger touchpad can be modified/trimmed to fit earlier (refer serial number breakpoint) fridges. The original touch pad (p/n 10910026) is NOT forward compatible with new fridges. Sufficient quantities of inventory have been ordered to cater for service needs.

Circuit Board White LED display - Jan-11

The 47 Litre model was initially launched with a green LED display. When the new fridge range was developed we decided a new bright white LED better suits the customer needs in all lighting conditions. The new white LED circuit board is backward compatible with all ARB fridges. Note: do NOT use the green LED on 35, 60 or 78L fridge models.

New DC cord with screw-in plug – Oct 2013

The original Fridge DC Lead with a Cig/Merit combination plug was replaced with a new Cig/Screw –In plug. The screw-in plug is compatible with the ARB Screw-In DC socket. The new DC lead is backward compatible with all ARB Fridges manufactured before October 2013. The original DC lead has been discontinued.

Remote Display Compatibility – Jan 2014

New Main and Display PCBs were introduced with the introduction of the ARB Remote display. The new PCBs are not forward or backward compatible as the communication looms are different. It is not possible to upgrade an ARB fridge manufactured prior to January 2014 to use these new PCB. When servicing fridges manufactured prior to January 2014, the original parts numbers listed in section 4 must be used. At this time, a change was also made to the PCBs so that the interior light will not operate unless the fridge is turned on using the ON/OFF button on the front of the fridge.

12.2 Superseded products:

The following table may assist you with the identification and use of superseded spare parts. As of February 2011, the part number nomenclature changed to replace prefix 1092xxxx with 1091xxxx to improve picking accuracy.

New ARB Part No	Old/Superseded ARB Part No.	ARB Description	Old P/N forward compatible with New P/N	New P/N backward compatible with Old P/N
10910051	10920001	SPRING KIT - LID HINGE 35/47L	Yes	Yes
10910052	10920023	SPRING KIT - LID HINGE 60/78L	Yes	Yes
10910053	10920002	SOCKET KIT - LID HINGE	Yes	Yes
10910054	10920005	HANDLE ASSY KIT - REAR 47/78L	Yes	Yes
10910055	10920025	HANDLE ASSY KIT - REAR 35/60L	Yes	Yes
10910056	10920004	SCREW KIT - REAR HANDLE ASSY	Yes	Yes
10910057	10920003	PLUG KIT-REAR HANDLE ASSY47/78L	Yes	Yes
10910059	10920006	SCREW KIT - CONDENSOR AND FAN	Yes	Yes
10910060	10920011	SCREW KIT - MOUNTING BASE	Yes	Yes
10910061	10920012	MOUNTING BASE 35/47L	Yes	Yes
10910062	10920024	MOUNTING BASE 60/78L	Yes	Yes
10910063	10920007	MOUNTING KIT - COMPRESSOR	Yes	Yes
10910064	10920010	SCREW KIT - REAR COVER	Yes	Yes
10910065	10920008	SCREW KIT - MAIN CIRCUIT BOARD	Yes	Yes
10910066	10920009	CIRCUIT BOARD - MAIN	Yes	Yes
10910067	10920013	RUBBER FOOT KIT	Yes	Yes
10910068	10920014	PLUG KIT - FRONT HANDLE ASSY	Yes	Yes
10910069	10920015	SCREW KIT - FRONT HANDLE ASSY	Yes	Yes
10910070	10920018	FRONT HANDLE ASSY KIT	Yes	Yes
10910071	10920017	SCREW KIT - LATCH	Yes	Yes
10910072	10920016	LATCH ASSY	Yes	Yes
10910073	10920019	SCREW KIT - CONTROL PANEL	Yes	Yes
10910074	10920021	HOUSING KIT - LIGHT	Yes	Yes
10910075	10920020	DRAIN PLUG KIT	Yes	Yes