



PHONES

(044) 360-7-130
(050) 336-0-130
(063) 788-0-130
(067) 233-0-130
(068) 282-0-130

130 Internet store of autogoods

COM.UA



ICQ
294-0-130
597-0-130

SKYPE
km-130

CAR RECEIVERS — Receivers • Media receivers and stations • Native receivers • CD/DVD changers • FM-modulators/USB adapters • Flash memory • Facia plates and adapters • Antennas • Accessories |
CAR AUDIO — Car audio speakers • Amplifiers • Subwoofers • Processors • Crossovers • Headphones • Accessories | TRIP COMPUTERS — Universal computers • Model computers • Accessories |
GPS NAVIGATORS — Portable GPS • Built-in GPS • GPS modules • GPS trackers • Antennas for GPS navigators • Accessories | VIDEO — DVR • TV sets and monitors • Car TV tuners • Cameras • Videomodules
• Transcoders • Car TV antennas • Accessories | SECURITY SYSTEMS — Car alarms • Bike alarms • Mechanical blockers • Immobilizers • Sensors • Accessories | OPTIC AND LIGHT — Xenon • Bixenon • Lamps
• LED • Stroboscopes • Optic and Headlights • Washers • Light, rain sensors • Accessories | PARKTRONICS AND MIRRORS — Rear parktronic • Front parktronic • Combined parktronic • Rear-view mirrors
• Accessories | HEATING AND COOLING — Seat heaters • Mirrors heaters • Screen-wipers heaters • Engine heaters • Auto-refrigerators • Air conditioning units • Accessories | TUNING — Vibro-isolation
• Noise-isolation • Tint films • Accessories | ACCESSORIES — Radar-detectors • Handsfree, Bluetooth • Windowlifters • Compressors • Beeps, loudspeakers • Measuring instruments • Cleaners • Carsits
• Miscellaneous | MOUNTING — Installation kits • Upholstery • Grilles • Tubes • Cable and wire • Tools • Miscellaneous | POWER — Batteries • Converters • Start-charging equipment • Capacitors
• Accessories | MARINE AUDIO AND ELECTRONICS — Marine receivers • Marine audio speakers • Marine subwoofers • Marine amplifiers • Accessories | CAR CARE PRODUCTS — Additives • Washer fluid •
Care accessories • Car polish • Flavors • Adhesives and sealants | LIQUID AND OIL — Motor oil • Transmission oil • Brake fluid • Antifreeze • Technical lubricant



In store "130" you can find and buy almost all necessary goods for your auto in Kyiv and other cities, delivery by ground and postal services. Our experienced consultants will provide you with exhaustive information and help you to chose the very particular thing. We are waiting for you at the address

<http://130.com.ua>

OWNER'S MANUAL
GT-435Xi
LASER/RADAR DETECTOR

THE WHISTLER GROUP, INC.
CORPORATE HEADQUARTERS
3604 NW Frontage Rd.
Bentonville, AR 72712
TEL: 479.273.6012 FX: 479.273.2927

© The Whistler Group, Inc. 2012

www.whistlergroup.com



If you have questions concerning the operation of this Whistler product please call:

CUSTOMER SERVICE
479-273-6012

Monday - Friday • 8:00 am - 5:00 pm CT USA

or visit our website

www.whistlergroup.com

Please keep the receipt in a safe place.

You may register your product online at www.whistlergroup.com. For warranty verification purposes, a copy of your dated store receipt must still accompany any unit sent in for warranty work. If the unit is returned without a dated store receipt an out of warranty service charge applies.

Note: Your warranty period begins at the time of purchase. The warranty is validated **only** by the dated store receipt! Now is the time to record the serial number of the unit in the space provided in the warranty section of the manual.

INTRODUCTION

Dear Whistler Customer,

Whistler has added new features made specifically for the International market. This model not only packs features common with Whistler's high end models such as LSID but also includes the following new features not found in USA models;

- Ka Narrow
- Adjustable Laser Segments (which include: TraffiPatrol XR, Riegl, Jenoptik, Laveg, Truespeed and laser guns with "Stealth" modes)
- X/K Filter modes
- Ka Filter modes

To utilize your unit to its full potential, we recommend reading this entire manual or visit our FAQ page on our web site www.whistlergroup.com.

Enjoy your new Whistler and please drive safely.

Sincerely,

The Whistler Group, Inc.

TABLE OF CONTENTS

Model Features Summary	4 - 5
Installation	6 - 9
• Mounting Guidelines	
• Windshield Mounting	
• Power Cord Connection	
• Fuse Replacement	
Operation	10 - 22
• Power On and Self-Test	
• Memory/Beep Confirmation	
• Auto Level Adjustment	
• Auto Quiet/Quiet Modes	
• Highway Mode	
• City/City 1/City2 Modes	
• Signal Strength Meter	
• Alert Periscopes	
• Dim/Dark Modes	
• VG-2 Mode	
• Vehicle Battery Saver Mode	
• Teach/Tutorial Mode	
• X/K Filter Mode	
• Ka Filter Mode	
• Setting Saver	
• Ka Narrow Mode	
• Laser Signature ID (LSID)	
• Adjustable Laser	
• POP™ Mode Detection	
• Safety Warning System SWS	
• Alert Priority	
• Option Select Mode	
• Stay Alert™	

TABLE OF CONTENTS

Radar/Laser Alerts	23
• Radar Alerts	
• Laser Audio/Visual Alerts	
• Pulse Protection®	
Reset Features	24
Care and Maintenance	25
Troubleshooting Guide	25 - 26
Speed Monitoring Technologies	27 - 30
• Are Detectors Legal?	
• POP™ Mode	
• Laser Facts	
• Laser Tips	
• Radar Facts	
• Other Speed Detection Systems	
• Radar Detector Detectors	
FCC Information	30
Warranty Information	31 - 34
Specifications	34
Accessories	35

FEATURES

FEATURES

Feature Listings of GT-435Xi

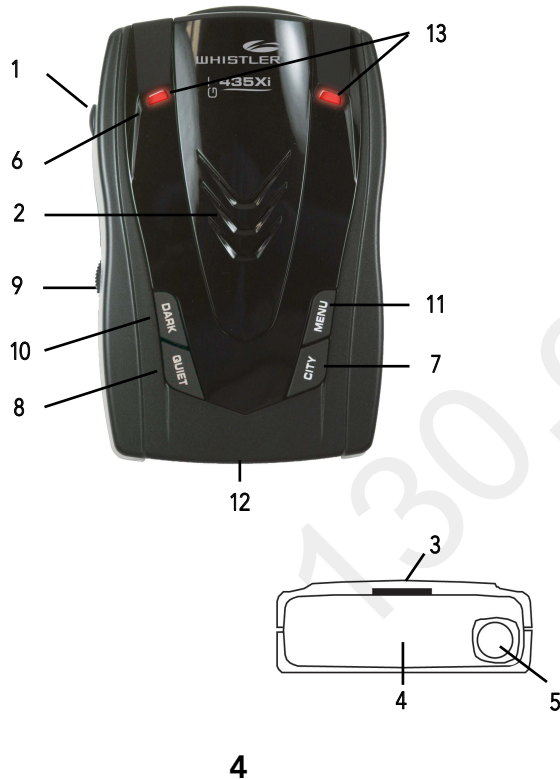

Whistler's ergonomic and user-friendly design provides a new level of operating convenience. Special features include:

1. **Bracket Release Button** – provides quick and easy release of the mounting bracket.
2. **Speaker** – provides distinct audio warnings for X, K, Ka band radar, Safety Warning System, and laser.
3. **Mounting Bracket Location** – slot holds mounting bracket firmly.
4. **Radar Antenna** – compact, high-efficiency antenna receives radar signals.
5. **Front Laser** – high gain optical lens provides increased sensitivity and field of view for leading-edge laser detection.
6. **Rear Laser** – an integrated optical waveguide provides superior detection of laser signals transmitted from behind.
7. **City Button** - reduces the annoyance of false alerts typically encountered in urban driving areas.
8. **Quiet Button** - pressing QUIET before a signal is detected engages Auto Quiet Mode which automatically reduces the audio level after the initial warning to a low audio level setting. Pressing QUIET during a radar/laser encounter silences audio alerts, while allowing visual alerts to keep you informed.
9. **Power / Volume Control** – turns the unit on/off and adjusts the audio level.
10. **Dim / Dark** - engages Dim/Dark modes.
11. **Menu Button** - enters Option Select Mode.
12. **Red OLED Text Display** – provides better contrast, brightness and color/shows alerts detected, signal strength, and indicates engaged modes of operation.
13. **Alert Periscopes** - provide an additional attention getting visual alert.

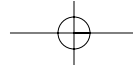

INSTALLATION

Mounting Guidelines

- Mount the unit as low as possible near the center of the windshield.
- Do not mount the unit behind wipers, ornaments, mirrored sunscreens, etc. These obstructions have metal surfaces which can affect radar and laser signals and reduce critical warning time. (Regular tinted glass does not affect reception).
- Some windshields have an Instaclear™ or Electriclear™ type coating, which affect radar signals. Consult your dealer or the owner's manual supplied with your vehicle to determine if your windshield has this coating.
- Avoid placing the unit in direct contact with the windshield.
- To reduce the possibility of theft, conceal the unit when not in use.

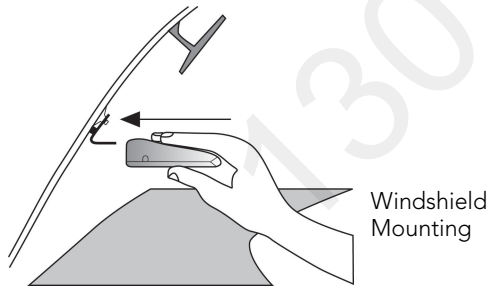

IMPORTANT: Make sure the unit is level

6

INSTALLATION

Windshield Mounting

- Install the two suction cups and rubber bumper onto the bracket by fitting them into their holes.
- Press the suction cups onto the windshield at the location you have chosen.

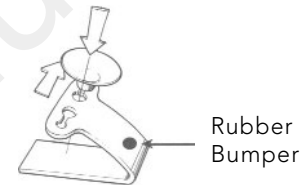

Important: Some newer cars have a plastic safety coating on the inside of the windshield. The windshield bracket may leave permanent marks on this type of surface. To find out if your vehicle has this type of windshield, check the vehicle's owner's manual or ask your dealer. We recommend that you do not leave the suction cup bracket on the window in direct sunlight. If the detector is removed, this may cause blistering of the dash in some vehicles.

- Slide the detector onto the bracket until it locks into place.
- If necessary, the unit may be leveled by bending the windshield bracket. Press the bracket release button and remove the detector before bending.

7

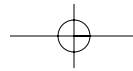

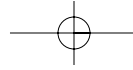

INSTALLATION

Power Cord Connection

- Plug the small end of the power cord into the unit's power jack.
- Plug the large end into the vehicle's cigarette lighter socket.

Note: Cord fits tightly into detector. When installing the cord, expect some resistance.



8

INSTALLATION

Fuse Replacement

The lighter socket plug is equipped with a replaceable 2 amp, 3AG fuse located behind the silver tip. To replace the fuse, carefully unscrew the tip of the plug.

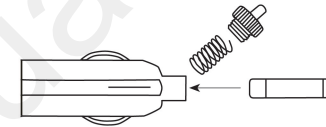

Important: Unscrew slowly. The tip contains a spring which may fly out when disassembling. Insert the new fuse with the spring and screw on the tip. With use, screw cap on plug may loosen. **Retighten occasionally.**

9

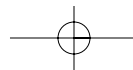

OPERATION

Power On and Self-Test

Each time your Whistler detector is turned on, an automatic self-test sequence confirms that the speaker, visual displays are functional along with many of the saved settings. To increase the volume, continue turning the volume knob.

Memory/Beep Confirmation

All features selected (except Stay Alert and Quiet) are retained in memory. Each time a button is pressed one beep confirms feature "on", two beeps confirm feature "off".

Audio Level Adjustment

To change the audio level:

- Move Power/Volume button back to increase audio level.
- Move Power/Volume button forward to decrease audio level.

10

OPERATION

Auto Quiet Mode

Auto Quiet mode provides an alternate alert pattern approximately 5 seconds after a radar or safety warning system signal is detected followed by clicking. The clicking will continue for as long as the detected signal is present and for any new signal within 20 seconds. Auto Quiet mode does not affect laser alerts.

- Press Quiet (before a signal is detected) to engage Auto Quiet mode.

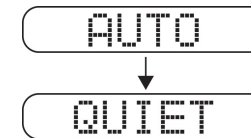

- Once the Auto Quiet mode is engaged, you may cancel the audio alarm by pressing Quiet.
- Press Quiet (when the unit is not alarming) to cancel Auto Quiet mode.

Quiet Mode

Quiet mode cancels audio during an alert and any new alert within 20 seconds. After 20 seconds of no radar signal detected, the audio alerts are restored.

- Press Quiet to cancel the audio.
- Press Quiet a second time during an alert to restore the standard audio alert pattern.

11

OPERATION

Highway Mode

Highway mode provides full audio warnings any time radar (X, K, Ka, and Safety Warning System - SWS) or laser signals are detected, and is recommended for open road driving.

For more information on City and Highway modes, please visit our FAQ page on our website: www.whistlergroup.com

City/City 1/City 2 Modes

Whistler's City Modes are designed to reduce the annoyance of automatic door openers, intrusion alarms and other devices which share frequencies with police radar. Generally, X band is used for these devices.

- Press City to cancel Highway Mode and engage City Mode.
- Press City again to enter City 1 Mode.
- Press City again to enter City 2 Mode.
- Press City a fourth time to cancel City 2 Mode and returns the unit to Highway Mode.

In City Mode, weak speed/safety radar signals give an initial alarm of two beeps, and then remain quiet until the signal becomes very strong. When the signal strength increases, two additional beeps are provided. City 1 and City 2 Modes operate the same as Highway Mode, but in City 1 Mode, only the X band is lowered. In City 2 Mode, X-band is not detected.

Caution: Some towns/small cities may still be using X band radar. City Modes do not change the audio alert for laser.

12

OPERATION

Signal Strength Display

When a radar signal is detected the audio alerts have a geiger counter-like pattern to help you determine the strength of the radar source; the faster the beeping the stronger the radar signal. At the same time the audio is reporting, the display illuminates the band identification Icon and relative signal strength from 1 to 9.

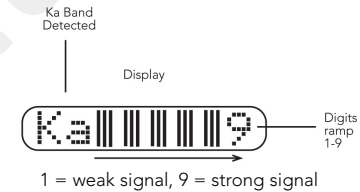

Alert Periscopes

Whistler's Alert Periscopes provide an added attention getting visual alert. The two extra LEDs flash on and off when the unit alarms to provide a unique visual alert. This alert can be programmed, through the Option Select Mode to:

1. flash for all alarms
2. remain on
3. turn LEDs off completely

13

OPERATION

Dim/Dark Modes

Dim/Dark Mode reduces the illumination of the display.

- Briefly press and release the Dark button to reduce illumination to a Dim setting.

DIM

- Briefly press and release the Dark button a second time engages Dark Mode. In Dark Mode, the display goes dark for as long as a signal is being detected and for 20 seconds after, then the display returns to the dim setting. Dim Modes can be engaged during an alert.

DARK

- Briefly press and release the Dark button a fourth time to restore full illumination to the display.

VG-2 Mode

See Option Select Mode to turn this feature on/off. When a VG-2 signal is detected, the VG-2 alert is sounded and the display flashes "VG-2". After 3 seconds the audio is canceled and the display no longer flashes. This cycle is repeated if the VG-2 signal is detected again.

During the period a VG-2 signal is detected, a radar signal cannot be detected.

However, because the VG-2 alert has confirmed that a patrol car is nearby, you are already aware of the potential for speed monitoring and can adjust your speed accordingly. Laser detection is not affected while a VG-2 signal is detected. (See page 29 for more information)

14

OPERATION

Vehicle Battery Saver Mode

The Vehicle Battery Saver Mode automatically shuts off the detector after 3 hours if the unit has constant power.

The timer is reset:

1. Each time the detector is turned off
2. The power cord is disconnected or power is removed to the unit.
3. Any button is pressed before the timer has expired. The detector will alert you with an audible and visual warning before it shuts off.

During this warning you can reset the timer by pressing any button. If the unit has automatically turned itself off, press the Power button to turn the unit back on.

Refer to "Option Select Mode" for instructions for changing the battery saver mode option.

Teach/Tutorial Mode

Provides simulated alerts for each type of signal.

- Press City and Quiet simultaneously and release.

Display shows:

TEACH

- Press Dark to cancel.

15

OPERATION

X/K Filter Modes

Recently, many new products operate on X or K band causing nuisance alerts to radar detectors. Some of these are radar based Traffic Monitoring Systems mounted to poles alongside the highway and others are K Band Lane Change Assistants and Blind Spot Detectors found on some automobiles. The X/K Filter Mode offers multiple levels of rejection to reduce false alerts caused by these systems.

Ka Filter Modes

There are times when a radar detector in another vehicle, can emit a frequency which can cause your detector to falsely alert. The Ka Filter Modes allow you to select the level needed for your area to minimize the occurrences of these false alerts.

Filter Mode is the factory default setting and should provide adequate filtering for most conditions. If you experience excessive alerts due to radar detectors in other vehicles, increase the Filter level. See Option Selection Mode to change the filter settings.

Setting Saver

Setting Saver saves your personalized settings so that when the detector is turned off and then on again, you do not have to re-enter them.

16

OPERATION

Ka Narrow Mode

Many countries do not share the same Ka radar guns as the USA. Having a radar detector that scans the complete Ka band may not be necessary if your Country is only using one or more of the following (34.0 or 34.3 GHz). See Option Select Mode to engage Ka Narrow mode.

17

OPERATION

Laser Signature ID (LSID)

Identify the Laser gun's pulse rate or PPS (Pulses per Second) that is transmitted by the speed laser gun. LSID may also be used to identify other forms of laser sources such as LACC (Laser Assisted Cruise Control) systems found in some high end vehicles. If the Laser PPS information displayed is due to another source such as local airports or LACC, LSID allows you to Lock Out this rate from giving you the continuous audio alert during this and any new encounter of the same rate.

To lock out a PPS, press the Quiet button during the Laser alert. This will place an * on the screen beside the PPS rate and Lock Out this signature ID. Any new encounter with the same Laser Signature ID will provide the display information and two quick beeps.

Caution: Do not lock out a PPS rate if it is close to known speed laser guns.

Adjustable Laser Receiver

If these alerts are bothersome, you may wish to turn on the LSID feature and make note of the PPS rate for these occurrences.

The laser validation windows are separated into 4 groupings allowing for customization to eliminate and/or make less frequent the number of laser alerts from these non police sources such as airports, laser assisted cruise control systems and more.

18

OPERATION

Adjustable Laser Receiver - continued

An example of this may be to shorten the first window from .05-1.0 to .05-.90, the second window can be adjusted from 1.0-2.0 to 1.2-2.0. You now have ignored any laser that has an average PPS rate between 900Hz and 1200Hz. Validation will occur from 50Hz to 900Hz, and resume from 1200Hz to 2000Hz.



If laser within a group is not used in your country, you may shut off that group (change the selection from Y to N while in Option Select Mode) by pressing the PWR and DARK button at the same time then releasing.

POP™ Mode Alerts

Because POP™ Mode radar utilizes the same K or Ka band frequencies, POP™ Mode Alerts will initially be displayed as POP K or POP Ka then switch to band and signal strength.

19

OPERATION

Safety Warning System™ SWS

In communities where transmitters are located, the Safety Warning System™ can transmit over 60 messages. When an SWS signal is detected the audio alert is Geiger counter-like. Safety Warning System Text Message
Example: Highway Advisory.

Note: Not all areas have Safety Warning System™ transmitters.

Alert Priority

When two or more signals are received at the same time, the alert priority is:

1. Laser
2. Speed Radar
3. Safety Radar

Example: If X band is alerting, then suddenly a laser signal is detected, the laser warning will override the X band alert.

Option Select Mode

Press the Menu button to enter Option Select Mode. Press the Menu button again will step thru in an ascending order while pressing the City button will step thru in a decending order.

OPERATION

Option Select Mode - continued

Press Quiet:	Display Shows:	To Change: D=Dark/Q=Quiet	To Reset or Accept Groups:	Options:
1st Time	TONE 3	D or Q	N/A	Tone 1, 2, 3 (Three Different Tone Patterns)
2nd Time	Test Yes	D=Yes Q=Off	N/A	Yes - X, K, Ka Laser Audio Tones OFF - One Beep during Power Up
3rd Time	X - ON	D=ON Q=OFF	N/A	X Band ON, OFF
4rd Time	K - ON	D=ON P=OFF	N/A	K Band ON, OFF
5th Time	Ka- NORM	D or Q	N/A	Norm, Off, Narrow
6th Time	LSR LSID	D or Q	N/A	LASER (NORM, OFF, LSID)
7th Time	.05 - 1.0 Y	D or Q	Press both D&Q	D= Left Group Adj, Q= Right Group Adj Change Laser Detection Area
8th Time	1.0 - 2.0 Y	D or Q	Press both D&Q	D= Left Group Adj, Q= Right Group Adj Change Laser Detection Area
9th Time	2.0 - 3.0 Y	D or Q	Press both D&Q	D= Left Group Adj, Q= Right Group Adj Change Laser Detection Area
10th Time	3.0 - 4.0 Y	D or Q	Press both D&Q	D= Left Group Adj, Q= Right Group Adj Change Laser Detection Area
11th Time	LSR XRY	D=ON Q=OFF	N/A	Traffpatrol ON, OFF
12th Time	SWS OFF	D=ON Q=OFF	N/A	SWS ON or OFF
13th Time	POP OFF	D = ON Q = OFF	N/A	POP Mode On POP Mode Off
14th Time	B SVR OFF	D = ON Q = OFF	N/A	Battery Saver On Battery Saver Off
15th Time	XK FLTR	D or Q	N/A	Filter 1, Filter 2, Filter 3, Filter 4
16th Time	Ka FLTR	D or Q	N/A	Filter 1, Filter 2, Filter 3
17th Time	LED BLNK	D or Q	N/A	Dual LED Alert Periscope On (ON, OFF, or Blinking)
18th Time	VG2 OFF	D or Q	N/A	VG-2 Mode On VG-2 Mode Off

Press the Power button to exit. Option mode will automatically exit if no buttons are pressed within 20 seconds.

OPERATION

Stay Alert Feature

The Stay Alert Feature is designed to test a driver's alertness.

To engage (when the unit is not alarming):

- Press and hold the City button for approximately 2 seconds. Release the button during or immediately after the alert is given.

Display shows:

RU ALERT

Within 30-60 seconds, two beeps are sounded; to show alertness, the driver must press either the City, Menu, or Quiet buttons within 3-5 seconds. If a button is pressed within 3-5 seconds, the cycle is repeated. Before unit alerts, press PWR to exit this feature. If a button is not pressed within 3-5 seconds, an alarm sounds and the display shows:

GET REST

- Press the DARK button to exit during the Get Rest message.

WARNING!!! Stay Alert is NOT intended as a substitute for adequate rest. You should NOT operate a vehicle if you are drowsy. During extended periods of vehicle operation, you should take frequent breaks. Improper reliance on the Stay Alert feature may result in vehicle damage, personal injury or death. **NEVER OPERATE A VEHICLE IF YOU ARE DROWSY.**

22

RADAR/LASER ALERTS

LASER/RADAR ALERTS

Speed Radar Audio/Visual Alerts when X, K or Ka is detected, the band ID and signal strength are displayed. The audio alert is continuous and has a Geiger counter-like pattern. The faster the beep, the closer or stronger the radar source.

Laser Audio/Visual Alerts

When a laser signal is detected the word "Laser" and bar graph is displayed, the audio alert is continuous for a minimum of 3 seconds.

Example:

LASER

Pulse Protection®

Pulse (or instant-on) radar is more of a threat than conventional radar because it remains "off" until activated to measure the speed of a targeted vehicle. When a pulse type transmission is detected, your Whistler detector sounds an urgent 3-second audio warning and the display shows:

PULSE

After the 3-second pulse alert, the standard alert pattern continues for as long as the signal is present. It is important to respond promptly to a pulse alert, since warning time may be minimal.

23

RESET FEATURES

Reset Features

All user features can be reset to factory settings.

- Remove Power from the unit.
- Press and hold the Quiet button.
- Restore Power to the unit. (power switch turned on)
- Wait for 2 beeps.
- Release the Quiet button.

Unit is now reset to the following features and settings.

1. City/Highway to Highway Mode.
2. Dim/Dark to full illumination of display.
3. Auto Quiet OFF.
4. SWS OFF.
5. Vehicle Battery Saver OFF
6. Full Power Up sequence.
7. Default TONE 3.
8. All Bands ON.
9. Laser LSID.
10. POP OFF.
11. LED Periscopes to BLNK.
12. X/K Filter 1.
13. Ka Filter 1.
14. All laser windows ON.
15. Laser TraffiPatrol XR ON.
16. VG-2 Mode OFF.

24

TROUBLESHOOTING

Care and Maintenance

Do not spray water, cleaners or polishes directly onto the unit. The spray may penetrate through the openings and damage the unit. Also, do not use any abrasive cleaners on the unit's exterior.

TROUBLESHOOTING

Your Whistler detector is expertly engineered and designed to exacting quality standards to provide you with reliable, trouble-free operation. If your unit has been correctly installed following the guidelines in this manual, but is not operating optimally, please refer to the troubleshooting guide below.

PROBLEM: No display or audio.

- Check fuse in power cable, replace if necessary.
- Check lighter socket fuse in vehicle's fuse box , replace if necessary.

PROBLEM: Unit alarms when vehicle equipment or electrical accessories (brakes, power mirrors/windows, directionals, horn, etc.)

- Check conditions of vehicle's electrical system, including battery and alternator.

PROBLEM: Audio alerts are not loud enough.

- Cancel Auto Quiet Mode or City Mode.
- Check audio level setting.

25

TROUBLESHOOTING

PROBLEM: Unit alarms when vehicle hits bumps.

- Check for loose lighter socket; tighten and clean.
- Check connections at both ends of the power cord. Substitute another cord to determine if the cord is defective. Return defective cord to the factory.

PROBLEM: Unit falses too much.

- If your country only uses 34.0 or 34.3 GHz use Ka Narrow Mode.
- If your country uses all of Ka band, switch to Ka Norm.
- If alarms are POP Ka, switch POP Mode to off.
- If the above option doesn't help, use a higher Ka Filter setting.
- If alarms are X or K band and due to radar based traffic flow sensors or radar based vehicle blind spot detectors, use a higher X/K Filter setting.

If difficulties occur which cannot be solved by information in this Troubleshooting Guide, please call Whistler Customer Service at 1-479-273-6012 or visit our FAQ page at www.whistlergroup.com, before returning your unit for service.

SPEED MONITORING TECHNOLOGIES

ARE DETECTORS LEGAL?

Check with your country's laws regarding radar detector ownership and use.

It is the responsibility of the individual radar detector user to know and understand the laws in your area regarding the legality of the use of radar detectors.

POPT™ Mode

POPT™ Mode is a feature on some radar guns operating on K and Ka bands. When the gun is in POPT™ Mode and activated, a brief burst of energy, less than 1/15 of a second, is transmitted and the vehicle's speed is quickly acquired. A detector without POPT™ Mode detection capability cannot respond to this brief transmission.

Laser Facts

It's well documented that many radar guns cannot reliably provide the speed of a targeted vehicle that is traveling in a group of vehicles. In contrast, a laser gun can target a specific vehicle out of a line of traffic and determine its speed. The advantage of laser over radar in terms of target identification is the result of the laser gun's narrow beam. A radar gun's transmission can cover more than a four-lane highway at a distance of 1,000 feet, compared with a laser gun's transmission which covers about 3 feet at the same distance.

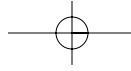

SPEED MONITORING TECHNOLOGIES

For best protection, keep these points in mind:

- Because the vehicle's license plate or headlights are the laser gun's primary targets, mounting the Whistler detector on the dashboard can improve laser detection at short range.
- Do not follow closely behind any vehicle you cannot see through. If you can't see past a vehicle ahead of you, chances are your detector can't either.
- The receiving range of your laser detector will not be the same as a radar detector. Laser guns are most often used at short range. Whistler Laser-Radar detectors receive all current laser guns which operate at a laser wavelength of 800-1000nm.

Laser Tips

If you are the targeted vehicle, a laser gun can often determine your speed within a few seconds after you receive an alert. In this situation, there is generally no time to safely adjust your speed. However, if you are traveling near or behind the targeted vehicle and receive an alert, response time should be sufficient. Any laser alert, regardless of duration, requires immediate action.

Radar Facts

A radar gun operates by transmitting radio waves at certain frequencies which reflect off objects and are picked up by the radar gun's receiving section. When a radar beam reflects off a moving target, a measurable frequency shift occurs. The radar unit converts this shift into miles per hour to determine your vehicle's speed.

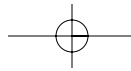

SPEED MONITORING TECHNOLOGIES

Radar Facts - Continued

This laser/radar detector receives signals from traffic radar guns at X Band (10.500 - 10.550 GHz), K Band (24.050 - 24.250 GHz), and Ka Band (33.400 - 36.000 GHz).

Note: Your radar detector is designed to alarm if an officer is transmitting on any one of the above radar bands.

Other Speed Detection Systems

Several techniques other than radar or laser are used to measure vehicle speeds. When these methods are being used, no detector can provide a warning.

These techniques include:

- Pacing - A patrol car drives behind you and matches your driving speed.
- Vascar/Aircraft - The police measure the time it takes your vehicle to travel a known distance.

Radar Detector Detectors: VG-2, Spectre

The Interceptor VG-2 or simply VG-2, is one type of microwave receiver used by Police to detect signals radiated by the local oscillator of a radar detector. Because its purpose is to identify persons driving with radar detectors, these devices are known as a "radar detector detector" (RDD). An RDD is the primary tool used by the police to identify radar detector equipped vehicles. If caught in a country where detectors are illegal, drivers risk losing their radar detector and receiving a fine. In addition, instant-on radar is almost always used in combination with an RDD, leaving unsuspecting motorists

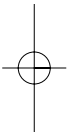

SPEED MONITORING TECHNOLOGIES

Radar Detector Detectors: VG-2, Spectre - Continued

vulnerable to receive two tickets; one potential for speeding, and the other for possession of a detector.

Note: The latest tool Police have to detect radar detectors is called Spectre. Spectre can detect the majority of undetectable (VG-2) laser/radar detectors on the market.

It is the responsibility of the individual radar detector user to know and understand the laws in your area regarding the legality of the use of radar detectors.

FCC INFORMATION

FCC ID: HSXWH10, HSXWH20 This device complies with part 15 of the FCC Rules. Operation is subject to the following two conditions: (1) This device may not cause harmful interference, (2) this device must accept any interference received, including interference that may cause undesired operation.

Important: FCC requirements state that changes or modifications not expressly approved by Whistler could void the user's authority to operate the equipment.

WARRANTY INFORMATION

Consumer Warranty

This Whistler Laser-Radar detector is warranted to the original purchaser for a period of three years from the date of original purchase against all defects in materials and workmanship. This limited warranty is void if the unit is abused, modified, installed improperly, or if the housing and/or serial numbers have been removed. There are no express warranties covering this product other than those set forth in this warranty. All express or implied warranties for this product are limited to the above time. Whistler is not liable for damages arising from the use, misuse, or operation of this product. **Note:** This warranty does not include installation or reinstallation charges.

Service Under Warranty

During the warranty period, defective units will be repaired without charge to the purchaser when returned with a dated store receipt to the address below. Units returned without a dated store receipt will be handled as described in section "Service Out of Warranty."

Due to the specialized equipment necessary for testing a Laser-Radar receiver, there are no authorized service stations for Whistler brand detectors other than Whistler.

When returning a unit for service, please follow these instructions:

1. Ship the unit in the original carton or in a suitable sturdy equivalent, fully insured, with return receipt requested to:

Whistler Repair Dept.
551 N. 13th St.
Rogers, AR. 72756

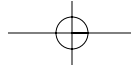

WARRANTY INFORMATION

Please allow 3 weeks turnaround time. **Important:** Whistler will not assume responsibility for loss or damage incurred in shipping. Therefore, please ship your unit insured with return receipt requested. CODs will not be accepted!

2. Include with your unit the following clearly printed information:

- Your name and street address (for shipping via USPS), a daytime telephone number and an email address, if applicable.
- A detailed description of the problem (e.g., "Unit performs self-test but does not respond to radar").
- A copy of your dated store receipt or bill of sale.

3. Be certain your unit is returned with its serial number. For reference, please write your unit's serial number in the following space:

s/n _____

Units without serial numbers are not covered under warranty.

IMPORTANT: To validate that your unit is within the warranty period, make sure you keep a copy of your dated store receipt. You may register your warranty online at www.whistlergroup.com, however, for warranty verification purposes, a copy of your dated store receipt must accompany any unit sent in for warranty work.

32

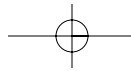

WARRANTY

Service Out of Warranty

Units will be repaired at "out of warranty" service rates when:

- The unit's original warranty has expired.
- A dated store receipt is not supplied.
- The unit has been returned without its serial number.
- The unit has been abused, modified, installed improperly, or had its housing removed.

The minimum out of warranty service fee for your Whistler detector is \$65.00 (U.S. Funds). If you require out of warranty service, please return your unit as outlined in the section "Service Under Warranty" along with a certified check or money order for \$65.00. Payment may also be made by MasterCard, VISA, or American Express; personal checks are not accepted. In the event repairs cannot be covered by the minimum \$65.00 service fee, you will be contacted by a Whistler technical service specialist who will outline options available to you. If you elect not to have your unit repaired, it will be returned to you along with your certified check or money order.

Important: When returning your unit for service, be certain to include a daytime telephone number and an email address (if applicable).

33

WARRANTY/SPECIFICATIONS

Customer Service

Representatives are available to answer your questions Monday - Friday from 8:00 a.m. to 5:00 p.m. (CT - USA) at:

1-479-273-6012

via email at: info@whistlergroup.com or visit the FAQ's at www.whistlergroup.com.

SPECIFICATIONS

Radar Frequencies:

10.500 - 10.550 GHz (X Band)
 24.050 - 24.250 GHz (K Band)
 33.400 - 36.000 GHz (Ka Superwideband)
 34.000 and 34.300 GHz (Ka Narrow)

Laser Wavelength: 800-1000 Nanometers (nm)

Operating Temperature Range:

-10 C to +70 C (+14 F to +158 F)

Power Requirements:

Operational 12 to 15 volts DC, 250mA nominal (2 amp fuse) Vehicle Battery Saver, 30mA nominal.

One or more U.S. patents may apply: #5,666,120 #7,215,276. Other patents pending.

 POP™ Mode is a trademark of MPH Industries, Inc.
 SWS™ is a trademark of Safety Warning System L.C.



Specifications are subject to change without notice.

ACCESSORIES

The following accessories can be ordered from Whistler by calling 1-479-273-6012.

Order #	Description	Price
202151	Windshield Bracket Kit	\$ 9.95
206552	Straight Power Cord (5')	\$14.95
206880	Hardwire Kit (10') (for wiring to fuse box)	\$ 9.95
206666	Modular Cord Package (includes coiled and straight cords, and power adapter)	\$17.95
159032	Package of 8 Suction Cups	\$ 2.95
402080	Non Skid Dash Pad	\$ 6.95

Plus Shipping and handling (per order).

Prices are subject to change without notice.