



PHONES

(044) 360-7-130
 (050) 336-0-130
 (063) 788-0-130
 (067) 233-0-130
 (068) 282-0-130

130 Internet store of autogoods

COM.UA



ICQ
 294-0-130
 597-0-130

SKYPE
 km-130

CAR RECEIVERS — Receivers • Media receivers and stations • Native receivers • CD/DVD changers • FM-modulators/USB adapters • Flash memory • Facia plates and adapters • Antennas • Accessories |
 CAR AUDIO — Car audio speakers • Amplifiers • Subwoofers • Processors • Crossovers • Headphones • Accessories | TRIP COMPUTERS — Universal computers • Model computers • Accessories |
 GPS NAVIGATORS — Portable GPS • Built-in GPS • GPS modules • GPS trackers • Antennas for GPS navigators • Accessories | VIDEO — DVR • TV sets and monitors • Car TV tuners • Cameras • Videomodules
 • Transcoders • Car TV antennas • Accessories | SECURITY SYSTEMS — Car alarms • Bike alarms • Mechanical blockers • Immobilizers • Sensors • Accessories | OPTIC AND LIGHT — Xenon • Bixenon • Lamps
 • LED • Stroboscopes • Optic and Headlights • Washers • Light, rain sensors • Accessories | PARKTRONICS AND MIRRORS — Rear parktronic • Front parktronic • Combined parktronic • Rear-view mirrors
 • Accessories | HEATING AND COOLING — Seat heaters • Mirrors heaters • Screen-wipers heaters • Engine heaters • Auto-refrigerators • Air conditioning units • Accessories | TUNING — Vibro-isolation
 • Noise-isolation • Tint films • Accessories | ACCESSORIES — Radar-detectors • Handsfree, Bluetooth • Windowlifters • Compressors • Beeps, loudspeakers • Measuring instruments • Cleaners • Carsits
 • Miscellaneous | MOUNTING — Installation kits • Upholstery • Grilles • Tubes • Cable and wire • Tools • Miscellaneous | POWER — Batteries • Converters • Start-charging equipment • Capacitors
 • Accessories | MARINE AUDIO AND ELECTRONICS — Marine receivers • Marine audio speakers • Marine subwoofers • Marine amplifiers • Accessories | CAR CARE PRODUCTS — Additives • Washer fluid •
 Care accessories • Car polish • Flavors • Adhesives and sealants | LIQUID AND OIL — Motor oil • Transmission oil • Brake fluid • Antifreeze • Technical lubricant



In store "130" you can find and buy almost all necessary goods for your auto in Kyiv and other cities, delivery by ground and postal services. Our experienced consultants will provide you with exhaustive information and help you to chose the very particular thing. We are waiting for you at the address

<http://130.com.ua>

ALPINE®

Digital Media Receiver

iDA-X305S



iPhone 3GS
16GB 32GB



iPhone 3G
8GB 16GB



iPhone
4GB 8GB 16GB



iPod touch
2nd generation
8GB 16GB 32GB 64GB



iPod touch
1st generation
8GB 16GB 32GB



- OWNER'S MANUAL
Please read before using this equipment.
- MODE D'EMPLOI
Veuillez lire avant d'utiliser cet appareil.
- MANUAL DE OPERACIÓN
Léalo antes de utilizar este equipo.

ALPINE ELECTRONICS MARKETING, INC.
1-1-8 Nishi Gotanda,
Shinagawa-ku,
Tokyo 141-0031, Japan
Phone 03-5496-8231

ALPINE ELECTRONICS OF AMERICA, INC.
19145 Gramercy Place, Torrance,
California 90501, U.S.A.
Phone 1-800-ALPINE-1 (1-800-257-4631)

ALPINE ELECTRONICS OF CANADA, INC.
777 Supertest Road, Toronto,
Ontario M3J 2M9, Canada
Phone 1-800-ALPINE-1 (1-800-257-4631)

ALPINE ELECTRONICS OF AUSTRALIA PTY. LTD.
161-165 Princes Highway, Hallam
Victoria 3803, Australia
Phone 03-8787-1200

ALPINE ELECTRONICS GmbH
Wilhelm-Wagenfeld-Str. 1-3,
80807 München, Germany
Phone 089-32 42 640

ALPINE ELECTRONICS OF U.K. LTD.
Alpine House
Fletchamstead Highway, Coventry CV4 9TW, U.K.
Phone 0870-33 33 763

ALPINE ELECTRONICS FRANCE S.A.R.L.
(RCS PONTOISE B 338 101 280)
98, Rue de la Belle Etoile, Z.I. Paris Nord II,
B.P. 50016, 95945 Roissy Charles de Gaulle
Cedex, France
Phone 01-48638989

ALPINE ITALIA S.p.A.
Viale C. Colombo 8, 20090 Trezzano
Sul Naviglio (MI), Italy
Phone 02-484781

ALPINE ELECTRONICS DE ESPAÑA, S.A.
Portal de Gamarra 36, Pabellón, 32
01013 Vitoria (Alava)-APDO 133, Spain
Phone 945-283588

ALPINE ELECTRONICS (BENELUX) GmbH
Leuvensesteenweg 510-B6,
1930 Zaventem, Belgium
Phone 02-725-13 15

Designed by ALPINE Japan
68-13530Z42-A

130.com.ua

Contents

Operating Instructions

WARNING

WARNING	4
CAUTION	4
PRECAUTIONS	4

Double Action Encoder Operation

Normal operation	6
Alternate operation	6

Getting Started

Accessory List	7
Turning Power On and Off	7
Detaching and Attaching the Front Panel	7
Initial System Start-Up	7
Adjusting Volume	7
Setting the Time and Calendar	7
Displaying the Calendar/Time	8

Radio

How to View the Display	8
Listening to Radio	9
Presetting Stations Manually	9
Presetting Stations Automatically	9
Tuning to Preset Stations	9
Receiving a Multicast Station (HD Radio mode only)	9
Changing the Display (HD Radio mode only)	10

iPod/iPhone

How to View the Display	11
Playback	11
Searching for a desired Song/Title	11
Page Skip Function/Percent Skip Function/ Alphabet Skip Function	12
Search Position Memory	12
Up/Down Function	12
Random Play Shuffle	13

Random Play Shuffle All	13
Repeat Play	13
Changing the Display	13

Pandora Radio (iPhone)

How to View the Display	14
Listening to Pandora	14
“Thumbs” Feedback	14
Searching for a Desired Station	15
Alphabet Search	15
Search by Date Added	15
QuickMix	15
Bookmarking a Desired Song or Artist	15
Changing the Display	15

USB memory/Portable audio player/ Changer

How to View the Display	16
Playback	17
Selecting a Disc (Changer) (Optional)	17
Multi-Changer Selection (Optional)	17
Select the desired Folder (Folder up/down) (MP3/WMA/AAC)	17
Repeat Play	18
M.I.X. (Random Play)	18
Searching for CD Track Number (CD changer only)	18
File/Folder Name Search (Concerning MP3/WMA/AAC)	19
USB memory mode	19
Portable audio player mode	19
MP3 Changer mode	19
About MP3/WMA/AAC	19

Sound Setting

Adjusting Subwoofer/Bass/Treble/Balance (Between Left and Right)/Fader (Between Front and Rear)/Loudness/Defeat	21
Setting the Bass Control	21
Setting the Bass Center Frequency	21
Setting the Bass Bandwidth	21
Setting the Treble Control	22
Adjusting the High Pass Filter	22
Turning Subwoofer ON/OFF	22

SETUP

BLUETOOTH Setting

Setting the BLUETOOTH Connection (BLUETOOTH IN)	23
--	----

General Setting

Setting the Clock Display (Clock Mode)	24
Setting of Calendar Display Pattern Switching (Calendar Type)	24
Setting Daylight Saving Time (Daylight Time)	24
Connecting an MP3 Changer (Play Mode)	24
Sound (Beep) Guide Function	24
Turning Mute Mode On/Off (Int Mute)	24
Setting Tone Defeat for External Devices (Int Audio)	24
Setting the Changer Name (CHG Name)	24
Setting the AUX Mode (V-Link)	24
Setting the AUX+ Mode	24
AUX+ Audio Level Adjustment (AUX+ IN GAIN)	24
Connecting to an External Amplifier (Power IC)	25
Setting the Language (Language)	25
Demonstration (Demo)	25

Display Setting

Changing Lighting Color (Illumination)	25
Dimmer Control (Dimmer)	25
Setting the Display Dimmer (Dimmer Level)	25
Scroll Setting (Text Scroll)	25
Switching the Display Type (BGV Select)	25
Setting the Wallpaper Color (BGV Color)	25
Downloading the Wallpaper (BGV Download)	26

iPod/iPhone Setting

iPod/iPhone Search Mode Setting	26
---------------------------------------	----

HD Radio™ Setting (Only when HD Radio Tuner is connected)

HD Radio Station Call Setting (Station Call)	26
Digital Seek On/Off Setting (Digital Seek)	26

Audio Setting

Storing the Audio Adjustment Level (User Preset)	26
Recalling the Audio Adjustment Level	26
Turning Media Xpander ON/OFF (MX)	27
Setting the MX Level (MX Level Adjustment)	27
Subwoofer On and Off (Subwoofer)	27
Setting the Subwoofer (Subwoofer System)	27

SAT Radio Receiver (Optional)

How to View the Display	27
-------------------------------	----

Receiving Channels with the SAT Radio Receiver (Optional)	28
Checking the SAT Radio ID Number	28
Storing Channel Presets	28
Receiving Stored Channels	28
Storing the desired Sports Team (SIRIUS only)	28
Storing while receiving a game broadcast ...	29
Game Alert Setup	29
Storing the desired Song/Artist (SIRIUS only)	29
Recalling the stored information (SIRIUS only)	29
Canceling the stored Alert Memory (SIRIUS only)	29
Search Function	30
Select the desired Category (Category up/down)	30
Receiving Weather or Traffic Information from SAT Radio	30
Instant Replay Function (SIRIUS only)	30
Changing the Display	31
Setting the Auxiliary Data Field Display	31

IMPRINT Operation (Optional)

Changing MultEQ mode	32
Adjusting Sound Setting in Manual Mode	32
Turning Media Xpander ON/OFF (MX)	33
Setting the MX Level	33
Equalizer Presets (Factory's EQ)	33
Turning Subwoofer ON/OFF	33
Setting the Subwoofer System	33
Setting the Subwoofer Phase	33
Setting the Subwoofer Channel	33
Setting the Response Slope for the High Range Speaker (Tweeter)	33
Setting EQ mode	33
Setting the Filter type	34
Setting the Time Correction Unit	34
Sound Field Adjustment	34
Adjusting the Parametric Equalizer Curve	34
Adjusting the Graphic Equalizer Curve	34
Adjusting the Time Correction	35
Adjusting the Crossover Settings	35
Storing and Recalling the Adjusted Contents	36
About Time Correction	37
About the Crossover	38

Information

In Case of Difficulty	39
Specifications	42

Installation and Connections

Warning	43
Caution	43
Precautions	43
Installation	44
Connections	46

LIMITED WARRANTY

130.com.ua

Operating Instructions

WARNING

WARNING

This symbol means important instructions. Failure to heed them can result in serious injury or death.

DO NOT OPERATE ANY FUNCTION THAT TAKES YOUR ATTENTION AWAY FROM SAFELY DRIVING YOUR VEHICLE.

Any function that requires your prolonged attention should only be performed after coming to a complete stop. Always stop the vehicle in a safe location before performing these functions. Failure to do so may result in an accident.

KEEP THE VOLUME AT A LEVEL WHERE YOU CAN STILL HEAR OUTSIDE NOISES WHILE DRIVING.

Excessive volume levels that obscure sounds such as emergency vehicle sirens or road warning signals (train crossings, etc.) can be dangerous and may result in an accident. LISTENING AT LOUD VOLUME LEVELS IN A CAR MAY ALSO CAUSE HEARING DAMAGE.

MINIMIZE DISPLAY VIEWING WHILE DRIVING.

Viewing the display may distract the driver from looking ahead of the vehicle and cause an accident.

DO NOT DISASSEMBLE OR ALTER.

Doing so may result in an accident, fire or electric shock.

USE ONLY IN CARS WITH A 12 VOLT NEGATIVE GROUND.

(Check with your dealer if you are not sure.) Failure to do so may result in fire, etc.

KEEP SMALL OBJECTS SUCH AS BOLTS OR SCREWS OUT OF THE REACH OF CHILDREN.

Swallowing them may result in serious injury. If swallowed, consult a physician immediately.

USE THE CORRECT AMPERE RATING WHEN REPLACING FUSES.

Failure to do so may result in fire or electric shock.

DO NOT BLOCK VENTS OR RADIATOR PANELS.

Doing so may cause heat to build up inside and may result in fire.

USE THIS PRODUCT FOR MOBILE 12V APPLICATIONS.

Use for other than its designed application may result in fire, electric shock or other injury.

CAUTION

This symbol means important instructions. Failure to heed them can result in injury or material property damage.

HALT USE IMMEDIATELY IF A PROBLEM APPEARS.

Failure to do so may cause personal injury or damage to the product. Return it to your authorized Alpine dealer or the nearest Alpine Service Center for repairing.

PRECAUTIONS

Product Cleaning

Use a soft dry cloth for periodic cleaning of the product. For more severe stains, please dampen the cloth with water only. Anything else has the chance of dissolving the paint or damaging the plastic.

Temperature

Be sure the temperature inside the vehicle is between +60°C (+140°F) and -10°C (+14°F) before turning your unit on.

Maintenance

If you have problems, do not attempt to repair the unit yourself. Return it to your Alpine dealer or the nearest Alpine Service Station for servicing.

Installation Location

Make sure the iDA-X305S will not be installed in a location subjected to:

- Direct sun and heat
- High humidity and water
- Excessive dust
- Excessive vibrations

Protecting the USB connector

- Only an iPod/iPhone, USB memory or Portable audio player can be connected to the USB connector on this unit. Correct performance using other USB products cannot be guaranteed.
- If the USB connector is used, be sure to use only the supplied connector cable with the unit. A USB hub is not supported.
- Depending on the connected USB memory device, the unit may not function or some functions may not be performed.
- The audio file format that can be played back on the unit is MP3/WMA/AAC.
- Artist/song name, etc., can be displayed, however characters may not be correctly displayed.

CAUTION

Alpine accepts no responsibility for lost data, etc., even if data, etc., is lost while using this product.

On Handling USB Memory

- This unit can control a memory storage device that supports the USB Mass Storage Class (MSC) protocol. Playable audio file formats are MP3, WMA and AAC.
 - USB memory function is not guaranteed. Use USB memory according to the terms of agreement. Read the USB memory Owner's Manual thoroughly.
 - Avoid usage or storage in the following locations:
 - Anywhere in the car exposed to direct sunlight or high temperatures.
 - Anywhere the possibility of high humidity or corrosive substances are present.
 - Fix the USB memory in a location where driver operation will not be hindered.
 - USB memory may not function correctly at high or low temperature.
 - Use only certified USB memory. Note that even certified USB memory, may not function correctly depending on its type or state.
 - Depending on the settings of the USB memory type, memory state or encoding software, the unit may not play back or display properly.
 - Files that are copy-protected (using some type of DRM, Digital Rights Management) cannot be played back on this unit. WMA format files with DRM or AAC format files that have been purchased from the iTunes Store are included in this restriction.
 - USB memory may take time to start playback. If there is a particular file other than audio in the USB memory, it may take considerable time before the file is played back or searched.
 - The unit can play back "mp3," "wma" or "m4a" file extensions.
 - Do not add the above extensions to a file other than audio data. This non-audio data will not be recognized. The resulting playback may contain noise that can damage speakers and/or amplifiers.
 - It is recommended to back up important data on a personal computer.
 - Do not remove the USB device while playback is in progress. Change SOURCE to something other than USB, then remove the USB device to prevent possible damage to its memory.
- If the Portable audio player has an MSC/MTP setting, set to MTP.
 - A Portable audio player in which data is stored by USB Mass Storage may not be playable on the unit.
 - Depending on the Portable audio player settings, USB Mass Storage may be supported. For setting, refer to the Owner's Manual of the player.
 - The unit can play back MP3/WMA files synchronized by Windows Media Player (Ver. 10 or 11), and are then forwarded to the player. The "mp3" or "wma" extensions are playable.
 - If data is not synchronized by Windows Media Player and is forwarded in another way, the unit may not be able to correctly play back the files.
 - WMDRM10 is supported by the unit.
 - A file that is copy-protected (copyright protection) cannot be played back.
 - It is recommended to back up important data on a personal computer.
 - Do not remove the USB device while playback is in progress. Change SOURCE to something other than USB, then remove the USB device to prevent possible damage to its memory.

On Handling Portable audio player

- The unit can control a Portable audio player with the USB interface. Playable audio file formats are MP3 and WMA.
- Portable audio player function is not guaranteed. Use Portable audio player according to the terms of agreement. Read the Portable audio player Owner's Manual thoroughly.
- Avoid usage or storage in the following locations:
 - Anywhere in the car exposed to direct sunlight or high temperatures.
 - Anywhere the possibility of high humidity or corrosive substances are present.
- Fix the Portable audio player in a location where driver operation will not be hindered.
- Portable audio player may not function correctly at high or low temperature.
- Depending on the settings of the Portable audio player type, memory state or encoding software, the unit may not play back or display properly.

Double Action Encoder Operation

Double Action encoder

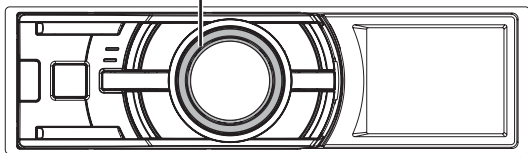

There are 2 ways to operate the Double Action encoder.

Normal operation

Rotate the **Double Action encoder** to the left or right.

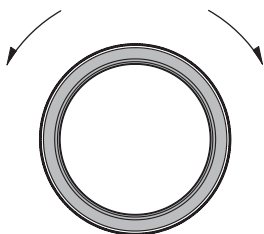

The adjust volume and scroll through a list of items.

Alternate operation

Press in the outer ring and rotate the **Double Action encoder** to the left or right.

When you release the Double Action encoder, the display changes.

Press the Double Action encoder.

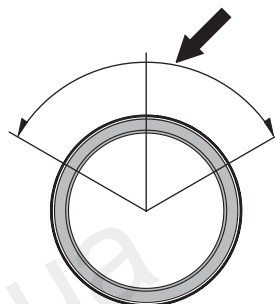
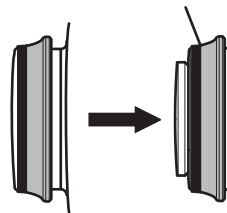

Depending on the current mode, the resultant action varies. If you press then rotate and hold the **Double Action encoder** to the left or right, the items/displays change continuously.

Getting Started

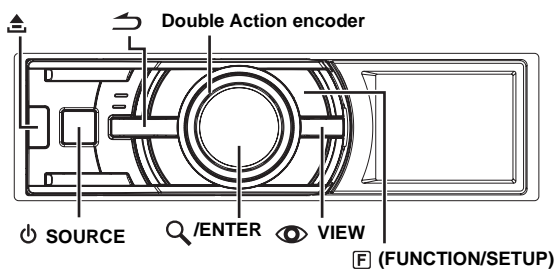

Accessory List

- Digital Media receiver.....1
- Power cable.....1
- Mounting sleeve.....1
- Carrying case.....1
- Front frame.....1
- Bracket key.....2
- Screw (M5x8).....4
- USB cable.....1
- iPod Dock interface cable.....1
- Owner's Manual.....1 set

Turning Power On and Off

Press **SOURCE** to turn on the unit.

- The unit can be turned on by pressing any other button except **(Release)**, **Double Action encoder** and **VIEW**. The unit is also automatically turned on if an iPod/iPhone or USB memory is connected.

Press and hold **SOURCE** for at least 2 seconds to turn off the unit.

Detaching and Attaching the Front Panel

Detaching

- 1 Turn off the unit power.
- 2 Press **(Release)** at the lower left side until the front panel pops out.
- 3 Grasp the left side of the front panel and pull it out.

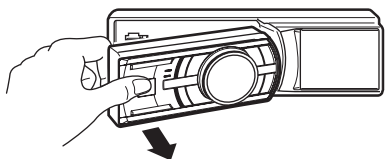

- The front panel may become hot in normal usage (especially the connector terminals on the back of the front panel.) This is not a malfunction.
- To protect the front panel, place it in the supplied carrying case.

Attaching

- 1 Insert the right side of the front panel into the main unit. Align the groove on the front panel with the projections on the main unit.
- 2 Push the left side of the front panel until it locks firmly into the main unit.

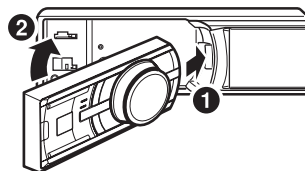

- Before attaching the front panel, make sure that there is no dirt or dust on the connector terminals and no foreign object between the front panel and the main unit.
- Attach the front panel carefully. Hold the panel by its sides to avoid pushing any buttons by mistake.

Initial System Start-Up

Be sure to press the RESET switch when using the unit for the first time, after changing the car battery, etc.

- 1 Turn off the unit power.
- 2 Press **(Release)** to remove the front panel.
- 3 Press **RESET** with a ballpoint pen or similar pointed object.



Adjusting Volume

Rotate the **Double Action encoder** until the desired sound is obtained.

Setting the Time and Calendar

- 1 Press and hold **F (FUNCTION/SETUP)** for at least 2 seconds to activate the SETUP selection mode.
- 2 Rotate the **Double Action encoder** to select "General", and then press **Q/ENTER**.

BLUETOOTH ↔ General ↔ Display ↔ iPod ↔ XM* ↔ SIRIUS* ↔ HD Radio* ↔ Audio

* Only when HD Radio Tuner/SAT Radio receiver is connected.

- 3 Rotate the **Double Action encoder** to select **Clock Adjust**, and then press **Q/ENTER**.
The calendar setting mode is activated.
When the year is set, proceed step 5.

- 4 Rotate the **Double Action encoder** to select year, month, day, hour or minutes to be set.
- 5 Press **Q/ENTER**.
The year setting mode is activated, and the year blinks. (When "year" is set)
- 6 Rotate the **Double Action encoder** to set year, and then press **Q/ENTER**.
The setting for year is complete. (When "year" is set)
- 7 Repeat steps 4 to 6 above to set month, day, hour and minutes.
- 8 Press and hold **↶** for at least 2 seconds to return to normal mode.

• Pressing **↶** during the procedure will return to the previous mode.

Displaying the Calendar/Time

Press **VIEW**.

The calendar/time is displayed. Pressing **VIEW** again will return to normal mode.



- Selecting any tuner or iPod/iPhone function while in the clock priority mode will interrupt the time display momentarily. The function selected will be displayed for about 5 seconds before the time returns to the display.
- If an HD Radio Tuner is connected, text information can be displayed. Refer to "Changing the Display (HD Radio mode only)" (page 10).
- If an XM receiver is connected, the Auxiliary Data Field can be displayed. Refer to "Setting the Auxiliary Data Field Display" (page 31).
- If an iPod/iPhone is connected, the album cover screen can be displayed. Refer to "Changing the Display" (page 13).
- In Auxiliary/Auxiliary+ mode, Calendar/Time is not displayed.

Controllable With Remote Control

Point the optional remote control transmitter at the remote control sensor.

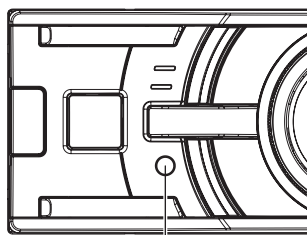

Remote control sensor

Radio

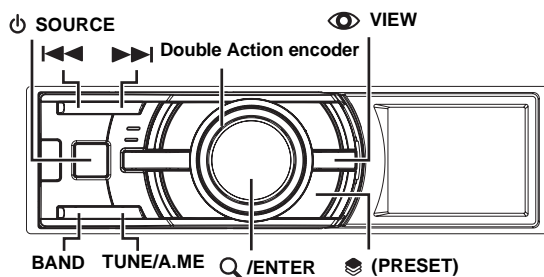

This unit cannot receive HD Radio™ signals (digital terrestrial radio). In order to activate the digital radio functions described below, an optional HD Radio Tuner module must be connected through the Ai-NET bus.

iTunes Tagging lets you tag songs you hear on HD Radio stations with your new iDA-X305S and then preview, buy, and download them later from your iTunes Tagged playlist the next time you sync your iPod. If the unit is connected to a Tagging compatible device, you can use the iTunes Tagging function. For details, refer to the Owner's Manual of the Tagging compatible device.

How to View the Display

<Radio screen display example>

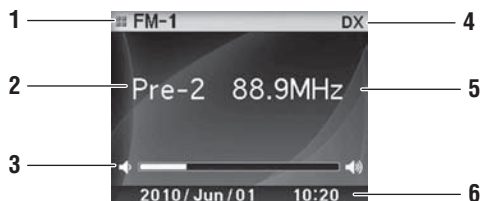

- 1 Mode display
- 2 Preset number
- 3 Volume
- 4 Tuning mode
- 5 Frequency
- 6 Calendar/Time

Listening to Radio

HD Radio™ broadcasting can be received if the HD Radio TUNER MODULE is connected. While receiving HD Radio signal, the unit can automatically switch between the analog and digital signal.

- 1 Press **SOURCE** to select **TUNER mode**.
- 2 Press **BAND** repeatedly until the desired radio band is displayed.

FM-1 → FM-2 → AM → FM-1

- 3 Press **TUNE/A.ME** to select the tuning mode.

DX (Distance mode) → Local (Local mode) → Manual (Manual mode) → DX (Distance mode)

- The initial mode is Distance mode.

Distance mode:

Both strong and weak stations will be automatically tuned in (Automatic Seek Tuning).

Local mode:

Only strong stations will be automatically tuned in (Automatic Seek Tuning).

Manual mode:

The frequency is manually tuned in steps (Manual tuning).

- 4 Press **◀◀** or **▶▶** to tune in the desired station.

Holding down **◀◀** or **▶▶** will change the frequency continuously.

- “Digital” appears in the display whenever an HD Radio station (containing both audio and text information) is received.
- If Digital Seek is set to ON, the SEEK UP/DOWN functions stops on HD Radio broadcasts only. Refer to “Digital Seek On/Off Setting (Digital Seek)” (page 26).

Presetting Stations Manually

- 1 Select the radio band and tune in a desired radio station you wish to store in the preset memory.
- 2 Press **(PRESET)**. The Preset screen is displayed.
- 3 Rotate the **Double Action encoder** to select the preset number.
- 4 Press and hold **Q/ENTER** for at least 2 seconds. The selected station is stored. The display shows the band, preset number and station frequency memorized.

- A total of 18 stations can be stored in the preset memory (6 stations for each band; FM1, FM2 and AM).
- If you store a station in a preset memory which already has a station, the current station will be cleared and replaced with the new station.
- Press in the outer ring and rotate the **Double Action encoder** to the left or right on the Preset screen, you can switch the Preset screen of another band.

FM-1 ↔ FM-2 ↔ AM ↔ FM-1

You can also change the desired radio band by pressing **BAND**.

Presetting Stations Automatically

- 1 Press **BAND** repeatedly until the desired radio band is displayed.
 - 2 Press and hold **TUNE/A.ME** for at least 2 seconds. “Auto Memory” is displayed while the automatic memory is in progress. The tuner will automatically seek and store 6 strong stations in the selected band. They will be stored 1 to 6 in order of signal strength. When the automatic memory has been completed, the tuner goes to the station stored in preset location No.1.
- If no stations are stored, the tuner will return to the original station you were listening to before the auto memory procedure began.

Tuning to Preset Stations

- 1 Press **BAND** repeatedly until the desired band is displayed.
 - 2 Press **(PRESET)**. The Preset screen is displayed.
 - 3 Rotate the **Double Action encoder** to select a radio station.
 - 4 Press **Q/ENTER**. The display shows the band, preset number and frequency of the station selected.
- Press in the outer ring and rotate the **Double Action encoder** to the left or right on the Preset screen, you can switch the Preset screen of another band.
- FM-1 ↔ FM-2 ↔ AM ↔ FM-1
You can also change the desired radio band by pressing **BAND**.

Receiving a Multicast Station (HD Radio mode only)

Multicasting is the ability to broadcast multiple program streams over a single FM frequency. This increases the amount and diversity of content choices. A maximum of eight multicast station channels can be selected on this unit.

- 1 When multicast station is received, the program number is displayed.

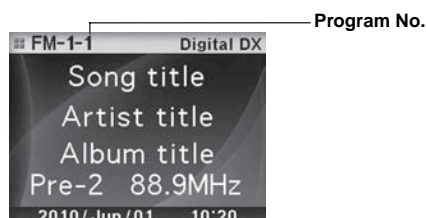

2 Press **Q/ENTER** to display the Program Type screen.



3 Rotate the **Double Action encoder** to select a program, and press **Q/ENTER**.

The selected program is received.

Program Service example:

Multicast Radio Station	Program No.	Program Service
88.9MHz	No.1	MPS: Main Program Service
88.9MHz	No.2	SPS: Supplemental Program Service
88.9MHz	No.3	SPS: Supplemental Program Service
	.	.
88.9MHz	No.8	SPS: Supplemental Program Service

Changing the Display (HD Radio mode only)

Press **VIEW**.

Every time **VIEW** is pressed changes the display.

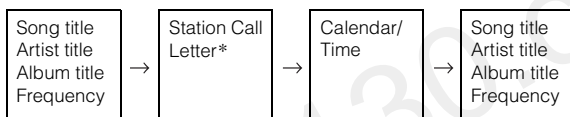

* You can set a long or short HD Radio station name. Refer to "HD Radio Station Call Setting (Station Call)" (page 26).

iPod/iPhone

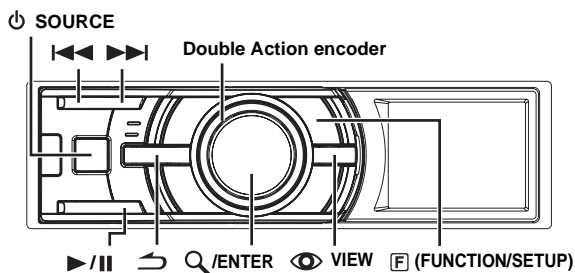

When an iPod/iPhone is connected to the iDA-X305S by using the proper cable, the controls on the iPod/iPhone are not functional.

- Internet or telephone functions, etc., of the iPhone or iPod touch are not controllable from the unit, but these functions can be controlled using the iPhone or iPod touch itself.
- If you connect an iPhone to the iDA-X305S, it can be used as an iPod. If you use iPhone as a hands-free phone, you need the optional **BLUETOOTH INTERFACE (KCE-400BT)**.
- This unit does not support the iPod **FULL SPEED** connection. Therefore, even if you connect an iPod/iPhone using the **FULL SPEED** connection cable (KCE-433iV) on the **BLUETOOTH INTERFACE (KCE-400BT)**, you cannot operate the iPod/iPhone.
- This unit does not support video playback from iPod/iPhone.

About iPod/iPhone usable with this unit

- Confirmed devices regarding Made for iPod. Correct function of earlier versions cannot be guaranteed.
 - iPod touch (Late 2009): Ver.3.1.2
 - iPod nano (5th generation): Ver.1.0.1
 - iPod classic (Late 2009): Ver.2.0.3
 - iPod touch (2nd generation): Ver.3.1.2
 - iPod nano (4th generation): Ver.1.0.3
 - iPod classic (120GB): Ver.2.0.1
 - iPod touch (1st generation): Ver.3.1.2
 - iPod nano (3rd generation): Ver.1.1.3
 - iPod classic (80GB, 160GB): Ver.1.1.2
 - iPod nano (2nd generation): Ver.1.1.3
 - iPod with video: Ver.1.3
 - iPod nano (1st generation): Ver.1.3.1
- Confirmed devices regarding Works with iPhone. Correct function of earlier versions cannot be guaranteed.
 - iPhone 3GS: Ver.3.1.2
 - iPhone 3G: Ver.3.1.2
 - iPhone: Ver.3.1.2
- For clarity in identifying your model of iPod, please see Apple's own document "Identifying iPod models" at <http://support.apple.com/kb/HT1353>.

How to View the Display

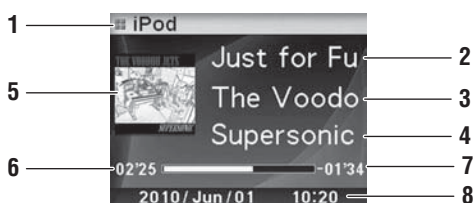

- 1 Mode display
 - 2 Song title/Episode title/Audiobook title
 - 3 Artist title/Podcast title
 - 4 Album title/Release date
 - 5 Artwork screen
 - 6 Elapsed time
 - 7 Remaining time for playing
 - 8 Calendar/Time
- When playback time reaches 100 minutes, “00’00” is displayed.

Playback

- 1 Press **⏻ SOURCE** to switch to the iPod mode.
 - 2 Press **⏮** or **⏭** to select the desired song.
 - Return to the beginning of the current song:**
Press **⏮**.
 - Fast backward:**
Press and hold **⏮**.
 - Advance to the beginning of the next song:**
Press **⏭**.
 - Fast forward:**
Press and hold **⏭**.
 - 3 To pause playback, press **⏸/||**.
Pressing **⏸/||** again will resume playback.
- If a song is playing on the iPod/iPhone when it is connected to the iDA-X305S, it will continue playing after the connection.
 - Podcasts or audiobooks may have several chapters. The chapters can be changed by pressing **⏮** or **⏭**.

Searching for a desired Song/Title

An iPod/iPhone can contain thousands of songs. The unit for this reason can make various searches using the search function as shown below.

Using the Playlist/Artist/Album/Podcast/Audiobook/Genre/Composer/Song search mode’s individual hierarchy, you can narrow down your search as shown in the table below.

Hierarchy 1	Hierarchy 2	Hierarchy 3	Hierarchy 4
Playlists	Songs	—	—
Artists	Albums	Songs	—
Albums	Songs	—	—
Podcasts	Episodes	—	—
Audiobooks	—	—	—
Genres	Artists	Albums	Songs
Composers	Albums	Songs	—
Songs	—	—	—

- You can select your preferred search mode. Refer to “iPod/iPhone Search Mode Setting” (page 26).
- For example, if the selected artist has only one album, the song search mode is selected immediately, skipping the album search mode.

For example: Searching by Artist name

The following example explains how an ARTIST search is performed. Another search mode can be used for the same operation, although the hierarchy differs.

- 1 Press **🔍/ENTER** to activate the Menu Select mode.
- 2 Rotate the **Double Action encoder** to select “Artists”, and then press **🔍/ENTER**.
The artist search mode is activated and an artist name is displayed.
- 3 Rotate the **Double Action encoder** to select the desired Artist, and then press **🔍/ENTER**.
The album search mode is activated and an album name is displayed.
Pressing and holding **🔍/ENTER** for at least 2 seconds will play back all songs of the selected artist.
- 4 Rotate the **Double Action encoder** to select an album, and then press **🔍/ENTER**.
The song search mode is activated and a song name is displayed.
Pressing and holding **🔍/ENTER** for at least 2 seconds will play back all songs of the selected album.
- 5 Rotate the **Double Action encoder** to select a song and press **🔍/ENTER**.
The selected song is played back.

- While in the search mode, if you press and hold **↶** for at least 2 seconds the search mode is canceled.
- In the search mode, pressing **↶** will return to the previous mode.
- If the name of iPod/iPhone is selected in the Playlist search mode and **Q/ENTER** is pressed, all songs in the iPod/iPhone are searchable. If you press and hold **Q/ENTER** for at least 2 seconds, all songs in the iPod/iPhone are played back beginning from the first song listed.
- "No Support" is displayed when text information is not compatible with the iDA-X305S.
- When a list is displayed, you can use the page skip, percent skip, or alphabet skip function. For details, refer to "Page Skip Function/Percent Skip Function/Alphabet Skip Function" (page 12).
- During the search mode, if you select All and press **Q/ENTER**, you can search for all titles in the next hierarchy. If you select All, and press and hold **Q/ENTER** for at least 2 seconds, all titles in the selected hierarchy are played back repeatedly.

Page Skip Function/Percent Skip Function/Alphabet Skip Function

The unit is provided with a page skip/percent skip/alphabet skip function for effective searching. When you use this function in the search mode, you can quickly search an artist or a song, etc.

1 Press **[F]** (FUNCTION/SETUP) repeatedly to choose the desired mode.

The factory setting is set to the page skip function.

Page skip function → Alphabets skip function → Percent skip function → Page skip function

- Page skip function: The list is skipped page by page.
- Alphabet skip function: The alphabet skip function is skipped to the next alphabet such as from A to B, B to C. You can skip in reverse order such as B to A by rotating the Double Action encoder to the left.
- Percent skip function: For example, 100 songs are stored in the iPod/iPhone. These 100 songs are divided into 10 groups (0%, 10%, ... 90%).

2 Press in the outer ring and rotate the Double Action encoder to the left or right.

A list is skipped to the next page, next alphabet or percent.

■ Percent skip display example



■ Alphabet skip display example



- If you press then rotate and hold the **Double Action encoder** to the left or right, the display continuously changes.
- The order of the list depends on the design of the iPod/iPhone.

Search Position Memory

During iPod/iPhone playback, you can quickly move back up the selected hierarchy, a level at a time.

Press **↶**.

The hierarchy level you selected last in the search mode is displayed. Repeated presses return to each previous level up to the highest.

Up/Down Function

If you select an album and press and hold **Q/ENTER** in the search mode, this album will be played back repeatedly. To go to the previous or next Album, use the Up/Down function.

■ Indicator display

The display of the UP/DOWN indicator shows which item can be selected.

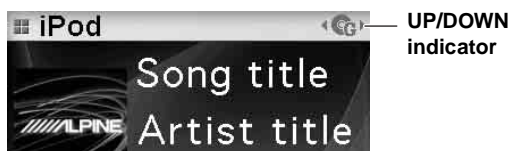

	Playlist
	Artist
	Album
	Podcast
	Audiobook
	Genre
	Composer

Press in the outer ring and rotate the Double Action encoder to the left.

Returns to the previous item.

Press in the outer ring and rotate the Double Action encoder to the right.

Advances to the next item.

- If you do not perform a search, this function is not valid.
- If you are searching for a song, this operation cannot be performed.
- During an artist search, albums for that artist can be played.
- If an album is selected during an artist search, the Up/Down function can be used to play other albums by that artist.

Random Play Shuffle

- 1 Press **F** (**FUNCTION/SETUP**).
The Function screen is displayed.
- 2 Rotate the **Double Action encoder** to select **"Shuffle"**, and press **Q/ENTER**.
The Shuffle mode is activated.
- 3 Rotate the **Double Action encoder** to select the **Shuffle playback mode**, and press **Q/ENTER**.

Shuffle Album  : An album in the iPod/iPhone is selected at random, and is played back in the album song order.

Song  : If you select a song in the search mode, all songs in the selected mode are played back at random.

Off : Shuffle mode off.

- 4 Press **→**.
The songs will be played back in random sequence.

- To cancel, select **Off** in the above procedure.
- *Shuffle Album/Shuffle Song works the same way as iPod/iPhone Shuffle Albums/Shuffle Songs.*

Random Play Shuffle All

Shuffle ALL plays all songs in the iPod/iPhone randomly.

- 1 Press **Q/ENTER**.
The Menu Select screen is displayed.
- 2 Press **Q/ENTER** while selecting **"Shuffle All"**.
The indicator  **ALL** lights, and the songs will be played back in random sequence.

- To cancel, set the Shuffle mode to Off. Refer to "Random Play Shuffle" (page 13).
- If Shuffle All is selected, the selected ones which are being played back in the search mode are cancelled.

Repeat Play

- 1 Press **F** (**FUNCTION/SETUP**).
The Function screen is displayed.
- 2 Press **Q/ENTER**.
The Repeat mode is activated.
- 3 Rotate the **Double Action encoder** to select **"Song"**, and press **Q/ENTER**.

Repeat Song  : A single song is repeatedly played back.

Off : Repeat mode off.

- 4 Press **→**.
The song is repeatedly played back.

- To cancel, select **Off** in the above procedure.
- During repeat playback, no other songs are selectable by pressing **◀** or **▶**.
- Both the shuffle and repeat indicators that can be set are displayed, only one song repeats.

Changing the Display

Press  **VIEW**.

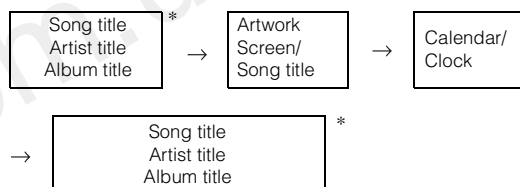

* TAG information
If there is no text information, nothing will be displayed.

- Only alphanumeric characters can be displayed.
- The maximum number of characters is 128 (128 byte).
- Some characters may not be correctly displayed.
- "No Support" is displayed when text information is not compatible with the iDA-X305S.

Pandora Radio (iPhone)

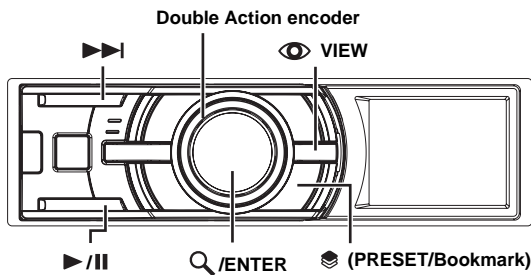

Pandora Radio is your own FREE personalized radio now available to stream music on your iPhone.

Just start with the name of one of your favorite artists, songs or classical composers and Pandora will create a "station" that plays their music and more music like it.

The iDA-X305S enables you to interact with your Pandora account, by connecting an iPhone that has the Pandora Compatible Application for iPhone already installed.

For details on the Pandora Compatible Application for iPhone, visit: <http://www.pandora.com/on-the-iphone>

To control Pandora through this iDA-X305S, you must be running a version of Pandora's mobile application that supports Pandora link, on a compatible smartphone. For information on compatible phones and applications, visit www.pandora.com/link.

- Some of the Pandora Compatible Application for iPhone functions are not controllable from the iDA-X305S.

How to View the Display

<Pandora screen display example>

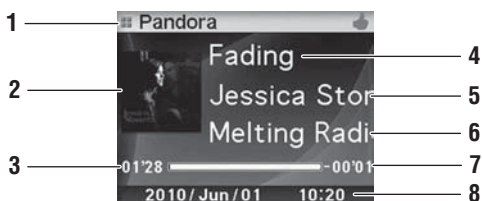

- 1 Mode display
- 2 Album Artwork display
- 3 Elapsed time
- 4 Song title
- 5 Artist title
- 6 Album title/Station title
- 7 Remaining song play time
- 8 Calendar/Time

Listening to Pandora

- 1 **Launch the Pandora App on the iPhone.**
The iDA-X305S switches to Pandora mode.
 - 2 **To pause playback, press ▶/II.**
Pressing ▶/II again will resume playback.
 - 3 **To skip to the next song, press ▶▶I.**
 - 4 **Quit the Pandora App on the iPhone to exit Pandora mode on the iDA-X305S.**
The iDA-X305S switches to the iPod mode.
- While Pandora is running, the iDA-X305S can return to the Pandora mode from any other source.
 - The operation to replay a previous song is not available.
 - Pandora limits the number of skips allowed on their service. If you attempt to skip songs beyond the limit, "No Skips Remaining" is displayed.

"Thumbs" Feedback

You can personalize your stations with "Thumbs Up" or "Thumbs Down" feedback, which the system takes into account for future music selections.

During playback, press in the outer ring and rotate the Double Action encoder to the left for thumbs down, or right for thumbs up.

- Right: The "👍" indicator appears in the display. Pandora will add similar music to your station.
- Left: The "👎" indicator is displayed. Pandora will ban that song from your station, and the current song is skipped. If the number of skips allowed has reached its limit, the current song continues to play back.

- In some situations, "Thumbs" feedback may not be available.

Searching for a Desired Station

You can display your station list and select stations directly from the iDA-X305S.

Alphabet Search

- 1 Press **Q/ENTER** to activate the Search mode.
- 2 Rotate the **Double Action encoder** to select “A-Z”, and then press **Q/ENTER**.
The “A-Z” search mode is activated and the station names are listed alphabetically.
- 3 Rotate the **Double Action encoder** to select the desired station, and then press **Q/ENTER**.
Pandora will play that station.

Search by Date Added

- 1 Press **Q/ENTER** to activate the Search mode.
- 2 Rotate the **Double Action encoder** to select “By Date”, and then press **Q/ENTER**.
The “By Date” search mode is activated and the station names are listed by the date they were added to the account.
- 3 Rotate the **Double Action encoder** to select the desired station, and then press **Q/ENTER**.
Pandora will play that station.

- *Creating a New Station*
When you are not driving and when the iPhone is not connected to the iDA-X305S, you can create personalized Pandora stations using the Pandora App on your iPhone. You can also create stations on the web at www.pandora.com.

QuickMix

Use QuickMix to create a playlist based on two or more of your Pandora stations. Edit your QuickMix station selections on the Pandora Compatible Application for iPhone when it is not connected to the iDA-X305S.

- 1 Press **Q/ENTER** to activate the Search mode.
- 2 Rotate the **Double Action encoder** to select “A-Z” or “By Date,” and then press **Q/ENTER**.
The “A-Z” or “By Date” search mode is activated and the station name is displayed.
- 3 Press **Q/ENTER** while selecting “QuickMix.”
• The **⌘** indicator lights, and the songs from the created stations are played back in random sequence.

Bookmarking a Desired Song or Artist

The currently playing song or artist can be bookmarked and saved to your Pandora account.

- 1 During playback, press **Ⓢ (PRESET/Bookmark)**.
The Pandora Bookmark screen is displayed.
 - 2 Rotate the **Double Action encoder** to select “Song Bookmark” or “Artist Bookmark”, and then press **Q/ENTER**.
The current song or artist is bookmarked. “Song Bookmarked” or “Artist Bookmarked” is displayed.
- Your bookmarks can be viewed on your “Profile” page at www.pandora.com.
 - In some situations, bookmarks may not be available.

Changing the Display

Press **Ⓢ VIEW**.



- * TAG information
If there is no text information, nothing will be displayed.
- Only alphanumeric characters can be displayed.
- The maximum number of characters is 128 (128 byte).
- Some characters may not be correctly displayed.
- “No Support” is displayed when text information is not compatible with the iDA-X305S.

USB memory/ Portable audio player/Changer

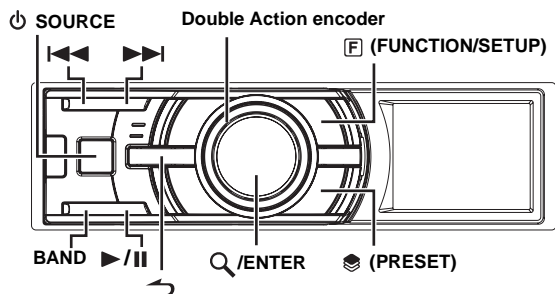

If a USB memory device, Portable audio player or changer is connected to the unit, MP3/WMA/AAC files can be played back.

How to View the Display

USB memory/Portable audio player display

USB memory/Portable audio player screen display example (if tag information exists)

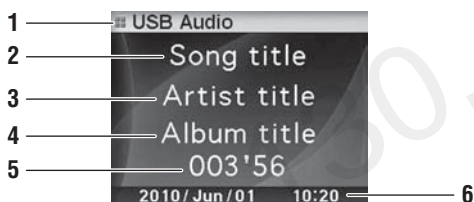

- 1 Mode display
- 2 Song title
- 3 Artist title
- 4 Album title
- 5 Elapsed time
- 6 Calendar/Time

USB memory/Portable audio player screen display example (if no tag information exists)



- 1 Mode display
- 2 Folder name*
- 3 File name
- 4 Elapsed time
- 5 Calendar/Time

Changer display

<Changer CD screen display example (if CD text exists)>



- 1 Mode display
- 2 CD text (disc name)*2
- 3 CD text (track name)*2
- 4 Disc number
- 5 Track number
- 6 Elapsed time
- 7 Calendar/Time

<Changer CD screen display example (if no CD text exists)>



- 1 Mode display
- 2 Disc number
- 3 Track number
- 4 Elapsed time
- 5 Volume
- 6 Calendar/Time

<Changer MP3 screen display example (if tag information exists)>



- 1 Mode display
- 2 Song title
- 3 Artist title
- 4 Album title
- 5 Elapsed time
- 6 Calendar/Time

<Changer MP3 screen display example (if no tag information exists)>



- 1 Mode display
- 2 Folder name*1
- 3 File name
- 4 Disc number
- 5 Folder number
- 6 File number
- 7 Elapsed time
- 8 Calendar/Time

*1 About Folder Name display, "ROOT" is displayed for the root folder which does not have folder name.

*2 Displayed during playback of a disc with CD Text.

- ID3 tag/WMA tag
If an MP3/WMA/AAC file contains ID3 tag/WMA tag information, the ID3 tag/WMA tag information is displayed.
- The tag information display takes priority. If there is tag information, the folder/file name is not displayed.
- "No Support" is displayed when text information is not compatible with the iDA-X305S.

Playback

- 1 Press **SOURCE** to select the "USB Audio" or "CD CHG" mode.
- 2 Press **◀◀** or **▶▶** to select the desired track (file).

Returning to the beginning of the current track (file):

Press **◀◀**.

Fast backward:

Press and hold **◀◀**.

Advancing to the beginning of the next track (file):

Press **▶▶**.

Fast forward:

Press and hold **▶▶**.

- When a Portable audio player is connected, fast-forwarding/fast-reversing is not available.

- 3 To pause playback, press **▶/||**.
Pressing **▶/||** again will resume playback.

- The playback time may not be correctly displayed when a VBR (Variable Bit Rate) recorded file is played back.

Selecting a Disc (Changer) (Optional)

An optional 6-disc or 12-disc CD Changer may be connected to this unit if it is Ai-NET compatible. With a CD Changer connected to the Ai-NET input of this unit, the CD Changer will be controllable from this unit.

Using the KCA-410C (Versatile Link Terminal) multiple changers can be controlled by this unit.

See "Multi-Changer Selection (Optional)" on page 17 for selecting the CD Changers.

- The controls on this unit for CD Changer operation are operative only when a CD Changer is connected.
- The DVD changer (optional) is controllable from this unit as well as the CD changer.

- 1 Press **PRESET**.
The Disc Select screen is displayed.
- 2 Rotate the **Double Action encoder** to select a disc.
- 3 Press **Q/ENTER**.
The selected disc number appears in the display and CD/MP3 playback starts.

Multi-Changer Selection (Optional)

When using KCA-410C (Versatile Link Terminal), you can connect two changers and two external outputs (AUX).

- 1 Press **SOURCE** on this unit to activate the "CD CHG" mode.
- 2 Press **BAND** to activate the CD Changer Selection mode.
The CD Changer Selection mode remains active for several seconds.
- 3 Press **BAND** until the desired CD Changer appears on the display.

- For further details about the external input (AUX) when using KCA-410C, see "Setting the AUX Mode (V-Link)" on page 24.

Select the desired Folder (Folder up/down) (MP3/WMA/AAC)

Press in the outer ring and rotate the Double Action encoder to the left.

Return to the previous folder.

Press in the outer ring and rotate the Double Action encoder to the right.

Advances to the next folder.



The first file in the selected folder is played back.

- When M.I.X. is played back on the USB memory and Portable audio player, this operation cannot be performed.



Repeat Play

- 1 Press **F** (**FUNCTION/SETUP**).
The Function screen is displayed.
- 2 Press **Q/ENTER**.
The repeat mode is activated.
- 3 Rotate the **Double Action encoder** to select the **Repeat playback mode**.



USB memory/Portable audio player mode :

- Repeat One  : Only a track is repeatedly played back.
- Folder  : Only files in a folder are repeatedly played back.
- Off : Repeat mode is turned off.

CD Changer mode :

- Repeat One  : Only a file is repeatedly played back.
- Folder *  : Only files in a folder are repeatedly played back.
- Disc  : A disc is repeatedly played back.
- Off : Repeat mode is turned off.

* When an MP3 compatible CD changer is connected.

- If Repeat Disc is set to ON during M.I.X. One play in CD changer mode, M.I.X. will apply to the current disc only.
The indicator    appears in the display.

- 4 Press **Q/ENTER**.



- 5 Press **↵**.
The track (file) will be played repeatedly.

- To cancel, select Off in the above procedure.



M.I.X. (Random Play)

- 1 Press **F** (**FUNCTION/SETUP**).
The Function screen is displayed.
- 2 Rotate the **Double Action encoder** to select M.I.X.
- 3 Press **Q/ENTER**.
The M.I.X. mode is activated.
- 4 Rotate the **Double Action encoder** to select the **M.I.X. playback mode**.

USB memory/Portable audio player mode :

- M.I.X. Folder  : Only files in a folder are played back in random sequence.
- All  **ALL** : All songs in USB memory/Portable audio player are played back in random sequence.
- Off : M.I.X. mode is turned off.

CD Changer mode :

- M.I.X. One  : All files in a disc are played back in random sequence, and playback shifts to the next disc.
- Folder *¹  : Only files in a folder are played back in random sequence.
- All *²  : The tracks on all the CDs in the current magazine will be played back in the random sequence.
- Off : M.I.X. mode is turned off.

*¹ When an MP3 compatible CD changer is connected.

*² When a CD changer equipped with the ALL M.I.X. function is connected.

- If M.I.X. One is set to ON during Repeat Disc play in CD changer mode, M.I.X. will apply to the current disc only.

- 5 Press **Q/ENTER**.

- 6 Press **↵**.

The tracks (files) will be played back in random sequence.

- To cancel, select Off in the above procedure.

Searching for CD Track Number (CD changer only)

You can search for a song by track number.

- 1 Press **Q/ENTER** during play.
This will set the search mode.
 - 2 Rotate the **Double Action encoder** to select the **desired track, and then press Q/ENTER**.
This will play the selected track.
- Press **↵** in the search mode to cancel.
 - During list selection, if you press in the outer ring and rotate the **Double Action encoder** to the left or right, the list screen changes screen by screen. If you press then rotate and hold the **Double Action encoder** to the left or right, the list screen continuously changes.
 - CD Track Number search cannot be made during M.I.X. play.

File/Folder Name Search (Concerning MP3/WMA/AAC)

You can display and search for the folder and file name while listening to the file currently being played back.

USB memory mode

- 1 During MP3/WMA/AAC playback, press Q/ENTER to activate the search mode.**
The search mode is activated, and the folder/file name is displayed.
- 2 Rotate the Double Action encoder to select the desired folder/file.**
- 3 Press Q/ENTER.**
If you select a file, the selected file is played back.
If you select a folder, a folder/file(s) in the folder is displayed. Proceed to step 4.
- 4 Perform steps 2 and 3 repeatedly until you find the desired file.**



Portable audio player mode

If a Portable audio player is synchronized by the Windows Media Player (Ver. 10, 11), perform the following.

- 1 Press Q/ENTER to activate the search mode.**
The search mode is activated.
- 2 Rotate the Double Action encoder to select "Music" or "Albums" or "Playlists", and then press Q/ENTER.**
If "Music" is selected, the Artist name list is displayed. Go to step 3.
If "Albums" is selected, go to step 4-1.
If "Playlists" is selected, go to step 4-2.
- 3 Rotate the Double Action encoder to select the desired artist, and then press Q/ENTER.**
An album list of the selected artist is displayed. Go to step 4-1.
- 4-1 Rotate the Double Action encoder to select the desired album, and then press Q/ENTER.**
The song list of the selected album is displayed.
- 4-2 Rotate the Double Action encoder to select the desired playlist, and then press Q/ENTER.**
The song list of the selected playlist is displayed.
- 5 Rotate the Double Action encoder to select the desired song, and then press Q/ENTER.**
The selected song is played back.

MP3 Changer mode

- 1 During MP3 playback, press Q/ENTER to activate the folder search mode.**
The search mode is activated, and the folder name is displayed.
- 2 Rotate the Double Action encoder to select the desired folder, and then press Q/ENTER.**
The File name of the selected folder is displayed.
- 3 Rotate the Double Action encoder to select the desired file, and then press Q/ENTER.**
The selected file is played back.

- If USB memory is connected, the folder/file can be searched up to the eighth hierarchy. The ninth and subsequent folder/file(s) cannot be searched and played back.
- Press and hold  for at least 2 seconds in the search mode to cancel.
- While in the Search mode, press  to switch to the previous mode.
- During list selection, if you press in the outer ring and rotate the **Double Action encoder** to the left or right, the list screen changes screen by screen. If you press then rotate and hold the **Double Action encoder** to the left or right, the list screen continuously changes.
- File/Folder Name search cannot be made during M.I.X. play.
- If there is no file in the folder, nothing is displayed.
- "ROOT" is displayed for the root folder which does not have folder name.
- If a Portable audio player is connected, and only playlists have been created, only "Playlists" are displayed.
- If a portable audio player via USB Mass Storage (not synchronized with Windows Media Player) is connected, refer to the search operation during USB memory connection. Refer also to page 5.

About MP3/WMA/AAC

CAUTION

Except for private use, duplicating audio data (including MP3/WMA/AAC data) or distributing, transferring, or copying it, whether for free or for a fee, without permission of the copyright holder is strictly prohibited by the Copyright Act and by international treaty.

What is MP3?

MP3, whose official name is "MPEG-1 Audio Layer 3," is a compression standard prescribed by the ISO, the International Standardization Organization and MPEG which is a joint activity institution of the IEC.

MP3 files contain compressed audio data. MP3 encoding is capable of compressing audio data at extremely high ratios, reducing the size of music files to as much as one-tenth their original size. This is achieved while still maintaining near CD quality. The MP3 format realizes such high compression ratios by eliminating the sounds that are either inaudible to the human ear or masked by other sounds.

What is AAC?

AAC is the abbreviation for "Advanced Audio Coding," and is a basic format of audio compression used by MPEG2 or MPEG4.

What is WMA?

WMA, or "Windows Media™ Audio," is compressed audio data. WMA is similar to MP3 audio data and can achieve CD quality sound with small file sizes.

Method for creating MP3/WMA/AAC files

Audio data is compressed by using MP3/WMA/AAC specified software. For details on creating MP3/WMA/AAC files, refer to the user's manual for that software.

MP3/WMA/AAC file extensions that can be played back on the unit are as follows:

MP3: ".mp3"

WMA: ".wma" (ver. 7.1, 8, 9, 9.1, 9.2 supported)

AAC: ".m4a"

WMA is not supported for the following files, Windows Media Audio Professional, Windows Media Audio 9 Voice or Windows Media Audio 9 Pro Lossless.

Depending on the software that is used to create AAC, the file format may differ from the extension.

Unit playback of AAC files encoded by version 7.7 iTunes is supported.

Supported playback sampling rates and bit rates

MP3

Sampling rates: 48 kHz, 44.1 kHz, 32 kHz, 24 kHz, 22.05 kHz, 16 kHz, 12 kHz, 11.025 kHz, 8 kHz

Bit rates: 16 - 320 kbps

WMA

Sampling rates: 48 kHz, 44.1 kHz, 32 kHz, 24 kHz, 22.05 kHz, 16 kHz

Bit rates: 16 - 320 kbps

AAC

Sampling rates: 48 kHz, 44.1 kHz

Bit rates: 16 - 320 kbps

This device may not play back correctly depending on sampling rates.

ID3 tags/WMA tags

This device supports ID3 tag v1 and v2.2.0, v2.3.0 and WMA tag. The following files do not support compression, coding, grouping or non-synchronization.

If tag data is in an MP3/WMA/AAC file, this device can display the title (track title), artist name, and album name ID3 tag/WMA tag data.

This device can only display single-byte alphanumeric characters and the underscore. For non-supported characters, "No Support" is displayed.

The tag information may not be correctly displayed, depending on the contents.

Playing back MP3/WMA/AAC

MP3/WMA/AAC files are prepared, and then written to USB memory. Or, synchronize an MP3/WMA file using Windows Media Player (Ver. 10 or 11), and then forward to the Portable audio player.

A USB memory device can hold up to 10,000 files/1,000 folders (including Root Folders). Playback may not be performed if a USB memory / Portable audio player device exceeds the limitations described above.

Media supported

This device can play back USB memory / Portable audio player media.

Corresponding File Systems

This device supports FAT 12/16/32.

Terminology

Bit rate

This is the "sound" compression rate specified for encoding. The higher the bit rate, the higher the sound quality, but also the larger the files.

Sampling rate

This value shows how many times per second the data is sampled (recorded). For example, music CDs use a sampling rate of 44.1 kHz, so the sound is sampled (recorded) 44,100 times per second. The higher the sampling rate, the higher the sound quality, but also the larger the volume of data.

Encoding

Converting music CDs, WAVE (AIFF) files, and other sound files into the specified audio compression format.

Tag

Song information such as track titles, artist names, album names, etc., written into MP3/WMA/AAC files.

Root folder

The root folder is found at the top of the file system. The root folder contains all folders and files.

Sound Setting

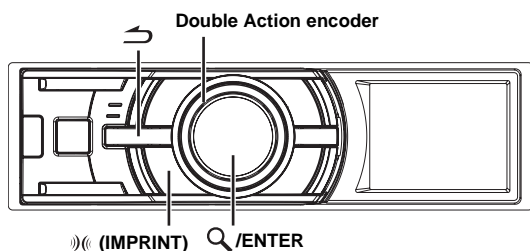

If either an external or IMPRINT audio processor is connected, the Sound Setup screen is not displayed. For an external audio processor, refer to "Audio Setting" (page 26) of "SETUP" (page 23) to adjust the sound. For an IMPRINT audio processor, refer to "IMPRINT Operation (Optional)" (page 32) to adjust the sound.

Adjusting Subwoofer/Bass/Treble/Balance (Between Left and Right)/Fader (Between Front and Rear)/Loudness/Defeat

- 1 Press **IMPRINT** repeatedly to choose the desired mode.

Each press changes the mode as follows:

Subwoofer*¹ → Bass Level → Treble Level → Balance → Fader → Loudness → Defeat → Volume → Subwoofer

Subwoofer: 00 ~ 15
Bass level: -7 ~ +7
Treble level: -7 ~ +7
Balance: Left15 ~ Right15
Fader: Rear15 ~ Front15
Loudness : ON/OFF
Defeat : ON/OFF
Volume: -∞ ~ 0 dB

- Loudness introduces a special low and high frequency emphasis at low listening levels. This compensates for the ear's decreased sensitivity to bass and treble sound. The function is inoperable when Defeat is set to ON.
- By setting Defeat ON, previously adjusted setting of Bass, Treble and High Pass Filter will return to the factory defaults.
- If **IMPRINT** is not pressed for 15 seconds after selecting the Subwoofer, Bass, Treble, Balance or Fader mode, the unit automatically returns to normal mode.

*¹ When the subwoofer mode is set to OFF, its level cannot be adjusted.

- 2 Rotate the **Double Action encoder** until the desired sound is obtained in each mode.

- Depending on the connected devices, some functions do not work.
- You can store the contents of Balance/Fader/Loudness settings after completing. For how to store, refer to "Storing the Audio Adjustment Level (User Preset)" (page 26).

Setting the Bass Control

You can change the Bass Frequency emphasis to create your own tonal preference.

- 1 Press and hold **IMPRINT** for at least 2 seconds. The Sound Setup screen is displayed.
- 2 Press **Q/ENTER**. The Bass Adjustment setting mode is activated.

Setting the Bass Center Frequency

- 3 Press **Q/ENTER**. The F₀ setting screen is displayed.
- 4 Press **Q/ENTER**.
- 5 Rotate the **Double Action encoder** to select the desired bass center frequency, and then press **Q/ENTER**.

60 Hz ↔ 80 Hz ↔ 100 Hz ↔ 200 Hz

Emphasizes the displayed bass frequency ranges.

- 6 Press **↶** to return to Bass Adjustment mode.

Setting the Bass Bandwidth

- 3 Rotate the **Double Action encoder** to select "Q", and then press **Q/ENTER**. The Q setting screen is displayed.
- 4 Press **Q/ENTER**.
- 5 Rotate the **Double Action encoder** to select the desired bass bandwidth.

1 ↔ 1.25 ↔ 1.5 ↔ 2







Changes the boosted bass bandwidth to wide or narrow. A wider setting will boost a wide range of frequencies above and below the center frequency. A narrower setting will boost only frequencies near the center frequency.

- 6 Press **↶** to return to Bass Adjustment mode.

- If **↶** is pressed during setting, the unit returns to the previous item.
- The function is inoperable when Defeat is set to ON.
- You can adjust the bass level in normal mode. For details, refer to "Adjusting Subwoofer/Bass/Treble/Balance (Between Left and Right)/Fader (Between Front and Rear)/Loudness/Defeat" (page 21).
- After the setting, storing the setting contents on the unit is recommended. For details, refer to "Storing the Audio Adjustment Level (User Preset)" (page 26).
- The bass level settings will be individually memorized for each source (FM, AM, CD, etc.) until the setting is changed. The bass frequency and bass bandwidth settings adjusted for one source are effective for all other sources (FM, AM, CD, etc.)

Setting the Treble Control





You can change the Treble Frequency emphasis to create your own tonal preference.

- 1 Press and hold  (IMPRINT) for at least 2 seconds.**
The Sound Setup screen is displayed.
- 2 Rotate the Double Action encoder to select the “Treble Adjustment”, and then press .**
- 3 Press .**
The F₀ setting screen is displayed.
- 4 Press .**
- 5 Rotate the Double Action encoder to select the desired treble center frequency, and then press .**
10 kHz ↔ 12.5 kHz ↔ 15 kHz ↔ 17.5 kHz
Emphasizes the displayed treble frequency ranges.
- 6 Press and hold  for at least 2 seconds to return to normal mode.**

- If  is pressed during setting, the unit returns to the previous item.
- The function is inoperable when Defeat is set to ON.
- You can adjust the treble level in normal mode. For details, refer to “Adjusting Subwoofer/Bass/Treble/Balance (Between Left and Right)/Fader (Between Front and Rear)/Loudness/Defeat” (page 21).
- After the setting, storing the setting contents on the unit is recommended. For details, refer to “Storing the Audio Adjustment Level (User Preset)” (page 26).

Adjusting the High Pass Filter





The High Pass Filter on this unit can be adjusted to suit your personal taste.

- 1 Press and hold  (IMPRINT) for at least 2 seconds.**
The Sound Setup screen is displayed.
- 2 Rotate the Double Action encoder to select “High Pass Filter Adjustment”, and then press .**
- 3 Rotate the Double Action encoder to select the desired HPF frequency, and then press .**
80 Hz ↔ 120 Hz ↔ 160 Hz ↔ off
- 4 Press  to return to normal mode.**
 - If  is pressed during setting, the unit returns to the previous item.
 - The function is inoperable when Defeat is set to ON.
 - After setting, storing the setting contents is recommended. For how to store, refer to “Storing the Audio Adjustment Level (User Preset)” (page 26).

Turning Subwoofer ON/OFF

If an optional subwoofer is connected to the unit, make the following setting.

When the subwoofer is on, you can adjust the subwoofer output level (refer to page 21).

- 1 Press and hold  (IMPRINT) for at least 2 seconds.**
The Sound Setup screen is displayed.
- 2 Rotate the Double Action encoder to select “Subwoofer”, and then press .**
- 3 Rotate the Double Action encoder to select ON/OFF, and then press .**
- 4 Press  to return to normal mode.**
 - If  is pressed during setting, the unit returns to the previous item.
 - You can set the subwoofer output level in normal mode. Refer to “Adjusting Subwoofer/Bass/Treble/Balance (Between Left and Right)/Fader (Between Front and Rear)/Loudness/Defeat” (page 21).
 - You can set the subwoofer system in SETUP mode. Refer to “Setting the Subwoofer (Subwoofer System)” (page 27).

SETUP

Use the SETUP menu to flexibly customize the unit to suit your own preferences and usage. Choose settings from General, Display, etc., to make the desired changes.

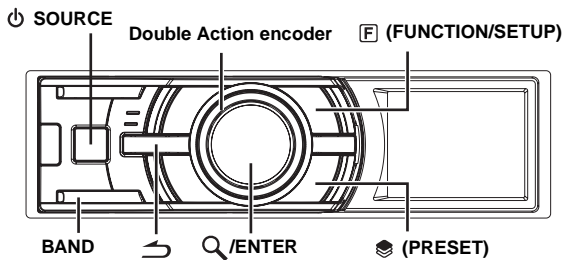

Follow steps 1 to 5 to choose an item to change. See the individual item descriptions following Step 5 for further details.

1 Press and hold [F] (FUNCTION/SETUP) for at least 2 seconds to activate the SETUP selection mode.

2 Rotate the Double Action encoder to select the desired item, and then press Q/ENTER.

BLUETOOTH ↔ General ↔ Display ↔ iPod ↔ XM* ↔ SIRIUS* ↔ HD Radio* ↔ Audio
(e.g. Select General)

* Only when HD Radio Tuner/SAT receiver is connected.

3 Rotate the Double Action encoder to select a setting item, and then press Q/ENTER.
(e.g. Select Beep)

BLUETOOTH:
BLUETOOTH IN

General:

Clock Mode ↔ Clock Adjust*¹ ↔ Calendar Type ↔ Daylight Time ↔ Play Mode ↔ Beep ↔ Int Mute ↔ Int Audio ↔ CHG Name*² ↔ AUX IN ↔ AUX+ ↔ AUX Name*³ ↔ AUX+ IN GAIN*⁴ ↔ Power IC ↔ Language ↔ Demo

Display:

Illumination ↔ Dimmer ↔ Dimmer Level ↔ Text Scroll ↔ BGV Select ↔ BGV Color ↔ BGV Download

iPod:

Playlists ↔ Artists ↔ Albums ↔ Podcasts ↔ Audiobooks ↔ Genres ↔ Composers ↔ Songs

XM*⁵:

XM ADF

SIRIUS*⁵:

Game Alert

HD Radio*⁶:

Station Call ↔ Digital Seek

Audio*⁷:

User Preset ↔ MX*⁸ ↔ Subwoofer*⁸ ↔ Subwoofer System*⁹ ↔ MX Level Adjustment*^{8,10}

*¹ Refer to "Setting the Time and Calendar" (page 7).

*² The setting can be made only when a changer is connected.

*³ The setting can be made only when AUX IN is set to ON.

*⁴ The setting can be made only when AUX+ is set to ON.

*⁵ Displayed only when SAT radio receiver is connected.

For the SAT Radio Setting, refer to "SAT Radio Receiver (Optional)" (page 27).

*⁶ Displayed only when HD Radio TUNER MODULE is connected.

*⁷ If IMPRINT audio processor is connected, you can make more detailed settings for the audio setting. For details, refer to "IMPRINT Operation (Optional)" (page 32).

*⁸ The adjustment can be made only when an external audio processor is connected. Refer to the Owner's Manual of the external audio processor.

*⁹ The setting is available only when Subwoofer is set to ON.

*¹⁰ The setting is available only when MX is set to ON.

4 Rotate the Double Action encoder to change the setting, and then press Q/ENTER.
(e.g. Select Beep On or Beep Off.)

5 Press and hold [↵] for 2 seconds to return to normal mode.

- Pressing [↵] during the procedure will return to the previous mode.
- During setup, if you press in the outer ring and rotate the Double Action encoder to the left or right, the setting item selection screen changes page by page. If you press then rotate and hold the Double Action encoder to the left or right, the setting item selection screen continuously changes page by page.

BLUETOOTH Setting

Select "BLUETOOTH" from the setup main menu in step 2 above.

If an optional BLUETOOTH INTERFACE (KCE-400BT) is connected, you can place a hands-free call by a BLUETOOTH-equipped mobile phone.

Make this setting when the BLUETOOTH INTERFACE is connected and the BLUETOOTH function is used. For details, refer to the Owner's Manual of the optional BLUETOOTH INTERFACE.

- When Int Mute is set to On, the BLUETOOTH setting cannot be made. When the BLUETOOTH INTERFACE is connected, set Int Mute to Off. Refer to "Turning Mute Mode On/Off (Int Mute)" (page 24).

Setting the BLUETOOTH Connection (BLUETOOTH IN)

BLUETOOTH IN Adapter / BLUETOOTH IN Off (Initial Setting)

General Setting

“General” is selected on the setup main menu in step 2.

Setting the Clock Display (Clock Mode)

24H Type / 12H Type (Initial setting)

You can select the clock display type, 12-hour or 24-hour, depending on your preference.

Setting of Calendar Display Pattern Switching (Calendar Type)

M/D/Y (Initial setting) / D/M/Y / Y/M/D

You can switch the calendar display pattern to be shown when the time is displayed.

- Y : shows the year
M : shows the month
D : shows the day
ex. M/D/Y → Dec/31/2009

Setting Daylight Saving Time (Daylight Time)

On / Off (Initial setting)

- On: Turn Daylight Saving Time mode ON. The time advances by one hour for areas observing Daylight Saving Time.
Off: Return to the ordinary time.

Connecting an MP3 Changer (Play Mode)

CDDA (Initial setting) / CDDA & MP3

Perform this setting when connecting MP3 changer. MP3 changer can playback CDs containing both CD and MP3 data. However, in some situations (some enhanced CDs), playback may be difficult. For these special cases, you can select playback of CD data only. When a disc contains both CD or the MP3 data, playback starts from the CD data portion of the disc.

- CDDA : Only CD data can be played back.
CDDA & MP3 : Both CD data and MP3 file tracks can be played back.

- Change discs after performing this setting.

Sound (Beep) Guide Function

Beep On (Initial setting) / Beep Off

This function will give audible feedback with varying tones depending upon the button pressed.

Turning Mute Mode On/Off (Int Mute)

Int Mute On (Initial setting) / Int Mute Off

If a device having the interrupt feature is connected, audio will be automatically muted whenever the interrupt signal is received from the device.

- When **BLUETOOTH** is set to Adapter, Int Mute cannot be set. Refer to “Setting the **BLUETOOTH** Connection (**BLUETOOTH** IN)” (page 23).
- When the **BLUETOOTH** INTERFACE is connected, set Int Mute to Off.

Setting Tone Defeat for External Devices (Int Audio)

Int Audio On / Int Audio Off (Initial setting)

When inputting external devices to this unit, turning tone defeat on will bypass Bass Frequency, Treble Frequency, High Pass Filter, i.e., sound for external devices is output at the default setting.

Setting the Changer Name (CHG Name)

CHG (Initial setting) / PMD

When an optional changer is connected, you can set the displayed mode name.

- The setting can be made only when a changer is connected. When two changers are connected, the CHG1 Name/CHG2 Name is displayed, and the setting can be made respectively.

Setting the AUX Mode (V-Link)

AUX IN On / AUX IN Off (Initial setting)

You can input TV/video sound by connecting an optional Versatile Link Terminal (KCA-410C) to this component.

You can change the AUX name display when AUX IN is set to On.

When AUX IN is set to On, select the “AUX Name” mode by rotating the **Double Action encoder**, then press **Q/ENTER**.

After that, rotate the **Double Action encoder** to select the desired AUX name, then press **Q/ENTER**.

If the KCA-410C is connected, it is possible to select two AUX names.

- Via KCA-410C, up to 2 external devices with RCA output can be connected. In this case, press **⏻** SOURCE to select AUX mode and then press **BAND** to select your desired device.

Setting the AUX+ Mode

AUX+ On / AUX+ Off (Initial setting)

You can input the audio of an external device, (such as a Portable audio player) to the **BLUETOOTH** interface connector of this unit. A special Conversion cable (KCE-237B) is necessary to adapt the **BLUETOOTH** interface connector as an AUX IN.

- AUX+ On : Set to On when an external device is connected. If **⏻** SOURCE is pressed and Auxiliary+ is selected, the sound of the external device is input to the unit.
AUX+ Off : Set to Off when a **BLUETOOTH** INTERFACE is connected.

AUX+ Audio Level Adjustment (AUX+ IN GAIN)

High (Initial setting) / Low

- Low: Decreases the external input audio level
High: Increases the external input audio level

Connecting to an External Amplifier (Power IC)

Power IC On (Initial setting) / Power IC Off

When an external amplifier is connected, sound quality can be improved by stopping the power supply of the built-in amplifier.

Power IC Off : Use this mode when the front and rear pre-amplifiers of the unit are used to drive an external amplifier connected to the speakers. In this setting, the head unit's internal amplifier has no output to drive speakers.

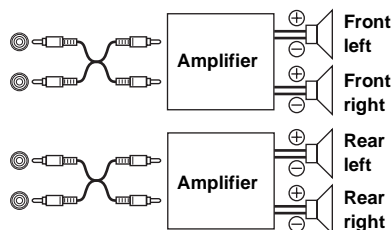

Power IC On : The speakers are driven by the built-in amplifier.

- No sound is produced by the system when the power output is set to OFF.

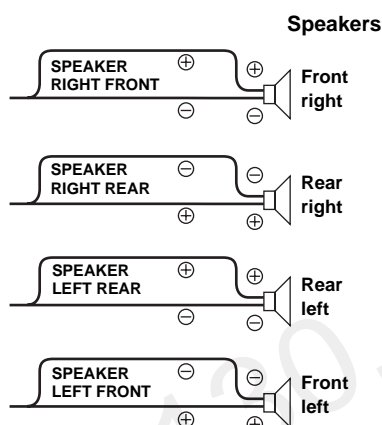

Setting the Language (Language)

For US (Initial setting) / For EU1 / For EU2 / For Japan / Other

Set the language to be displayed on the unit. Set to For US to use the setting.

For US :	English, French, Spanish
For EU1 :	Russian, English
For EU2 :	English, German, French, Spanish, Italian, Swedish, Portuguese
For Japan :	Japanese, English
Other :	Chinese (Chinese standard), English

Demonstration (Demo)

Demo On / Demo Off (Initial setting)

This unit has a Demonstration feature for the display.

- To quit Demo mode, set to Demo OFF.

Display Setting

“Display” is selected on the setup main menu in step 2.

Changing Lighting Color (Illumination)

Illumination Blue (Initial setting) / Illumination Red

You can change the lighting color of the buttons.

Dimmer Control (Dimmer)

Dimmer On / Dimmer Off (Initial setting)

Set the Dimmer control to On to decrease the illumination brightness of the unit with the head lights of the vehicle ON. This mode is useful if you feel the unit's backlighting is too bright at night.

Setting the Display Dimmer (Dimmer Level)

Dimmer Level1 (Initial setting) / Level2 / Level3

In the display Dimmer On setting, three levels are available, the highest level (Level3) being the dimmest when the car headlights are on.

Scroll Setting (Text Scroll)

Text Scroll Type1/Type2 / Off (Initial setting)

You can set a scroll type such as song title or file name on the source screen. If the search mode screen displays fills with text, the display scrolls.

Also, you can select the desired scroll type.

Type1/Type2 :	Text information are scrolled automatically.
Off :	The first display scrolls text information one time only.

- In parts of the display, scrolling may not occur, or scroll content may differ.
- Regardless of this setting, if the display is filled with text, the display scrolls.

Switching the Display Type (BGV Select)

BGV Select Type 1 (Initial setting) / Type 2 / Type 3 / User

You can select your favorite display for background from 3 types.

To display downloaded data on the unit, select User. Refer to “Downloading the Wallpaper (BGV Download)” (page 26).

Setting the Wallpaper Color (BGV Color)

BGV Color Type 1 (Initial setting) / Type2

You can select the background color of the display between two types.

Type1 :	Blue
Type2 :	Red

Downloading the Wallpaper (BGV Download)

Wallpapers are downloaded only when in USB memory mode.

Wallpaper data is available at a web site designed for Alpine product Owners. Download the wallpaper to your USB flash memory. Upload the Wallpaper from the flash memory to your unit.

To start the download, access the URL below and follow the on-screens instructions.

<https://i-personalize.alpine.com/>

1 Rotate the Double Action encoder to select “BGV Download”, and press Q/ENTER.

Data in the USB memory is searched and maximum 10 files are displayed.

2 Rotate the Double Action encoder to select a file, and press Q/ENTER.

The selected file is downloaded to the unit.

- The downloaded data extension is “apn”.
- You cannot display your own wallpaper you made.
- To display the wallpaper you have downloaded to the unit, select User in “Switching the Display Type (BGV Select)” (page 25).

iPod/iPhone Setting

“iPod” is selected on the setup main menu in step 2.

iPod/iPhone Search Mode Setting

On / Off

The unit allows you to search for the iPod/iPhone using eight different search modes.

When the search mode is in Playlists/Artists/Albums/Podcasts/Audiobooks, the initial setting is On, and when the search mode is in Genre/Composers/Songs, the initial setting is Off.

- For search mode details, refer to “Searching for a desired Song/Title” (page 11).

HD Radio™ Setting (Only when HD Radio Tuner is connected)

“HD Radio” is selected on the setup main menu in step 2.

HD Radio Station Call Setting (Station Call)

Station Call Long / Station Call Short (Initial setting)

In the HD Radio mode, the number of display characters for the HD Radio station name can be selected.

Long : 56 characters
Short : 8 characters (FM)
4 characters (AM)

Digital Seek On/Off Setting (Digital Seek)

Digital Seek On / Digital Seek Off (Initial Setting)

On : SEEK UP/DOWN is used only for Digital Radio Station.
Off : SEEK UP/DOWN is used for all Radio Stations.

Audio Setting

“Audio” is selected on the setup menu in step 2.

- If IMPRINT audio processor is connected, you can make more detailed settings for the audio setting. For details, refer to “IMPRINT Operation (Optional)” (page 32).

Storing the Audio Adjustment Level (User Preset)

You can store up to 6 adjusted/set contents on this unit.

All of the following adjusted/set items are stored in a preset memory.

Items to be adjusted/set	Reference page
Balance adjustment	Page 21
Fader adjustment	Page 21
Loudness setting	Page 21
Setting the Bass Center Frequency	Page 21
Setting the Treble Center Frequency	Page 22
Setting the HPF	Page 22

1 Rotate the Double Action encoder to select “User Preset”, and then press Q/ENTER.

The User Preset screen is displayed.

2 Rotate the Double Action encoder to select a preset number, and press and hold Q/ENTER for at least 2 seconds.

Adjusted/set contents are stored in the selected preset number.

- The User Preset screen can also be recalled in normal mode by pressing and holding  (PRESET) for at least 2 seconds.

Recalling the Audio Adjustment Level

You can recall the contents stored in “Storing the Audio Adjustment Level (User Preset)” (page 26).

1 Rotate the Double Action encoder to select “User Preset”, and then press Q/ENTER.

The User Preset screen is displayed.

2 Rotate the Double Action encoder to select a preset number, and press Q/ENTER.

Adjusted/set contents of the selected number are recalled.

- The User Preset screen can also be recalled in normal mode by pressing and holding  (PRESET) for at least 2 seconds.

Turning Media Xpander ON/OFF (MX)

MX On / MX Off (Initial Setting)

When the Media Xpander is on, and external audio processor is connected, you can adjust the Media Xpander level (For details, refer to external audio processor's Owner's manual).

- Displayed only when external audio processor is connected.

Setting the MX Level (MX Level Adjustment)

Non Effect / Level 1 / Level 2 / Level 3 (Initial Setting)

MX (Media Xpander) makes vocals or instruments sound distinct regardless of the music source. The FM radio, CD, USB memory and iPod/iPhone, will be able to reproduce the music clearly even in cars with a lot of road noise.

- Displayed only when external audio processor is connected, and MX is set to ON.

Subwoofer On and Off (Subwoofer)

Subwoofer On (Initial setting) / Subwoofer Off

If an optional subwoofer is connected to the unit, make the following setting.

- Displayed only when external audio processor is connected.

Setting the Subwoofer (Subwoofer System)

Sys 1 (Initial Setting) / Sys 2

The setting is available only when "Turning Subwoofer ON/OFF" (page 22) is set to On.

- Sys 1 : Subwoofer level changes according to the main volume setting.
- Sys 2 : Subwoofer level change is different from the main volume setting. For example, even at low volume settings, the subwoofer is still audible.

SAT Radio Receiver (Optional)

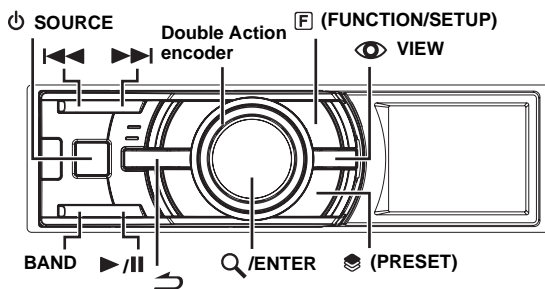

SAT Receiver: XM or SIRIUS Receiver
When an optional XM or SIRIUS Receiver Box is connected via the Ai-NET bus, the following operations may be performed. However, the XM Receiver and SIRIUS Receiver cannot be connected at the same time.

SIRIUS Receiver: Verify the features of the connected SIRIUS Receiver Box. Not all SIRIUS Receivers have identical functions and some may not be performed on this unit. For details about individual functions, refer to the SIRIUS Receiver's Owner's Manual.

How to View the Display

<XM screen display example>

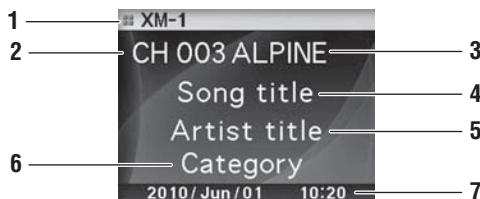

- 1 Mode display
- 2 Channel number
- 3 Radio station name
- 4 Song title
- 5 Artist title
- 6 Category name
- 7 Calendar/Time

<SIRIUS screen display example>

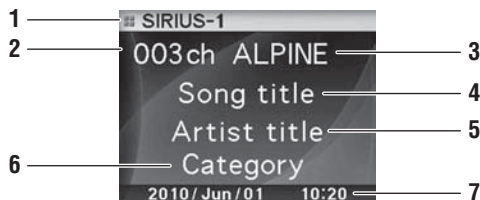

- 1 Mode display
- 2 Channel number/Presets number
- 3 Radio station name
- 4 Song title
- 5 Artist title
- 6 Category name (Composer name)
- 7 Calendar/Time

Receiving Channels with the SAT Radio Receiver (Optional)

About SAT Radio

Satellite Radio* is the next generation of audio entertainment, with over 100 digital audio channels. For a small monthly fee, subscribers can hear crystal-clear music, sports, news and talk, coast-to-coast via satellite. For more information, visit XM's website at www.xmradio.com, or SIRIUS' website at www.sirius.com.

To receive SAT Radio, the separately sold XM Direct™ or SIRIUS Satellite Radio Tuner and an appropriate Ai-NET Interface Adapter will be required. For details, consult your nearest Alpine dealer.

- *The SAT Receiver controls on the iDA-X305S are operative only when a SAT Receiver is connected.*

1 Press  SOURCE to activate the SAT Radio mode.

2 Press BAND to select one of the three SAT Radio Preset Bands.

Each press changes the band:

XM mode:

XM-1 → XM-2 → XM-3 → XM-1

SIRIUS mode:

SIRIUS-1 → SIRIUS-2 → SIRIUS-3 → SIRIUS-1

3 Press  or  to select the desired channel.

Holding down  or  will change channels continuously.

- *When using the optional remote control (RUE-4190, etc.), an SAT Radio Channel can be directly called up with the numeric keypad of the remote control.*

1 While in XM or SIRIUS Radio mode, enter the Channel number you want to call up with the numeric keypad on the remote control.

2 Press ENTER on the remote control within 5 seconds to receive the Channel.

If the channel number is 3 digits, the Channel is automatically received after the channel number has been input.



Checking the SAT Radio ID Number

A unique Radio ID number is required to subscribe to SAT Radio programming. Each third party XM or SIRIUS radio comes with this number.

This number is an 8 character (for XM Radio) or 12 character (for SIRIUS Radio) alphanumeric number. It is printed on a label found on the SAT Receiver.

It can also be displayed on the screen of the iDA-X305S in the following way.

XM:

1 While receiving a XM Radio band, press  or  to select channel "0" for XM.

2 To cancel the ID number display, select the channel other than "0."

SIRIUS:

1 While receiving a SIRIUS Radio band, press  or  to select channel "255" for SIRIUS.

2 To cancel the ID number display, set the channel to other than "255".

- *You cannot use "O," "S," "I," or "F" for the ID Number (XM radio Receiver only).*
- *You can check the ID number printed on a label on your third party, SAT Radio Receiver package.*

Storing Channel Presets

1 Press BAND to select the desired band you want to store.

2 Press  (PRESET).
The Preset screen is displayed.

3 Rotate the Double Action encoder to select the preset number.

4 Press and hold /ENTER for at least 2 seconds.
The selected station is stored.

5 Repeat the procedure to store up to 5 other channels onto the same band.

- *To use this procedure for other bands, simply select the band desired and repeat the procedure.*
- *A total of 18 channels can be stored in the preset memory (6 channels for each band; XM-1, XM-2 and XM-3 or SIRIUS-1, SIRIUS-2 and SIRIUS-3).*
- *If you store a channel in a preset memory which already has a station, the current channel will be cleared and replaced with the new one.*

Receiving Stored Channels

1 Press BAND to select the desired band.

2 Press  (PRESET).
The Preset screen is displayed.

3 Rotate the Double Action encoder to select a radio station.

4 Press /ENTER.

Storing the desired Sports Team (SIRIUS only)

Store a favorite team from one of the available leagues SIRIUS covers. Once stored, game times and scores for that team are announced using the interruption Alert display while receiving other programming. To receive these announcements, refer to page 29.

This function becomes effective after performing the following two operations.

Storing while receiving a game broadcast

- 1 Select the channel broadcasting your favorite team's game.
- 2 Press **F** (**FUNCTION/SETUP**) to activate the Function mode.
- 3 While selecting "Alert Memory", press **Q/ENTER** to activate the Memory mode.
- 4 Rotate the **Double Action encoder** to select the desired team for the game being broadcast, and then press **Q/ENTER**.
- 5 Rotate the **Double Action encoder** to select alert type, and then press **Q/ENTER**.

Initial (Initial setting) ↔ Update

Initial: The Alert display interrupts when the game begins.
Update: The Alert display interrupts by game progress (change of score, game result, etc.).

- 6 Press **↵** to cancel the Function mode.

Game Alert Setup

- 1 Press and hold **F** (**FUNCTION/SETUP**) for at least 2 seconds to enter the Setup mode.
- 2 Rotate the **Double Action encoder** to select a SIRIUS item, and then press **Q/ENTER**.
- 3 Press **Q/ENTER** to select "Game Alert".
- 4 Rotate the **Double Action encoder** to select the desired league, and then press **Q/ENTER**.
- 5 Rotate the **Double Action encoder** to select a team you want to store, and then press **Q/ENTER**.
- 6 Rotate the **Double Action encoder** to select an alert type, and then press **Q/ENTER**.

Initial (Initial setting) ↔ Update

Initial: The Alert display interrupts when the game begins.
Update: The Alert display interrupts by game progress (change of score, game result, etc.).

- 7 Press and hold **↵** for at least 2 seconds to cancel the SETUP mode.
- Pressing **↵** returns to the previous Setup mode.
 - If **↵** is pressed and held for at least 2 seconds, the setting mode is canceled.
 - You can store a maximum of one team per league.

Storing the desired Song/Artist (SIRIUS only)

A stored song title or artist name is announced whenever a matching title or artist is found on another channel. The interruption Alert is displayed while listening to a program on another channel. For receiving interruption information, refer to "Recalling the stored information (SIRIUS only)" (page 29).

- 1 Press **F** (**FUNCTION/SETUP**) to activate the Function mode when a Song or the song of an Artist you want to store is being broadcast.
 - 2 While selecting "Alert Memory", press **Q/ENTER** to activate the Memory mode.
 - 3 Rotate the **Double Action encoder** to select "Song" or "Artist", and then press **Q/ENTER**.
 - 4 Rotate the **Double Action encoder** to select the song name or artist name, and then press **Q/ENTER**.
 - 5 Press **↵** to cancel the Function mode.
- If you try to store a Song/Artist into a memory that is full, the Alert list is displayed. Select a Song title or Artist name that you want to replace and then press **Q/ENTER**.

Recalling the stored information (SIRIUS only)

Whenever the stored sports team, song(s) or artist(s) are playing, an interruption Alert appears in the display of the unit.

- 1 After displaying "Game Alert," "Song Alert" or "Artist Alert," the corresponding alert list will be automatically displayed.
 - 2 Rotate the **Double Action encoder** to select the desired information.
 - 3 Press **Q/ENTER**.
The selected channel containing the desired information is received.
- If no operation is performed for 10 seconds, the unit returns to normal mode.
 - Only a single sports team, song or artist can be displayed as an interruption Alert. For example, both song and artist cannot be displayed as an Alert at the same time.

Canceling the stored Alert Memory (SIRIUS only)

- 1 During usual reception, press **F** (**FUNCTION/SETUP**) to turn the Function mode.
- 2 Rotate the **Double Action encoder** to select "Alert Delete", and press **Q/ENTER**.
The memory list appears.
- 3 Rotate the **Double Action encoder** to select an alert you want to delete, and then press **Q/ENTER**.
- 4 Press **↵** to cancel the Function mode.

Search Function

You can search for programs by Category, Channel, Artist or Song.

1 Press **Q/ENTER** in the XM or SIRIUS mode.

2 Rotate the **Double Action encoder** to select **Search mode**, and then press **Q/ENTER**.

Artist* ↔ Song* ↔ Category ↔ Channel

* SIRIUS Only

Category Search mode:

3 Rotate the **Double Action encoder** to select the desired **Category**, and then press **Q/ENTER**.

4 Rotate the **Double Action encoder** to select the desired **Channel Name**, and then press **Q/ENTER**.

- While in Category Search mode, press **↶** to return to the selecting search mode.
- The Search mode is canceled if you press and hold **↶** for at least 2 seconds in Category Search mode.
- During list selection, if you press in the outer ring and rotate the **Double Action encoder** to the left or right, the list screen changes screen by screen. If you press then rotate and hold the **Double Action encoder** to the left or right, the list screen continuously changes.
- If Alert interruption occurs in the search mode, the search mode is canceled.

Channel/Artist/Song Search mode:

3 Rotate the **Double Action encoder** to select the desired **Channel/Artist/Song Name**, and then press **Q/ENTER**.

- While in Channel/Artist/Song Search mode, press **↶** to return to the selecting search mode.
- The Search mode is canceled if you press and hold **↶** for at least 2 seconds in Channel/Artist/Song Search mode.
- Channel search is possible only in the category (last mode).
- During list selection, if you press in the outer ring and rotate the **Double Action encoder** to the left or right, the list screen changes screen by screen. If you press then rotate and hold the **Double Action encoder** to the left or right, the list screen continuously changes.
- If Alert interruption occurs in the search mode, the search mode is canceled.

Select the desired Category (Category up/down)

1 Press in the outer ring and rotate the **Double Action encoder** to the left or right.

Turning to the right will advance to the next Category.
Turning to the left will return to the previous Category.
The first channel in the selected Category is played back.

Receiving Weather or Traffic Information from SAT Radio

1 Select the **SAT Radio Channel** for your local traffic/weather information.

2 Press and hold **▶/||** for at least 2 seconds in the **SAT mode**.

The received weather or traffic channel is stored.

3 Press and hold **BAND** for at least 2 seconds.

The stored Weather or Traffic channel will be recalled.

4 Press and hold **BAND** for at least 2 seconds.

Returns to normal mode.

- Channel other than Weather or Traffic can also be stored and recalled.

Instant Replay Function (SIRIUS only)

In SIRIUS mode, the current channel is saved using the Instant Replay memory function. Use this function to pause the channel content at any time. When playback is continued, it will begin at the position it was paused. This function can be used to store up to 44 minutes of audio.

1 During SIRIUS reception, press **▶/||** to select the **Instant Replay mode**.

"Pause" is displayed, and the received station is stored.

2 Press **▶/||** again to select the **play mode**.

The stored contents are played back.

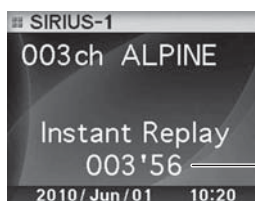

Play Time
(Remaining time for
Instant Replay.)

During Instant Replay playback:

Fast reverse: Press and hold **◀◀**.

Fast forward: Press and hold **▶▶**.

- If you continue to press Fast forward until the end, the Instant Replay mode is canceled, and the unit will change to usual reception.

3 Press **↶** for at least 2 seconds to cancel the **Instant Replay mode**.

The unit returns to usual SIRIUS broadcasting mode.

Changing the Display

Text information, such as the channel name, artist name/feature, and song/program title, is available with each XM or Sirius channel. The unit can display this text information as explained below.

In XM or SIRIUS mode, press  VIEW.

Each time you press this button, the display changes as shown below.

XM mode:

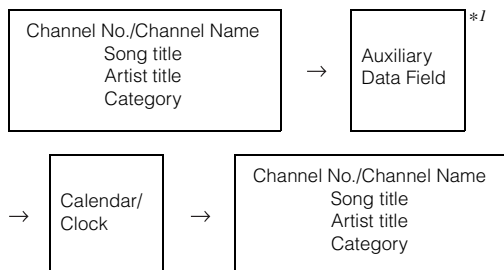

SIRIUS mode:

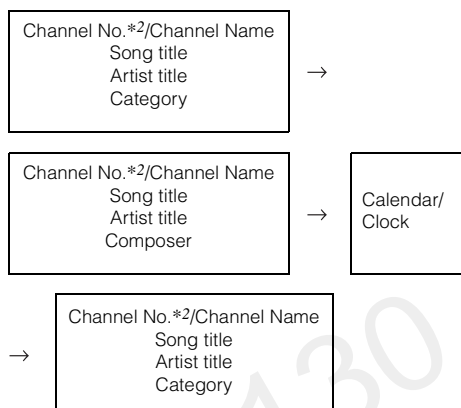







^{*1} When ADF is turned OFF, this information is not displayed (see "Setting the Auxiliary Data Field Display" on page 31).

^{*2} If a channel is stored in the preset No., the channel No. and preset No. will be alternately displayed.

- When the "Scroll Setting (Text Scroll)" (page 25) is set to "Auto," the channel name and song title scrolls continuously. When the Scroll Setting is set to "Manual," the channel name and song title scrolls only once.
- Depending on the model, the display may differ from the one shown above.

Setting the Auxiliary Data Field Display

The XM Auxiliary Data Field (ADF) display can be switched on or off. There is no ADF function for the SIRIUS receiver.

- 1 Press and hold  (FUNCTION/SETUP) for at least 2 seconds to enter the Setup mode.**
- 2 Rotate the Double Action encoder to select the XM mode, and then press /ENTER.**
- 3 Press /ENTER to select "XM ADF".**
- 4 Rotate the Double Action encoder to select On/Off, and then press /ENTER.**
When setting to On, Auxiliary Data Field is displayed by pressing  VIEW (Refer to the "Changing the Display" section on page 31.)
- 5 Press and hold  for 2 seconds to return to normal mode.**

- Pressing  during the procedure will return to the previous mode.

IMPRINT Operation (Optional)

Alpine introduces IMPRINT - the world's first technology that thoroughly eliminates in-car acoustic problems that normally degrade sound quality, which enables us to experience music the way the artist intended.

When the IMPRINT audio processor (PXA-H100) (sold separately) is connected to this unit, MultEQ and the following sound adjustment can be performed.

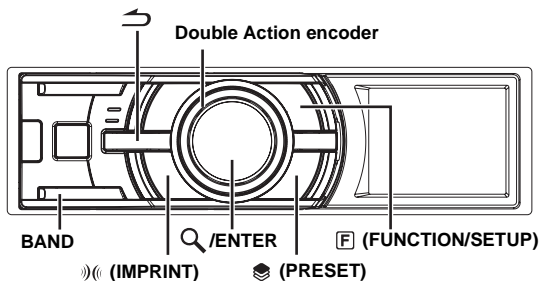

Changing MultEQ mode

MultEQ, developed by Audyssey Labs, automatically corrects the audio for the listening environment. The system is optimized for selected positions in the vehicle. To accomplish this, MultEQ must take measurements of the vehicle's response characteristics. For details on the set up procedure, consult your authorized Alpine dealer.

- 1 Press and hold **IMPRINT** for at least 2 seconds.
- 2 Press **Q/ENTER**.
- 3 Rotate the **Double Action encoder** to select the **MultEQ mode**, and then press **Q/ENTER**.
Curve 1 (MultEQ-1) ↔ Curve 2 (MultEQ-2) ↔ OFF (Manual Mode)
- 4 Press and hold **FUNCTION/SETUP** for at least 2 seconds to return to normal mode.

- The Curve mode can be selected only when curve 1 and curve 2 are stored.
- When MultEQ is set to ON, MX, Factory's EQ, Parametric EQ, Graphic EQ, X-Over, Time Correction, Subwoofer System, Tweeter, EQ Mode, Filter Type, Time Correction Parameter and MX Level Adjustment are set automatically. They are no longer user adjustable.

Adjusting Sound Setting in Manual Mode

The sound settings can be modified to create your own preference when the MultEQ mode is off (Manual Mode).

The changes made in manual mode can be stored into a preset. Refer to "Storing and Recalling the Adjusted Contents" (page 36).

Use steps 1 to 5 to select one of the Sound menu modes to modify. See the applicable section below for details about the selected item.

- 1 Press and hold **FUNCTION/SETUP** for at least 2 seconds to activate the **SETUP** selection mode.
- 2 Rotate the **Double Action encoder** to select "**Audio**", and then press **Q/ENTER**.
BLUETOOTH ↔ General ↔ Display ↔ iPod ↔ Tuner ↔ Audio
- 3 Rotate the **Double Action encoder** to select the **desired item**, and then press **Q/ENTER**.

User Preset/MX/Factory's EQ/Sound Field Adjustment^{*4}/ Subwoofer/Subwoofer System^{*1}/Subwoofer Phase^{*1}/ Subwoofer Channel^{*1}/Tweeter^{*2}/EQ Mode/Filter Type/ Time Correction Parameter/MX Level Adjustment^{*3} (e. g. Select MX)

^{*1} These functions are inoperable when Subwoofer is set to OFF.

^{*2} This function can be operable only when PXA-H100 (sold separately) is connected and X-OVER switch is set to 3WAY mode. For details, refer to the Owner's Manual of PXA-H100.

^{*3} This function is inoperable when MX is set to OFF.

^{*4} In step 3, three sound adjustment items (Parametric EQ/Graphic EQ, Time Correction, X-Over) can be selected in Sound Field Adjustment mode, rotate the **Double Action encoder** to select the desired item, and then press **Q/ENTER** to continue to step 4.

- 4 Rotate the **Double Action encoder** to change the **setting**, and then press **Q/ENTER**.
(e.g. Select MX On or MX Off)
- 5 Press and hold **FUNCTION/SETUP** for at least 2 seconds to return to normal mode.

- User Preset, Media Xpander, Factory's EQ, Parametric EQ/Graphic EQ Adjustment, EQ Mode and MX Level Adjustment are inoperable when Defeat is set to ON.
- Pressing **FUNCTION/SETUP** returns to the previous Sound menu mode.
- During setup, press in the outer ring and rotate the **Double Action encoder** to the left or right, the setting item selection screen changes page by page. If you press then rotate and hold the **Double Action encoder** to the left or right, the setting item selection screen continuously changes page by page.

Turning Media Xpander ON/OFF (MX)

On / Off (Initial setting)

When the Media Xpander is on, you can adjust the Media Xpander level (refer to page 33).

- The function is inoperable when Defeat is set to ON.

Setting the MX Level

MX (Media Xpander) makes vocals or instruments sound distinct regardless of the music source. The FM radio, CD, USB memory and iPod/iPhone, will be able to reproduce the music clearly even in cars with a lot of road noise.

Changing the source to which you want to apply Media Xpander.

FM (Level 1 to 3, Non Effect):

The medium to high frequencies become clearer, and produces well balanced sound at all frequencies.

CD (Level 1 to 3, Non Effect):

CD mode processes a large amount of data during playback. MX takes advantage of this large data quantity to reproduce a more clear, clean output.

MP3/WMA/AAC/iPod/BLUETOOTH Audio (Level 1 to 3, Non Effect):

This corrects information that was lost at the time of compression. This reproduces a well-balanced sound close to the original.

DVD (Video CD)

(Level 1 to 2 (MOVIE), Non Effect):

The dialogue portion of a video is reproduced more clearly.

(Level 3 (MUSIC), Non Effect):

A DVD or Video CD contains a large quantity of data such as music clip. MX uses this data to reproduce the sound accurately.

AUX (Level 1 (MP3/WMA/AAC/iPod/BLUETOOTH Audio), Level 2 (MOVIE), Level 3 (MUSIC), Non Effect):

Choose the MX mode that corresponds to the media connected. If two external devices are connected, a different MX mode for each media can be selected.

- To cancel MX mode for all music sources, set MX to Off in step 4.
- Each music source, such as FM radio, CD, and MP3/WMA/AAC can have its own MX setting.
- When the source changes from "MP3/WMA/AAC to CD-DA" or "CD-DA to MP3/WMA/AAC", MX-mode switching may delay playback slightly.
- Setting to MX Off sets MX mode of each music source to Off.
- There is no MX mode for AM radio.
- The function is inoperable when Defeat is set to ON.

Equalizer Presets (Factory's EQ)

Flat/Pops/Rock/News/Jazz&Blues/Electric Dance/Hip Hop & Rap/Easy Listening/Country/Classical/User 1~6*

10 typical equalizer settings are preset at the factory for a variety of musical source material.

* By selecting User's 1 to 6, you can recall the stored EQ Adjustment value in "Storing and Recalling the Adjusted Contents" (page 36).

- The function is inoperable when Defeat is set to ON.

Turning Subwoofer ON/OFF

Subwoofer On (Initial setting) / Subwoofer Off

If an optional subwoofer is connected to the unit, make the following setting.

When the subwoofer is on, you can adjust the subwoofer output level (refer to page 21).

Setting the Subwoofer System

Sys 1 (Initial setting) / Sys 2

When the subwoofer is on, you can select either Sys 1 or Sys 2 for the desired subwoofer effect.

- Sys 1 : Subwoofer level changes according to the main volume setting.
- Sys 2 : Subwoofer level change is different from the main volume setting. For example, even at low volume settings, the subwoofer is still audible.

Setting the Subwoofer Phase

Normal (Initial setting) / Reverse

The subwoofer output phase is toggled Subwoofer Normal (0°) or Subwoofer Reverse (180°).

Setting the Subwoofer Channel

Stereo (Initial setting) / Mono

You can set the subwoofer output to stereo or monaural. Make sure to set the correct output for your subwoofer type.

- Stereo : Subwoofer stereo (L/R) output
- Mono : Subwoofer monaural output

Setting the Response Slope for the High Range Speaker (Tweeter)

Maker's (Initial setting) / User's

Depending on the response characteristics of the speaker, care should be taken when setting the response slope of the high range speaker to 0 dB/oct in 3WAY mode (see "Adjusting the Crossover Settings" on page 35), as speaker damage may result.

- Maker's: As protection from possible speaker damage, 0 dB/oct cannot be set for the response slope of the high range speaker in 3WAY mode.
- User's: The 0 dB/oct setting is possible in 3WAY mode.

- You can set to Tweeter only when the system switch on the IMPRINT audio processor (PXA-H100) is set to 3WAY.

Setting EQ mode

Graphic / Parametric (Initial setting)

This setting gives you a choice of 5-band parametric, or 7-band graphic equalizer.

- The function is inoperable when Defeat is set to ON.

Setting the Filter type

Normal (Initial setting) / Individual

If you adjust X-OVER, you can set the channel L and R at the same level, or independently.

- Normal (L=R): Left and right speakers are adjusted equally.
- Individual (L/R): Left and right speakers are individually adjusted.

Setting the Time Correction Unit

cm (Initial setting) / inch

You can change the unit, (cm or inch) of time correction.

Sound Field Adjustment

The setting of Parametric EQ/Graphic EQ Adjustment, Time Correction and X-Over can be adjusted in this mode.

Adjusting the Parametric Equalizer Curve

Sound Field Adjustment → EQ Adjustment

You can modify the Equalizer settings to create a response curve more appealing to your personal taste. To adjust the Parametric Equalizer Curve, set the EQ mode to Parametric EQ. For details, refer to "Setting EQ mode" (page 33).

1 Rotate the Double Action encoder to select "EQ Adjustment" in the Sound Field adjustment mode, and then press Q/ENTER.

2 Rotate the Double Action encoder to select the Band, and then press Q/ENTER.

If a band is selected, each band adjustment screen is displayed.

Band1 / Band2 / Band3 / Band4 / Band5

3 Rotate the Double Action encoder to adjust the frequency/band width/level.

The item currently being adjusted lights up.

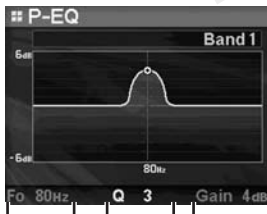

Frequency Bandwidth Level

4 If Q/ENTER is pressed, the adjusted value is set, and operation moves to the next item to be adjusted.

5 When the selected band settings are complete, press BAND.

The next band adjustment screen is displayed.

6 Repeat steps 3 to 5, and adjust each band.

Frequency Adjustment (Fo)

Adjustable frequency bands:
20 Hz to 20 kHz (in 1/3 octave steps)

- Band1: 20 Hz~80 Hz (63 Hz)
Band2: 50 Hz~200 Hz (150 Hz)
Band3: 125 Hz~3.2 kHz (400 Hz)
Band4: 315 Hz~8 kHz (1 kHz)
Band5: 800 Hz~20 kHz (2.5 kHz)

Bandwidth Adjustment (Q)

Adjustable bandwidth: 1, 1.5, 3

Level Adjustment (Gain)

Adjustable level: -6 to +6 dB

- The frequencies of adjacent bands cannot be adjusted within 4 steps.
- While adjusting the Parametric EQ, you should consider the frequency response of the connected speakers.
- During adjustment, if you press in the outer ring and rotate the **Double Action encoder** to the left or right, the band changes, and you can adjust the adjacent band. If you press then rotate and hold the **Double Action encoder** to the left or right, the band continuously changes.
- The function is inoperable when Defeat is set to ON.

Adjusting the Graphic Equalizer Curve

Sound Field Adjustment → EQ Adjustment

You can modify the equalizer settings to create a response curve more appealing to your personal taste. To adjust the graphic equalizer curve, set the EQ mode to Graphic EQ. For details, refer to "Setting EQ mode" (page 33).

1 Rotate the Double Action encoder to select "EQ Adjustment" in the Sound Field adjustment mode, and then press Q/ENTER.

2 Rotate the Double Action encoder to select the Band, and then press Q/ENTER.

If a band is selected, the screen to be adjusted is displayed.

Band1 / Band2 / Band3 / Band4 / Band5 / Band6 / Band7

3 Rotate the Double Action encoder to adjust the level, and then press Q/ENTER.

The level is selected, and the frequency selection mode is activated.

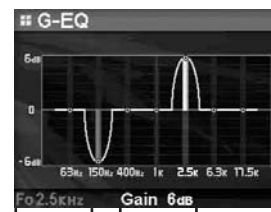

Frequency Level

4 Rotate the Double Action encoder to select the Frequency, and then press Q/ENTER.

The frequency is selected, and the level adjustment mode is activated. The selected frequency is displayed in yellow.

5 When the selected band settings are complete, press BAND.

The next band adjustment screen is displayed.

6 Repeat steps 3 to 5, and adjust each band level.

■ Frequency Adjustment (F0)

Band1 (63 Hz) / Band2 (150 Hz) / Band3 (400 Hz) /
Band4 (1 kHz) / Band5 (2.5 kHz) / Band6 (6.3 kHz) /
Band7 (17.5 kHz)

■ Level Adjustment (Gain)

Adjustable output level: -6 to +6 dB

- During adjustment, if you press in the outer ring and rotate the **Double Action encoder** to the left or right, the band changes, and you can adjust the adjacent band. If you press then rotate and hold the **Double Action encoder** to the left or right, the band continuously changes.
- The function is inoperable when *Defeat* is set to ON.

Adjusting the Time Correction

Sound Field Adjustment → Time Correction

Before performing the following procedures, refer to “About Time Correction” (page 37).

1 Rotate the **Double Action encoder** to select “Time Correction” in the Sound Field adjustment mode, and then press **Q/ENTER**.

Depending on the X-OVER switch setting on the IMPRINT audio processor (PXA-H100), the speaker to be adjusted differs.

3WAY System

High L / High R / Mid L / Mid R / Low L / Low R

F/R/SUBW. System

Front L / Front R / Rear L / Rear R / Subw. L / Subw. R

2 Rotate the **Double Action encoder** to select the speaker, and press **Q/ENTER**.



3 Rotate the **Double Action encoder** to set to the distance of each speaker.

0.0 cm~336.6 cm (0.0 inch~132.7 inch)

4 If **Q/ENTER** is pressed, the adjustment value is set, and the speaker selection mode is activated.

5 Repeat steps 2 to 4, and set the all speakers.

- During adjustment, if you press in the outer ring and rotate the **Double Action encoder** to the left or right, the speaker changes, and you can adjust the adjacent band. If you press then rotate and hold the **Double Action encoder** to the left or right, the speaker continuously changes.
You can also change the speaker by pressing **BAND**.

Adjusting the Crossover Settings

Sound Field Adjustment → X-Over

Before performing the following procedures, refer to “About the Crossover” (page 38).

1 Rotate the **Double Action encoder** to select “X-Over” in the Sound Field adjustment mode, and then press **Q/ENTER**.

2 Rotate the **Double Action encoder** to select the band, and then press **Q/ENTER**.

If a band is selected, each band screen to be adjusted is displayed.

3WAY System / Normal (L=R)

Setting items:

Low/Mid-Low/Mid-High/High

3WAY System / Individual (L/R)

Setting items:

Low L/Low R/Mid-Low L/Mid-Low R/Mid-High L/
Mid-High R/High L/High R

F/R/SUBW. System / Normal (L=R)

Setting items:

Subw./Rear/Front

F/R/SUBW. System / Individual (L/R)

Setting items:

Subw. L/Subw. R/Rear L/Rear R/Front L/Front R

- Depending on the current system, selectable band content differs. Refer to “Setting the Filter type” (page 34) and the setting of the X-OVER switch on the IMPRINT audio processor (PXA-H100).

3 Rotate the **Double Action encoder** to adjust the frequency/slope/level.

The currently adjusted item lights up.

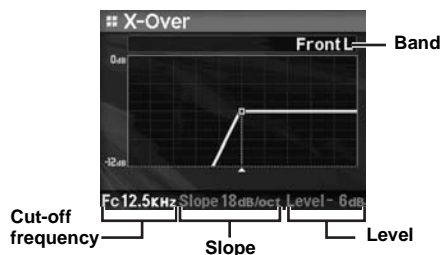

4 The adjustment content is selected by pressing **Q/ENTER**, and operation shifts to a next adjustment item.

5 When the selected band settings are complete, press **BAND**.

The next band adjustment screen is displayed.

6 Set all bands by repeating steps 3 to 5.

■ Cut-off frequency (Fc)

Adjustable frequency bands:

3WAY System

Setting items:

Low/Mid-Low L	20 Hz~200 Hz
Mid-High	20 Hz~20 kHz
High	(1 kHz~20 kHz)* ¹ /(20 Hz~20 kHz)* ²

*¹ When Maker's is selected. Refer to "Setting the Response Slope for the High Range Speaker (Tweeter)" (page 33).

*² When User's is selected. Refer to "Setting the Response Slope for the High Range Speaker (Tweeter)" (page 33).

F/R/SUBW. System

Setting items:

20 Hz~200 Hz

■ Slope Adjustment

Adjustable slope: 0/6/12/18/24 dB/oct

* 0 dB/oct can be set for the High slope only when User's is selected in "Setting the Response Slope for the High Range Speaker (Tweeter)" (page 33). Depending on the response characteristics of the speaker, care should be taken when setting the response slope to 0 dB/oct, as speaker damage may result. With this unit, a message is displayed when the response slope for the high range speaker is set to 0 dB/oct.

■ Level Adjustment

Adjustable output level: -12 to 0 dB.

- While adjusting the X-Over, you should consider the frequency response of the connected speakers.
- During adjustment, if you press in the outer ring and rotate the **Double Action encoder** to the left or right, the band changes, and you can adjust the adjacent band. If you press then rotate and hold the **Double Action encoder** to the left or right, the band continuously changes.
- **About the F/R/SUBW. / 3WAY system**
You can switch to F/R/SUBW. / 3WAY system mode with the X-OVER switch on the PXA-H100. For details, refer to the Owner's Manual of PXA-H100.

Storing and Recalling the Adjusted Contents

User 1 / User 2 / User 3 / User 4 / User 5 / User 6

The contents of all adjusted items (in manual mode) can be stored together into a preset. Up to 6 presets can be used.

■ Storing the Adjusted Contents

1 Rotate the Double Action encoder to select "User Preset", and then press Q/ENTER.

The User Preset screen is displayed.

2 Rotate the Double Action encoder to select a preset number, and then press and hold Q/ENTER for at least 2 seconds.

Adjusted/set contents are stored in the selected preset number.

■ Recall the adjusted contents

The stored contents can be recalled in "Storing the Adjusted Contents" (page 36).

1 Rotate the Double Action encoder to select "User Preset", and then press Q/ENTER.

The User Preset screen is displayed.

2 Rotate the Double Action encoder to select a preset number, and then press Q/ENTER.

Adjusted/set contents of the selected preset number are recalled.

- The User Preset screen can be recalled in the normal mode by pressing and holding **PRESET** for 2 seconds.
- The stored contents are not deleted even when resetting the unit or disconnecting the battery.
- The function is inoperable when Defeat is set to ON.

About Time Correction

The distance between the listener and the speakers in a car vary widely due to the complex speaker placement. This difference in the distances from the speakers to the listener creates a shift in the sounds image and frequency characteristics. This is caused by the time delay between the sound reaching the listener's right versus the left ear.

To correct this, this unit is able to delay the audio signal to the speakers closest to the listener. This effectively creates a perception of increased distance for those speakers. The listener can be placed at an equal distance between the left and right speakers for optimum staging. The adjustment will be made for each speaker in 3.4cm steps.

Example 1. Listening Position: Front Left Seat

Adjust the time correction level of the front left speaker to a high value and the rear right to a low value.

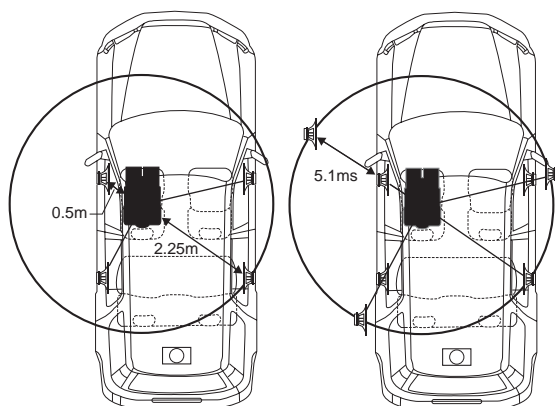

The sound is not balanced because the distance between the listening position and the various speakers is different. The difference in distance between the front left speaker and the rear right speaker is 1.75 m (68-7/8"). Here we calculate the time correction value for the front left speaker in the diagram on the above.

Conditions:

Farthest Speaker – listening position : 2.25 m (88-9/16")

Front left speaker – listening position : 0.5 m (19-11/16")

Calculation: $L = 2.25\text{ m} - 0.5\text{ m} = 1.75\text{ m}$ (68-7/8")

Time correction = $1.75 \div 343^{*1} \times 1000 = 5.1$ (ms)

**1 Speed of sound: 343 m/s (765 mph) at 20°C*

In other words, giving the front left speaker a time correction value of 5.1 ms makes it seem as if its distance from the listener is the same as the distance to the farthest speaker.

Time correction eliminates the differences in the time required for the sound to reach the listening position.

The time of the front left speaker is corrected by 5.1 ms so that its sound reaches the listening position at the same time as the sound of other speakers.

Example 2. Listening Position: All Seats

Adjust the time correction level of each speaker to almost the same level.

- 1** Sit in the listening position (driver's seat, etc.) and measure the distance (in meters) between your head and the various speakers.
- 2** Calculate the difference between the distance correction value to the farthest speaker and the other speakers.

$L = (\text{distance to farthest speaker}) - (\text{distance to other speakers})$

These values are the time correction values for the different speakers. Setting these values to make each sound reach the listening position at the same time as the sound of other speakers.

Time Correction Value List

Delay Number	Time Difference (ms)	Distance (cm)	Distance (inch)	Delay Number	Time Difference (ms)	Distance (cm)	Distance (inch)
0	0.0	0.0	0.0	51	5.1	173.4	68.3
1	0.1	3.4	1.3	52	5.2	176.8	69.7
2	0.2	6.8	2.7	53	5.3	180.2	71.0
3	0.3	10.2	4.0	54	5.4	183.6	72.4
4	0.4	13.6	5.4	55	5.5	187.0	73.7
5	0.5	17.0	6.7	56	5.6	190.4	75.0
6	0.6	20.4	8.0	57	5.7	193.8	76.4
7	0.7	23.8	9.4	58	5.8	197.2	77.7
8	0.8	27.2	10.7	59	5.9	200.6	79.1
9	0.9	30.6	12.1	60	6.0	204.0	80.4
10	1.0	34.0	13.4	61	6.1	207.4	81.7
11	1.1	37.4	14.7	62	6.2	210.8	83.1
12	1.2	40.8	16.1	63	6.3	214.2	84.4
13	1.3	44.2	17.4	64	6.4	217.6	85.8
14	1.4	47.6	18.8	65	6.5	221.0	87.1
15	1.5	51.0	20.1	66	6.6	224.4	88.4
16	1.6	54.4	21.4	67	6.7	227.8	89.8
17	1.7	57.8	22.8	68	6.8	231.2	91.1
18	1.8	61.2	24.1	69	6.9	234.6	92.5
19	1.9	64.6	25.5	70	7.0	238.0	93.8
20	2.0	68.0	26.8	71	7.1	241.4	95.1
21	2.1	71.4	28.1	72	7.2	244.8	96.5
22	2.2	74.8	29.5	73	7.3	248.2	97.8
23	2.3	78.2	30.8	74	7.4	251.6	99.2
24	2.4	81.6	32.2	75	7.5	255.0	100.5
25	2.5	85.0	33.5	76	7.6	258.4	101.8
26	2.6	88.4	34.8	77	7.7	261.8	103.2
27	2.7	91.8	36.2	78	7.8	265.2	104.5
28	2.8	95.2	37.5	79	7.9	268.6	105.9
29	2.9	98.6	38.9	80	8.0	272.0	107.2
30	3.0	102.0	40.2	81	8.1	275.4	108.5
31	3.1	105.4	41.5	82	8.2	278.8	109.9
32	3.2	108.8	42.9	83	8.3	282.2	111.2
33	3.3	112.2	44.2	84	8.4	285.6	112.6
34	3.4	115.6	45.6	85	8.5	289.0	113.9
35	3.5	119.0	46.9	86	8.6	292.4	115.2
36	3.6	122.4	48.2	87	8.7	295.8	116.6
37	3.7	125.8	49.6	88	8.8	299.2	117.9
38	3.8	129.2	50.9	89	8.9	302.6	119.3
39	3.9	132.6	52.3	90	9.0	306.0	120.6
40	4.0	136.0	53.6	91	9.1	309.4	121.9
41	4.1	139.4	54.9	92	9.2	312.8	123.3
42	4.2	142.8	56.3	93	9.3	316.2	124.6
43	4.3	146.2	57.6	94	9.4	319.6	126.0
44	4.4	149.6	59.0	95	9.5	323.0	127.3
45	4.5	153.0	60.3	96	9.6	326.4	128.6
46	4.6	156.4	61.6	97	9.7	329.8	130.0
47	4.7	159.8	63.0	98	9.8	333.2	131.3
48	4.8	163.2	64.3	99	9.9	336.6	132.7
49	4.9	166.6	65.7				
50	5.0	170.0	67.0				

About the Crossover

Crossover (X-OVER):

This unit is equipped with an active crossover. The crossover limits the frequencies delivered to the outputs. Each channel is controlled independently. Thus, each speaker pair can be driven by the frequencies for which they have been optimally designed.

The crossover adjusts the HPF (high pass filter) or LPF (low pass filter) of each band, and also the slope (how fast the filter rolls off the highs or lows).

Adjustments should be made according to the reproduction characteristics of the speakers. Depending on the speakers, a passive network may not be necessary. If you are unsure about this point, please consult your authorized Alpine dealer.

F/R/SUBW. Mode

	Cut-off frequency (1/3 octave steps)		Slope		Level
	HPF	LPF	HPF	LPF	
Low range speaker	----	20 Hz - 200 Hz	----	FLAT, 6, 12, 18, 24 dB/oct.	0 to -12 dB
Rear high range speaker	20 Hz - 200 Hz	----	FLAT, 6, 12, 18, 24 dB/oct.	----	0 to -12 dB
Front high range speaker	20 Hz - 200 Hz	----	FLAT, 6, 12, 18, 24 dB/oct.	----	0 to -12 dB

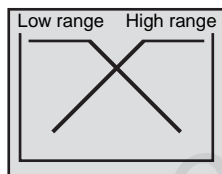

(Different from actual display)

3WAY Mode

	Cut-off frequency (1/3 octave steps)		Slope		Level
	HPF	LPF	HPF	LPF	
Low range speaker	----	20 Hz - 200 Hz	----	FLAT, 6, 12, 18, 24 dB/oct.	0 to -12 dB
Mid range speaker	20 Hz - 200 Hz	20 Hz - 20 kHz	FLAT, 6, 12, 18, 24 dB/oct.	FLAT, 6, 12, 18, 24 dB/oct.	0 to -12 dB
High range speaker	1 kHz - 20 kHz, (20 Hz ~ 20 kHz)*	----	FLAT* 6, 12, 18, 24 dB/oct.	----	0 to -12 dB

* Only when selecting User's in "Setting the Response Slope for the High Range Speaker (Tweeter)" (page 33).

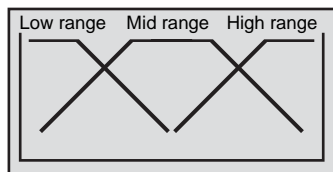

(Different from actual display)

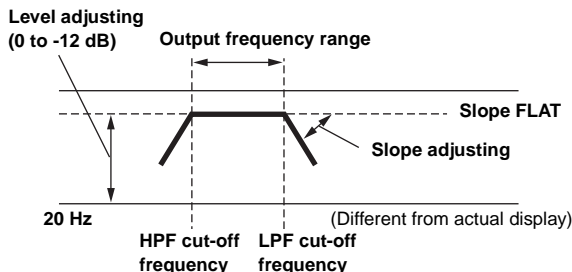

- **HPF (high pass filter):** Cuts the lower frequencies and allows the higher frequencies to pass.
 - **LPF (low pass filter):** Cuts the higher frequencies and allows the lower frequencies to pass.
 - **Slope:** The level change (in dB) for a frequency change of one octave.
 - The higher the slope value, the steeper the slope becomes.
 - Adjust the slope to FLAT (0 dB/oct) to bypass the HP or LP filters.
 - Do not use a tweeter without the HPF on or set to a low frequency, as it may cause damage to the speaker due to the low frequency content.
 - You cannot adjust the crossover frequency higher than the HPF or lower than the LPF.
 - Adjustment should be made according to the recommended crossover frequency of the connected speakers. Determine the recommended crossover frequency of the speakers. Adjusting to a frequency range outside that recommended may cause damage to the speakers. For the recommended crossover frequencies of Alpine speakers, refer to the respective Owner's Manual.
- We are not responsible for damage or malfunction of speakers caused by using the crossover outside the recommended value.

Information

In Case of Difficulty

If you encounter a problem, please turn the power off, then on again. If the unit is still not functioning normally, please review the items in the following checklist. This guide will help you isolate the problem if the unit is at fault. Otherwise, make sure the rest of your system is properly connected or consult your authorized Alpine dealer.

Basic

No function or display.

- Vehicle's ignition is off.
 - If connected following instructions, the unit will not operate with the vehicle's ignition off.
- Improper power lead (Red) and battery lead (Yellow) connections.
 - Check power lead and battery lead connections.
- Blown fuse.
 - Check the fuse of the unit; replace with the proper value if necessary.
- Internal micro-computer malfunctioned due to interference noise etc.
 - Press the RESET switch with a ball-point pen or other pointed article.

Radio

Unable to receive stations.

- No antenna or open connection in cable.
 - Make sure the antenna is properly connected; replace the antenna or cable if necessary.

Unable to tune stations in the seek mode.

- You are in a weak signal area.
 - Make sure the tuner is in the DX mode.
- If the area you are in is a primary signal area, the antenna may not be grounded and connected properly.
 - Check your antenna connections; make sure the antenna is properly grounded at its mounting location.
- The antenna may not be the proper length.
 - Make sure the antenna is fully extended; if broken, replace the antenna with a new one.

Broadcast is noisy.

- The antenna is not the proper length.
 - Extend the antenna fully; replace it if it is broken.
- The antenna is poorly grounded.
 - Make sure the antenna is grounded properly at its mounting location.

MP3/WMA/AAC

MP3, WMA or AAC is not played back.

- Writing error occurred. The MP3/WMA/AAC format is not compatible.
 - Make sure the MP3/WMA/AAC has been written in a supported format. Refer to ("About MP3/WMA/AAC" (pages 19-20), then rewrite in the format supported by this device.

Audio

The sound is not output from the speakers.

- Unit has no output signal of the internal amplifier.
 - Power IC is switched to "On" (page 25).

iPod/iPhone

iPod/iPhone does not play and no sound is output.

- The iPod/iPhone has not been recognized.
 - Reset this unit and the iPod/iPhone. Refer to "Initial System Start-Up" (page 7). To reset the iPod/iPhone, refer to the Owner's Manual of the iPod/iPhone.

Indication for iPod/iPhone Mode

Current Error

- Abnormal current is run to the USB connector device (an error message may be displayed if the USB device that is not compatible with the unit is connected).
 - Attempt to connect another iPod/iPhone.

USB Device Error

- An iPod/iPhone that is not supported by the unit is connected.
 - Connect an iPod/iPhone that is supported by the unit.
 - Reset the iPod/iPhone.

No USB Device

- An iPod/iPhone is not connected.
 - Make sure the iPod/iPhone is correctly connected and the cable is not excessively bent.

No Song

- There are no songs in the iPod/iPhone.
 - Download songs to the iPod/iPhone and connect to this unit.

No Support

- Text information that is not supported on the unit has been input.
 - Use an iPod/iPhone in which text information is input that is supported on the unit.

Error 01

- Communication error
 - Turn the ignition key off, and then set to ON again.
 - Verify in the display after reconnecting the iPod/iPhone to the iPod Dock interface cable and to the USB cable.
 - Reset the iPod/iPhone.

Error 02

- Caused by the iPod/iPhone Software Version not being compatible with this unit.
 - Update the iPod/iPhone Software Version to be compatible with this unit.

Error 03

- The iPod/iPhone is not verified.
 - Reset the iPod/iPhone.
 - Try another iPod/iPhone.
-

No Stations

(Pandora Radio mode)

- You have not created any personalized Pandora Stations.
 - When you are not driving, use the Pandora Compatible Application for iPhone to create your Pandora station(s).
-

When not driving please see mobile device

(Pandora Radio mode)

- The music cannot be played because the Pandora Compatible Application for iPhone requires the user's attention.
 - When you are not driving, please see the Pandora Compatible Application for iPhone.
-

Indication for USB memory

Current Error

- Abnormal current is run to the USB connector device (an error message may be displayed if the USB device that is not compatible with the unit is connected).
USB memory is a malfunction or it is shorted.
 - Connect another USB memory.
-

USB Device Error

- A USB device that is not supported by the unit is connected.
 - Connect a USB device that is supported by the unit.
-

No USB Device

- A USB memory is not connected.
 - Make sure the USB memory device is correctly connected and the cable is not excessively bent.
-

No Song

- No song (file) is stored in the USB memory.
 - Connect the USB memory device after storing songs (files).
-

Unsupported

- A sampling rate/bit rate not supported by the unit is used.
 - Use a sampling rate/bit rate that is supported by the unit.
-

Protect

- A copy-protected WMA file was played back.
 - You can only play back non-copy-protected files.
-

No Support

- Text information that is not recognizable by the unit has been input.
 - Use a USB memory device with input text information that is supported by the unit.
-

Indication for Portable audio player Mode

Current Error

- Abnormal current is run to the USB connector device (an error message may be displayed if the USB device that is not compatible with the unit is connected).
 - Attempt to connect another Portable audio player.
-

USB Device Error

- A Portable audio player that is not supported by the unit is connected.
 - Attempt to connect another Portable audio player.
-

No USB Device

- A Portable audio player is not connected.
 - Make sure the Portable audio player is correctly connected and the cable is not excessively bent.
-

No Song

- There are no songs in the Portable audio player.
 - Download songs to the Portable audio player and connect to this unit.
-

No Support

- Text information that is no supported on the unit has been input.
 - Use an Portable audio player in which text information is input that is supported on the unit.
-

Unsupported

- A sampling rate/bit rate not supported by the unit is used.
 - Use a sampling rate/bit rate that is supported by the unit.
-

Protect

- A copy-protected WMA file was played back.
 - You can only play back non-copy-protected files.
 - Make sure the Portable audio player is set to MTP.
-

Error 01

- Communication error
 - Turn the ignition key off, and then set to ON again.
 - Verify in the display after reconnecting the Portable audio player to the connection cable.
-

Error 02

- Caused by the Software Version not being compatible with this unit.
 - Update the Portable audio player Software Version. For details, refer to the Owner's Manual of player.
 - Reset the Portable audio player.

Indication for CD Changer

High Temperature

- Protective circuit is activated due to high temperature.
 - The indication will disappear when the temperature returns to normal operating range.

Error 01

- Malfunction in the CD Changer.
 - Consult your Alpine dealer. Press the magazine eject button and pull out the magazine. Check the indication. Insert the magazine again. If the magazine cannot be pulled out, consult your Alpine dealer.
- Magazine ejection not possible.
 - Press the magazine eject button. If the magazine does not eject, consult your Alpine dealer.

Error 02

- A disc is left inside the CD Changer.
 - Press the eject button to activate the eject function. When the CD Changer finishes the eject function, insert an empty CD magazine into the CD Changer to receive the disc left inside the CD Changer.

No Magazine

- No magazine is loaded into the CD Changer.
 - Insert a magazine.

No Disc

- No indicated disc.
 - Choose another disc.

Indication for SAT Receiver Mode

Check Antenna

(XM mode)

Antenna Error

(SIRIUS mode)

- The XM or SIRIUS antenna is not connected to the XM or SIRIUS radio module.
 - Check whether the XM or SIRIUS antenna cable is attached securely to the XM or SIRIUS radio module.

Updating

(SIRIUS mode)

- Radio is being updated with latest encryption code.
 - Wait until encryption code is being updated. Channels 0 and 1 should function normally.

No Signal

(XM mode)

Acquiring Signal

(SIRIUS mode)

- XM or SIRIUS signal is too weak at the current location.
 - Wait until the car reaches a location with a stronger signal.

Loading

- Radio is acquiring audio or program information.
 - Wait until the radio has received the information.

Channel Off Air

(XM mode)

Acquiring Signal

(SIRIUS mode)

- The channel currently selected has stopped broadcasting.
 - Select another channel.

Chan Unavailable

(XM mode)

Invalid Channel

(SIRIUS mode)

- The user has selected a channel number that is not available.
 - The unit will revert back to the previously selected channel.

Ch Unauthorized

(XM mode)

Call Sirius ... 1-888-539-SIRIUS

(SIRIUS mode)

- The user has selected a channel number that is not subscribed to.
 - The unit will revert back to the previously selected channel.

Error

- If an error or other problem occurs.
 - Change channels or consult your Alpine dealer.

Specifications

FM TUNER SECTION

Tuning Range	87.7-107.9 MHz
Mono Usable Sensitivity	9.3 dBf (0.8 μ V/75 ohms)
50 dB Quieting Sensitivity	13.5 dBf (1.3 μ V/75 ohms)
Alternate Channel Selectivity	80 dB
Signal-to-Noise Ratio	65 dB
Stereo Separation	35 dB
Capture Ratio	2.0 dB

AM TUNER SECTION

Tuning Range	530-1,710 kHz
Sensitivity (IEC Standard)	22.5 μ V/27 dB

USB SECTION

USB requirements	USB 1.1/2.0
Max. Power Consumption	500mA
File System	FAT12/16/32
MP3 Decoding	MPEG-1/2 AUDIO Layer-3
WMA Decoding	Windows Media™ Audio (WMDRM10 is supported)
AAC Decoding	AAC-LC format “.m4a” file
Number of Channels	2-Channel (Stereo)
Frequency Response*	5-20,000 Hz (\pm 1 dB)
Total Harmonic Distortion	0.008% (at 1 kHz)
Dynamic Range	95 dB (at 1 kHz)
Signal-to-Noise Ratio	105 dB
Channel Separation	85 dB (at 1 kHz)

* Frequency response may differ depending on the encoder software/bit rate.

GENERAL

Power Requirement	14.4 V DC (11-16 V allowable)
Power Output	18 W RMS \times 4*
*Primary amplifier ratings per CEA-2006 Standard	
• Power output: measured at 4 Ohms and \leq 1% THD+N	
• S/N: 80 dBA (reference: 1 W into 4 Ohms)	
Maximum Pre-Output Voltage	2 V/10 k ohms
Weight	1.0 kg (2 lbs. 3 oz)

CHASSIS SIZE

Width	178 mm (7")
Height	50 mm (2")
Depth	156 mm (6-1/8")

NOSEPIECE SIZE

Width	170 mm (6-3/4")
Height	46 mm (1-13/16")
Depth	28 mm (1-1/8")

DETACHABLE FRONT PANEL SIZE

Width	108 mm (4-1/4")
Height	46 mm (1-13/16")
Depth	36 mm (1-7/16")

- Due to continuous product improvement, specifications and design are subject to change without notice.

- Windows Media and the Windows logo are trademarks, or registered trademarks of Microsoft Corporation in the United States and/or other countries.
- iPod and iTunes are trademarks of Apple Inc., registered in the U.S. and other countries.
- iPhone is a trademark of Apple Inc., registered in the U.S. and other countries.
- “Made for iPod” means that an electronic accessory has been designed to connect specifically to iPod and has been certified by the developer to meet Apple performance standards.
- “Works with iPhone” means that an electronic accessory has been designed to connect specifically to iPhone and has been certified by the developer to meet Apple performance standards.
- Apple is not responsible for the operation of this device or its compliance with safety and regulatory standards.
- Audyssey MultEQ XT is a registered trademark of Audyssey Laboratories Inc.
- The BLUETOOTH® word mark and logos are registered trademarks owned by the Bluetooth SIG, Inc. and any use of such marks by Alpine Electronics, Inc. is under license.
- Pandora and the Pandora logo are registered trademarks of Pandora Media, Inc. All rights reserved.
- Due to music licensing restrictions, the Pandora radio service is only available in the United States.
- XM and its corresponding logos are trademarks of XM Satellite Radio Inc.
- SIRIUS and its corresponding logos are trademarks of SIRIUS Satellite Radio Inc.
- HD Radio™ and the HD and HD Radio Ready logos are proprietary trademarks of iBiquity Digital Corp.
- “MPEG Layer-3 audio coding technology licensed from Fraunhofer IIS and Thomson.”
- “Supply of this product only conveys a license for private, non-commercial use and does not convey a license nor imply any right to use this product in any commercial (i.e. revenue-generation) real time broadcasting (terrestrial, satellite, cable and/or any other media), broadcasting/streaming via internet, intranets and/or other networks or in other electronic content distribution systems, such as pay-audio or audio-on-demand applications. An independent license for such use is required. For details, please visit <http://www.mp3licensing.com>”
- “Uni-Type™” is a style of Universal design font developed by a joint research between LIM Corporation Ltd., and Chiba University Faculty of Engineering.
- “Uni-Type™” is the trademark registered by LIM Corporation Ltd.

Installation and Connections

Before installing or connecting the unit, please read the following and pages 4 and 5 of this manual thoroughly for proper use.

Warning

MAKE THE CORRECT CONNECTIONS.

Failure to make the proper connections may result in fire or product damage.

USE ONLY IN CARS WITH A 12 VOLT NEGATIVE GROUND.

(Check with your dealer if you are not sure.) Failure to do so may result in fire, etc.

BEFORE WIRING, DISCONNECT THE CABLE FROM THE NEGATIVE BATTERY TERMINAL.

Failure to do so may result in electric shock or injury due to electrical shorts.

DO NOT SPLICE INTO ELECTRICAL CABLES.

Never cut away cable insulation to supply power to other equipment. Doing so will exceed the current carrying capacity of the wire and result in fire or electric shock.

DO NOT DAMAGE PIPE OR WIRING WHEN DRILLING HOLES.

When drilling holes in the chassis for installation, take precautions so as not to contact, damage or obstruct pipes, fuel lines, tanks or electrical wiring. Failure to take such precautions may result in fire.

DO NOT USE BOLTS OR NUTS IN THE BRAKE OR STEERING SYSTEMS TO MAKE GROUND CONNECTIONS.

Bolts or nuts used for the brake or steering systems (or any other safety-related system), or tanks should NEVER be used for installations or ground connections. Using such parts could disable control of the vehicle and cause fire etc.

KEEP SMALL OBJECTS SUCH AS BOLTS OR SCREWS OUT OF THE REACH OF CHILDREN.

Swallowing them may result in serious injury. If swallowed, consult a physician immediately.

DO NOT INSTALL IN LOCATIONS WHICH MIGHT HINDER VEHICLE OPERATION, SUCH AS THE STEERING WHEEL OR GEARSHIFT.

Doing so may obstruct forward vision or hamper movement etc. and results in serious accident.

DO NOT ALLOW CABLES TO BECOME ENTANGLED IN SURROUNDING OBJECTS.

Arrange wiring and cables in compliance with the manual to prevent obstructions when driving. Cables or wiring that obstruct or hang up on places such as the steering wheel, gear lever, brake pedals, etc. can be extremely hazardous.

Caution

HAVE THE WIRING AND INSTALLATION DONE BY EXPERTS.

The wiring and installation of this unit requires special technical skill and experience. To ensure safety, always contact the dealer where you purchased this product to have the work done.

USE SPECIFIED ACCESSORY PARTS AND INSTALL THEM SECURELY.

Be sure to use only the specified accessory parts. Use of other than designated parts may damage this unit internally or may not securely install the unit in place. This may cause parts to become loose resulting in hazards or product failure.

ARRANGE THE WIRING SO IT IS NOT CRIMPED OR PINCHED BY A SHARP METAL EDGE.

Route the cables and wiring away from moving parts (like the seat rails) or sharp or pointed edges. This will prevent crimping and damage to the wiring. If wiring passes through a hole in metal, use a rubber grommet to prevent the wire's insulation from being cut by the metal edge of the hole.

DO NOT INSTALL IN LOCATIONS WITH HIGH MOISTURE OR DUST.

Avoid installing the unit in locations with high incidence of moisture or dust. Moisture or dust that penetrates into this unit may result in product failure.

Precautions

- Be sure to disconnect the cable from the (-) battery post before installing your iDA-X305S. This will reduce any chance of damage to the unit in case of a short-circuit.
- Be sure to connect the color coded leads according to the diagram. Incorrect connections may cause the unit to malfunction or damage to the vehicle's electrical system.
- When making connections to the vehicle's electrical system, be aware of the factory installed components (e.g. on-board computer). Do not tap into these leads to provide power for this unit. When connecting the iDA-X305S to the fuse box, make sure the fuse for the intended circuit of the iDA-X305S has the appropriate amperage. Failure to do so may result in damage to the unit and/or the vehicle. When in doubt, consult your Alpine dealer.
- The iDA-X305S uses female RCA-type jacks for connection to other units (e.g. amplifier) having RCA connectors. You may need an adaptor to connect other units. If so, please contact your authorized Alpine dealer for assistance.
- Be sure to connect the speaker (-) leads to the speaker (-) terminal. Never connect left and right channel speaker cables to each other or to the vehicle body.

IMPORTANT

Please record the serial number of your unit in the space provided below and keep it as a permanent record. The serial number or the engraved serial number is located on the bottom of the unit.

SERIAL NUMBER: _____

INSTALLATION DATE: _____

INSTALLATION TECHNICIAN: _____

PLACE OF PURCHASE: _____

Installation

Caution

Do not block the unit's heat sink, thus preventing air circulation. If blocked, heat will accumulate inside the unit and may cause a fire.

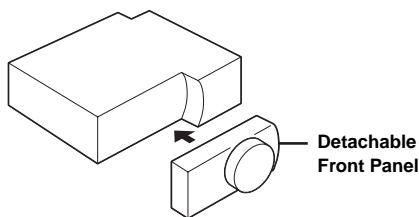
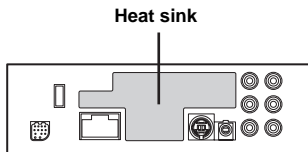

Caution

When you install this unit in your car, do not remove the detachable front panel. If the detachable front panel is removed during installation, you might press too hard and warp the metal plate that holds it in place.

- The main unit must be mounted within 35 degrees of the horizontal plane, back to front.

Less than 35°

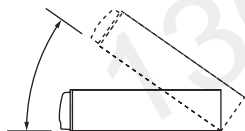

1

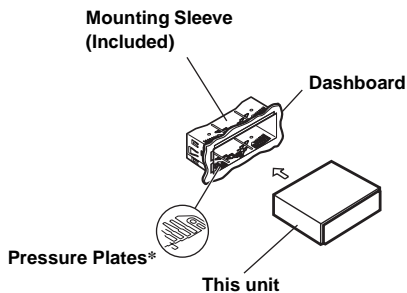

* If the installed mounting sleeve is loose in the main unit, the pressure plates may be widened slightly to remedy the problem.

Remove mounting sleeve from the main unit (see "Removal" on page 44).

2

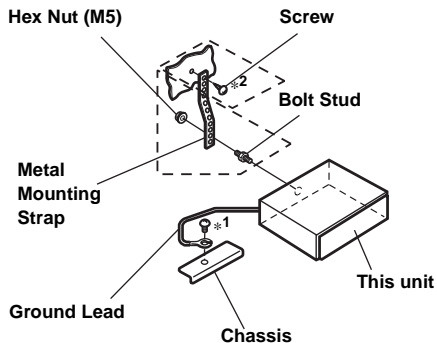

Reinforce the head unit with the metal mounting strap (not supplied). Secure the ground lead of the unit to a clean metal spot using a screw (*¹) already attached to the vehicle's chassis.

- For the screw marked "^{*}2", use an appropriate screw for the chosen mounting location.

Connect each input lead coming from an amplifier or equalizer to the corresponding output lead coming from the left rear of the iDA-X305S. Connect all other leads of the iDA-X305S according to details described in the CONNECTIONS section.

3

Slide the iDA-X305S into the dashboard until it clicks. This ensures that the unit is properly locked and will not accidentally come out from the dashboard. Install the detachable front panel.

Removal

- Remove the detachable front panel.
- Insert the bracket keys into the unit, along the guides on either side. The unit can now be removed from the mounting sleeve.

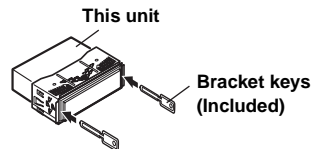

- Pull the unit out, keeping it unlocked as you do so.

<JAPANESE CAR>

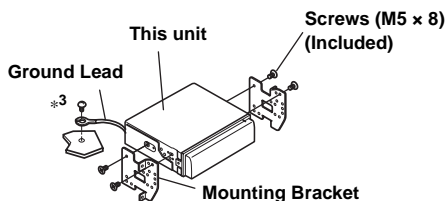
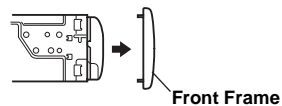

- Secure the ground lead of the unit to a clean metal spot using a screw (*³) already attached to the vehicle's chassis.

USB cable connection

Insert a USB cable into the unit, and fix with a lock screw.

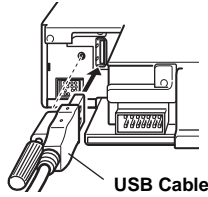

iPod/iPhone Connection (sold separately)

Connect USB cable to an iPod/iPhone with iPod Dock interface cable.

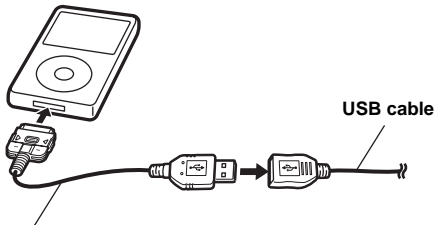

Remove the iPod/iPhone

Remove the iPod/iPhone from the iPod Dock interface cable.

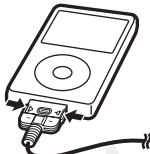

- After changing the unit to a source other than the iPod, remove the iPod/iPhone. If the iPod/iPhone is removed in the iPod mode, data may cause damage.
- If sound is not output or the iPod/iPhone is not recognized even when the iPod/iPhone is connected, remove the iPod/iPhone once, then connect it again, or reset the iPod/iPhone.
- Before connecting the iPod/iPhone to this unit, set the EQ function of iPod/iPhone to OFF.
- Do not leave the iPod/iPhone in a vehicle for a long time. Heat and humidity may damage the iPod/iPhone and you may not be able to play it again.

USB memory Connection (sold separately)

Connect USB memory

Connect USB memory to USB cable.

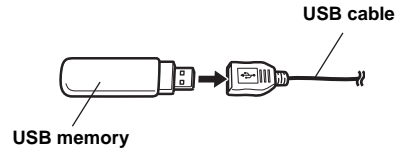

Remove USB memory

Pull out USB memory squarely from the USB cable.

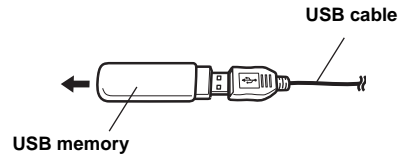

- When removing USB memory, pull it out straight.
- If sound is not output or USB memory is not recognized even when USB memory is connected, remove USB memory once, then connect it again.
- Change to a source other than the USB memory mode, then remove the USB memory. If the USB memory is removed in the USB memory mode, data may be damaged.

Portable Audio Player Connection (sold separately)

Connect Portable audio player

Connect the cable supplied with a Portable audio player to the USB cable.

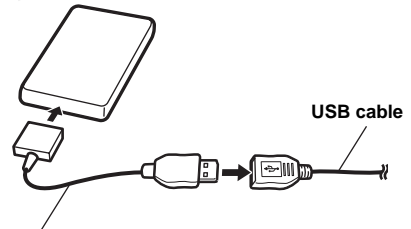

Remove Portable audio player

Disconnect the Portable audio player from the supplied player cable.

- Refer also to the Owner's Manual of the Portable audio player.

Connections

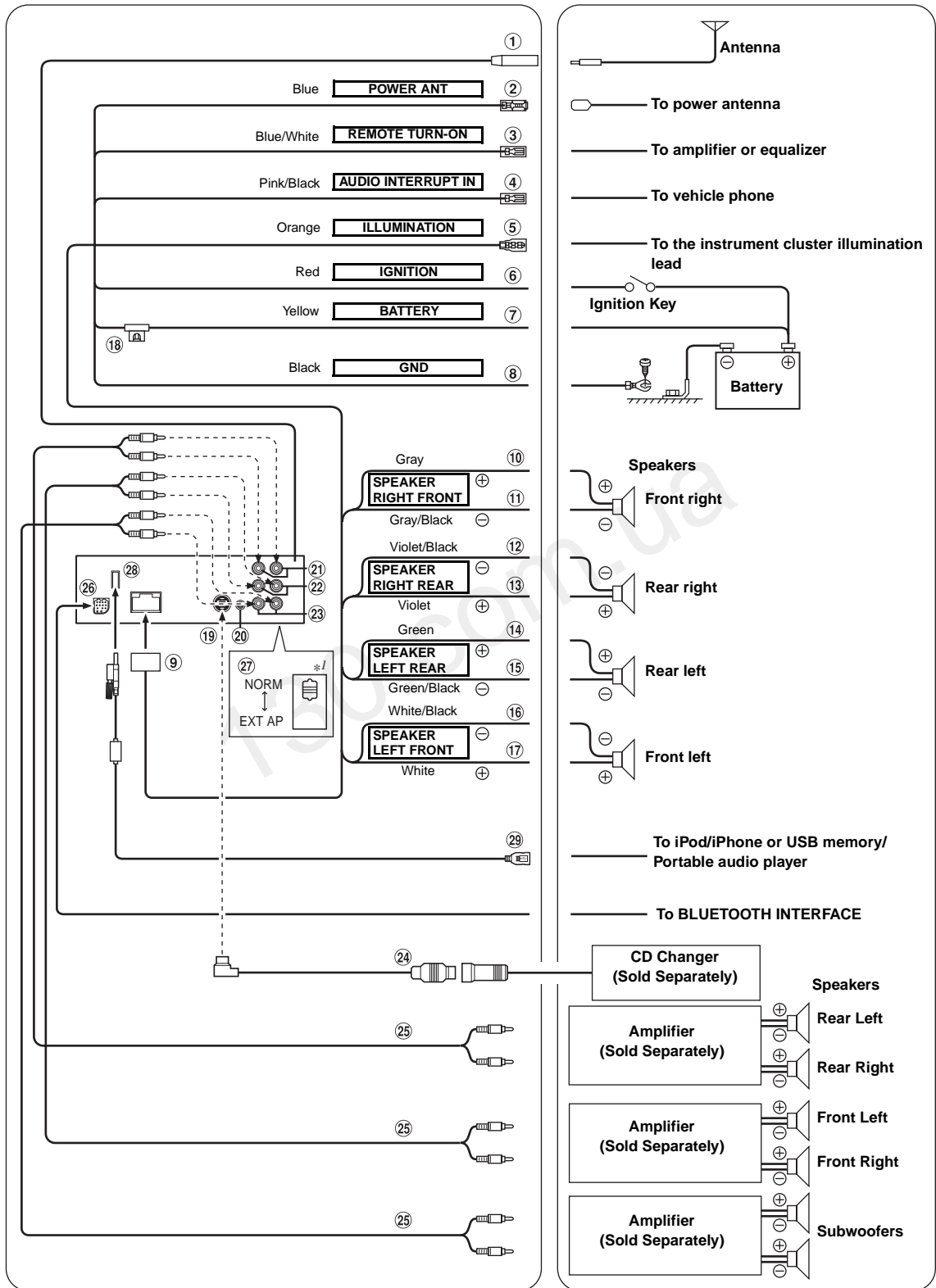

*1 The system switch is located on the bottom of the unit.

- ① **Antenna Receptacle**
- ② **Power Antenna Lead (Blue)**
Connect this lead to the +B terminal of your power antenna, if applicable.
 - *This lead should be used only for controlling the vehicle's power antenna. Do not use this lead to turn on an amplifier, or a signal processor, etc.*
- ③ **Remote Turn-On Lead (Blue/White)**
Connect this lead to the remote turn-on lead of your amplifier or signal processor.
- ④ **Audio Interrupt In Lead (Pink/Black)**
- ⑤ **Illumination Lead (Orange)**
This lead may be connected to the vehicle's instrument cluster illumination lead. This will allow the backlighting of the iDA-X305S to dim whenever the vehicle's lights are turned on.
- ⑥ **Switched Power Lead (Ignition) (Red)**
Connect this lead to an open terminal on the vehicle's fuse box or another unused power source which provides (+)12V only when the ignition is turned on or in the accessory position.
- ⑦ **Battery Lead (Yellow)**
Connect this lead to the positive (+) post of the vehicle's battery.
- ⑧ **Ground Lead (Black)**
Connect this lead to a good chassis ground on the vehicle. Make sure the connection is made to bare metal and is securely fastened using the sheet metal screw provided.
- ⑨ **Power Supply Connector**
- ⑩ **Right Front (+) Speaker Output Lead (Gray)**
- ⑪ **Right Front (-) Speaker Output Lead (Gray/Black)**
- ⑫ **Right Rear (-) Speaker Output Lead (Violet/Black)**
- ⑬ **Right Rear (+) Speaker Output Lead (Violet)**
- ⑭ **Left Rear (+) Speaker Output Lead (Green)**
- ⑮ **Left Rear (-) Speaker Output Lead (Green/Black)**
- ⑯ **Left Front (-) Speaker Output Lead (White/Black)**
- ⑰ **Left Front (+) Speaker Output Lead (White)**
- ⑱ **Fuse Holder (10A)**
- ⑲ **Ai-NET Connector**
Connect this to the output or input connector of another device (CD Changer, Equalizer, HD Radio™ TUNER MODULE, etc.) equipped with Ai-NET.
 - *Be sure to set "Setting the Connected Head Unit (MODEL SETUP)" to "DVD CHG", when the DHA-S690 is connected.*
 - *Interface adapter for iPod (KCA-420i) is not recommended for use with this product.*
- ⑳ **Steering Remote Control Interface Connector**
To steering Remote control interface box.
For details about connections, consult your nearest Alpine dealer.
- ㉑ **Rear Output/Input RCA Connectors**
It can be used as Rear Output or Input RCA Connectors. RED is right and WHITE is left.
- ㉒ **Front Output/Input RCA Connectors**
It can be used as Front Output or Input RCA Connectors. RED is right and WHITE is left.
- ㉓ **Subwoofer RCA Connectors**
RED is right and WHITE is left.
- ㉔ **Ai-NET Cable (Included with CD Changer)**
- ㉕ **RCA Extension Cable (sold separately)**
- ㉖ **BLUETOOTH Interface Connector**
Connect this to an optional BLUETOOTH INTERFACE (KCE-400BT).
To use a hands-free mobile phone, an optional BLUETOOTH INTERFACE connection is required. For details on connection, refer to the Owner's Manual of the BLUETOOTH INTERFACE. You can input the audio of an external device, (such as a Portable audio player) to the BLUETOOTH interface connector of this unit. A special Conversion cable (KCE-237B) is necessary to adapt the BLUETOOTH interface connector as an AUX IN.
- ㉗ **System Switch**
When connecting a processor or divider using Ai-NET, place this switch in the EXT AP position. When no device is connected, leave the switch in the NORM position.
 - *When the IMPRINT audio processor is connected, set to EXT AP position.*
 - *Be sure to turn the power off to the unit before changing the switch position.*
- ㉘ **USB Connector**
Connect USB cable.
- ㉙ **USB cable**
Connect this to a USB memory/Portable audio player or to an iPod/iPhone. To use an iPod/iPhone, iPod Dock interface cable connection is required.
 - *Use the supplied USB cable. If a USB cable other than the supplied is used, correct performance cannot be guaranteed.*
 - *Route the USB cable away from other cables.*

To prevent external noise from entering the audio system.

- Locate the unit and route the leads at least 10 cm away from the car harness.
- Keep the battery power leads as far away from other leads as possible.
- Connect the ground lead securely to a bare metal spot (remove any paint, dirt or grease if necessary) of the car chassis.
- If you add an optional noise suppressor, connect it as far away from the unit as possible. Your Alpine dealer carries various noise suppressors, contact them for further information.
- Your Alpine dealer knows best about noise prevention measures so consult your dealer for further information.



LIMITED WARRANTY

ALPINE ELECTRONICS OF AMERICA, INC. AND ALPINE OF CANADA INC. ("Alpine"), are dedicated to quality craftsmanship and are pleased to offer this Warranty. We suggest that you read it thoroughly. Should you have any questions, please contact your Dealer or contact Alpine at one of the telephone numbers listed below.

● PRODUCTS COVERED:

This Warranty covers Car Audio Products and Related Accessories ("the product"). Products purchased in the Canada are covered only in the Canada. Products purchased in the U.S.A. are covered only in the U.S.A.

● LENGTH OF WARRANTY:

This Warranty is in effect for one year from the date of the first consumer purchase.

● WHO IS COVERED:

This Warranty only covers the original purchaser of the product, who must reside in the United States, Puerto Rico or Canada.

● WHAT IS COVERED:

This Warranty covers defects in materials or workmanship (parts and labor) in the product.

● WHAT IS NOT COVERED:

This Warranty does not cover the following:

- ① Damage occurring during shipment of the product to Alpine for repair (claims must be presented to the carrier).
- ② Damage caused by accident or abuse, including burned voice coils caused by over-driving the speaker (amplifier level is turned up and driven into distortion or clipping). Speaker mechanical failure (e.g. punctures, tears or rips). Cracked or damaged LCD panels. Dropped or damaged hard drives.
- ③ Damage caused by negligence, misuse, improper operation or failure to follow instructions contained in the Owner's manual.
- ④ Damage caused by act of God, including without limitation, earthquake, fire, flood, storms or other acts of nature. Any cost or expense related to the removal or reinstallation of the product.
- ⑤ Service performed by an unauthorized person, company or association.
- ⑥ Any product which has the serial number defaced, altered or removed.
- ⑦ Any product which has been adjusted, altered or modified without Alpine's consent.
- ⑧ Any product not distributed by Alpine within the United States, Puerto Rico or Canada.
- ⑨ Any product not purchased from an Authorized Alpine Dealer.

● HOW TO OBTAIN WARRANTY SERVICE:

- ① You are responsible for delivery of the product to an Authorized Alpine Service Center or Alpine for repair and for payment of any initial shipping charges. Alpine will, at its option, repair or replace the product with a new or reconditioned product without charge. If the repairs are covered by the warranty, and if the product was shipped to an Authorized Alpine Service Center or Alpine, Alpine will pay the return shipping charges.
- ② You should provide a detailed description of the problem(s) for which service is required.

- ③ You must supply proof of your purchase of the product.
- ④ You must package the product securely to avoid damage during shipment. To prevent lost packages it is recommended to use a carrier that provides a tracking service.

● HOW WE LIMIT IMPLIED WARRANTIES:

ANY IMPLIED WARRANTIES INCLUDING FITNESS FOR USE AND MERCHANTABILITY ARE LIMITED IN DURATION TO THE PERIOD OF THE EXPRESS WARRANTY SET FORTH ABOVE AND NO PERSON IS AUTHORIZED TO ASSUME FOR ALPINE ANY OTHER LIABILITY IN CONNECTION WITH THE SALE OF THE PRODUCT.

● HOW WE EXCLUDE CERTAIN DAMAGES:

ALPINE EXPRESSLY DISCLAIMS LIABILITY FOR INCIDENTAL AND CONSEQUENTIAL DAMAGES CAUSED BY THE PRODUCT. THE TERM "INCIDENTAL DAMAGES" REFERS TO EXPENSES OF TRANSPORTING THE PRODUCT TO THE ALPINE SERVICE CENTER, LOSS OF THE ORIGINAL PURCHASER'S TIME, LOSS OF THE USE OF THE PRODUCT, BUS FARES, CAR RENTALS OR OTHERS COSTS RELATING TO THE CARE AND CUSTODY OF THE PRODUCT. THE TERM "CONSEQUENTIAL DAMAGES" REFERS TO THE COST OF REPAIRING OR REPLACING OTHER PROPERTY WHICH IS DAMAGED WHEN THIS PRODUCT DOES NOT WORK PROPERLY. THE REMEDIES PROVIDED UNDER THIS WARRANTY ARE EXCLUSIVE AND IN LIEU OF ALL OTHERS.

● HOW STATE/PROVINCIAL LAW RELATES TO THE WARRANTY:

This Warranty gives you specific legal rights, and you may also have other rights which vary from state to state and province to province. In addition, some states/provinces do not allow limitations on how long an implied warranty lasts, and some do not allow the exclusion or limitation of incidental or consequential damages. Accordingly, limitations as to these matters contained herein may not apply to you.

● IN CANADA ONLY:

This Warranty is not valid unless your Alpine car audio product has been installed in your vehicle by an Authorized Installation Center, and this warranty stamped upon installation by the installation center.

● HOW TO CONTACT CUSTOMER SERVICE:

Should the product require service, please call the following number for your nearest Authorized Alpine Service Center.

CAR AUDIO	1-800-ALPINE-1 (1-800-257-4631)
NAVIGATION	1-888-NAV-HELP (1-888-628-4357)

Or visit our website at; <http://www.alpine-usa.com>

ALPINE ELECTRONICS OF AMERICA, INC., 19145 Gramercy Place, Torrance, California 90501, U.S.A.

ALPINE ELECTRONICS OF CANADA, INC., 777 Supertest Road, Toronto, Ontario M3J 2M9, Canada

Do not send products to these addresses.

Call the toll free telephone number or visit the website to locate a service center.