



PHONES

(044) 360-7-130  
(050) 336-0-130  
(063) 788-0-130  
(067) 233-0-130  
(068) 282-0-130

130  
COM.UA

Internet store of  
autogoods



ICQ  
294-0-130  
597-0-130

SKYPE  
km-130

CAR RECEIVERS — Receivers • Media receivers and stations • Native receivers • CD/DVD changers • FM-modulators/USB adapters • Flash memory • Facia plates and adapters • Antennas • Accessories |  
CAR AUDIO — Car audio speakers • Amplifiers • Subwoofers • Processors • Crossovers • Headphones • Accessories | TRIP COMPUTERS — Universal computers • Model computers • Accessories |  
GPS NAVIGATORS — Portable GPS • Built-in GPS • GPS modules • GPS trackers • Antennas for GPS navigators • Accessories | VIDEO — DVR • TV sets and monitors • Car TV tuners • Cameras • Videomodules  
• Transcoders • Car TV antennas • Accessories | SECURITY SYSTEMS — Car alarms • Bike alarms • Mechanical blockers • Immobilizers • Sensors • Accessories | OPTIC AND LIGHT — Xenon • Bixenon • Lamps  
• LED • Stroboscopes • Optic and Headlights • Washers • Light, rain sensors • Accessories | PARKTRONICS AND MIRRORS — Rear parktronic • Front parktronic • Combined parktronic • Rear-view mirrors  
• Accessories | HEATING AND COOLING — Seat heaters • Mirrors heaters • Screen-wipers heaters • Engine heaters • Auto-refrigerators • Air conditioning units • Accessories | TUNING — Vibro-isolation  
• Noise-isolation • Tint films • Accessories | ACCESSORIES — Radar-detectors • Handsfree, Bluetooth • Windowlifters • Compressors • Beeps, loudspeakers • Measuring instruments • Cleaners • Carsits  
• Miscellaneous | MOUNTING — Installation kits • Upholstery • Grilles • Tubes • Cable and wire • Tools • Miscellaneous | POWER — Batteries • Converters • Start-charging equipment • Capacitors  
• Accessories | MARINE AUDIO AND ELECTRONICS — Marine receivers • Marine audio speakers • Marine subwoofers • Marine amplifiers • Accessories | CAR CARE PRODUCTS — Additives • Washer fluid •  
Care accessories • Car polish • Flavors • Adhesives and sealants | LIQUID AND OIL — Motor oil • Transmission oil • Brake fluid • Antifreeze • Technical lubricant



In store "130" you can find and buy almost all necessary goods for your auto in Kyiv and other cities, delivery by ground and postal services. Our experienced consultants will provide you with exhaustive information and help you to chose the very particular thing. We are waiting for you at the address

<http://130.com.ua>

FOR CAR USE ONLY/NUR FÜR AUTOMOBIL GEBRAUCH/POUR APPLICATION AUTOMOBILE UNIQUEMENT/PARA USO EN AUTOMÓVILES/SOLO PER L'UTILIZZO IN AUTOMOBILE/ENDAST FÖR BILBRUK/ALLEEN VOOR GEBRUIK IN DE AUTO/ТОЛЬКО ДЛЯ ИСПОЛЬЗОВАНИЯ В АВТОМОБИЛЯХ/DO UŻYCIA TYLKO W SAMOCHODZIE/GIA ΧΡΗΣΗ ΜΟΝΟ ΣΕ ΑΥΤΟΚΙΝΗΤΟ

# ALPINE®

Digital Media Receiver

## iDA-X303

**R-D-S EON**

**MP3**



**AAC**



**USB  
PLAYBACK**

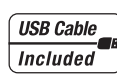
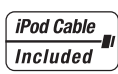

**Bluetooth  
Ready**

Digital Media Receiver

## iDA-X301/iDA-X301RR

**R-D-S EON**

**MP3**



**AAC**



**USB  
PLAYBACK**

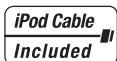

**Bluetooth  
Ready**

- OWNER'S MANUAL  
Please read before using this equipment.
- BEDIENUNGSANLEITUNG  
Lesen Sie diese Bedienungsanleitung bitte vor Gebrauch des Gerätes.
- MODE D'EMPLOI  
Veuillez lire avant d'utiliser cet appareil.
- MANUAL DE OPERACIÓN  
Léalo antes de utilizar este equipo.
- ISTRUZIONI PER L'USO  
Si prega di leggere prima di utilizzare il attrezzatura.
- ANVÄNDARHANDLEDNING  
Innan du använder utrustningen bör du läsa igenom denna användarhandledning.
- GEBRUIKERSHANDLEIDING  
Lees deze aanwijzingen aandachtig alvorens dit toestel te gebruiken.
- РУКОВОДСТВО ПО ЭКСПЛУАТАЦИИ  
Прочтите настоящее руководство перед началом использования оборудования.
- INSTRUKCJA OBSŁUGI  
Prosimy zapoznać się z tą instrukcją przed przystąpieniem do użytkowania urządzenia.
- ΕΓΧΕΙΡΙΔΙΟ ΧΡΗΣΤΗ  
Παρακαλούμε διαβάστε το πριν χρησιμοποιήσετε τη συσκευή.

**ALPINE ELECTRONICS MARKETING, INC.**  
1-1-8 Nishi Gotanda,  
Shinagawa-ku,  
Tokyo 141-0031, Japan  
Phone 03-5496-8231

**ALPINE ELECTRONICS OF AMERICA, INC.**  
19145 Gramercy Place, Torrance,  
California 90501, U.S.A.  
Phone 1-800-ALPINE-1 (1-800-257-4631)

**ALPINE ELECTRONICS OF CANADA, INC.**  
777 Superstest Road, Toronto,  
Ontario M3J 2M9, Canada  
Phone 1-800-ALPINE-1 (1-800-257-4631)

**ALPINE ELECTRONICS OF AUSTRALIA PTY. LTD.**  
161-165 Princes Highway, Hallam  
Victoria 3803, Australia  
Phone 03-8787-1200

**ALPINE ELECTRONICS GmbH**  
Frankfurter Ring 117, 80807 München, Germany  
Phone 089-32 42 640

**ALPINE ELECTRONICS OF U.K. LTD.**  
Alpine House  
Fletchamstead Highway, Coventry CV4 9TW, U.K.  
Phone 0870-33 33 763

**ALPINE ELECTRONICS FRANCE S.A.R.L.**  
(RCS PONTOISE B 338 101 280)  
98, Rue de la Belle Etoile, Z.I. Paris Nord II,  
B.P. 50016, 95945 Roissy Charles de Gaulle  
Cedex, France  
Phone 01-48638989

**ALPINE ITALIA S.p.A.**  
Viale C. Colombo 8, 20090 Trezzano  
Sul Naviglio (MI), Italy  
Phone 02-484781

**ALPINE ELECTRONICS DE ESPAÑA, S.A.**  
Portal de Gamarra 36, Pabellón, 32  
01013 Vitoria (Alava)-APDO 133, Spain  
Phone 945-283588

**ALPINE ELECTRONICS (BENELUX) GmbH**  
Leuvensesteenweg 510-B6,  
1930 Zaventem, Belgium  
Phone 02-725-13 15

EN

DE

FR

ES

IT

SE

NL

RU

PL

GR

---

## iDA-X303



**iPod**  
5th generation  
(video)  
30GB



**iPod**  
5th generation  
(video)  
60GB 80GB



**iPod nano**  
1st generation  
1GB 2GB 4GB



**iPod nano**  
2nd generation  
(aluminum)  
2GB 4GB 8GB



**iPod nano**  
3rd generation  
(video)  
4GB 8GB



**iPod classic**  
80GB 160GB



**iPod touch**  
1st generation  
8GB 16GB 32GB



**iPhone**  
4GB 8GB 16GB



**iPhone 3G**  
8GB 16GB

---

## iDA-X301/iDA-X301RR



**iPod**  
5th generation  
(video)  
30GB



**iPod**  
5th generation  
(video)  
60GB 80GB



**iPod nano**  
1st generation  
1GB 2GB 4GB



**iPod nano**  
2nd generation  
(aluminum)  
2GB 4GB 8GB



**iPod nano**  
3rd generation  
(video)  
4GB 8GB



**iPod classic**  
80GB 160GB



**iPod touch**  
1st generation  
8GB 16GB 32GB

# Contents

## Operating Instructions

### WARNING

<b>WARNING</b> .....	<b>3</b>
<b>CAUTION</b> .....	<b>3</b>
<b>PRECAUTIONS</b> .....	<b>3</b>

### Double Action Encoder Operation (iDA-X303 only)

#### Getting Started

Accessory List .....	6
Turning Power On and Off .....	6
Detaching and Attaching the Front Panel .....	6
Initial System Start-Up .....	6
Adjusting Volume .....	6

#### Radio

Listening to Radio .....	7
Presetting Stations Manually .....	7
Presetting Stations Automatically .....	7
Tuning to Preset Stations .....	7
Frequency Search Function .....	7

#### RDS

Setting RDS Reception Mode and Receiving RDS Stations .....	8
Receiving RDS Regional (Local) Stations .....	8
PI SEEK Setting .....	8
Setting PTY31 (Emergency Broadcast) reception .....	9
Receiving Traffic Information .....	9
PTY (Programme Type) Tuning .....	9
Receiving Traffic Information While Playing iPod or Radio .....	9
Priority News .....	10
Displaying Radio Text .....	10

### iPhone (iDA-X303 only)/iPod (Optional)

Playback .....	11
Searching for a desired Song/Title .....	11
Percent Skip Function .....	12
Alphabet Skip Function (iDA-X303 only) .....	12
Up/Down Function .....	12
Search Position Memory .....	13
Random Play Shuffle (M.I.X.) .....	13
Random Play Shuffle All .....	13
Repeat Play .....	13
Changing the Display .....	13

### USB memory/Portable audio player (iDA-X303 only)/Changer (Optional)

BANK Function (USB memory) .....	14
Playback .....	14
Selecting a Disc (Changer) (Optional) .....	15
Multi-Changer Selection (Optional) .....	15
Repeat Play .....	15
M.I.X. (Random Play) .....	16
Searching for CD Track Number (CD changer only) .....	16
Searching for a desired Song (USB memory/ Portable audio player (iDA-X303 only)) .....	16
File/Folder Name Search (MP3 Changer) .....	17
Switching between Quick Search mode and Folder up/down mode (MP3 changer) (iDA-X301/iDA-X301RR only) .....	17
Quick Search (changer) .....	17
Select the desired Folder (Folder up/down) (MP3/WMA/AAC) .....	18
Changing the Display .....	18
About MP3/WMA/AAC .....	18

## Sound Setting

Adjusting Subwoofer/Bass/Treble/Balance (Between Left and Right)/Fader (Between Front and Rear)/Loudness/Defeat .....	20
Turning Subwoofer ON/OFF .....	20
Setting the Subwoofer System .....	20
Setting the Bass Control .....	21
Setting the Treble Control .....	21
Adjusting the High Pass Filter .....	22
Operating the External Audio Processor .....	22

## SETUP

### Bluetooth Setting

Setting the Bluetooth Connection .....	23
--	----

### Audio Setting (Only when external audio processor is connected)

Operating the External Audio Processor (USER PRESET) .....	23
Turning Media Xpander ON/OFF .....	23
Setting the MX Level .....	23
Subwoofer On and Off .....	23

### General Setting

Connecting an MP3 Changer (PLAY MODE) .....	24
Sound (Beep) Guide Function (iDA-X303 only) .....	24
Turning Mute Mode On/Off (INT MUTE) .....	24
Setting the AUX+ Mode .....	24
Setting the AUX+ NAME Mode .....	24
Setting the AUX Mode (V-Link) .....	24
Setting the External Digital Input (DIGITAL AUX) .....	24
Setting the AUX+ Level (AUX IN GAIN) .....	24
Connecting to an External Amplifier (POWER IC) .....	25
Demonstration .....	25

### Display Setting

Dimmer Control .....	25
Scroll Type Setting .....	25
Scroll Setting (TEXT SCROLL) .....	25

### iPod Setting

iPod Search Mode Setting .....	25
--------------------------------	----

### TUNER Setting

Adjusting Source Signal Levels .....	25
--------------------------------------	----

## IMPRINT Operation (Optional) (iDA-X303 only)

Changing MultEQ mode .....	26
Adjusting Sound Setting in Manual Mode .....	26
USER PRESET .....	27
Storing the Audio Adjustment Level .....	27
Recalling the Audio Adjustment Level .....	27
Turning Media Xpander ON/OFF .....	27
Equalizer Presets (Factory's EQ) (FR-EQ) .....	27
Sound Field Adjustment .....	27
Adjusting the Parametric Equalizer Curve .....	27
Adjusting the Graphic Equalizer Curve .....	28
Adjusting the Time Correction .....	28
Adjusting the Crossover Settings (X-OVER) .....	28
Turning Subwoofer ON/OFF .....	29
Setting the Subwoofer System .....	29
Setting the Subwoofer Phase .....	29
Setting the Subwoofer Channel (SUBW CHANNEL) .....	30
Setting the Response Slope for the High Range Speaker (TW Setup) .....	30
Setting EQ mode .....	30
Setting the Filter type .....	30
Setting the Time Correction Unit (TCR) .....	30
Setting the MX Level .....	30
About Time Correction .....	31
About the Crossover .....	32
About IMPRINT .....	33

## Information

In Case of Difficulty .....	34
Specifications .....	37

## Installation and Connections

Warning .....	38
Caution .....	38
Precautions .....	38
Installation .....	39
Connections .....	41

# Operating Instructions

## WARNING

### WARNING

This symbol means important instructions. Failure to heed them can result in serious injury or death.

#### **DO NOT OPERATE ANY FUNCTION THAT TAKES YOUR ATTENTION AWAY FROM SAFELY DRIVING YOUR VEHICLE.**

Any function that requires your prolonged attention should only be performed after coming to a complete stop. Always stop the vehicle in a safe location before performing these functions. Failure to do so may result in an accident.

#### **KEEP THE VOLUME AT A LEVEL WHERE YOU CAN STILL HEAR OUTSIDE NOISES WHILE DRIVING.**

Excessive volume levels that obscure sounds such as emergency vehicle sirens or road warning signals (train crossings, etc.) can be dangerous and may result in an accident. LISTENING AT LOUD VOLUME LEVELS IN A CAR MAY ALSO CAUSE HEARING DAMAGE.

#### **MINIMIZE DISPLAY VIEWING WHILE DRIVING.**

Viewing the display may distract the driver from looking ahead of the vehicle and cause an accident.

#### **DO NOT DISASSEMBLE OR ALTER.**

Doing so may result in an accident, fire or electric shock.

#### **USE ONLY IN CARS WITH A 12 VOLT NEGATIVE GROUND.**

(Check with your dealer if you are not sure.) Failure to do so may result in fire, etc.

#### **KEEP SMALL OBJECTS SUCH AS BOLTS OR SCREWS OUT OF THE REACH OF CHILDREN.**

Swallowing them may result in serious injury. If swallowed, consult a physician immediately.

#### **USE THE CORRECT AMPERE RATING WHEN REPLACING FUSES.**

Failure to do so may result in fire or electric shock.

#### **DO NOT BLOCK VENTS OR RADIATOR PANELS.**

Doing so may cause heat to build up inside and may result in fire.

#### **USE THIS PRODUCT FOR MOBILE 12V APPLICATIONS.**

Use for other than its designed application may result in fire, electric shock or other injury.

### CAUTION

This symbol means important instructions. Failure to heed them can result in injury or material property damage.

#### **HALT USE IMMEDIATELY IF A PROBLEM APPEARS.**

Failure to do so may cause personal injury or damage to the product. Return it to your authorized Alpine dealer or the nearest Alpine Service Centre for repairing.

#### **DO NOT MIX NEW BATTERIES WITH OLD BATTERIES. INSERT WITH THE CORRECT BATTERY POLARITY.**

When inserting the batteries, be sure to observe proper polarity (+ and -) as instructed. Rupture or chemical leakage from the battery may cause fire or personal injury.

### PRECAUTIONS

#### **Product Cleaning**

Use a soft dry cloth for periodic cleaning of the product. For more severe stains, please dampen the cloth with water only. Anything else has the chance of dissolving the paint or damaging the plastic.

#### **Temperature**

Be sure the temperature inside the vehicle is between +60°C (+140°F) and -10°C (+14°F) before turning your unit on.

#### **Maintenance**

If you have problems, do not attempt to repair the unit yourself. Return it to your Alpine dealer or the nearest Alpine Service Station for servicing.

#### **Installation Location**

Make sure this unit will not be installed in a location subjected to:

- Direct sun and heat
- High humidity and water
- Excessive dust
- Excessive vibrations

#### **Protecting the USB connector**

- Only a USB memory, iPhone (iDA-X303 only), iPod (iDA-X303 only) or Portable audio player (iDA-X303 only) can be connected to the USB connector on this unit. Correct performance using other USB products cannot be guaranteed. A USB hub is not supported.
- If the USB connector is used, be sure to connect it to the unit by using a USB extension cable (supplied).
- Depending on the connected USB memory device, the unit may not function or some functions may not be performed.
- The audio file format that can be played back on the unit is MP3/WMA/AAC.
- Artist/song name, etc., can be displayed, however characters may not be correctly displayed.

## CAUTION

Alpine accepts no responsibility for lost data, etc., even if data, etc., is lost while using this product.

### On Handling USB Memory

- To prevent malfunction or damage, note the following points.  
Read the USB memory Owner's Manual thoroughly.  
Do not touch the terminals by hand or metal.  
Do not subject USB memory to excessive shock.  
Do not bend, drop, disassemble, modify or soak in the water.
- Avoid usage or storage in the following locations:  
Anywhere in the car exposed to direct sunlight or high temperatures.  
Anywhere the possibility of high humidity or corrosive substances are present.
- Fix the USB memory in a location where driver operation will not be hindered.
- USB memory may not function correctly at high or low temperature.
- Use only certified USB memory. Note that even certified USB memory, may not function correctly depending on its type or state.
- USB memory function is not guaranteed. Use USB memory according to the terms of agreement.
- Depending on the settings of the USB memory type, memory state or encoding software, the unit may not play back or display properly.
- Files that are copy-protected (using some type of DRM, Digital Rights Management) cannot be played back on this unit. WMA format files with DRM or AAC format files that have been purchased from the iTunes Store are included in this restriction.
- USB memory may take time to start playback. If there is a particular file other than audio in the USB memory, it may take considerable time before the file is played back or searched.
- The unit can play back "mp3", "wma" or "m4a" file extensions.
- Do not add the above extensions to a file other than audio data. This non-audio data will not be recognized. The resulting playback may contain noise that can damage speakers and/or amplifiers.
- It is recommended to back up important data on a personal computer.
- Do not remove the USB device while playback is in progress. Change SOURCE to something other than USB, then remove the USB device to prevent possible damage to its memory.

### On Handling Portable audio player (iDA-X303 only)

- The unit can control a Portable audio player with the USB interface. Playable audio file formats are MP3 and WMA.
  - Portable audio player function is not guaranteed. Use Portable audio player according to the terms of agreement. Read the Portable audio player Owner's Manual thoroughly.
  - Avoid usage or storage in the following locations:  
Anywhere in the car exposed to direct sunlight or high temperatures.  
Anywhere the possibility of high humidity or corrosive substances are present.
  - Fix the Portable audio player in a location where driver operation will not be hindered.
  - Portable audio player may not function correctly at high or low temperature.
  - Depending on the settings of the Portable audio player type, memory state or encoding software, the unit may not play back or display properly.
  - If the Portable audio player has an MSC/MTP setting, set to MTP.
  - A Portable audio player in which data is stored by USB Mass Storage may not be playable on the unit.
  - Depending on the Portable audio player settings, USB Mass Storage may be supported. For setting, refer to the Owner's Manual of the player.
  - The unit can play back MP3/WMA files synchronized by Windows Media Player (Ver. 7.1, 8, 9, 9.1, 9.2), and are then forwarded to the player. The "mp3" or "wma" extensions are playable.
  - If data is not synchronized by Windows Media Player and is forwarded in another way, the unit may not be able to correctly play back the files.
  - WMDRM10 is supported by the unit.
  - A file that is copy-protected (copyright protection) cannot be played back.
  - It is recommended to back up important data on a personal computer.
  - Do not remove the USB device while playback is in progress. Change SOURCE to something other than USB, then remove the USB device to prevent possible damage to its memory.
- 
- *Windows Media and the Windows logo are trademarks, or registered trademarks of Microsoft Corporation in the United States and/or other countries.*
  - *iPod is a trademark of Apple Inc., registered in the U.S. and other countries.*
  - *iPhone is a trademark of Apple Inc.*
  - *"Made for iPod" means that an electronic accessory has been designed to connect specifically to iPod and has been certified by the developer to meet Apple performance standards.*
  - *"Works with iPhone" means that an electronic accessory has been designed to connect specifically to iPhone and has been certified by the developer to meet Apple performance standards.*
  - *Apple is not responsible for the operation of this device or its compliance with safety and regulatory standards.*
  - *The Bluetooth word mark and logos are owned by the Bluetooth SIG, Inc. and any use of such marks by Alpine Electronics, Inc. is under license. Other trademarks and trade names are those of their respective owners.*
  - *"MPEG Layer-3 audio coding technology licensed from Fraunhofer IIS and Thomson."*
  - *"Supply of this product only conveys a license for private, non-commercial use and does not convey a license nor imply any right to use this product in any commercial (i.e. revenue-generation) real time broadcasting (terrestrial, satellite, cable and/or any other media), broadcasting/streaming via internet, intranets and/or other networks or in other electronic content distribution systems, such as pay-audio or audio-on-demand applications. An independent license for such use is required. For details, please visit <http://www.mp3licensing.com>"*
  - *Audyssey MultEQ XT is a registered trademark of Audyssey laboratories Inc.*

# Double Action Encoder Operation (iDA-X303 only)

Double Action encoder

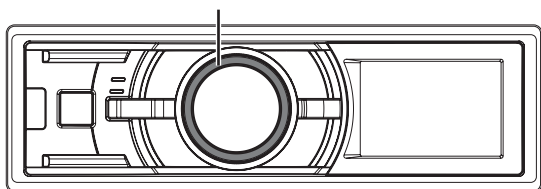

There are 2 ways to operate the Double Action encoder.

## Normal operation

Turn the **Double Action encoder** to the left or right.

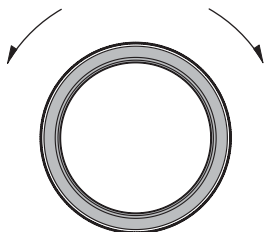

To adjust volume and scroll through a list of items.

## Alternate operation

Press and turn the **Double Action encoder** to the left or right.

When you release the Double Action encoder, the display changes.

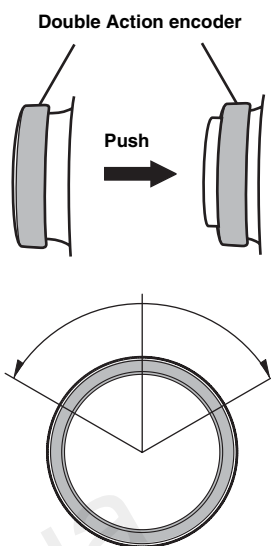

Depending on the situation, you can change an item or display. If you press and turn the **Double Action encoder** to the left or right, you can change items/displays continuously.

130.com.ua



# Getting Started

## iDA-X303

 (Release) Double Action encoder

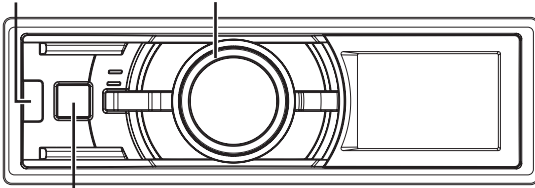

 SOURCE

## iDA-X301/iDA-X301RR

 (Release) Rotary encoder

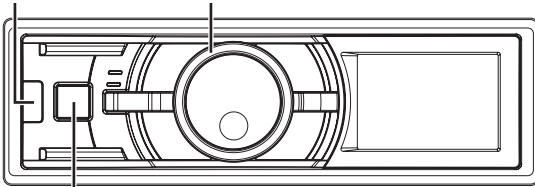

 SOURCE

- The front panel may become hot in normal usage (especially the connector terminals on the back of the front panel.) This is not a malfunction.
- To protect the front panel, place it in the supplied carrying case.

## Attaching

- 1 Insert the right side of the front panel into the main unit. Align the groove on the front panel with the projections on the main unit.
- 2 Push the left side of the front panel until it locks firmly into the main unit.

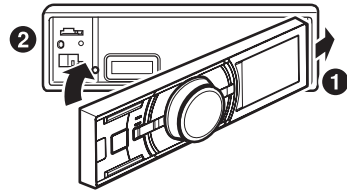

- Before attaching the front panel, make sure that there is no dirt or dust on the connector terminals and no foreign object between the front panel and the main unit.
- Attach the front panel carefully. Hold the panel by its sides to avoid pushing any buttons by mistake.

## Initial System Start-Up

Be sure to press the RESET switch when using the unit for the first time, after changing the car battery, etc.

- 1 Turn off the unit power.
- 2 Press  (Release) to remove the front panel.
- 3 Press **RESET** with a ballpoint pen or similar pointed object.

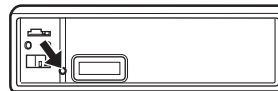

## Accessory List

- Digital Media receiver ..... 1
- Power cable ..... 1
- USB Cable ..... 1
- Interface cable for iPod (iDA-X303 only) ..... 1
- FULL SPEED™ Connection Cable (iDA-X301/iDA-X301RR only) ..... 1
- Mounting sleeve ..... 1
- Carrying case ..... 1
- Rubber Cap ..... 1
- Hex Bolt ..... 1
- Screw (M5x8) ..... 4
- Owner's Manual ..... 1 set

## Turning Power On and Off

Press  **SOURCE** to turn on the unit.

- The unit can be turned on by pressing any other button except  (Release) and Double Action encoder (iDA-X303 only). The unit is also automatically turned on if a USB memory/iPhone\*/iPod\* is connected to the USB connector.

\* iDA-X303 only.

Press and hold  **SOURCE** for at least 2 seconds to turn off the unit.

- The first time power is turned on, the volume will start from level 12.

## Detaching and Attaching the Front Panel

### Detaching

- 1 Turn off the unit power.
- 2 Press  (Release) at the middle left side until the front panel pops out.
- 3 Grasp the left side of the front panel and pull it out.

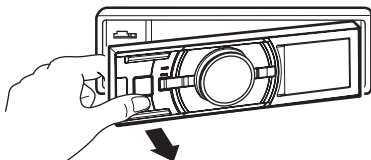

## Adjusting Volume

Turn the **Double Action encoder** (iDA-X303 only) or **Rotary encoder** (iDA-X301/iDA-X301RR only) until the desired sound is obtained.

### Controllable With Remote Control

Point the optional remote control transmitter at the remote control sensor.

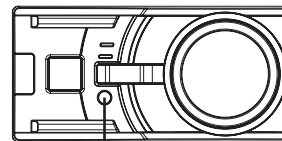

Remote control sensor

### Connectable to Steering Remote Control Interface Box

You can operate this unit from the vehicle's control unit when an Alpine Steering Remote Control Interface Box (optional) is connected. For details, contact your Alpine dealer.

# Radio

## iDA-X303

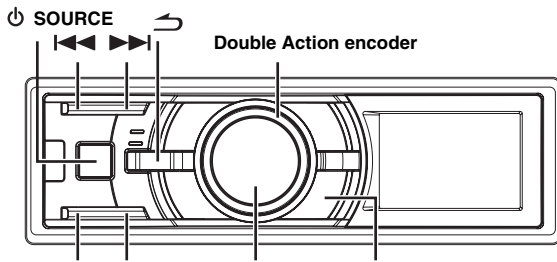

BAND/TA TUNE/A.ME Q/ENTER PRESET

## iDA-X301/iDA-X301RR

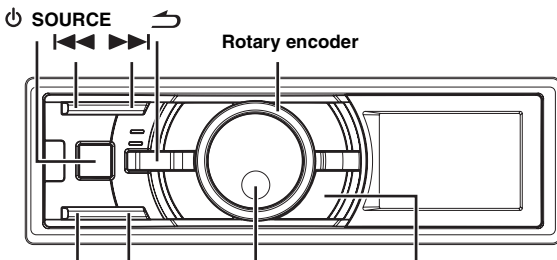

BAND/TA TUNE/A.ME Q/ENTER PRESET

## Listening to Radio

- 1 Press **SOURCE** to select TUNER mode.
- 2 Press **BAND/TA** repeatedly until the desired radio band is displayed.  
FM1 → FM2 → FM3 → MW → LW → FM1
- 3 Press **TUNE/A.ME** to select the tuning mode.  
DX SEEK (Distance mode) → SEEK (Local mode) →  
(Blank) (Manual mode) → DX SEEK (Distance mode)

- The initial mode is Distance mode.

### Distance mode:

Both strong and weak stations will be automatically tuned in (Automatic Seek Tuning).

### Local mode:

Only strong stations will be automatically tuned in (Automatic Seek Tuning).

### Manual mode:

The frequency is manually tuned in steps (Manual tuning).

- 4 Press **◀◀** or **▶▶** to tune in the desired station.  
Holding down **◀◀** or **▶▶** will change the frequency continuously.

## Presetting Stations Manually

- 1 Select the radio band and tune in a desired radio station you wish to store in the preset memory.
- 2 Press **PRESET**.  
The Preset screen is displayed.

- 3 Turn the **Double Action encoder** (iDA-X303 only) or **Rotary encoder** (iDA-X301/iDA-X301RR only) to select the preset number.
  - 4 Press and hold **Q/ENTER** for at least 2 seconds.  
The selected station is stored.  
The display shows the band, preset number and station frequency memorized.
- A total of 30 stations can be stored in the preset memory (6 stations for each band; FM1, FM2, FM3, MW and LW).
  - If you store a station in a preset memory which already has a station, the current station will be cleared and replaced with the new station.

## Presetting Stations Automatically

- 1 Press **BAND/TA** repeatedly until the desired radio band is displayed.
  - 2 Press and hold **TUNE/A.ME** for at least 2 seconds.  
The tuner will automatically seek and store 6 strong stations in the selected band. They will be stored 1 to 6 in order of signal strength.  
When the automatic memory has been completed, the tuner goes to the station stored in preset location No. 1.
- If no stations are stored, the tuner will return to the original station you were listening to before the auto memory procedure began.

## Tuning to Preset Stations

- 1 Press **BAND/TA** repeatedly until the desired band is displayed.
- 2 Press **PRESET**.  
The Preset screen is displayed.
- 3 Turn the **Double Action encoder** (iDA-X303 only) or **Rotary encoder** (iDA-X301/iDA-X301RR only) to select a radio station.
- 4 Press **Q/ENTER**.  
The display shows the band, preset number and frequency of the station selected.

## Frequency Search Function

You can search for a radio station by its frequency.

- 1 Press **Q/ENTER** in Radio mode to activate Frequency search mode.
  - 2 Turn the **Double Action encoder** (iDA-X303 only) or **Rotary encoder** (iDA-X301/iDA-X301RR only) to select the desired frequency.
  - 3 Press **Q/ENTER** to receive the selected frequency.
- Press **↵** in the search mode to cancel. Or, the search mode will be cancelled if no operation is performed for 10 seconds.

# RDS

iDA-X303

Double Action encoder FUNCTION/SETUP

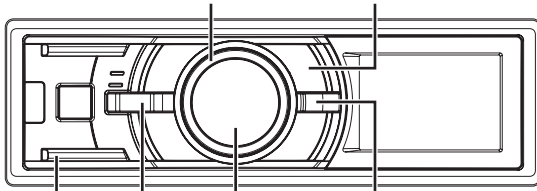

BAND/TA → Q/ENTER VIEW

iDA-X301/iDA-X301RR

Rotary encoder FUNCTION/SETUP

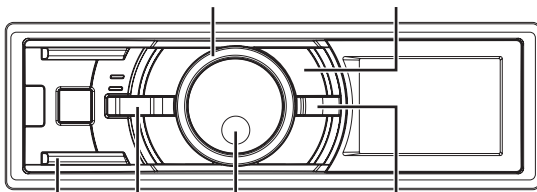

BAND/TA → Q/ENTER VIEW

## Setting RDS Reception Mode and Receiving RDS Stations

The RDS (Radio Data System) is a radio information system using the 57 kHz subcarrier of regular FM broadcast. The RDS allows you to receive a variety of information such as traffic information, station names, and to automatically re-tune to a stronger transmitter that is broadcasting the same programme.

- 1 Press **FUNCTION/SETUP** so that the <F> indicator lights up.
- 2 Turn the **Double Action encoder** (iDA-X303 only) or **Rotary encoder** (iDA-X301/iDA-X301RR only) to select the **AF (Alternative Frequency) mode**, and then press **Q/ENTER**.
- 3 Turn the **Double Action encoder** (iDA-X303 only) or **Rotary encoder** (iDA-X301/iDA-X301RR only) to select **ON**, and press **Q/ENTER**.
- 4 Press **FUNCTION/SETUP** to activate the **RDS mode**.

The <F> indicator goes out.

- Operate the unit while the <F> indicator lights up. If no operation is performed for 10 seconds, the <F> indicator goes out.
- When the "Setting PTY31 (Emergency Broadcast) reception" (refer to page 9) is set to ON, if the unit receives the PTY31 (Emergency Broadcast) signal, the unit will show "ALARM" in the display automatically.

The RDS digital data includes the following:

PI	Programme Identification
PS	Programme Service Name
AF	List of Alternative Frequencies
TP	Traffic Programme
TA	Traffic Announcement
PTY	Programme Type
EON	Enhanced Other Networks

## Receiving RDS Regional (Local) Stations

- 1 Press and hold **FUNCTION/SETUP** for at least 2 seconds to activate the **SETUP selection mode**.
- 2 Turn the **Double Action encoder** (iDA-X303 only) or **Rotary encoder** (iDA-X301/iDA-X301RR only) to select the **TUNER mode**, and then press **Q/ENTER**.

BT\*<sup>1</sup> ↔ AUDIO\*<sup>2</sup> ↔ GENERAL ↔ DISPLAY ↔ IPOD  
↔ TUNER ↔ BT

\*<sup>1</sup> Displayed only when **INT MUTE** is set to **OFF**, and the mode is set to other than **BT AUDIO**.

\*<sup>2</sup> Displayed only when an external audio processor is connected. For details, refer to the Owner's Manual of the external audio processor.

- 3 Turn the **Double Action encoder** (iDA-X303 only) or **Rotary encoder** (iDA-X301/iDA-X301RR only) to select **RDS REGIONAL**, and then press **Q/ENTER**.
- 4 Turn the **Double Action encoder** (iDA-X303 only) or **Rotary encoder** (iDA-X301/iDA-X301RR only) to select **ON or OFF**.  
In the **OFF** mode, the unit automatically keeps receiving the related local RDS station.

- 5 Press and hold → for at least 2 seconds to return to **normal mode**.

- Pressing → during the procedure will return to the previous mode.
- If no operation is performed for 60 seconds, the unit will return to normal mode automatically.

## PI SEEK Setting

- 1 Press and hold **FUNCTION/SETUP** for at least 2 seconds to activate the **SETUP selection mode**.
- 2 Turn the **Double Action encoder** (iDA-X303 only) or **Rotary encoder** (iDA-X301/iDA-X301RR only) to select the **TUNER mode**, and then press **Q/ENTER**.

BT\*<sup>1</sup> ↔ AUDIO\*<sup>2</sup> ↔ GENERAL ↔ DISPLAY ↔ IPOD  
↔ TUNER ↔ BT

\*<sup>1</sup> Displayed only when **INT MUTE** is set to **OFF**, and the mode is set to other than **BT AUDIO**.

\*<sup>2</sup> Displayed only when an external audio processor is connected. For details, refer to the Owner's Manual of the external audio processor.

- 3 Turn the **Double Action encoder** (iDA-X303 only) or **Rotary encoder** (iDA-X301/iDA-X301RR only) to select **PI SEEK** and then press **Q/ENTER**.
- 4 Turn the **Double Action encoder** (iDA-X303 only) or **Rotary encoder** (iDA-X301/iDA-X301RR only) to select **ON or OFF**.
- 5 Press and hold → for at least 2 seconds to return to **normal mode**.

- Pressing → during the procedure will return to the previous mode.
- If no operation is performed for 60 seconds, the unit will return to normal mode automatically.

---

## Setting PTY31 (Emergency Broadcast) reception

---

Turn PTY31 (Emergency Broadcast) reception ON/OFF.

- 1 Press and hold **FUNCTION/SETUP** for at least 2 seconds to activate the **SETUP** selection mode.
- 2 Turn the **Double Action encoder (iDA-X303 only) or Rotary encoder (iDA-X301/iDA-X301RR only)** to select the **TUNER** mode, and then press **Q/ENTER**.

BT\*<sup>1</sup> ↔ AUDIO\*<sup>2</sup> ↔ GENERAL ↔ DISPLAY ↔ IPOD  
↔ TUNER ↔ BT

\*<sup>1</sup> Displayed only when **INT MUTE** is set to **OFF**, and the mode is set to other than **BT AUDIO**.

\*<sup>2</sup> Displayed only when an external audio processor is connected. For details, refer to the Owner's Manual of the external audio processor.

- 3 Turn the **Double Action encoder (iDA-X303 only) or Rotary encoder (iDA-X301/iDA-X301RR only)** to select **ALERT PTY31** and then press **Q/ENTER**.

- 4 Turn the **Double Action encoder (iDA-X303 only) or Rotary encoder (iDA-X301/iDA-X301RR only)** to select **ON** or **OFF**.

If you set to **ON**, emergency broadcasts are received regardless of source. "ALARM" is displayed during reception.

- 5 Press and hold **↵** for at least 2 seconds to return to normal mode.

When an emergency broadcast is received, the volume level will be automatically changed to the memorized level in the traffic information mode. For details, refer to "Receiving Traffic Information" on page 9.

- Pressing **↵** during the procedure will return to the previous mode.
- If no operation is performed for 60 seconds, the unit will return to normal mode automatically.

---

## Receiving Traffic Information

---

- 1 Press and hold **BAND/TA** for at least 2 seconds so that the "TA" indicator lights up.

When a traffic information station is tuned in, the "TP" indicator lights up.

Traffic information is heard only when it is being broadcast. If traffic information is not being broadcast, the unit is set in the standby mode. When a traffic information broadcast begins, the unit automatically receives it and the TRF-INFO screen is displayed.

When the traffic information broadcast is over, the unit will automatically set in the standby mode.

- If the traffic information broadcast signal falls below a certain level, the unit remains in the receiving mode for 1 minute. If the signal remains below a certain level for over 1 minute, the "TA" indicator blinks.
- If you do not want to listen to the traffic information being received, lightly press **BAND/TA** to skip that traffic information message. The TA mode will remain in the ON position to receive the next traffic information message.
- If the volume level is changed while receiving traffic information, the changed volume level will be memorized. When traffic information is received next time, the volume level will be automatically adjusted to the level memorized.

---

## PTY (Programme Type) Tuning

---

- 1 Press **FUNCTION/SETUP** so that the <F> indicator lights up.

- 2 Turn the **Double Action encoder (iDA-X303 only) or Rotary encoder (iDA-X301/iDA-X301RR only)** to select **PTY**, and press **Q/ENTER**, while the unit is in **Radio (FM receiving) mode**.

The PTY Select screen is displayed.

- 3 Turn the **Double Action encoder (iDA-X303 only) or Rotary encoder (iDA-X301/iDA-X301RR only)** to choose the desired programme type.

- 4 Press **Q/ENTER** after selecting the programme type to start searching for a station in the selected programme type.

The chosen programme type display blinks during searching and lights when a station is found.

If no PTY station is found, "NO PTY" will be displayed for 10 seconds.

- Operate the unit while the <F> indicator lights up. If no operation is performed for 10 seconds, the <F> indicator goes out.

---

## Receiving Traffic Information While Playing iPod or Radio

---

- 1 Press and hold **BAND/TA** for at least 2 seconds so that the "TA" indicator lights up.

When a traffic information broadcast starts, the unit automatically mutes the iPod/USB memory/Portable audio player (iDA-X303 only)/changer or the regular FM broadcast.

When the traffic information broadcast finishes, the unit automatically returns to the original source play before the traffic information broadcast began.

### When traffic information stations cannot be received:

In the tuner mode:

When the TP signal can no longer be received for over 1 minute, the "TA" indicator blinks.

In the iPod/USB memory/Portable audio player (iDA-X303 only)/changer mode:

When the TP signal can no longer be received, the traffic information station of another frequency will be selected automatically.

- The receiver is equipped with the **EON (Enhanced Other Networks)** function in order to keep track of additional alternate frequencies to the AF list. The "EON" indicator lights up while an RDS EON station is being received. If the station being received does not broadcast the traffic information, the receiver automatically tunes in the related station that broadcasts the traffic information when it occurs.

- 2 Press and hold **BAND/TA** for at least 2 seconds to deactivate the Traffic Information mode.

The "TA" indicator goes out.

## Priority News

This function allows you to preset to give priority to the News programme. You will never miss the News programme as the unit automatically gives priority to the News programme whenever it begins broadcasting, and interrupts the programme you are currently listening. This feature is functional when your unit is set to a mode other than the LW and MW modes.

- 1 Press **FUNCTION/SETUP** to activate the Function mode while the unit is in Radio (FM receiving) mode. The <F> indicator lights up.
  - 2 Turn the **Double Action encoder (iDA-X303 only)** or **Rotary encoder (iDA-X301/iDA-X301RR only)** to select NEWS, and press **Q/ENTER**.
  - 3 Turn the **Double Action encoder (iDA-X303 only)** or **Rotary encoder (iDA-X301/iDA-X301RR only)** to select ON, and press **Q/ENTER**.
  - 4 Press **↶** to return to normal mode. The <F> indicator goes out.
- Operate the unit while the <F> indicator lights up. If no operation is performed for 10 seconds, the <F> indicator goes out.
  - In the NEWS function, unlike in the TA function, the volume does not increase automatically.

## Displaying Radio Text

Text messages from a radio station can be displayed.

Press **VIEW** while receiving FM in the radio mode to select the Radio Text display.

The display will change every time the button is pressed.

### If there is PS (Programme Service Name)



### If there is no PS (Programme Service Name)



- If there is no receivable text information or the unit cannot receive text information properly, "NO TEXT" will be displayed.

## iPhone (iDA-X303 only)/iPod (Optional)

### iDA-X303

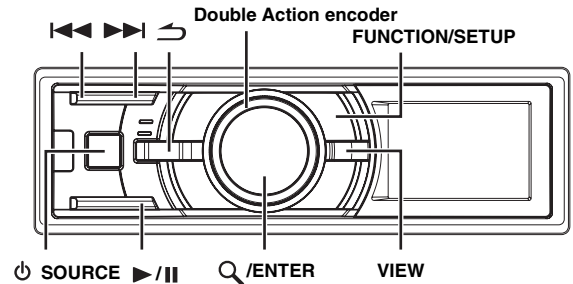

### iDA-X301/iDA-X301RR

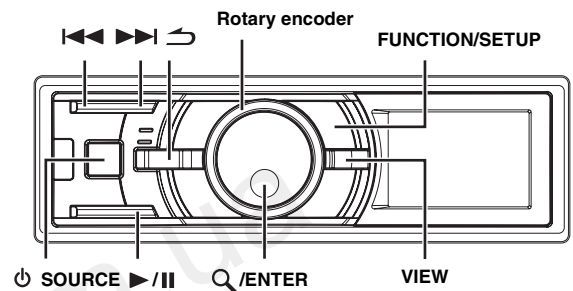

An iPhone (iDA-X303 only)/iPod can be connected to this unit. When this unit is connected, the controls on the iPod are not functional. Depending on the unit, iPhone (iDA-X303 only)/iPod connection can be made in two different ways.

**iDA-X303** : The iPhone/iPod only can be connected to the USB connector by using the Interface cable for iPod (supplied, iDA-X303 only).

**iDA-X301/ iDA-X301RR** : The iPod only can be connected to Full Speed connector by using the proprietary ALPINE FULL SPEED™ Connection Cable (KCE-433IV) (supplied, iDA-X301/iDA-X301RR only).

- Set AUX+ to OFF when an iPod is connected to iDA-X301/ iDA-X301RR, refer to "Setting the AUX+ Mode" on page 24.
- Internet and telephone functions of iPod touch or iPhone, etc., can also be used when connecting to the unit. However, using these functions will stop or pause the playing songs, at this time do not operate the unit to avoid a malfunction.
- If you connect an iPhone to this unit, it can be used as an iPod. If you use iPhone as a hands-free phone, you need the optional Bluetooth INTERFACE (KCE-400BT).
- If the Bluetooth INTERFACE (KCE-400BT) and an iPod are connected at the same time, be sure to disconnect the iPod from the Bluetooth INTERFACE (KCE-400BT) while turning ACC to OFF (only for iDA-X301/iDA-X301RR).

## iPhone (iDA-X303 only)/iPod models usable with this unit

- The unit can be used with the following iPhone/iPod models.
  - iPhone 3G (version 2.0) (iDA-X303 only)
  - iPhone (version 1.1.4) (iDA-X303 only)
  - iPod touch (version 1.0.4)
  - iPod classic (version 1.1.1)
  - iPod nano (3rd generation) (version 1.1)
  - iPod nano (2nd generation) (version 1.1.3)
  - iPod with video (version 1.2.3)
  - iPod nano (1st generation) (version 1.3.1)
- For clarity in identifying your model of iPod, please see Apple's own document "Identifying iPod models" at <http://support.apple.com/kb/HT1353>
- This unit does not support video playback from iPhone/iPod, even using a video-compatible cable.
- If the unit is used with versions of iTunes earlier than 7.6, correct function and performance are not guaranteed.

## Playback

**1** Press **⏏ SOURCE** to switch to the IPOD (iDA-X301/iDA-X301RR only) or USB IPOD (iDA-X303 only) mode.

**2** Press **⏮** or **⏭** to select the desired song.

*Return to the beginning of the current song:*

Press **⏮**.

*Fast backward through current song:*

Press and hold **⏮**.

*Advance to the beginning of the next song:*

Press **⏭**.

*Fast forward through current song:*

Press and hold **⏭**.

**3** To pause playback, press **⏸/||**.

Pressing **⏸/||** again will resume playback.

- If a song is playing on the iPhone (iDA-X303 only)/iPod when it is connected to this unit, it will continue playing after the connection.
- An episode or audiobook may have several chapters, the chapter can be changed by pressing **⏮** or **⏭**.

## Searching for a desired Song/Title

An iPhone (iDA-X303 only)/iPod can contain hundreds of songs. By keeping these songs organized in playlists, this unit can use these to ease song searches.

Using the Playlist/Artist/Album/Podcast/Audiobook/Genre/Composer/Song search mode's individual hierarchy, you can narrow down your search as shown in the table below.

Hierarchy 1	Hierarchy 2	Hierarchy 3	Hierarchy 4
PLAYLISTS	SONG	—	—
ARTISTS*	ALBUM*	SONG	—
ALBUMS*	SONG	—	—
PODCASTS	EPISODE	—	—
AUDIOBOOKS	—	—	—
GENRES*	ARTIST*	ALBUM*	SONG
COMPOSERS*	ALBUM*	SONG	—
SONGS	—	—	—

- You can select your preferred search mode. Refer to "iPod Search Mode Setting" (page 25).

### For example: Searching by Artist name

The following example explains how an ARTISTS search is performed. Another search mode can be used for the same operation, although the hierarchy differs.

**1** Press **🔍/ENTER** to activate the Menu Select mode.

**2** Turn the **Double Action encoder (iDA-X303 only) or Rotary encoder (iDA-X301/iDA-X301RR only)** to select the **ARTISTS**, and then press **🔍/ENTER**.

The artist search mode is activated and artists names are displayed.

**3** Turn the **Double Action encoder (iDA-X303 only) or Rotary encoder (iDA-X301/iDA-X301RR only)** to select the desired **Artist**, and then press **🔍/ENTER**.

The album search mode is activated and albums names are displayed.

**4** Turn the **Double Action encoder (iDA-X303 only) or Rotary encoder (iDA-X301/iDA-X301RR only)** to select an **album**, and then press **🔍/ENTER**.

The song search mode is activated and songs names are displayed.

**5** Turn the **Double Action encoder (iDA-X303 only) or Rotary encoder (iDA-X301/iDA-X301RR only)** to select a **song** and press **🔍/ENTER**.

The selected song is played back.

- While in the search mode, if you press and hold **↶** for at least 2 seconds the search mode is cancelled.
- In the search mode, pressing **↶** will return to the previous mode.
- When search is made during M.I.X. play, the M.I.X. play mode will be cancelled.
- "NO SONG" will be displayed if there are no songs in the selected playlist in the PLAYLISTS search mode.
- "NO PODCAST" will be displayed if there is no podcast data in the iPhone (iDA-X303 only)/iPod in the PODCASTS search mode.
- "NO A-BOOK" will be displayed if there is no audiobook data in the iPhone (iDA-X303 only)/iPod in the AUDIOBOOKS search mode.

- If “iPod name” stored in the iPhone (iDA-X303 only)/iPod is selected in the desired playlist search mode and **Q/ENTER** is pressed, you can search for all songs in the iPhone (iDA-X303 only)/iPod. Also, if you press and hold **Q/ENTER** for at least 2 seconds, all songs in the iPhone (iDA-X303 only)/iPod are played back.
- The display “NO SUPPORT” is scrolled if text information is not compatible with this unit.
- After selecting [ALL] in the search mode with “\*”, press and hold **Q/ENTER** for at least 2 seconds to play back all songs in the iPhone (iDA-X303 only)/iPod or selected search mode.
- If percent skip function is activated in the search mode, a search can be made quickly by skipping to the specified location. For details, refer to “Percent Skip Function” on page 12.
- If Alphabet Skip Function is activated in the search mode, a search can be made quickly by Alphabet function to find the desired artist or song, etc. For details, refer to “Alphabet Skip Function (iDA-X303 only)” on page 12.
- You can scroll the page by pressing and turning the **Double Action encoder** (iDA-X303 only).
- If no operation is performed for 60 seconds, the unit will return to normal mode automatically.

## Percent Skip Function

The unit is provided with a percent skip function for effective searching. When you use this function in the search mode, you can quickly search an artist or a song, etc.

If there are 100 songs in your iPhone (iDA-X303 only)/iPod, they are divided into 10 groups using percentages (shown below).

Number of song %	All 100 songs							
	10th song	20th song	...	50th song	...	80th song	...	100th song
10 %	■							
20 %	■	■						
⋮								
50 %	■	■	■	■	■			
⋮								
80 %	■	■	■	■	■	■	■	
⋮								
100 %	■	■	■	■	■	■	■	■

\* You can select to show a percentage of the total stored songs, in 10% steps.

### By using this function on iDA-X303

- 1 Press **FUNCTION/SETUP** repeatedly to choose the percent skip mode.

Alphabet skip function → Percent skip function →  
Normal search mode → Alphabet skip function

- 2 Press and turn the **Double Action encoder**.

Each turn of the **Double Action encoder** to the right will jump 10%, 20% and 100% in ascending order.

Each turn of the **Double Action encoder** to the left will jump 100%, 90% and 10% in descending order.

**Scroll bar display example (if 50% is shown)**



scroll bar

### By using this function on iDA-X301/ iDA-X301RR

- 1 Press **FUNCTION/SETUP** to activate the percent selection mode.
- 2 Turn the **Rotary encoder** to select a designated percent parameter, and then press **Q/ENTER**.  
The percent skip function jumps to the following selected 10% → 20%...50%...80%...100% → 10%.

## Alphabet Skip Function (iDA-X303 only)

The initial skip function is skipped to the next number, symbol or letter such as from A to B, B to C.

You can skip in reverse order such as B to A by turning the **Double Action encoder** to the left.

- 1 In the search mode, press **FUNCTION/SETUP** repeatedly to choose the alphabet skip mode.

Alphabet skip function → Percent skip function →  
Normal search mode → Alphabet skip function

- 2 Press and turn the **Double Action encoder**.

A list is skipped to the next page or next number, symbol or letter.

- If the **Double Action encoder** is pressed and turned to the left or right, the display continuously changes.
- The **Alphabet Skip Function** in the song search mode is available only when a song search is selected on the Menu select screen.
- Titles are listed alphabetically, and can be skipped every 200 titles. If there are fewer than 200 titles, titles beginning with the next alphabetical character are selected.

## Up/Down Function

If you select an album and press and hold **Q/ENTER** in the search mode, this album will be played back repeatedly. To go to the previous or next Album, use the Up/Down function.

### By using this function on iDA-X303

Press and turn the **Double Action encoder** to the left.  
Returns to the previous item.

Press and turn the **Double Action encoder** to the right.  
Advances to the next item.

## By using this function on iDA-X301/ iDA-X301RR

Press and hold **Q/ENTER** for at least 2 seconds, then turn the **Rotary encoder** to select the desired **Playlist/Artist/Album/Genre/Composer**.

- If you do not perform a search or only search for a song name or audiobook, this function is not valid.
- During an artist search, albums for that artist can be played.
- If an album is selected during an artist search, the Up/Down function can be used to play other albums by that artist.
- This function is inactive during shuffle playback.
- This function is also available for the USB/Portable audio player mode.

## Search Position Memory

During iPhone (iDA-X303 only)/iPod playback, you can quickly return to the last-selected hierarchy level in the search mode.

Press **↩**.

The hierarchy you selected last in the search mode is displayed.

## Random Play Shuffle (M.I.X.)

- 1 Press **FUNCTION/SETUP**.
- 2 Turn the **Double Action encoder (iDA-X303 only) or Rotary encoder (iDA-X301/iDA-X301RR only) to select M I X**, and press **Q/ENTER**.  
The Shuffle mode is activated.
- 3 Turn the **Double Action encoder (iDA-X303 only) or Rotary encoder (iDA-X301/iDA-X301RR only) to select the M I X (Shuffle) playback mode**, and press **Q/ENTER**.

- M I X ALBUM **⌘** : An album in the iPhone (iDA-X303 only)/iPod is selected at random, and is played back in the album song order.
- SONG **⌘** : If you select a song in the search mode, all songs in the selected mode are played back at random.
- OFF : Shuffle mode off.

- 4 Press **FUNCTION/SETUP**.  
The songs will be played back in random sequence.

- If no operation is performed for 10 seconds, the unit will return to normal mode.
- To cancel, select OFF in the above procedure.
- Shuffle Album/Shuffle Song works the same way as iPhone (iDA-X303 only)/iPod Shuffle Albums/Shuffle Songs.

## Random Play Shuffle All

Shuffle ALL plays all songs in the iPhone (iDA-X303 only)/iPod randomly.

- 1 Press **Q/ENTER**.  
The Menu Select screen is displayed.
  - 2 Press **Q/ENTER** while selecting **SHUFFLE ALL**.  
The indicator **⌘ ALL** lights, and the songs will be played back in random sequence.
- To cancel, set the Shuffle mode to OFF. Refer to "Random Play Shuffle (M.I.X.)" (page 13).
  - If SHUFFLE ALL is selected, the selected ones which are being played back in the search mode are cancelled.

## Repeat Play

- 1 Press **FUNCTION/SETUP**.  
The Function screen is displayed.
- 2 Press **Q/ENTER**.  
The Repeat mode is activated.
- 3 Turn the **Double Action encoder (iDA-X303 only) or Rotary encoder (iDA-X301/iDA-X301RR only) to select REPEAT SONG**, and press **Q/ENTER**.

- REPEAT SONG **⌘** : A single song is repeatedly played back.
- OFF : Repeat mode off.

- 4 Press **FUNCTION/SETUP**.  
The song is repeatedly played back.
- If no operation is performed for 10 seconds, the unit returns to normal mode.
  - To cancel, select OFF in the above procedure.
  - During repeat playback, no other songs are selectable by pressing **⏮** or **⏭**.

## Changing the Display

Press **VIEW**.

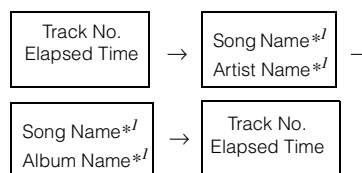

\*1 TAG information  
"ARTIST"/"ALBUM"/"SONG" is displayed if there is no tag information.

- Only alphanumeric characters can be displayed.
- The maximum number of characters is 128 (128 byte).
- Some characters may not be correctly displayed.
- "NO SUPPORT" is displayed when text information is not compatible with this unit.



# USB memory/Portable audio player (iDA-X303 only)/Changer (Optional)

## iDA-X303

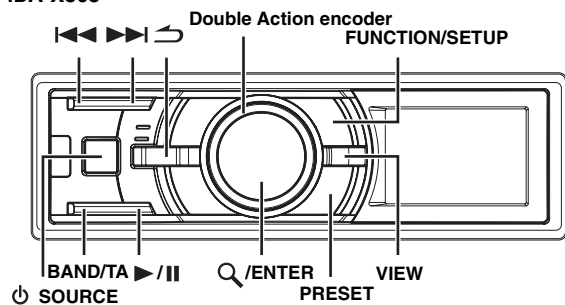

## iDA-X301/iDA-X301RR

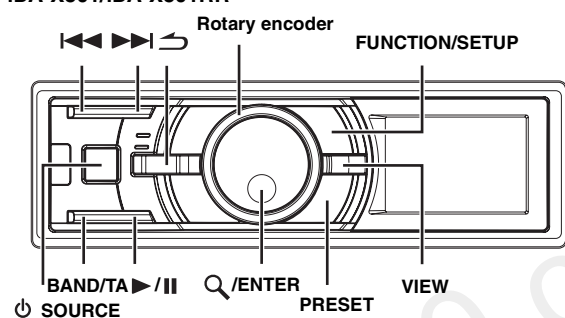

If a USB memory device/Portable audio player (iDA-X303 only) or changer is connected to the unit, MP3/WMA/AAC files can be played back.

- In the USB mode, when this unit is reset, ACC is switched from OFF to ON, or when the USB is connected to this unit, "BANKING" is displayed for several seconds.

## Using the USB Memory Banking Function

### 1. What is a Bank?

A bank is a unit of up to 1,000 songs, which is stored in memory. "Banking" refers to the grouping of songs available in USB memory, in banks of 1,000 songs each.

### 2. About Banking

While a bank is being built up, "BANKING" is displayed. Banking occurs whenever a USB memory device is connected or after power to the head unit turns on.

It can take anywhere from a few seconds to up to 10 minutes for banking to complete. This depends on the number of files and folders in USB memory.

### 3. Available operations while Banking

- Search functions, such as album search or tag information (artist display, etc.) are available. However, during Banking, the information display changes so the VIEW operation is not available.
- With a song playing, Regular fast-forwarding and next song selection is available.
- While Banking, the song playback order may differ from the song order in the USB memory device.

## BANK Function (USB memory)

This unit has a BANK function that automatically divides every 1,000 songs stored in USB memory into individual banks to make searching and playing back a song easier. A maximum of 1,000 songs for one bank can be stored according to the order stored in USB memory. A maximum of 10 banks (10,000 songs) can be recognized. BANK1 (songs 1 to 1,000) is set as the default. If you want to search beyond 1,000 songs, perform the following operation to select a different bank.

BANK No.	Song number
BANK1	1~1,000
BANK2	1,001~2,000
⋮	⋮
BANK10	9,001~10,000

- 1 Press PRESET.**  
The BANK selection mode is displayed.
  - 2 Turn the Double Action encoder (iDA-X303 only) or Rotary encoder (iDA-X301/iDA-X301RR only).**  
Select the desired BANK.  
You can scroll the page by pressing and turning the Double Action encoder (iDA-X303 only).
  - 3 Press Q/ENTER.**  
Each operation can be performed in the selected bank.
- Even if the files are contained in the same folder, they may be saved as different BANK.

## Playback

- 1 Press SOURCE to select the USB AUDIO or CHANGER mode.**
  - 2 Press I◀◀ or ▶▶I to select the desired track (file).**  
**Returning to the beginning of the current track (file):**  
Press I◀◀.  
**Fast backward:**  
Press and hold I◀◀.  
**Advancing to the beginning of the next track (file):**  
Press ▶▶I.  
**Fast forward:**  
Press and hold ▶▶I.
- When a Portable audio player is connected, fast-forwarding/fast-reversing is not available.

- 3 To pause playback, press ▶/II.**  
Pressing ▶/II again will resume playback.
- WMA format files that are protected by DRM (Digital Rights Management), AAC format files that have been purchased from the iTunes Store and files that are copy-protected (copyright protection) cannot be played back on this unit.
  - The playback time may not be correctly displayed when a VBR (Variable Bit Rate) recorded file is played back.
  - If there is tag information, artist name/album name/track name is displayed.
  - ID3 tag/WMA tag  
If an MP3/WMA/AAC file contains ID3 tag/WMA tag information, the ID3 tag/WMA tag information is displayed (e.g., song name, artist name, and album name). All other tag data is ignored.
  - "NO SUPPORT" is displayed when text information is not compatible with this unit.
  - Before disconnecting USB memory, be sure to change to another source or set to pause.

## Selecting a Disc (Changer) (Optional)

An optional 6-disc or 12-disc CD Changer may be connected to this unit if it is Ai-NET compatible. With a CD Changer connected to the Ai-NET input of this unit, the CD Changer will be controllable from this unit.

Using the KCA-410C (Versatile Link Terminal) multiple changers can be controlled by this unit.

See "Multi-Changer Selection (Optional)" on page 15 for selecting the CD Changers.

- The controls on this unit for CD Changer operation are operative only when a CD Changer is connected.
- The DVD changer (optional) is controllable from this unit as well as the CD changer.

### 1 Press **PRESET**.

The DISC CHANGE screen is displayed.

### 2 Turn the **Double Action encoder (iDA-X303 only) or Rotary encoder (iDA-X301/iDA-X301RR only) to select a disc.**

You can scroll the page by pressing and turning the Double Action encoder (iDA-X303 only).

### 3 Press **Q/ENTER**.

The selected disc number appears in the display and CD/MP3/WMA/AAC playback starts.

## Multi-Changer Selection (Optional)

When using KCA-410C (Versatile Link Terminal), you can connect two changers and two external outputs (AUX).

### 1 Press **SOURCE** on this unit to activate the **CD CHANGER mode**.

### 2 Press **BAND/TA** to activate the **CD Changer Selection mode**.

The CD Changer Selection mode remains active for several seconds.

### 3 Press **BAND/TA** until the desired CD Changer appears on the display.

- For further details about the external input (AUX) when using KCA-410C, see "Setting the AUX Mode (V-Link)" on page 24.

## Repeat Play



### 1 Press **FUNCTION/SETUP**.

### 2 Press **Q/ENTER**.

The repeat mode is activated.

### 3 Turn the **Double Action encoder (iDA-X303 only) or Rotary encoder (iDA-X301/iDA-X301RR only) to select the Repeat playback mode.**



#### USB memory mode :

- |            |   |  |
|------------|---|--|
| REPEAT ONE |  | : Only a track is repeatedly played back.            |
| FOLDER     |  | : Only files in a folder are repeatedly played back. |
| OFF        |   | : Repeat mode is turned off.                         |

#### Portable audio player mode (iDA-X303 only) :

- |             |   |   |
|-------------|---|---|
| REPEAT SONG |  | : Only a track is repeatedly played back. |
| OFF         |   | : Repeat mode is turned off.              |

#### CD Changer mode :

- |            |   |  |
|------------|---|--|
| REPEAT ONE |  | : Only a file is repeatedly played back.             |
| FOLDER *   |  | : Only files in a folder are repeatedly played back. |
| DISC       |  | : A disc is repeatedly played back.                  |
| OFF        |   | : Repeat mode is turned off.                         |

\* When an MP3 compatible CD changer is connected.

- If REPEAT DISC is set to ON during MIX ONE play in CD changer mode, M.I.X. will apply to the current disc only.

### 4 Press **Q/ENTER**.

### 5 Press **FUNCTION/SETUP**.

The track (file) will be played repeatedly.

- If no operation is performed for 10 seconds, the unit returns to normal mode.
- To cancel, select OFF in the above procedure.

## M.I.X. (Random Play)

- 1 Press **FUNCTION/SETUP**.
- 2 Turn the **Double Action encoder (iDA-X303 only) or Rotary encoder (iDA-X301/iDA-X301RR only)** to select **M I X**.
- 3 Press **Q/ENTER**.  
The M.I.X. mode is activated.
- 4 Turn the **Double Action encoder (iDA-X303 only) or Rotary encoder (iDA-X301/iDA-X301RR only)** to select the **M I X playback mode**.

### USB memory mode :

- M I X FOLDER** **☒** : Only files in a folder are played back in random sequence.
- ALL** **☒ ALL** : All songs in USB memory (current Bank) are played back in random sequence.
- OFF** : M.I.X. mode is turned off.

### Portable audio player mode (iDA-X303 only) :

- M I X SONG** **☒** : Only files in a folder are played back in random sequence.
- ALL** **☒ ALL** : All songs in portable audio player are played back in random sequence.
- OFF** : M.I.X. mode is turned off.

### CD Changer mode :

- M I X ONE** **☒** : All files in a disc are played back in random sequence, and playback shifts to the next disc.
- FOLDER** <sup>\*1</sup> **☒** : Only files in a folder are played back in random sequence.
- ALL** <sup>\*2</sup> **☒ ALL** : All the tracks on all the CDs in the current magazine will be played back in the random sequence.
- OFF** : M.I.X. mode is turned off.

<sup>\*1</sup> When an MP3 compatible CD changer is connected.

<sup>\*2</sup> When a CD changer equipped with the ALL M.I.X. function is connected.

- When a song is played back during Random (M.I.X.) play in the USB mode, the song can be played back again randomly even if not all songs on the USB Memory have been played back.
- If **M I X ONE** is set to **ON** during **REPEAT DISC** play in CD changer mode, **M.I.X.** will apply to the current disc only.

- 5 Press **Q/ENTER**.
  - 6 Press **FUNCTION/SETUP**.  
The tracks (files) will be played back in random sequence.
- If no operation is performed for 10 seconds, the unit returns to normal mode.
  - To cancel, select **OFF** in the above procedure.

## Searching for CD Track Number (CD changer only)

You can search for a song by track number.

- 1 Press **Q/ENTER** during play.  
This will set the search mode.
  - 2 Turn the **Double Action encoder (iDA-X303 only) or Rotary encoder (iDA-X301/iDA-X301RR only)** to select the desired track, and then press **Q/ENTER**.  
This will play the selected track.
- Press **↵** in the search mode to cancel. Or, the search mode is cancelled if no operation is performed for 60 seconds.
  - During list selection, if you turn the **Double Action encoder** to the left or right while pressed, the list screen scrolls screen by screen. If you turn and hold the **Double Action encoder** to the left or right while pressed, the list screen continuously scrolls (iDA-X303 only).
  - When CD Track Number Search is made during M.I.X. play, the M.I.X. play mode will be cancelled.

## Searching for a desired Song (USB memory/Portable audio player (iDA-X303 only))

A USB memory device/Portable audio player can contain hundreds of songs. By using file tag information and keeping these songs organized in playlists, this unit's search functions will ease song searches. Each music category has its own individual hierarchy. Use the Playlist/Artist/Album/Genre/Composer/Song/Folder/File search mode to narrow searches based on the table below.

Hierarchy 1	Hierarchy 2	Hierarchy 3	Hierarchy 4
PLAYLIST	SONG	—	—
ARTIST	ALBUM	SONG	—
ALBUM	SONG	—	—
GENRE	ARTIST	ALBUM	SONG
COMPOSER	ALBUM	SONG	—
SONG	—	—	—
FOLDER	FILE	—	—
FILE	—	—	—

### For example: Searching by Artist name

The following example explains how an ARTIST search is performed. Another search mode can be used for the same operation, although the hierarchy differs.

- 1 Press **Q/ENTER** to activate the search selection mode.
- 2 Turn the **Double Action encoder (iDA-X303 only) or Rotary encoder (iDA-X301/iDA-X301RR only)** to select the **ARTIST** search mode, and then press **Q/ENTER**.  
PLAYLIST ↔ ARTIST ↔ ALBUM ↔ GENRE ↔  
COMPOSER ↔ SONG ↔ FOLDER ↔ FILE ↔ PLAYLIST
- 3 Turn the **Double Action encoder (iDA-X303 only) or Rotary encoder (iDA-X301/iDA-X301RR only)** to select the desired Artist, and then press **Q/ENTER**.

**4** Turn the **Double Action encoder (iDA-X303 only)** or **Rotary encoder (iDA-X301/iDA-X301RR only)** to select an album, and then press **Q/ENTER**.

**5** Turn the **Double Action encoder (iDA-X303 only)** or **Rotary encoder (iDA-X301/iDA-X301RR only)** to select a song and press **Q/ENTER**.

The selected song is played back.

- After pressing and holding **Q/ENTER** for at least 2 seconds while in each hierarchy (except **SONG/FILE** hierarchy), all songs of the selected hierarchy are played back.
- Press and hold **↵** for at least 2 seconds in the search mode to cancel.
- While in the Search mode, press **↵** to switch to the previous mode.
- When search is made during **M.I.X.** play, the **M.I.X.** play mode will be cancelled.
- “**ROOT**” is displayed for the root folder which does not have folder name.
- In the search mode, you can scroll the page by pressing and turning the **Double Action encoder (iDA-X303 only)**.
- If no operation is performed for 60 seconds, the unit will return to normal mode automatically.
- In the search mode, when there is no tag information in the searched files, “**NO DATA**” will be displayed, it may also be displayed when searching some files depending on the property of the files.
- In **FOLDER/FILE** search mode, only the current **BANK**'s folders/files can be searched.

## File/Folder Name Search (MP3 Changer)

Folder and file names may be searched and displayed during playback.

**1** During **MP3/WMA/AAC** playback, press **Q/ENTER** to activate the search mode.

**2** Turn the **Double Action encoder (iDA-X303 only)** or **Rotary encoder (iDA-X301/iDA-X301RR only)** to select **Folder Name Search mode** or **File Name Search mode**, and then press **Q/ENTER**.

### Folder Name Search mode

**3** Turn the **Double Action encoder (iDA-X303 only)** or **Rotary encoder (iDA-X301/iDA-X301RR only)** to select the desired folder.

You can scroll the page by pressing and turning the **Double Action encoder (iDA-X303 only)**.

**4** Press and hold **Q/ENTER** for at least 2 seconds to play back the first file in the selected folder.

- Press and hold **↵** for at least 2 seconds in the search mode to cancel. Or, the search mode is cancelled if no operation is performed for 60 seconds.
- To search for files in the **Folder Name Search mode**, press **Q/ENTER**. Files in the folder may be searched.
- Press **↵** to exit **Folder Name Search mode** in step 3 in order to select **File Name Search mode**.
- “**ROOT**” is displayed for the root folder which does not have folder name.
- When **Folder Name Search** is made during **M.I.X.** play, the **M.I.X.** play mode will be cancelled.

### File Name Search mode

**3** Select the desired file by turning the **Double Action encoder (iDA-X303 only)** or **Rotary encoder (iDA-X301/iDA-X301RR only)**.

**4** Press **Q/ENTER** to play back the selected file.

- Press and hold **↵** for at least 2 seconds in the search mode to cancel. Or, the search mode is cancelled if no operation is performed for 60 seconds.
- Press **↵** in the search mode to return to the previous mode.
- When **File Name Search** is made during **M.I.X.** play, the **M.I.X.** play mode will be cancelled.

## Switching between Quick Search mode and Folder up/down mode (MP3 changer) (iDA-X301/iDA-X301RR only)

When an MP3 changer is connected, you can switch between the **Quick Search mode** and **Folder up/down mode**.

**1** Press **FUNCTION/SETUP**.

**2** Turn the **Rotary encoder** to select the desired adjust menu.

QUICK SEARCH: Quick Search mode  
FOLDER UP/DN: Folder up/down mode (Initial Setting)

**3** Press **Q/ENTER**.

The **ON/OFF** screen is displayed.

**4** Turn the **Rotary encoder**.

Select **ON**.

When **ON** is set, either **Quick Search mode** or **Folder up/down mode** can be used.

**5** Press **Q/ENTER**.

- You cannot set both **Quick Search mode** and **Folder up/down mode** to **ON**.
- If no operation is performed for 10 seconds, the unit will return to normal mode automatically.

## Quick Search (changer)

You can search for tracks (files).

**1** Press and hold **Q/ENTER** for at least 2 seconds in the **Changer mode** to activate **Quick Search mode**.

**2** Turn the **Double Action encoder (iDA-X303 only)** or **Rotary encoder (iDA-X301/iDA-X301RR only)** to select a desired track (file).

The selected track is played back immediately.

- Press **↵** in the search mode to cancel. Or, the search mode is cancelled if no operation is performed for 10 seconds.
- When an **MP3 changer** is connected, set the **Quick Search mode** to **ON**. For details, refer to “Switching between **Quick Search mode** and **Folder up/down mode (MP3 changer) (iDA-X301/iDA-X301RR only)**” (page 17).

## Select the desired Folder (Folder up/down) (MP3/WMA/AAC)

### By using this function on iDA-X303

Press and turn the **Double Action encoder** to select the desired folder.

Turning to the right will advance to the next folder.  
Turning to the left will return to the previous folder.  
The first file in the selected folder is played back.

### By using this function on iDA-X301/ iDA-X301RR

#### 1 Press **Q/ENTER** for at least 2 seconds.

The Folder up/down mode is activated.

#### 2 Turn the **Rotary encoder**.

Turning to the right will advance to the next folder.  
Turning to the left will return to the previous folder.  
The first file in the selected folder is played back.

- When an MP3 changer is connected, set the Folder up/down mode to ON. For details, refer to "Switching between Quick Search mode and Folder up/down mode (MP3 changer) (iDA-X301/iDA-X301RR only)" (page 17).
- If no operation is performed for 10 seconds, the unit will return to normal mode automatically (iDA-X301/iDA-X301RR only).
- USB Memory/Portable Audio Player (iDA-X303 only)  
During playback in normal mode, if you press and turn the **Double Action encoder** before you perform a search operation, the **FOLDER UP/DOWN** function will become activate. During playback in normal mode, if you press and turn the **Double Action encoder** after you perform a search operation, the **Up/Down** Function will become activate.

## Changing the Display

Press **VIEW**.

**USB/Portable audio player (iDA-X303 only) mode:**

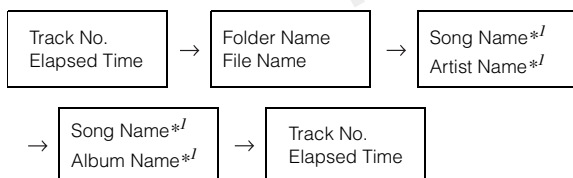

**CD Changer mode:**

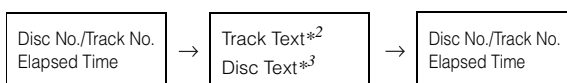

**MP3 Changer mode:**

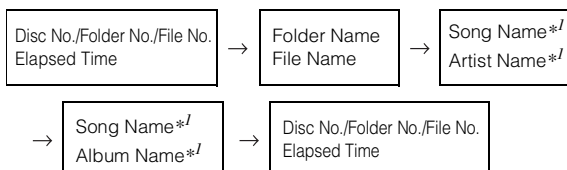

\*1 TAG information

"ARTIST"/"ALBUM"/"SONG" is displayed if there is no tag information.

\*2 "T TEXT" is displayed if there is no Track Text.

\*3 "D TEXT" is displayed if there is no Disc Text.

- Only alphanumeric characters can be displayed.
- The maximum number of characters is 128 (128 byte) for USB and portable audio player.
- The maximum number of characters is 64 (64 byte) for Changer.
- Some characters may not be correctly displayed.
- "NO SUPPORT" is displayed when text information is not compatible with this unit.

## About MP3/WMA/AAC

### CAUTION

Except for private use, duplicating audio data (including MP3/WMA/AAC data) or distributing, transferring, or copying it, whether for free or for a fee, without permission of the copyright holder is strictly prohibited by the Copyright Act and by international treaty.

### What is MP3?

MP3, whose official name is "MPEG-1 Audio Layer 3," is a compression standard prescribed by the ISO, the International Standardization Organization and MPEG which is a joint activity institution of the IEC.

MP3 files contain compressed audio data. MP3 encoding is capable of compressing audio data at extremely high ratios, reducing the size of music files to as much as one-tenth their original size. This is achieved while still maintaining near CD quality. The MP3 format realizes such high compression ratios by eliminating the sounds that are either inaudible to the human ear or masked by other sounds.

### What is AAC?

AAC is the abbreviation for "Advanced Audio Coding", and is a basic format of audio compression used by MPEG2 or MPEG4.

### What is WMA?

WMA, or "Windows Media™ Audio", is compressed audio data. WMA is similar to MP3 audio data and can achieve CD quality sound with small file sizes.

### **Method for creating MP3/WMA/AAC files**

Audio data is compressed by using MP3/WMA/AAC specified software. For details on creating MP3/WMA/AAC files, refer to the user's manual for that software.

MP3/WMA/AAC file extensions that can be played back on the unit are as follows:

MP3: ".mp3"

WMA: ".wma" (ver. 7.1, 8, 9, 9.1, 9.2 supported)

AAC: ".m4a"

WMA is not supported for the following files, Windows Media Audio Professional, Windows Media Audio 9 Voice or Windows Media Audio 9 Pro Lossless.

Depending on the software that is used to create AAC, the file format may differ from the extension.

Playback of AAC files encoded by iTunes is supported.

### **Supported playback sampling rates and bit rates**

#### **MP3**

Sampling rates: 48 kHz, 44.1 kHz, 32 kHz, 24 kHz, 22.05 kHz, 16 kHz, 12 kHz, 11.025 kHz, 8 kHz

Bit rates: 32 - 320 kbps

#### **WMA**

Sampling rates: 48 kHz, 44.1 kHz, 32 kHz, 24 kHz, 22.05 kHz, 16 kHz

Bit rates: 16 - 320 kbps

#### **AAC**

Sampling rates: 48 kHz, 44.1 kHz

Bit rates: 8 - 576 kbps

This device may not play back correctly depending on sampling rates.

The playback time may not be correctly displayed when a VBR (Variable Bit Rate) recorded file is played back.

### **ID3 tags/WMA tags**

This device supports ID3 tag v1 and v2.2.0, v2.3.0 and WMA tag. The following files do not support compression, coding, grouping or non-synchronization.

If tag data is in an MP3/WMA/AAC file, this device can display the title (track title), artist name, and album name ID3 tag/WMA tag data.

This device can only display single-byte alphanumeric characters and the underscore. For non-supported characters, "NO SUPPORT" is displayed.

If information contains characters other than ID3 tag information, the audio file may not be played back.

The tag information may not be correctly displayed, depending on the contents.

### **Playing back MP3/WMA/AAC**

MP3/WMA/AAC files are prepared, and then written to USB memory. Or, synchronize an MP3/WMA file using Windows Media Player (Ver. 7.1, 8, 9, 9.1, 9.2), and then forward to the Portable audio player.

A USB memory device can hold up to 10,000 files/1,000 folders (including Root Folders). Playback may not be performed if a USB memory/Portable audio player device exceeds the limitations described above.

Do not make a file's playback time more than 1 hour.

### **Media supported**

This device can play back USB memory/Portable audio player media.

### **Corresponding File Systems**

This device supports FAT 12/16/32.

## **Terminology**

### **Bit rate**

*This is the "sound" compression rate specified for encoding. The higher the bit rate, the higher the sound quality, but also the larger the files.*

### **Sampling rate**

*This value shows how many times per second the data is sampled (recorded). For example, music CDs use a sampling rate of 44.1 kHz, so the sound is sampled (recorded) 44,100 times per second. The higher the sampling rate, the higher the sound quality, but also the larger the volume of data.*

### **Encoding**

*Converting music CDs, WAVE (AIFF) files, and other sound files into the specified audio compression format.*

### **Tag**

*Song information such as track titles, artist names, album names, etc., written into MP3/WMA/AAC files.*

### **Root folder**

*The root folder is found at the top of the file system. The root folder contains all folders and files.*

# Sound Setting

iDA-X303

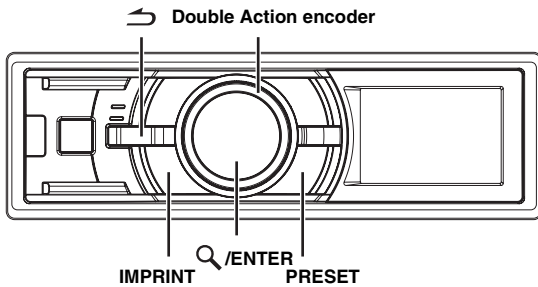

iDA-X301/iDA-X301RR

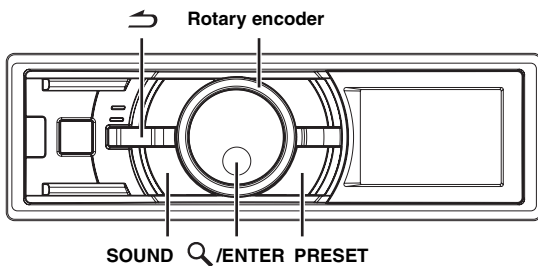

## Adjusting Subwoofer/Bass/Treble/Balance (Between Left and Right)/Fader (Between Front and Rear)/Loudness/Defeat

- 1 Press **IMPRINT** (iDA-X303 only) or **SOUND** (iDA-X301/iDA-X301RR only) repeatedly to choose the desired mode.

Each press changes the mode as follows:

SUBW LV<sup>\*1</sup> → BASS LV → TREBLE LV → BALANCE LV →  
FADER LV<sup>\*2</sup> → LOUD<sup>\*3</sup> → DEFEAT → VOLUME →  
SUBW LV<sup>\*1</sup>

Subwoofer: 0 ~ +15

Bass level: -7 ~ +7

Treble level: -7 ~ +7

Balance: -15 ~ +15

Fader: -15 ~ +15

Loudness : ON/OFF

Defeat : ON/OFF

Volume: 0 ~ 35

- If **IMPRINT** (iDA-X303 only) or **SOUND** (iDA-X301/iDA-X301RR only) is not pressed within 5 seconds after selecting the Subwoofer, Bass, Treble, Balance or Fader mode, the unit automatically returns to normal mode.
- Loudness introduces a special low-and high-frequency emphasis at low listening levels. This compensates for the ear's decreased sensitivity to bass and treble sound. The function is inoperable when **DEFEAT** is set to ON.

<sup>\*1</sup> When the subwoofer mode is set to OFF, its level cannot be adjusted.

<sup>\*2</sup> If you set the 2.2ch (3WAY)/4.2ch (FRONT/REAR/SUBW.) switch of the IMPRINT audio processor (PXA-H100) to 2.2ch (3WAY), you cannot adjust the FADER mode. For details, refer to the Owner's Manual of PXA-H100.

<sup>\*3</sup> When an external audio processor is connected, this setting cannot be made.

- 2 Turn the **Double Action encoder** (iDA-X303 only) or **Rotary encoder** (iDA-X301/iDA-X301RR only) until the desired sound is obtained in each mode.

- Depending on the connected devices, some functions and display indications do not work.

## Turning Subwoofer ON/OFF

When the subwoofer is on, you can adjust the subwoofer output level (refer to page 20).

For iDA-X303, the following setting can be made only when the IMPRINT audio processor (PXA-H100) is not connected.

- 1 Press and hold **IMPRINT** (iDA-X303 only) or **SOUND** (iDA-X301/iDA-X301RR only) for at least 2 seconds to activate the AUDIO selection mode.
- 2 Turn the **Double Action encoder** (iDA-X303 only) or **Rotary encoder** (iDA-X301/iDA-X301RR only) to select the SUBW mode, and then press Q/ENTER.

SUBW ↔ SUBW SYSTEM\* ↔ BASS ↔ TREBLE ↔ HPF  
↔ SUBW

- \* Displayed only when subwoofer is ON.

- 3 Turn the **Double Action encoder** (iDA-X303 only) or **Rotary encoder** (iDA-X301/iDA-X301RR only) to select SUBW ON/OFF, and then press Q/ENTER.

ON ↔ OFF

- 4 Press ↶ to return to normal mode.

- If no operation is performed for 15 seconds, the unit will return to normal mode automatically.
- If ↶ is pressed during setting, the unit returns to the previous item.

## Setting the Subwoofer System

When the subwoofer is on, you can select either SYS 1 or SYS 2 for the desired subwoofer effect.

For iDA-X303, the following setting can be made only when the IMPRINT audio processor (PXA-H100) is not connected.

- 1 Press and hold **IMPRINT** (iDA-X303 only) or **SOUND** (iDA-X301/iDA-X301RR only) for at least 2 seconds to activate the AUDIO selection mode.
- 2 Turn the **Double Action encoder** (iDA-X303 only) or **Rotary encoder** (iDA-X301/iDA-X301RR only) to select the SUBW SYSTEM mode, and then press Q/ENTER.

SUBW ↔ SUBW SYSTEM\* ↔ BASS ↔ TREBLE ↔  
HPF ↔ SUBW

- \* Displayed only when subwoofer is ON.

- 3 Turn the **Double Action encoder** (iDA-X303 only) or **Rotary encoder** (iDA-X301/iDA-X301RR only) to select the SUBW SYS 1 or SUBW SYS 2, and then press Q/ENTER.

SYS 1 ↔ SYS 2

SYS 1: Subwoofer level changes according to the main volume setting.

SYS 2: Subwoofer level change is different from the main volume setting. For example, even at low volume settings, the subwoofer is still audible.

#### 4 Press $\rightarrow$ to return to normal mode.

- If no operation is performed for 15 seconds, the unit will return to normal mode automatically.
- If  $\rightarrow$  is pressed during setting, the unit returns to the previous item.
- This function is inoperable when Subwoofer is set to OFF.

## Setting the Bass Control

You can change the Bass Frequency emphasis to create your own tonal preference.

For iDA-X303, the following setting can be made only when the IMPRINT audio processor (PXA-H100) is not connected.

1 Press and hold **IMPRINT** (iDA-X303 only) or **SOUND** (iDA-X301/iDA-X301RR only) for at least 2 seconds to activate the **AUDIO** selection mode.

2 Turn the **Double Action encoder** (iDA-X303 only) or **Rotary encoder** (iDA-X301/iDA-X301RR only) to select the **BASS** Adjustment mode, and then press **Q/ENTER**.

SUBW  $\leftrightarrow$  SUB SYSTEM\*  $\leftrightarrow$  BASS  $\leftrightarrow$  TREBLE  $\leftrightarrow$  HPF  $\leftrightarrow$  SUBW

\* Displayed only when subwoofer is ON.

### Setting the Bass Level

3-1\*<sup>1</sup> Turn the **Double Action encoder** (iDA-X303 only) or **Rotary encoder** (iDA-X301/iDA-X301RR only) to select the desired bass level (-7~+7), and then press **Q/ENTER**.

You can emphasize or weaken the bass level.

### Setting the Bass Bandwidth

3-2 Turn the **Double Action encoder** (iDA-X303 only) or **Rotary encoder** (iDA-X301/iDA-X301RR only) to select the desired bass bandwidth, and then press **Q/ENTER**.

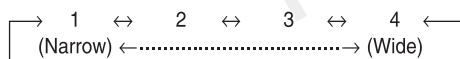

Changes the boosted bass bandwidth to wide or narrow. A wider setting will boost a wide range of frequencies above and below the centre frequency. A narrower setting will boost only frequencies near the centre frequency.

### Setting the Bass Centre Frequency

3-3 Turn the **Double Action encoder** (iDA-X303 only) or **Rotary encoder** (iDA-X301/iDA-X301RR only) to select the desired bass centre frequency, and then press **Q/ENTER**.

80 (Hz)  $\leftrightarrow$  100 (Hz)  $\leftrightarrow$  200 (Hz)  $\leftrightarrow$  60 (Hz)  $\leftrightarrow$  80 (Hz)

Emphasizes the displayed bass frequency ranges.

#### 4 Press $\rightarrow$ to return to normal mode.

- If no operation is performed for 15 seconds, the unit will return to normal mode automatically.
- If  $\rightarrow$  is pressed during setting, the unit returns to the previous item.
- The function is inoperable when DEFEAT is set to ON.

\*<sup>1</sup> The adjustment can also be made by pressing **IMPRINT** (iDA-X303 only) or **SOUND** (iDA-X301/iDA-X301RR only). Refer to "Adjusting Subwoofer/Bass/Treble/Balance (Between Left and Right)/Fader (Between Front and Rear)/Loudness/Defeat" (page 20).

## Setting the Treble Control

You can change the Treble Frequency emphasis to create your own tonal preference.

For iDA-X303, the following setting can be made only when the IMPRINT audio processor (PXA-H100) is not connected.

1 Press and hold **IMPRINT** (iDA-X303 only) or **SOUND** (iDA-X301/iDA-X301RR only) for at least 2 seconds to activate the **Audio Selection** mode.

2 Turn the **Double Action encoder** (iDA-X303 only) or **Rotary encoder** (iDA-X301/iDA-X301RR only) to select the **TREBLE** Adjustment mode, and then press **Q/ENTER**.

SUBW  $\leftrightarrow$  SUBW SYSTEM\*  $\leftrightarrow$  BASS  $\leftrightarrow$  TREBLE  $\leftrightarrow$  HPF  $\leftrightarrow$  SUBW

\* Displayed only when subwoofer is ON.

### Setting the Treble Level

3-1\*<sup>2</sup> Turn the **Double Action encoder** (iDA-X303 only) or **Rotary encoder** (iDA-X301/iDA-X301RR only) to select the desired treble level (-7~+7), and then press **Q/ENTER**.

You can emphasize the treble level.

### Setting the Treble Centre Frequency

3-2 Turn the **Double Action encoder** (iDA-X303 only) or **Rotary encoder** (iDA-X301/iDA-X301RR only) to select the desired treble centre frequency, and then press **Q/ENTER**.

10.0 kHz  $\leftrightarrow$  12.5 kHz  $\leftrightarrow$  15.0 kHz  $\leftrightarrow$  17.5 kHz  $\leftrightarrow$  10.0 kHz

Emphasizes the displayed treble frequency ranges.

#### 4 Press $\rightarrow$ to return to normal mode.

- If no operation is performed for 15 seconds, the unit will return to normal mode automatically.
- If  $\rightarrow$  is pressed during setting, the unit returns to the previous item.
- The function is inoperable when DEFEAT is set to ON.

\*<sup>2</sup> The adjustment can also be made by pressing **IMPRINT** (iDA-X303 only) or **SOUND** (iDA-X301/iDA-X301RR only). Refer to "Adjusting Subwoofer/Bass/Treble/Balance (Between Left and Right)/Fader (Between Front and Rear)/Loudness/Defeat" (page 20).



## Adjusting the High Pass Filter

The High Pass Filter on this unit can be adjusted to suit your personal taste.

For iDA-X303, the following setting can be made only when the IMPRINT audio processor (PXA-H100) is not connected.

**1** Press and hold **IMPRINT** (iDA-X303 only) or **SOUND** (iDA-X301/iDA-X301RR only) for at least 2 seconds to activate the **AUDIO** selection mode.

**2** Turn the **Double Action encoder** (iDA-X303 only) or **Rotary encoder** (iDA-X301/iDA-X301RR only) to select the HPF Adjustment mode, and then press **Q/ENTER**.

SUBW ↔ SUB SYSTEM\* ↔ BASS ↔ TREBLE ↔ HPF  
↔ SUBW

\* Displayed only when subwoofer is ON.

**3** Turn the **Double Action encoder** (iDA-X303 only) or **Rotary encoder** (iDA-X301/iDA-X301RR only) to select the desired HPF frequency, and then press **Q/ENTER**.

OFF ↔ 80 (Hz) ↔ 120 (Hz) ↔ 160 (Hz)

**4** Press **↶** to return to normal mode.

- If no operation is performed for 15 seconds, the unit will return to normal mode automatically.
- If **↶** is pressed during setting, the unit returns to the previous item.
- The function is inoperable when **DEFEAT** is set to ON.

## Operating the External Audio Processor

You can call up the preset memory of the external audio processor from this unit.

**1** Press and hold **PRESET** for at least 2 seconds to call the external audio processor mode when the external audio processor is connected.

The AP Preset screen is displayed.

**2** Turn the **Double Action encoder** (iDA-X303 only) or **Rotary encoder** (iDA-X301/iDA-X301RR only) to select the preset number, and press **Q/ENTER**.

- For the operation of external audio processor, refer to the Owner's Manual of the external audio processor you purchased.

## SETUP

Use the **SETUP** menu to flexibly customize the unit to suit your own preferences and usage. Choose settings from **GENERAL**, **DISPLAY**, etc., to make the desired changes.

### iDA-X303

⏻ **SOURCE** Double Action encoder **FUNCTION/SETUP**

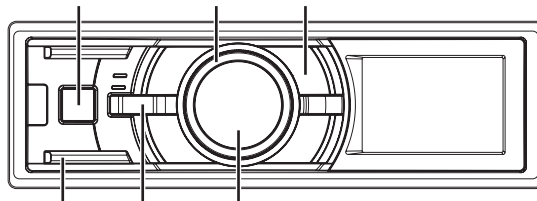

BAND/TA ↶ Q/ENTER

### iDA-X301/iDA-X301RR

⏻ **SOURCE** Rotary encoder **FUNCTION/SETUP**

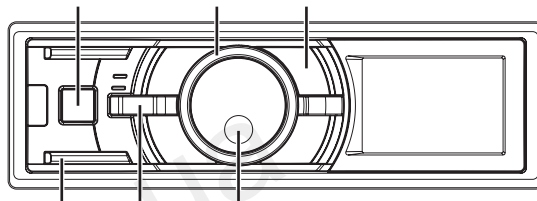

BAND/TA ↶ Q/ENTER

Follow steps 1 to 5 to choose an item to change. See the item descriptions following step 5 for further details.

**1** Press and hold **FUNCTION/SETUP** for at least 2 seconds to activate the **SETUP** selection mode.

**2** Turn the **Double Action encoder** (iDA-X303 only) or **Rotary encoder** (iDA-X301/iDA-X301RR only) to select the desired item, and then press **Q/ENTER**.

BT\*<sup>1</sup> ↔ AUDIO\*<sup>2</sup> ↔ GENERAL ↔ DISPLAY ↔ IPOD ↔  
TUNER ↔ BT  
(e.g. Select GENERAL)

\*<sup>1</sup> Displayed only when **INT MUTE** is set to **OFF**, and the mode is set to other than **BT AUDIO**.

\*<sup>2</sup> Displayed only when an external audio processor is connected. For details, refer to the Owner's Manual of the external audio processor.

### 3 Turn the Double Action encoder (iDA-X303 only) or Rotary encoder (iDA-X301/iDA-X301RR only) to select a setting item, and then press **Q/ENTER**. (e.g. Select POWER IC)

BT:

BT IN

AUDIO\*<sup>3</sup>:

USER PRESET\*<sup>4</sup> ↔ MX\*<sup>4</sup> ↔ SUBW\*<sup>4</sup> ↔ MX LEVEL\*<sup>5</sup> ↔ USER PRESET\*<sup>4</sup>

GENERAL:

PLAY MODE ↔ BEEP\*<sup>6</sup> ↔ INT MUTE\*<sup>7</sup> ↔ AUX+ ↔ AUX+ NAME\*<sup>8</sup> ↔ AUX ↔ AUX NAME\*<sup>8</sup> ↔ DIGITAL AUX ↔ D-AUX NAME\*<sup>9</sup> ↔ AUX IN GAIN\*<sup>10</sup> ↔ POWER IC ↔ DEMO ↔ PLAY MODE

DISPLAY:

DIMMER ↔ SCROLL TYPE ↔ TEXT SCROLL ↔ DIMMER

IPOD:

PLAYLISTS ↔ ARTISTS ↔ ALBUMS ↔ PODCASTS ↔ AUDIOBOOKS ↔ GENRES ↔ COMPOSERS ↔ SONGS ↔ PLAYLISTS

TUNER:

FM LEVEL ↔ RDS REGIONAL\*<sup>11</sup> ↔ ALERT PTY31\*<sup>12</sup> ↔ PI SEEK\*<sup>13</sup> ↔ FM LEVEL

\*<sup>3</sup> If IMPRINT audio processor is connected, you can make more detailed settings for the audio setting. For details, refer to "IMPRINT Operation (Optional) (iDA-X303 only)" (page 26).

\*<sup>4</sup> Displayed only when an external audio processor is connected.

\*<sup>5</sup> Displayed only when MX is set to ON and an external audio processor is connected. (or the IMPRINT audio processor is connected (iDA-X303 only)).

\*<sup>6</sup> iDA-X303 only.

\*<sup>7</sup> Displayed only when BT IN is OFF.

\*<sup>8</sup> The setting can be made only when AUX+/AUX is set to ON.

\*<sup>9</sup> Displayed only when DIGITAL AUX is set to ON.

\*<sup>10</sup> Displayed only when AUX+ is set to ON.

\*<sup>11</sup> Refer to "Receiving RDS Regional (Local) Stations" (page 8).

\*<sup>12</sup> Refer to "Setting PTY31 (Emergency Broadcast) reception" (page 9).

\*<sup>13</sup> Refer to "PI SEEK Setting" (page 8).

### 4 Turn the Double Action encoder (iDA-X303 only) or Rotary encoder (iDA-X301/iDA-X301RR only) to change the setting, and then press **Q/ENTER**. (e.g. Select POWER IC ON or POWER IC OFF.)

### 5 Press and hold **↵** for 2 seconds to return to normal mode.

- Pressing **↵** during the procedure will return to the previous mode.
- If no operation is performed for 60 seconds, the unit will return to normal mode automatically.

## Bluetooth Setting

Select BT from the setup main menu in step 2 above.

If an optional Bluetooth INTERFACE (KCE-400BT) is connected, you can place a hands-free call by a Bluetooth- equipped mobile phone. Make this setting when the Bluetooth INTERFACE (KCE-400BT) is connected and the Bluetooth function is used. For details, refer to the Owner's Manual of the optional Bluetooth INTERFACE (KCE-400BT). Set ADPT when the Bluetooth INTERFACE (KCE-400BT) is connected.

- The **↵** button can be used only when an optional Bluetooth INTERFACE (KCE-400BT) is connected.
- If the mobile phone compatible with the Voice Dial function is connected, the Voice Dial function can be used.
- When INT MUTE is set to ON, the Bluetooth setting cannot be made. When the Bluetooth INTERFACE (KCE-400BT) is connected, set INT MUTE to OFF. Refer to "Turning Mute Mode On/Off (INT MUTE)" (page 24).

### Setting the Bluetooth Connection

**BT IN ADPT / BT IN OFF (Initial Setting)**

## Audio Setting (Only when external audio processor is connected)

AUDIO is selected on the setup menu in step 2.

### Operating the External Audio Processor (USER PRESET) PRE-1 (Initial Setting) / PRE-2 / PRE-3 / PRE-4 / PRE-5 / PRE-6

Turn the Double Action encoder (iDA-X303 only) or Rotary encoder (iDA-X301/iDA-X301RR only) to select the desired preset number, and then press **Q/ENTER**.

In normal mode, you can also call up the preset memory of the external audio processor by pressing and holding "PRESET" for at least 2 seconds. Refer to "Operating the External Audio Processor" on page 22.

- For the operation of external audio processor, refer to the Owner's Manual of the external audio processor you purchased.

### Turning Media Xpander ON/OFF

**OFF (Initial setting) / ON**

When the Media Xpander is on, and external audio processor is connected, you can adjust the Media Xpander level.

### Setting the MX Level

**NON EFFECT / LEVEL 1 / LEVEL 2 / LEVEL 3**

MX (Media Xpander) makes vocals or instruments sound distinct regardless of the music source. The FM radio, CD, USB memory and iPhone (iDA-X303 only)/iPod, will be able to reproduce the music clearly even in cars with a lot of road noise. The initial setting is different depending on the source.

### Subwoofer On and Off

**SUBW ON (Initial setting) / SUBW OFF**

The adjustment can also be made by pressing and holding IMPRINT\* (iDA-X303 only) or SOUND (iDA-X301/iDA-X301RR only) for at least 2 seconds. Refer to "Turning Subwoofer ON/OFF" (page 20).

- \* For iDA-X303, when connecting IMPRINT audio processor, you can't turn the subwoofer ON or OFF by pressing IMPRINT.

## General Setting

GENERAL is selected on the setup main menu in step 2.

### Connecting an MP3 Changer (PLAY MODE)

#### **CD-DA (Initial setting) / CD-DA&MP3**

Perform this setting when connecting MP3 changer. MP3 changer can playback CDs containing both CD and MP3 data. However, in some situations (some enhanced CDs), playback may be difficult. For these special cases, you can select playback of CD data only. When a disc contains both CD or the MP3 data, playback starts from the CD data portion of the disc.

- CD-DA :           Only CD data can be played back.  
CD-DA&MP3 :   Both CD data and MP3 file tracks can be played back.

- Change discs after performing this setting.

### Sound (Beep) Guide Function (iDA-X303 only)

#### **BEEP ON (Initial setting) / BEEP OFF**

This function will give audible feedback with varying tones depending upon the button pressed.

### Turning Mute Mode On/Off (INT MUTE)

#### **INT MUTE ON / INT MUTE OFF (Initial setting)**

If a device having the interrupt feature is connected, audio will be automatically muted whenever the interrupt signal is received from the device.

- When Bluetooth is set to ADPT, INT MUTE cannot be set. Refer to "Setting the Bluetooth Connection" (page 23).
- When the Bluetooth INTERFACE (KCE-400BT) is connected, set INT MUTE to OFF.

### Setting the AUX+ Mode

#### **AUX+ ON / AUX+ OFF (Initial setting)**

You can input the audio of a connected external device, (such as a portable player) to the Full Speed connector (iDA-X301/iDA-X301RR only)/Bluetooth interface connector (iDA-X303 only) of this unit, using a conversion cable (KCE-237B) (optional) for building up the AUX IN.

An external device and an iPod (iDA-X301/iDA-X301RR only)/Bluetooth INTERFACE (KCE-400BT) cannot be connected at the same time.

- AUX+ ON :   Set to ON when an external device is connected. If **⏻ SOURCE** is pressed and AUX+ is selected, the sound of the external device is input to the unit.  
AUX+ OFF :  Set to OFF when an iPod (iDA-X301/iDA-X301RR only) is connected. When set to OFF, AUX+ source cannot be selected.

### Setting the AUX+ NAME Mode

#### **AUX (Initial setting) / TV / DVD / PORTABLE / GAME**

You can change the AUX+ NAME when AUX+ is ON.

### Setting the AUX Mode (V-Link)

#### **AUX ON / AUX OFF (Initial setting)**

You can input TV/video sound by connecting an optional Ai-NET/RCA Interface cable (KCA-121B) or Versatile Link Terminal (KCA-410C) to this component.

You can change the AUX NAME display when AUX is set to ON. Press **Q/ENTER** when AUX is set to ON, and select AUX NAME by turning the **Double Action encoder** (iDA-X303 only) or **Rotary encoder** (iDA-X301/iDA-X301RR only), then press **Q/ENTER**. After that, turn the **Double Action encoder** (iDA-X303 only) or **Rotary encoder** (iDA-X301/iDA-X301RR only) to select the desired AUX name.

If the KCA-410C is connected, it is possible to select two AUX names.

- Via KCA-410C, up to 2 external devices with RCA output can be connected. In this case, press **⏻ SOURCE** to select AUX mode and then press **BAND/TA** to select your desired device.

### Setting the External Digital Input (DIGITAL AUX)

#### **DIGITAL AUX ON / DIGITAL AUX OFF (Initial setting)**

When an ALPINE Ai-NET compatible digital audio processor (PXA-H701) and a DVD player (DVE-5207) not compatible with Ai-NET are connected, set DIGITAL AUX to ON to enjoy 5.1-channel surround sound.

You can change the D-AUX Name when DIGITAL AUX is set to ON. Press **Q/ENTER** when DIGITAL AUX is set to ON, and select D-AUX NAME by turning **Double Action encoder** (iDA-X303 only) or **Rotary encoder** (iDA-X301/iDA-X301RR only), then press **Q/ENTER**.

- Press **⏻ SOURCE**, and select the D-AUX mode, and adjust the volume, etc.
- After input selection is completed, turn the ignition off and back on again. Setting of the optical digital input switch is completed.
- Depending on the connected audio processor, DVD player sound may continue to be output, even though the source is changed to another one. If this occurs, set the DVD player's power to OFF.

### Setting the AUX+ Level (AUX IN GAIN)

#### **LOW (Initial setting) / HI**

After setting to ON in "Setting the AUX+ Mode", this setting can be carried out.

- LOW: Decreases the external input audio level.  
HI:   Increases the external input audio level.

## Connecting to an External Amplifier (POWER IC)

### ON (Initial setting) / OFF

When an external amplifier is connected, sound quality can be improved by stopping the power supply of the built-in amplifier.

**POWER IC OFF :** Use this mode when the front pre-amplifier of the unit is used to drive an external amplifier connected to the speakers. In this setting, the head unit's internal amplifier has no output to drive speakers.

iDA-X303 :

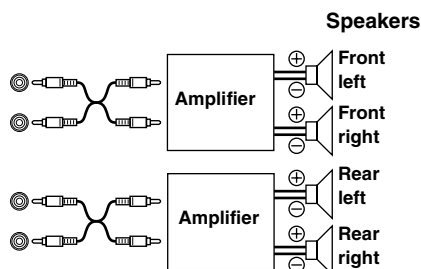

iDA-X301/iDA-X301RR :

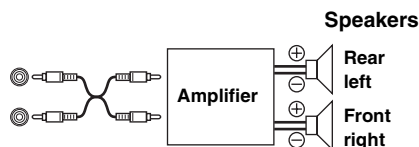

**POWER IC ON :** The speakers are driven by the built-in amplifier.

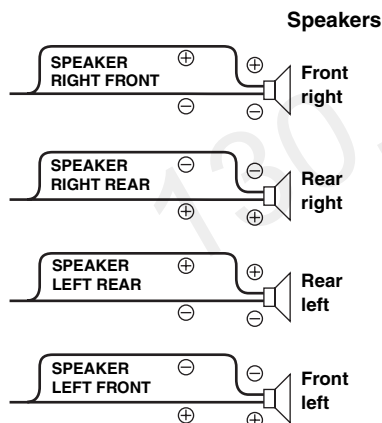

- No sound is produced by the system when the **POWER IC** is set to **OFF**.

## Demonstration

### DEMO ON / DEMO OFF (Initial setting)

This unit has a Demonstration feature for the display.

- To quit Demo mode, set to **DEMO OFF**.

## Display Setting

**DISPLAY** is selected on the setup main menu in step 2.

### Dimmer Control

#### MANUAL / AUTO (Initial setting)

Set the Dimmer control to **AUTO** to decrease the illumination brightness of the unit with the head lights of the vehicle **ON**. This mode is useful if you feel the unit's backlighting is too bright at night.

### Scroll Type Setting

#### TYPE1 / TYPE2 (Initial setting)

Choose from two scrolling methods.

Select the type you prefer.

- TYPE1:** The characters scroll from right to left, a single character at a time.
- TYPE2:** Words are built up from left to right, a single character at a time. When the display is filled, it is cleared and the remaining words are displayed the same way until all words of the title have been shown.

### Scroll Setting (TEXT SCROLL)

#### AUTO / MANUAL (Initial setting)

You can set a scroll type such as song title or file name on the source screen. If the search mode screen displays fills with text, the display scrolls.

- TEXT SCROLL AUTO :** Text information are scrolled automatically.
- TEXT SCROLL MANUAL :** The first display scrolls text information one time only.

- In parts of the display, scrolling may not occur, or scroll content may differ.
- Regardless of this setting, if the display is filled with text, the display scrolls.

## iPod Setting

**IPOD** is selected on the setup main menu in step 2.

### iPod Search Mode Setting

#### ON / OFF

The unit allows you to search for the iPhone (iDA-X303 only)/iPod using eight different search modes.

When the search mode is in **PLAYLISTS/ARTISTS/ALBUMS/PODCASTS/AUDIOBOOKS**, the initial setting is **ON**, and when the search mode is in **GENRES/COMPOSERS/SONGS**, the initial setting is **OFF**.

- For search mode details, refer to "Searching for a desired Song/ Title" (page 11).

## TUNER Setting

**TUNER** is selected on the setup main menu in step 2.

### Adjusting Source Signal Levels

#### FM LEVEL HI (Initial setting) / FM LEVEL LOW

If the difference in volume level between the iPod and FM radio is too great, adjust the FM signal level.

# IMPRINT Operation (Optional) (iDA-X303 only)

Alpine introduces IMPRINT - the world's first technology that thoroughly eliminates in-car acoustic problems that normally degrade sound quality, which enables us to experience music the way the artist intended, refer to "About IMPRINT" (page 33).

When the IMPRINT audio processor (PXA-H100) (sold separately) is connected to this unit, MultEQ and the following sound adjustment can be performed.

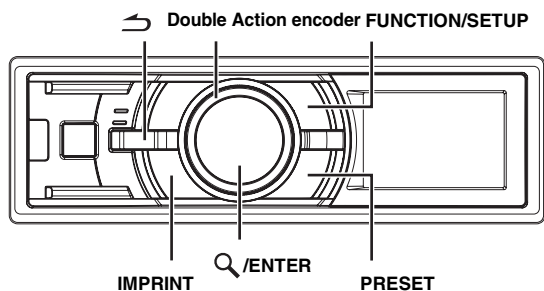

## Changing MultEQ mode

MultEQ, developed by Audyssey Labs, automatically corrects the audio for the listening environment. The system is optimized for selected positions in the vehicle. To accomplish this, MultEQ must take measurements of the vehicles response characteristics. For details on the set up procedure, consult your authorized Alpine dealer.

**1 Press and hold IMPRINT for at least 2 seconds.**

**2 Press Q/ENTER.**

**3 Turn the Double Action encoder to select the MultEQ mode, and then press Q/ENTER.**

OFF (Manual Mode) → CURVE 1 (MultEQ-1) →  
CURVE 2 (MultEQ-2) → OFF (Manual Mode)

**4 Press and hold IMPRINT for at least 2 seconds to return to normal mode.**

- The Curve mode can be selected only when curve 1 and curve 2 are stored.
- When using MultEQ, MX, X-OVER, Time Correction, Factory's EQ, SUBW PHASE, SUBW CHANNEL, TW Setup, EQ Mode, Filter Type, Parametric EQ and Graphic EQ are set automatically. They are no longer user adjustable.
- When an external audio processor is connected, the MultEQ function cannot be used.

## Adjusting Sound Setting in Manual Mode

You can change these sound settings to create your own preference when the MultEQ mode is set to MultEQ off (Manual Mode). However, subwoofer in the subwoofer system can be set to ON/OFF regardless of whether the MultEQ setting is ON or OFF.

**Use steps 1 to 5 to select one of the Sound menu modes to modify. See the applicable section below for details about the selected item.**

**1 Press and hold FUNCTION/SETUP for at least 2 seconds to activate the SETUP selection mode.**

**2 Turn the Double Action encoder to select AUDIO, and then press Q/ENTER.**

BT\*<sup>1</sup> ↔ AUDIO ↔ GENERAL ↔ DISPLAY ↔ IPOD ↔  
TUNER ↔ BT

\*<sup>1</sup> Displayed only when INT MUTE is set to OFF, and the mode is set to other than BT AUDIO.

**3 Turn the Double Action encoder to select the desired item, and then press Q/ENTER.**

USER PRESET ↔ MX ↔ FR-EQ ↔ SOUND FIELD\*<sup>2</sup> ↔  
SUBW ↔ SUBW SYS\*<sup>3</sup> ↔ SUBW PHASE\*<sup>3</sup> ↔  
SUBW CHANNEL\*<sup>3</sup> ↔ TW\*<sup>4</sup> ↔ EQ MODE ↔ FILTER ↔  
TCR ↔ MX LEVEL\*<sup>5</sup>  
(e.g. Select SUBW)

\*<sup>2</sup> In step 3, three sound adjustment items (PARAMETRIC EQ/ GRAPHIC EQ, TIME CORRECTION, X-OVER) can be selected in Sound Field Adjustment mode, turn the Double Action encoder to select the desired item, and then press Q/ENTER to continue to step 4.

\*<sup>3</sup> These functions are inoperable when Subwoofer is set to OFF.

\*<sup>4</sup> This function can be operable only when PXA-H100 (sold separately) is connected and 2.2ch (3WAY) mode is set. For details, refer to the Owner's Manual of PXA-H100.

\*<sup>5</sup> This function is inoperable when MX is set to OFF.

**4 Turn the Double Action encoder to change the setting, and then press Q/ENTER.**

(e.g. Select SUBW ON or SUBW OFF)

**5 Press and hold ↵ for at least 2 seconds to return to normal mode.**

- Media Xpander, Factory's EQ, Parametric EQ/Graphic EQ Adjustment, EQ Mode and MX Level Adjustment are inoperable when DEFEAT is set to ON.
- Pressing ↵ returns to the previous Sound menu mode.
- If no operation is performed for 60 seconds, Sound menu mode is cancelled.

## USER PRESET

- If *IMPRINT* audio processor is connected, you can make more detailed settings for the audio setting. For details, refer to “*IMPRINT Operation (Optional) (iDA-X303 only)*” (page 26).

### Storing the Audio Adjustment Level

You can store up to 3 adjusted/set contents on this unit.

All of the following adjusted/set items are stored in a preset memory.

Items to be adjusted/set	Reference page
EQ ADJ (Parametric EQ/Graphic EQ)	page 27 ~ page 28
TCR	page 28
X-OVER	page 28

**1 Turn the Double Action encoder to select a preset number, and press and hold Q/ENTER for at least 2 seconds.**

**2 Turn the Double Action encoder to select PROTECT YES/NO, and then press Q/ENTER to store the adjusted contents.**

PROTECT YES (Initial setting) ↔ PROTECT NO

- If *YES* is selected, the adjusted contents are protected and stored into the preset numbers. When you want to store the parameter into a protected preset number, “*REPLACE NO/YES*” can be selected.
- If *PROTECT NO* is selected, the preset is stored.
- While perform this operation, all adjusted contents of Parametric EQ/Graphic EQ, Time Correction and X-Over will be stored in the preset number.
- The stored contents are not deleted even when resetting the unit or disconnecting the battery.

### Recalling the Audio Adjustment Level

You can recall the contents stored in “Storing the Audio Adjustment Level” (page 27).

**1 Turn the Double Action encoder to select a preset number, and press Q/ENTER.**

Adjusted/set contents of the selected number are recalled.

- The User Preset screen can also be recalled in normal mode by pressing and holding **PRESET** for at least 2 seconds.

## Turning Media Xpander ON/OFF

When the Media Xpander is on, you can adjust the Media Xpander level (refer to page 30).

OFF (Initial setting) ↔ ON

## Equalizer Presets (Factory's EQ) (FR-EQ)

10 typical equalizer settings are preset at the factory for a variety of musical source material.

FLAT ↔ POPS ↔ ROCK ↔ NEWS ↔ JAZZ&BLUES ↔  
ELECTRICAL DANCE ↔ HIPHOP&RAP ↔  
EASY LISTENING ↔ COUNTRY ↔ CLASSICAL ↔ USER1 ↔  
USER2 ↔ USER3 ↔ USER4 ↔ USER5 ↔ USER6

- By selecting User's 1 to 6, you can recall the stored preset number in “Adjusting the Graphic Equalizer Curve” (page 28) or “Adjusting the Parametric Equalizer Curve” (page 27).

## Sound Field Adjustment

The setting of Parametric EQ/Graphic EQ Adjustment, Time Correction and X-Over can be adjusted in this mode.

### Adjusting the Parametric Equalizer Curve

You can modify the Equalizer settings to create a response curve more appealing to your personal taste. To adjust the Parametric Equalizer Curve, set the EQ mode to PARAMETRIC EQ. For details, refer to “Setting EQ mode” (page 30).

**1 After selecting EQ ADJ (Parametric EQ) from the Sound Field Adjustment mode, turn the Double Action encoder to select the band adjustment, and then press Q/ENTER.**

BAND1 → BAND2 → BAND3 → BAND4 → BAND5 → BAND1

**2 Turn the Double Action encoder to select an item to adjust, then press Q/ENTER.**

FC → LV → Q → FC  
(frequency) (level) (bandwidth) (frequency)

### Frequency Adjustment

**3-1 Turn the Double Action encoder to select frequency bands.**

Adjustable frequency bands:  
20 Hz to 20 kHz (in 1/3 octave steps)

BAND1: 20 Hz~80 Hz (63 Hz)  
BAND2: 50 Hz~200 Hz (150 Hz)  
BAND3: 125 Hz~3.2 kHz (400 Hz)  
BAND4: 315 Hz~8 kHz (1 kHz)  
BAND5: 800 Hz~20 kHz (2.5 kHz)

### Level Adjustment

**3-2 Turn the Double Action encoder to adjust the level.**

Adjustable level: -6 to +6 dB

### Bandwidth (Q) Adjustment

**3-3 Turn the Double Action encoder to set the bandwidth (Q).**

Adjustable bandwidth: 1, 1.5, 3

**4 To adjust another band, repeat steps 1 to 3 and adjust all bands.**

- The frequencies of adjacent bands cannot be adjusted within 4 steps.
- While adjusting the Parametric EQ, you should consider the frequency response of the connected speakers.
- You can select the next band by pressing and turning the **Double Action encoder**.
- The User Preset screen can be recalled in the normal mode by pressing and holding **PRESET** for 2 seconds.

## Adjusting the Graphic Equalizer Curve

You can modify the equalizer settings to create a response curve more appealing to your personal taste. To adjust the graphic equalizer curve, set the EQ mode to GRAPHIC EQ. For details, refer to “Setting EQ mode” (page 30).

### 1 After selecting EQ ADJ (Graphic EQ) from the Sound Field Adjustment mode, turn the Double Action encoder to select the band adjustment, and then press **Q/ENTER**.

BAND1 → BAND2 → BAND3 → BAND4 → BAND5 →  
BAND6 → BAND7 → BAND1

BAND-1 (63 Hz) / BAND-2 (150 Hz) / BAND-3 (400 Hz) /  
BAND-4 (1 kHz) / BAND-5 (2.5 kHz) / BAND-6 (6.3 kHz) /  
BAND-7 (17.5 kHz)

### 2 Press **Q/ENTER** to activate the level adjusting mode.

### 3 Turn the Double Action encoder to adjust the level.

Adjustable output level: -6 to +6 dB

### 4 To adjust another band, repeat steps 1 to 3, and then adjust all bands.

- You can select the next band by pressing and turning the Double Action encoder.
- The User Preset screen can be recalled in the normal mode by pressing and holding **PRESET** for 2 seconds.

## Adjusting the Time Correction

Before performing the following procedures, refer to “About Time Correction” (page 31).

### 1 After selecting TIME CORRECTION from the Sound Field Adjustment mode, turn the Double Action encoder to select the band adjustment, and then press **Q/ENTER**.

#### 2.2ch (3WAY) System

F-L (Initial setting) → F-R → R-L → R-R →  
(Mid-L) (Mid-R) (High-L) (High-R)  
SW-L → SW-R → F-L  
(Mid-L)

#### 4.2ch (FRONT/REAR/SUBW.) System

F-L (Initial setting) → F-R → R-L → R-R →  
(Front-L) (Front-R) (Rear-L) (Rear-R)  
SW-L → SW-R → F-L  
(Front-L)

### 2 Press **Q/ENTER** to activate the Time Correction input mode.

### 3 Turn the Double Action encoder to adjust the distance (0.0 to 336.6cm).

L = (distance to farthest speaker) – (distance to other speakers)

Refer to “Time Correction Value List” on page 31.

### 4 Repeat steps 1 to 3 to set another speaker.

By setting these values to make its sound reach the listening position at the same time as the sound of other speakers.

- You can select the next band by pressing and turning the Double Action encoder.
- The User Preset screen can be recalled in the normal mode by pressing and holding **PRESET** for 2 seconds.

## Adjusting the Crossover Settings (X-OVER)

Before performing the following procedures, refer to “About the Crossover” (page 32).

### 2.2ch (3WAY) System

### 1 After selecting X-OVER from the Sound Field Adjustment mode, turn the Double Action encoder to select the band adjustment, and then press **Q/ENTER**.

#### 2.2ch (3WAY) System / NORMAL (L=R)

##### Setting items:

LOW / MID-L / MID-H / HIGH

#### 2.2ch (3WAY) System / INDIVIDUAL (L/R)

##### Setting items:

LOW-L / LOW-R / MID-L-L / MID-L-R / MID-H-L /  
MID-H-R / HIGH-L / HIGH-R

### 2 Turn the Double Action encoder to select an item to adjust, then press **Q/ENTER**.

FC → LV → SLP → FC  
(cut-off frequency) (level) (slope) (frequency)

#### Cut-off frequency

### 3-1 Turn the Double Action encoder to select the desired cut-off frequency (Crossover Point).

Adjustable frequency bands:

#### 2.2ch (3WAY) System

##### Setting items:

LOW / MID-L 20 Hz~200 Hz  
MID-H 20 Hz~20 kHz  
HIGH (1 kHz~20 kHz)<sup>\*1</sup> / (20 Hz~20 kHz)<sup>\*2</sup>

<sup>\*1</sup> When **MAKER'S** is selected, refer to “Setting the Response Slope for the High Range Speaker (TW Setup)” (page 30).

<sup>\*2</sup> When **USER'S** is selected, refer to “Setting the Response Slope for the High Range Speaker (TW Setup)” (page 30).

#### Level Adjustment

### 3-2 Turn the Double Action encoder to adjust the output level.

Adjustable output level: -12 to 0 dB.

## Slope Adjustment

### 3-3 Turn the **Double Action encoder** to adjust the slope.

Adjustable slope: FLAT\*, 6 dB/oct., 12 dB/oct., 18 dB/oct., 24 dB/oct.

\* FLAT can be set for the HIGH slope only when USER'S is selected in "Setting the Response Slope for the High Range Speaker (TW Setup)" (page 30). Depending on the response characteristics of the speaker, care should be taken when setting the response slope to FLAT, as speaker damage may result. With this unit, a message is displayed when the response slope for the high range speaker is set to FLAT.

### 4 Repeat steps 1 to 3 to make adjustment to the other bands.

#### 4.2ch (FRONT/REAR/SUBW.) System

### 1 After selecting X-OVER from the Sound Field Adjustment mode, turn the **Double Action encoder** to select the band adjustment, and then press **Q/ENTER**.

#### 4.2ch (FRONT/REAR/SUBW.) System / NORMAL (L=R)

##### Setting items:

LOW (SUB-W) / MID (REAR) / HIGH (FRONT)

#### 4.2ch (FRONT/REAR/SUBW.) System / INDIVIDUAL (L/R)

##### Setting items:

LOW (SUB-W)-L / LOW (SUB-W)-R / MID (REAR)-L / MID (REAR)-R / HIGH (FRONT)-L / HIGH (FRONT)-R

### 2 Turn the **Double Action encoder** to select an item to adjust, then press **Q/ENTER**.

FC → LV → SLP → FC  
(cut-off frequency) (level) (slope) (frequency)

## Cut-off frequency

### 3-1 Turn the **Double Action encoder** to select the desired cut-off frequency (Crossover Point).

Adjustable frequency bands:

#### 4.2ch (FRONT/REAR/SUBW.) System

##### Setting items:

20 Hz~200 Hz

## Level Adjustment

### 3-2 Turn the **Double Action encoder** to adjust the output level.

Adjustable output level: -12 to 0 dB.

## Slope Adjustment

### 3-3 Turn the **Double Action encoder** to adjust the slope.

Adjustable slope: FLAT, 6 dB/oct., 12 dB/oct., 18 dB/oct., 24 dB/oct.

### 4 Repeat steps 1 to 3 to make adjustment to the other bands.

- You can select the next band by pressing and turning the **Double Action encoder**.
- While adjusting the X-OVER, you should consider the frequency response of the connected speakers.
- About the 2.2ch (3WAY)/4.2ch (FRONT/REAR/SUBW.) system You can switch to 2.2ch (3WAY)/4.2ch (FRONT/REAR/SUBW.) system mode with the 2.2ch (3WAY)/4.2ch (FRONT/REAR/SUBW.) switch on the PXA-H100. For details, refer to the Owner's Manual of PXA-H100.
- The User Preset screen can be recalled in the normal mode by pressing and holding **PRESET** for 2 seconds.

## Turning Subwoofer ON/OFF

When the subwoofer is on, you can adjust the subwoofer output level (refer to page 20).

OFF ↔ ON (Initial setting)

## Setting the Subwoofer System

When the subwoofer is on, you can select either SYS 1 or SYS 2 for the desired subwoofer effect.

1 (Initial setting) ↔ 2

SYS 1 : Subwoofer level changes according to the main volume setting.

SYS 2 : Subwoofer level change is different from the main volume setting. For example, even at low volume settings, the subwoofer is still audible.

## Setting the Subwoofer Phase

NORMAL (Initial setting) ↔ REVERSE

The subwoofer output phase is toggled SUBWOOFER NORMAL (0°) or SUBWOOFER REVERSE (180°). To adjust the level, turn the **Double Action encoder**.



## Setting the Subwoofer Channel (SUBW CHANNEL)

You can set the subwoofer output to stereo or monoaural. Make sure to set the correct output for your subwoofer type.

STEREO (Initial setting) ↔ MONO

STEREO: Subwoofer stereo (L/R) output

MONO: Subwoofer monoaural output

## Setting the Response Slope for the High Range Speaker (TW Setup)

Depending on the response characteristics of the speaker, care should be taken when setting the response slope of the high range speaker to FLAT in 2.2ch (3WAY) mode (see "Adjusting the Crossover Settings (X-OVER)" on page 28), as speaker damage may result.

MAKER'S (Initial setting) ↔ USER'S

MAKER'S: As protection from possible speaker damage, FLAT cannot be set for the response slope of the high range speaker in 2.2ch (3WAY) mode.

USER'S: The FLAT setting is possible in 2.2ch (3WAY) mode.

## Setting EQ mode

This setting gives you a choice of 5-band parametric, or 7-band graphic equalizer.

PARAMETRIC (Initial setting) ↔ GRAPHIC

## Setting the Filter type

NORMAL (Initial setting) ↔ INDIVIDUAL

NORMAL (L=R): Left and right speakers are adjusted equally.

INDIVIDUAL (L/R): Left and right speakers are individually adjusted.

## Setting the Time Correction Unit (TCR)

You can change the unit, (cm or inch) of time correction.

CM (Initial setting) ↔ INCH

## Setting the MX Level

MX (Media Xpander) makes vocals or instruments sound distinct regardless of the music source. The FM radio, CD, USB memory and iPod, will be able to reproduce the music clearly even in cars with a lot of road noise.

### Changing the source to which you want to apply Media Xpander.

#### FM (MX level 1 to 3):

The medium to high frequencies become clearer, and produces well balanced sound at all frequencies.

#### CD (MX level 1 to 3):

CD mode processes a large amount of data during playback. MX takes advantage of this large data quantity to reproduce a more clear, clean output.

#### CMPM (MX level 1 to 3):

This corrects information that was lost at the time of compression. This reproduces a well-balanced sound close to the original.

#### DVD (MX level 1 to 3):

A DVD or Video CD contains a large quantity of data such as music clip. MX uses this data to reproduce the sound accurately.

#### AUX (MX level 1):

Choose the MX mode (CMPM, MOVIE, or MUSIC) that corresponds to the media connected.

- The initial setting of MX is different depending on the source.
- Each music source, such as FM radio, CD, and MP3/WMA/AAC can have its own MX setting.
- On disks with both MP3/WMA/AAC and CD-DA, when the source changes from "MP3/WMA/AAC to CD-DA" or "CD-DA to MP3/WMA/AAC", MX-mode switching may delay playback slightly.
- Setting to Non Effect sets MX mode of each music source to OFF.
- The function is inoperable when DEFEAT is set to ON.
- There is no MX mode for MW and LW radio.
- If an audio processor with the MX function (PXA-H701, etc.) is connected, its own MX processing is applied to the music source. Since the processor MX settings may not match the head unit, the audio processor needs to be adjusted. For details, refer to the Owner's Manual of the audio processor.
- "CMPM" is applied for MP3/WMA/AAC and iPod.

## About Time Correction

The distance between the listener and the speakers in a car vary widely due to the complex speaker placement. This difference in the distances from the speakers to the listener creates a shift in the sounds image and frequency characteristics. This is caused by the time delay between the sound reaching the listener's right versus the left ear.

To correct this, this unit is able to delay the audio signal to the speakers closest to the listener. This effectively creates a perception of increased distance for those speakers. The listener can be placed at an equal distance between the left and right speakers for optimum staging. The adjustment will be made for each speaker in 3.4cm steps.

### Example 1. Listening Position: Front Left Seat

Adjust the time correction level of the front left speaker to a high value and the rear right to a low value.

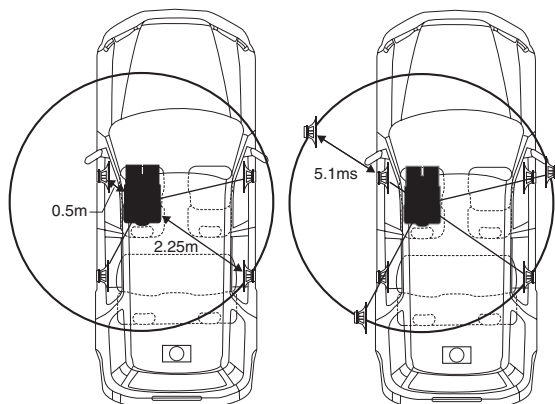

The sound is not balanced because the distance between the listening position and the various speakers is different. The difference in distance between the front left speaker and the rear right speaker is 1.75 m (68-7/8"). Here we calculate the time correction value for the front left speaker in the diagram on the above.

Conditions:

Farthest Speaker – listening position : 2.25 m (88-9/16")

Front left speaker – listening position : 0.5 m (19-11/16")

Calculation:  $L = 2.25\text{ m} - 0.5\text{ m} = 1.75\text{ m}$  (68-7/8")

Time correction =  $1.75 \div 343^{*1} \times 1,000 = 5.1$  (ms)

*\*1 Speed of sound: 343 m/s (765 mph) at 20°C*

In other words, giving the front left speaker a time correction value of 5.1 ms makes it seem as if its distance from the listener is the same as the distance to the farthest speaker.

Time correction eliminates the differences in the time required for the sound to reach the listening position.

The time of the front left speaker is corrected by 5.1 ms so that its sound reaches the listening position at the same time as the sound of other speakers.

### Example 2. Listening Position: All Seats

Adjust the time correction level of each speaker to almost the same level.

- 1** Sit in the listening position (driver's seat, etc.) and measure the distance (in meters) between your head and the various speakers.
- 2** Calculate the difference between the distance correction value to the farthest speaker and the other speakers.

$L = (\text{distance to farthest speaker}) - (\text{distance to other speakers})$

These values are the time correction values for the different speakers. Setting these values to make each sound reach the listening position at the same time as the sound of other speakers.

Time Correction Value List

Delay Number	Time Difference (ms)	Distance (cm)	Distance (inch)	Delay Number	Time Difference (ms)	Distance (cm)	Distance (inch)
0	0.0	0.0	0.0	51	5.1	173.4	68.3
1	0.1	3.4	1.3	52	5.2	176.8	69.7
2	0.2	6.8	2.7	53	5.3	180.2	71.0
3	0.3	10.2	4.0	54	5.4	183.6	72.4
4	0.4	13.6	5.4	55	5.5	187.0	73.7
5	0.5	17.0	6.7	56	5.6	190.4	75.0
6	0.6	20.4	8.0	57	5.7	193.8	76.4
7	0.7	23.8	9.4	58	5.8	197.2	77.7
8	0.8	27.2	10.7	59	5.9	200.6	79.1
9	0.9	30.6	12.1	60	6.0	204.0	80.4
10	1.0	34.0	13.4	61	6.1	207.4	81.7
11	1.1	37.4	14.7	62	6.2	210.8	83.1
12	1.2	40.8	16.1	63	6.3	214.2	84.4
13	1.3	44.2	17.4	64	6.4	217.6	85.8
14	1.4	47.6	18.8	65	6.5	221.0	87.1
15	1.5	51.0	20.1	66	6.6	224.4	88.4
16	1.6	54.4	21.4	67	6.7	227.8	89.8
17	1.7	57.8	22.8	68	6.8	231.2	91.1
18	1.8	61.2	24.1	69	6.9	234.6	92.5
19	1.9	64.6	25.5	70	7.0	238.0	93.8
20	2.0	68.0	26.8	71	7.1	241.4	95.1
21	2.1	71.4	28.1	72	7.2	244.8	96.5
22	2.2	74.8	29.5	73	7.3	248.2	97.8
23	2.3	78.2	30.8	74	7.4	251.6	99.2
24	2.4	81.6	32.2	75	7.5	255.0	100.5
25	2.5	85.0	33.5	76	7.6	258.4	101.8
26	2.6	88.4	34.8	77	7.7	261.8	103.2
27	2.7	91.8	36.2	78	7.8	265.2	104.5
28	2.8	95.2	37.5	79	7.9	268.6	105.9
29	2.9	98.6	38.9	80	8.0	272.0	107.2
30	3.0	102.0	40.2	81	8.1	275.4	108.5
31	3.1	105.4	41.5	82	8.2	278.8	109.9
32	3.2	108.8	42.9	83	8.3	282.2	111.2
33	3.3	112.2	44.2	84	8.4	285.6	112.6
34	3.4	115.6	45.6	85	8.5	289.0	113.9
35	3.5	119.0	46.9	86	8.6	292.4	115.2
36	3.6	122.4	48.2	87	8.7	295.8	116.6
37	3.7	125.8	49.6	88	8.8	299.2	117.9
38	3.8	129.2	50.9	89	8.9	302.6	119.3
39	3.9	132.6	52.3	90	9.0	306.0	120.6
40	4.0	136.0	53.6	91	9.1	309.4	121.9
41	4.1	139.4	54.9	92	9.2	312.8	123.3
42	4.2	142.8	56.3	93	9.3	316.2	124.6
43	4.3	146.2	57.6	94	9.4	319.6	126.0
44	4.4	149.6	59.0	95	9.5	323.0	127.3
45	4.5	153.0	60.3	96	9.6	326.4	128.6
46	4.6	156.4	61.6	97	9.7	329.8	130.0
47	4.7	159.8	63.0	98	9.8	333.2	131.3
48	4.8	163.2	64.3	99	9.9	336.6	132.7
49	4.9	166.6	65.7				
50	5.0	170.0	67.0				

# About the Crossover

## Crossover (X-OVER):

This unit is equipped with an active crossover. The crossover limits the frequencies delivered to the outputs. Each channel is controlled independently. Thus, each speaker pair can be driven by the frequencies for which they have been optimally designed.

The crossover adjusts the HPF (high pass filter) or LPF (low pass filter) of each band, and also the slope (how fast the filter rolls off the highs or lows).

Adjustments should be made according to the reproduction characteristics of the speakers. Depending on the speakers, a passive network may not be necessary. If you are unsure about this point, please consult your authorized Alpine dealer.

### 4.2ch (FRONT/REAR/SUB.W.) mode

	Cut-off frequency (1/3 octave steps)		Slope		Level
	HPF	LPF	HPF	LPF	
Low range speaker	----	20 Hz - 200 Hz	----	FLAT, 6, 12, 18, 24 dB/oct.	0 to -12 dB
Rear high range speaker	20 Hz - 200 Hz	----	FLAT, 6, 12, 18, 24 dB/oct.	----	0 to -12 dB
Front high range speaker	20 Hz - 200 Hz	----	FLAT, 6, 12, 18, 24 dB/oct.	----	0 to -12 dB

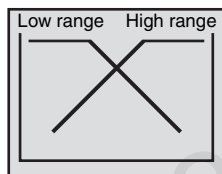

(Different from actual display)

### 2.2ch (3WAY) mode

	Cut-off frequency (1/3 octave steps)		Slope		Level
	HPF	LPF	HPF	LPF	
Low range speaker	----	20 Hz - 200 Hz	----	FLAT, 6, 12, 18, 24 dB/oct.	0 to -12 dB
Mid range speaker	20 Hz - 200 Hz	20 Hz - 20 kHz	FLAT, 6, 12, 18, 24 dB/oct.	FLAT, 6, 12, 18, 24 dB/oct.	0 to -12 dB
High range speaker	1 kHz - 20 kHz, (20 Hz ~ 20 kHz)*	----	FLAT* 6, 12, 18, 24 dB/oct.	----	0 to -12 dB

\* Only when selecting USER'S in "Setting the Response Slope for the High Range Speaker (TW Setup)" (page 30).

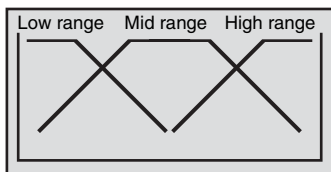

(Different from actual display)

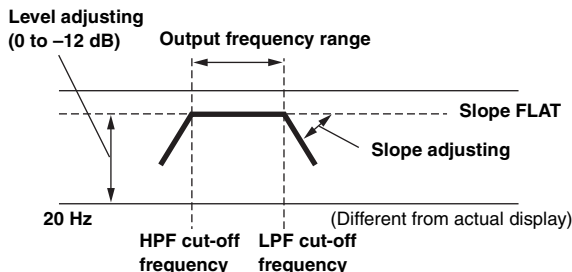

- **HPF (high pass filter):** Cuts the lower frequencies and allows the higher frequencies to pass.
  - **LPF (low pass filter):** Cuts the higher frequencies and allows the lower frequencies to pass.
  - **Slope:** The level change (in dB) for a frequency change of one octave.
  - The higher the slope value, the steeper the slope becomes.
  - Adjust the slope to FLAT to bypass the HP or LP filters.
  - Do not use a tweeter without the HPF on or set to a low frequency, as it may cause damage to the speaker due to the low frequency content.
  - You cannot adjust the crossover frequency higher than the HPF or lower than the LPF.
  - Adjustment should be made according to the recommended crossover frequency of the connected speakers. Determine the recommended crossover frequency of the speakers. Adjusting to a frequency range outside that recommended may cause damage to the speakers. For the recommended crossover frequencies of Alpine speakers, refer to the respective Owner's Manual.
- We are not responsible for damage or malfunction of speakers caused by using the crossover outside the recommended value.

## About IMPRINT



### VISION VS. REALITY

All good music starts as an artist's vision. After countless hours of rehearsing, recording and mixing, that vision is ready for us to hear on discs, radio and other media. But do we hear it as the artist created it? Unfortunately, the reality is that we are almost never able to listen to it in the exact way the artist intended. Especially when we are listening in a car.

### CARS ARE TERRIBLE LISTENING SPACES

Car interiors are full of materials that obstruct and degrade sound quality. For example, windows amplify and reflect high frequencies. Seat and dashboard coverings change certain frequencies. Carpets absorb and suppress mid frequencies. Graphic and parametric EQs are only partial remedies for these problems. In addition, the speakers are not located at equal distances from listeners, creating an unbalanced, uncentred sound stage. Time correction can help fix this, but only for one listening position.

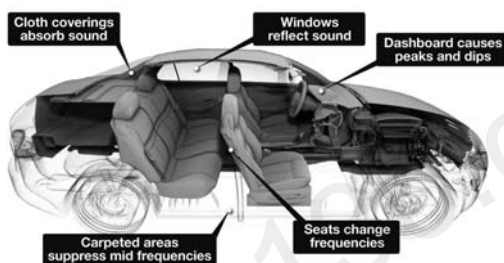

## INTRODUCING IMPRINT

These acoustical problems are so severe that no correction system has been able to overcome them. Until now, with the introduction of IMPRINT, Alpine provides a hardware/software combination that not only solves these problems, it actually improves the sound stage, tonal balance and definition - and does it automatically, in a matter of minutes!

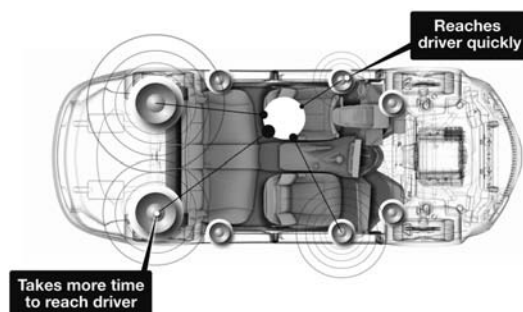

### HOW IMPRINT IS DIFFERENT

IMPRINT using MultEQ is superior to other equalisation systems in five ways.

- It is the only system that measures the entire listening area, capturing time domain information from each listening location and applying a proprietary method for processing it to represent all seat locations. This gives the people in each seat the optimal listening experience.
- It corrects both time and frequency problems, for an improved soundstage and smoother, more natural sound.
- It uses dynamic frequency allocation to apply hundreds of points of correction to those areas where the sound problems are greatest.
- It determines optimized blending points for low frequency crossovers.
- It provides, in minutes, vehicle sound tuning that generally takes skilled professionals days to accomplish.

# Information

## In Case of Difficulty

If you encounter a problem, please turn the power off, then on again. If the unit is still not functioning normally, please review the items in the following checklist. This guide will help you isolate the problem if the unit is at fault. Otherwise, make sure the rest of your system is properly connected or consult your authorized Alpine dealer.

### Basic

#### No function or display.

- Vehicle's ignition is off.
  - If connected following instructions, the unit will not operate with the vehicle's ignition off.
- Improper power lead (Red) and battery lead (Yellow) connections.
  - Check power lead and battery lead connections.
- Blown fuse.
  - Check the fuse of the unit; replace with the proper value if necessary.
- Internal micro-computer malfunctioned due to interference noise etc.
  - Press the RESET switch with a ball-point pen or other pointed article.

### Radio

#### Unable to receive stations.

- No antenna or open connection in cable.
  - Make sure the antenna is properly connected; replace the antenna or cable if necessary.

#### Unable to tune stations in the seek mode.

- You are in a weak signal area.
  - Make sure the tuner is in the DX mode.
- If the area you are in is a primary signal area, the antenna may not be grounded and connected properly.
  - Check your antenna connections; make sure the antenna is properly grounded at its mounting location.
- The antenna may not be the proper length.
  - Make sure the antenna is fully extended; if broken, replace the antenna with a new one.

#### Broadcast is noisy.

- The antenna is not the proper length.
  - Extend the antenna fully; replace it if it is broken.
- The antenna is poorly grounded.
  - Make sure the antenna is grounded properly at its mounting location.

### MP3/WMA/AAC

#### MP3, WMA or AAC is not played back.

- Writing error occurred. The MP3/WMA/AAC format is not compatible.
  - Make sure the MP3/WMA/AAC has been written in a supported format. Refer to "About MP3/WMA/AAC" (pages 18-19), then rewrite in the format supported by this device.

### Audio

#### The sound is not output from the speakers.

- Unit has no output signal of the internal amplifier.
  - POWER IC is switched to "ON" (page 25).

### iPod

#### iPod does not play and no sound is output.

- The iPod has not been recognized.
  - Reset this unit and the iPod. Refer to "Initial System Start-Up" (page 6). To reset the iPod, refer to the Owner's Manual of the iPod.

### Indication for iPod Mode

#### (USB connection), (iDA-X303 only)

#### CURRENT ERROR

- Abnormal current is being drawn by the device connected to USB. An error message may be displayed if the device connected is not compatible or defective.
  - Attempt to connect another iPhone/iPod.

#### DEVICE ERROR

- An iPod that is not supported by the unit is connected.
  - Connect an iPod that is supported by the unit.

#### NO USB DEVICE

- An iPhone/iPod is not connected.
  - Make sure the iPhone/iPod is correctly connected and the cable is not excessively bent.

#### NO SONG

- There are no songs in the iPhone/iPod.
  - Download songs to the iPhone/iPod and connect to this unit.

#### NO SUPPORT

- Text information that is not supported on the unit has been input.
  - Use an iPhone/iPod in which text information is input that is supported on the unit.

#### ERROR-01

- Communication error.
  - Turn the ignition key off, and then set to ON again.
  - Reset the iPod.
  - Verify in the display after reconnecting the iPhone/iPod to the Interface cable for iPod and to the USB cable.

---

### ERROR-02

- Caused by the iPhone/iPod Software Version not being compatible with this unit.
    - Update the iPhone/iPod Software Version to be compatible with this unit.
- 

### ERROR-03

- The iPod is not verified.
    - Try another iPod.
- 

### Indication for iPod Mode (Direct Connection), (iDA-X301/ iDA-X301RR only)

#### NO IPOD

- The iPod is not connected.
    - Make sure the iPod is correctly connected (refer to "Connections").
    - Make sure the cable is not bent excessively.
- 

#### NO SONG

- There are no songs in the iPod.
    - Download songs to the iPod and connect to this unit.
- 

### ERROR-01

- Communication error.
    - Turn the ignition key off, and then set to ON again.
    - Reset the iPod.
    - Check the display by reconnecting between the iPod and this unit using the FULL SPEED™ Connection Cable (KCE-433iV).
- 

### ERROR-02

- Caused by the iPod Software Version not being compatible with this unit.
    - Update the iPod Software Version to be compatible with this unit.
- 

### Indication for USB memory

#### CURRENT ERROR

- Abnormal current is run to the USB connector device (an error message may be displayed if the USB device that is not compatible with the unit is connected).
    - USB memory is a malfunction or it is shorted.
    - Connect another USB Flash Memory device.
- 

#### DEVICE ERROR

- A USB device that is not supported by the unit is connected.
    - Connect a USB device that is supported by the unit.
- 

#### NO USB DEVICE

- A USB memory is not connected.
    - Make sure the USB memory device is correctly connected and the cable is not excessively bent.
- 

### NO SONG

- No song (file) is stored in the USB memory.
    - Connect the USB memory device after storing songs (files).
- 

### UNSUPPORT

- A sampling rate/bit rate not supported by the unit is used.
    - Use a sampling rate/bit rate that is supported by the unit.
- 

### PROTECT

- A copy-protected WMA file was played back.
    - You can only play back non-copy-protected files.
- 

### NO SUPPORT

- Text information that is not recognizable by the unit has been input.
    - Use a USB memory device with input text information that is supported by the unit.
- 

### Indication for Portable audio player Mode (iDA-X303 only)

#### CURRENT ERROR

- Abnormal current is being drawn by the device connected to USB. An error message may be displayed if the device connected is not compatible. The USB Flash Memory device may be defective.
    - Attempt to connect another Portable audio player.
- 

#### DEVICE ERROR

- A Portable audio player that is not supported by the unit is connected.
    - Attempt to connect another Portable audio player.
- 

#### NO USB DEVICE

- A Portable audio player is not connected.
    - Make sure the Portable audio player is correctly connected and the cable is not excessively bent.
- 

### NO SONG

- There are no songs in the Portable audio player.
    - Download songs to the Portable audio player and connect to this unit.
- 

### NO SUPPORT

- Text information that is no supported on the unit has been input.
    - Use a Portable audio player in which text information is input that is supported on the unit.
-

---

## ERROR-01

- Communication error.
    - Turn the ignition key off, and then set to ON again.
    - Verify in the display after reconnecting the Portable audio player to the connection cable.
- 

## ERROR-02

- Caused by the Software Version not being compatible with this unit.
    - Update the Portable audio player Software Version.
- 

## ERROR-03

- The Portable audio player is not verified.
    - Change another Portable audio player.
- 

## Indication for CD Changer

### HI-TEMP

- Protective circuit is activated due to high temperature.
    - The indication will disappear when the temperature returns to normal operating range.
- 

## ERROR-01

- Malfunction in the CD Changer.
    - Consult your Alpine dealer. Press the magazine eject button and pull out the magazine. Check the indication. Insert the magazine again. If the magazine cannot be pulled out, consult your Alpine dealer.
  - Magazine ejection not possible.
    - Press the magazine eject button. If the magazine does not eject, consult your Alpine dealer.
- 

## ERROR-02

- A disc is left inside the CD Changer.
    - Press the eject button to activate the eject function. When the CD Changer finishes the eject function, insert an empty CD magazine into the CD Changer to receive the disc left inside the CD Changer.
- 

## NO MAGAZINE

- No magazine is loaded into the CD Changer.
    - Insert a magazine.
- 

## NO DISC

- No indicated disc.
    - Choose another disc.
-

## Specifications

### FM TUNER SECTION

Tuning Range	87.5-108.0 MHz
Mono Usable Sensitivity	0.7 $\mu$ V
Alternate Channel Selectivity	80 dB
Signal-to-Noise Ratio	65 dB
Stereo Separation	35 dB
Capture Ratio	2.0 dB

### MW TUNER SECTION

Tuning Range	531-1,602 kHz
Sensitivity (IEC Standard)	25.1 $\mu$ V/28 dB

### LW TUNER SECTION

Tuning Range	153-281 kHz
Sensitivity (IEC Standard)	31.6 $\mu$ V/30 dB

### USB SECTION

USB requirements	USB 1.1/2.0
Max. Power Consumption	500mA
USB Class	Mass Storage
File System	FAT 12/16/32
MP3 Decoding	MPEG-1/2 AUDIO Layer-3
WMA Decoding	Windows Media™ Audio
AAC Decoding	AAC-LC format “.m4a” file
Number of Channels	2-Channel (Stereo)
Frequency Response*	5-20,000 Hz ( $\pm$ 1 dB)
Total Harmonic Distortion	0.008% (at 1 kHz)
Dynamic Range	95 dB (at 1 kHz)
Signal-to-Noise Ratio	>105 dB
Channel Separation	85 dB (at 1 kHz)

\* Frequency response may differ depending on the encoder software/bit rate.

### GENERAL

Power Requirement	14.4 V DC (11-16 V allowable)
Maximum Power Output	45 W $\times$ 4
Maximum Pre-Output Voltage	2 V/10 k ohms
Bass	$\pm$ 14 dB at 100 Hz
Treble	$\pm$ 14 dB at 10 kHz
Weight	1.0 kg (2 lbs. 3 oz)

### CHASSIS SIZE

Width	178 mm (7")
Height	50 mm (2")
Depth	156 mm (6-1/8")

### NOSEPIECE SIZE

Width	
iDA-X303	170 mm (6-3/4")
iDA-X301/iDA-X301RR	170 mm (6-3/4")
Height	
iDA-X303	46 mm (1-13/16")
iDA-X301/iDA-X301RR	46 mm (1-13/16")
Depth	
iDA-X303	28 mm (1-1/8")
iDA-X301/iDA-X301RR	27 mm (1-1/16")

- Due to continuous product improvement, specifications and design are subject to change without notice.



# Installation and Connections

Before installing or connecting the unit, please read the following and pages 3 and 4 of this manual thoroughly for proper use.

## Warning

### **MAKE THE CORRECT CONNECTIONS.**

Failure to make the proper connections may result in fire or product damage.

### **USE ONLY IN CARS WITH A 12 VOLT NEGATIVE GROUND.**

(Check with your dealer if you are not sure.) Failure to do so may result in fire, etc.

### **BEFORE WIRING, DISCONNECT THE CABLE FROM THE NEGATIVE BATTERY TERMINAL.**

Failure to do so may result in electric shock or injury due to electrical shorts.

### **DO NOT SPLICE INTO ELECTRICAL CABLES.**

Never cut away cable insulation to supply power to other equipment. Doing so will exceed the current carrying capacity of the wire and result in fire or electric shock.

### **DO NOT DAMAGE PIPE OR WIRING WHEN DRILLING HOLES.**

When drilling holes in the chassis for installation, take precautions so as not to contact, damage or obstruct pipes, fuel lines, tanks or electrical wiring. Failure to take such precautions may result in fire.

### **DO NOT USE BOLTS OR NUTS IN THE BRAKE OR STEERING SYSTEMS TO MAKE GROUND CONNECTIONS.**

Bolts or nuts used for the brake or steering systems (or any other safety-related system), or tanks should NEVER be used for installations or ground connections. Using such parts could disable control of the vehicle and cause fire etc.

### **KEEP SMALL OBJECTS SUCH AS BOLTS OR SCREWS OUT OF THE REACH OF CHILDREN.**

Swallowing them may result in serious injury. If swallowed, consult a physician immediately.

### **DO NOT INSTALL IN LOCATIONS WHICH MIGHT HINDER VEHICLE OPERATION, SUCH AS THE STEERING WHEEL OR SHIFT LEVEL.**

Doing so may obstruct forward vision or hamper movement etc. and results in serious accident.

### **DO NOT ALLOW CABLES TO BECOME ENTANGLED IN SURROUNDING OBJECTS.**

Arrange wiring and cables in compliance with the manual to prevent obstructions when driving. Cables or wiring that obstruct or hang up on places such as the steering wheel, shift lever, brake pedals, etc. can be extremely hazardous.

## Caution

### **HAVE THE WIRING AND INSTALLATION DONE BY EXPERTS.**

The wiring and installation of this unit requires special technical skill and experience. To ensure safety, always contact the dealer where you purchased this product to have the work done.

### **USE SPECIFIED ACCESSORY PARTS AND INSTALL THEM SECURELY.**

Be sure to use only the specified accessory parts. Use of other than designated parts may damage this unit internally or may not securely install the unit in place. This may cause parts to become loose resulting in hazards or product failure.

### **ARRANGE THE WIRING SO IT IS NOT CRIMPED OR PINCHED BY A SHARP METAL EDGE.**

Route the cables and wiring away from moving parts (like the seat rails) or sharp or pointed edges. This will prevent crimping and damage to the wiring. If wiring passes through a hole in metal, use a rubber grommet to prevent the wire's insulation from being cut by the metal edge of the hole.

### **DO NOT INSTALL IN LOCATIONS WITH HIGH MOISTURE OR DUST.**

Avoid installing the unit in locations with high incidence of moisture or dust. Moisture or dust that penetrates into this unit may result in product failure.

## Precautions

- Be sure to disconnect the cable from the (-) battery post before installing your iDA-X303/iDA-X301/iDA-X301RR. This will reduce any chance of damage to the unit in case of a short-circuit.
- Be sure to connect the colour coded leads according to the diagram. Incorrect connections may cause the unit to malfunction or damage to the vehicle's electrical system.
- When making connections to the vehicle's electrical system, be aware of the factory installed components (e.g. on-board computer). Do not tap into these leads to provide power for this unit. When connecting the iDA-X303/iDA-X301/iDA-X301RR to the fuse box, make sure the fuse for the intended circuit of the iDA-X303/iDA-X301/iDA-X301RR has the appropriate amperage. Failure to do so may result in damage to the unit and/or the vehicle. When in doubt, consult your Alpine dealer.
- The iDA-X303/iDA-X301/iDA-X301RR uses female RCA-type jacks for connection to other units (e.g. amplifier) having RCA connectors. You may need an adaptor to connect other units. If so, please contact your authorized Alpine dealer for assistance.
- Be sure to connect the speaker (-) leads to the speaker (-) terminal. Never connect left and right channel speaker cables to each other or to the vehicle body.

#### **IMPORTANT**

Please record the serial number of your unit in the space provided below and keep it as a permanent record. The serial number or the engraved serial number is located on the bottom of the unit.

SERIAL NUMBER: \_\_\_\_\_

INSTALLATION DATE: \_\_\_\_\_

INSTALLATION TECHNICIAN: \_\_\_\_\_

PLACE OF PURCHASE: \_\_\_\_\_

# Installation

## Caution

Do not block the unit's heat sink, thus preventing air circulation. If blocked, heat will accumulate inside the unit and may cause a fire.

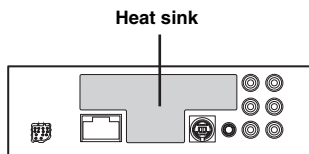

\* The illustrator is for iDA-X303.

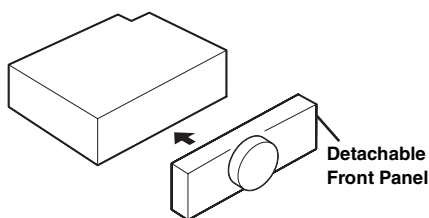

## Caution

When you install this unit in your car, do not remove the detachable front panel. If the detachable front panel is removed during installation, you might press too hard and warp the metal plate that holds it in place.

- The main unit must be mounted within 35 degrees of the horizontal plane, back to front.

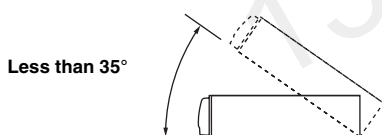

1

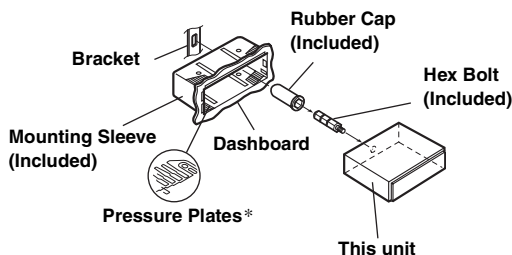

\* If the installed mounting sleeve is loose in the main unit, the pressure plates may be bent slightly to remedy the problem.

Remove the mounting sleeve from the main unit (see "Removal" on page 39). Slide the mounting sleeve into the dashboard and fix it with the metal shackles.

2

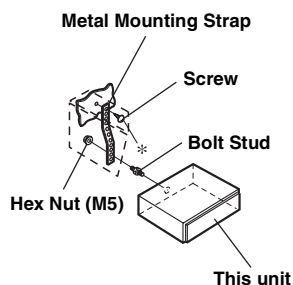

When your vehicle has the Bracket, mount the long hex bolt onto the rear panel of the iDA-X303/iDA-X301/iDA-X301RR and put the Rubber Cap on the hex bolt. If your vehicle does not have the Mounting Support, reinforce the head unit with the metal mounting strap (not supplied). Connect all the leads of the iDA-X303/iDA-X301/iDA-X301RR according to details described in the CONNECTIONS section.

- For the screw \*, provide a proper screw to the chassis installing location.

3

Slide the iDA-X303/iDA-X301/iDA-X301RR into the dashboard. When the unit is in place, make sure the locking pins are fully seated in the down position. This can be done by pressing firmly in on the unit while pushing the locking pin down with a small screwdriver. This ensures that the unit is properly locked and will not accidentally come out from the dashboard. Install the detachable front panel.

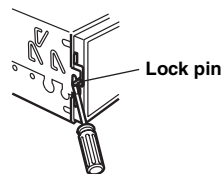

## Removal

- Remove the detachable front panel.
- Use a small screwdriver (or similar tool) to push the locking pins to the "up" position (see above drawing). As each pin is unlocked, gently pull out on the unit to make sure it does not re-lock before unlocking the second pin.

Pull the unit out, keeping it unlocked as you do so.

## <JAPANESE CAR>

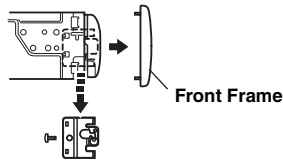

Front Frame

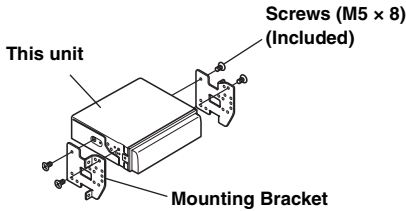

### iPod Connection (sold separately)

#### **USB connection (iDA-X303 only)**

Connect USB cable to an iPhone (iDA-X303 only)/iPod with Interface cable for iPod.

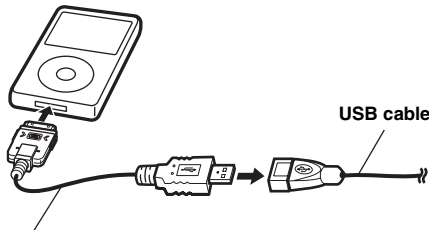

Interface cable for iPod (supplied, iDA-X303 only)

#### **Direct connection**

Connect iPod direct connector to an iPod with FULL SPEED™ connection cable (KCE-433iV).

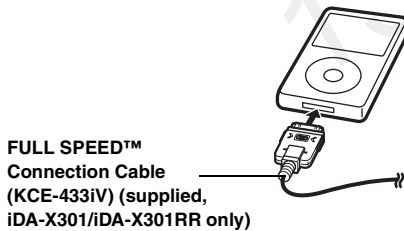

FULL SPEED™ Connection Cable (KCE-433iV) (supplied, iDA-X301/iDA-X301RR only)

### **Remove the iPod**

Remove the iPod from FULL SPEED™ Connection Cable (or Interface cable for iPod (iDA-X303 only)).

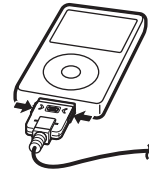

- Remove the iPhone/iPod after the unit has been changed to a source other than the iPhone/iPod. If the iPhone/iPod is removed while playing, data may be lost.
- If sound is not output or the iPhone/iPod is not recognized even when the iPod is connected, remove the iPhone/iPod once, then connect it again, or reset the iPod.
- Do not leave the iPhone/iPod in a vehicle for a long time. Heat and humidity may damage the iPhone/iPod and you may not be able to play it again.

### USB memory Connection (sold separately)

#### **Connect USB memory**

1. Connect the USB cable to the USB connector of the unit, and then secure the connection using the lock case supplied with USB cable as shown below.

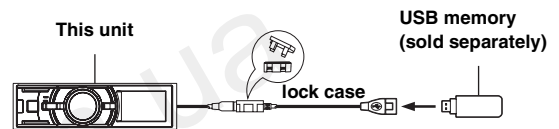

2. Connect USB memory to USB cable.

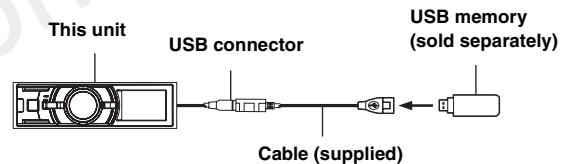

#### **Remove USB memory**

Pull out USB memory squarely from the USB cable.

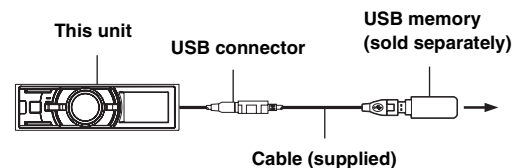

- When removing USB memory, pull it out straight.
- If sound is not output or USB memory is not recognized even when USB memory is connected, remove USB memory once, then connect it again.
- Change to a source other than the USB memory mode, then remove the USB memory. If the USB memory is removed in the USB memory mode, data may be damaged.
- Route the USB cable away from other cables.

### Portable Audio Player Connection (sold separately, iDA-X303 only)

#### **Connecting a Portable audio player**

Connect the cable supplied with a Portable audio player to the USB cable.

Disconnect the Portable audio player.

Disconnect the cable supplied with the Portable audio player from the USB cable.

- Refer also to the Owner's Manual of the Portable audio player.

# Connections

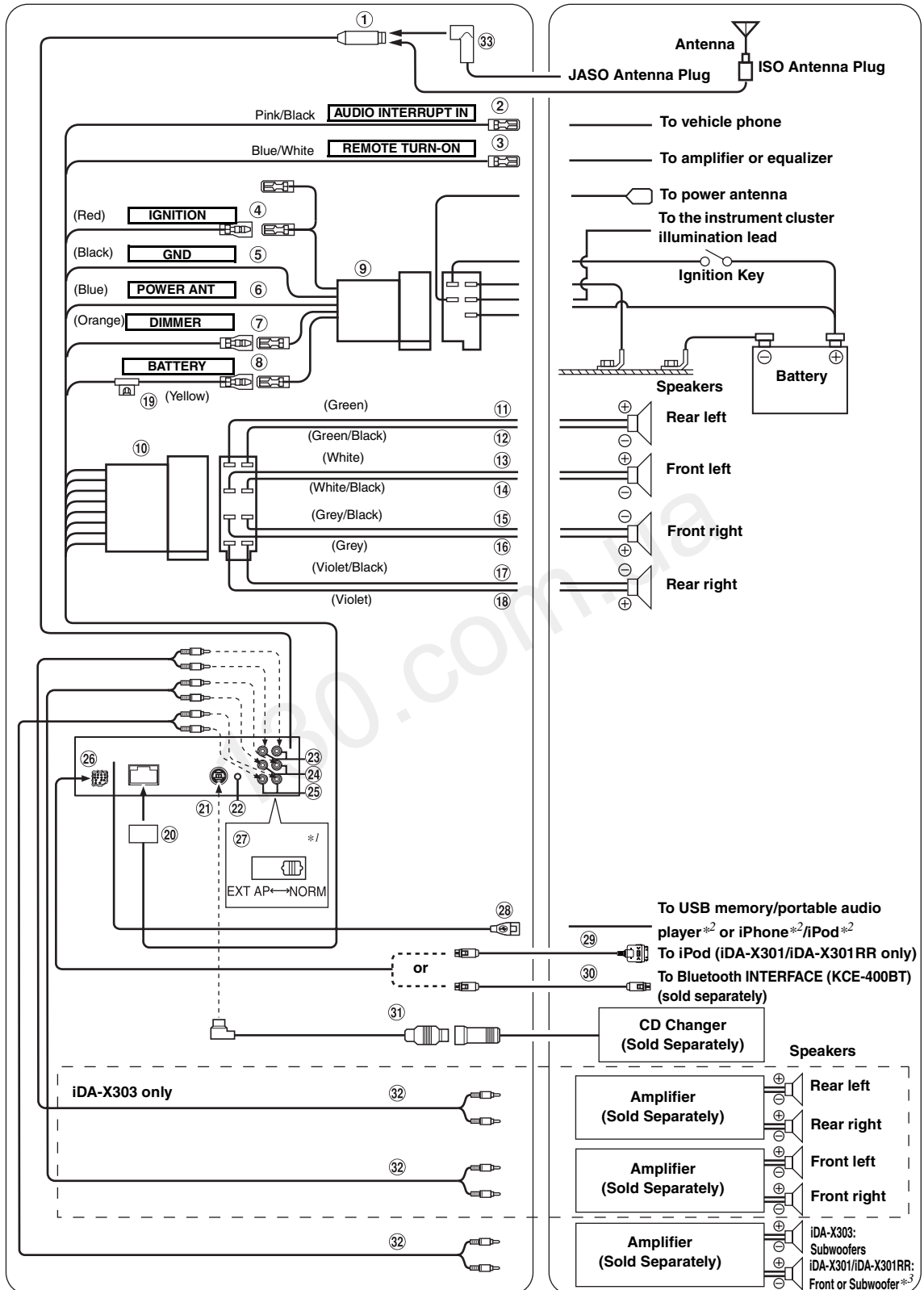

<sup>\*1</sup> The system switch is located on the bottom of the unit.

<sup>\*2</sup> iDA-X303 only.

<sup>\*3</sup> When Subwoofer is OFF: Output is for Front speakers. When Subwoofer is ON: Output is for Subwoofer. For details on how to set the Subwoofer to ON/OFF, see "Turning Subwoofer ON/OFF" on page 20.

- ① **Antenna Receptacle**
- ② **Audio Interrupt In Lead (Pink/Black)**  
Connect this lead to the Audio Interface output of a cellular phone which provides ground shorting when a call is received.
- ③ **Remote Turn-On Lead (Blue/White)**  
Connect this lead to the remote turn-on lead of your amplifier or signal processor.
- ④ **Switched Power Lead (Ignition) (Red)**  
Connect this lead to an open terminal on the vehicle's fuse box or another unused power source which provides (+) 12V only when the ignition is turned on or in the accessory position.
- ⑤ **Ground Lead (Black)**  
Connect this lead to a good chassis ground on the vehicle. Make sure the connection is made to bare metal and is securely fastened using the sheet metal screw provided.
- ⑥ **Power Antenna Lead (Blue)**  
Connect this lead to the +B terminal of your power antenna, if applicable.
- *This lead should be used only for controlling the vehicle's power antenna. Do not use this lead to turn on an amplifier or a signal processor, etc.*
- ⑦ **Dimmer Lead (Orange)**  
This lead may be connected to the vehicle's instrument cluster illumination lead. This will enable the vehicle's dimmer control to dim the backlighting of the unit.
- ⑧ **Battery Lead (Yellow)**  
Connect this lead to the positive (+) post of the vehicle's battery.
- ⑨ **ISO Power Supply Connector**
- ⑩ **ISO Connector (Speaker Output)**
- ⑪ **Left Rear (+) Speaker Output Lead (Green)**
- ⑫ **Left Rear (-) Speaker Output Lead (Green/Black)**
- ⑬ **Left Front (+) Speaker Output Lead (White)**
- ⑭ **Left Front (-) Speaker Output Lead (White/Black)**
- ⑮ **Right Front (-) Speaker Output Lead (Grey/Black)**
- ⑯ **Right Front (+) Speaker Output Lead (Grey)**
- ⑰ **Right Rear (-) Speaker Output Lead (Violet/Black)**
- ⑱ **Right Rear (+) Speaker Output Lead (Violet)**
- ⑲ **Fuse Holder (10A)**
- ⑲ **Power Supply Connector**
- ⑲ **Ai-NET Connector**  
Connect this to the output or input connector of another device (CD Changer, Equalizer, etc.) equipped with Ai-NET.
- *Be sure to set "Setting the Connected Head Unit (MODEL SETUP)" to "CD CHG", when the DHA-S690 is connected.*
- *Interface adapter for iPod (KCA-420i) is not recommended for use with this product.*
- ⑲ **Steering Remote Control Interface Connector**  
To steering remote control interface box.
- ⑲ **Rear Output/Input RCA Connectors (iDA-X303 only)**  
It can be used as Rear Output or Input RCA Connectors. RED is right and WHITE is left.
- ⑲ **Front Output/Input RCA Connectors (iDA-X303 only)**  
It can be used as Front Output or Input RCA Connectors. RED is right and WHITE is left.
- ⑲ **Subwoofer Output RCA Connectors (iDA-X303 only)**
- ⑲ **Front/Subwoofer Output RCA Connectors (iDA-X301/iDA-X301RR only).**  
RED is right and WHITE is left.
- ⑲ **Bluetooth interface Connector (iDA-X303 only)**  
Connect this to an optional Bluetooth INTERFACE (KCE-400BT). To use a hands-free mobile phone, an optional Bluetooth INTERFACE (KCE-400BT) connection is required. For details on connection, refer to the Owner's Manual of the Bluetooth INTERFACE (KCE-400BT). You can also connect this to an external device (such as a portable player) by using a conversion cable (KCE-237B) (sold separately) for building up the AUX IN.
- *Refer to "Setting the AUX+ Mode" (page 24).*  
AUX+ ON : When the external device is connected.  
AUX+ OFF : When set to OFF, AUX+ source cannot be selected.
- ⑲ **Full Speed Connector (iDA-X301/iDA-X301RR only)**  
Control iPod signals.  
Connect this to an iPod or to an optional Bluetooth INTERFACE (KCE-400BT). To use a hands-free mobile phone, an optional Bluetooth INTERFACE (KCE-400BT) connection is required. For details on connection, refer to the Owner's Manual of the Bluetooth INTERFACE (KCE-400BT). You can also connect this to an external device (such as a portable player) by using a conversion cable (KCE-237B) (sold separately) for building up the AUX IN.
- *Refer to "Setting the AUX+ Mode" (page 24).*  
AUX+ ON : When the external device is connected.  
AUX+ OFF : When an iPod is connected.
- ⑲ **System Switch**  
When connecting a processor or divider using Ai-NET, place this switch in the EXT AP position. When no device is connected, leave the switch in the NORM position.  
iDA-X303 only:  
When switched to NORM, the RCA Connectors ⑲ and ⑲ can be used as Output RCA Connectors.  
When switched to EXT AP, the RCA Connectors ⑲ and ⑲ can be used as Input RCA Connectors.
- *Be sure to turn the power off to the unit before changing the switch position.*
- ⑲ **USB Connector**  
Connect this to an USB memory/portable audio player\* or iPhone\*/iPod\*. To use an iPhone/iPod, Interface cable for iPod connection is required (iDA-X303 only).
- \* *iDA-X303 only.*
- *Use the supplied USB cable. If a USB cable other than the supplied is used, correct performance cannot be guaranteed.*
- *Route the USB cable away from other cables.*
- ⑲ **FULL SPEED™ Connection Cable (KCE-433iV) (supplied, iDA-X301/iDA-X301RR only)**
- ⑲ **KCE-400BT Connection Cable (Included with KCE-400BT)**
- ⑲ **Ai-NET Cable (Included with CD Changer)**
- ⑲ **RCA Extension Cable (sold separately)**
- ⑲ **ISO/JASO Antenna Adaptor (sold separately)**  
An ISO/JASO antenna adaptor may be required, depending on the vehicle.

#### To prevent external noise from entering the audio system.

- Locate the unit and route the leads at least 10 cm away from the car harness.
- Keep the battery power leads as far away from other leads as possible.
- Connect the ground lead securely to a bare metal spot (remove any paint, dirt or grease if necessary) of the car chassis.
- If you add an optional noise suppressor, connect it as far away from the unit as possible. Your Alpine dealer carries various noise suppressors, contact them for further information.
- Your Alpine dealer knows best about noise prevention measures so consult your dealer for further information.