



PHONES

(044) 360-7-130
 (050) 336-0-130
 (063) 788-0-130
 (067) 233-0-130
 (068) 282-0-130

130 Internet store of autogoods

COM.UA



ICQ
 294-0-130
 597-0-130

SKYPE
 km-130

CAR RECEIVERS — Receivers • Media receivers and stations • Native receivers • CD/DVD changers • FM-modulators/USB adapters • Flash memory • Facia plates and adapters • Antennas • Accessories |
 CAR AUDIO — Car audio speakers • Amplifiers • Subwoofers • Processors • Crossovers • Headphones • Accessories | TRIP COMPUTERS — Universal computers • Model computers • Accessories |
 GPS NAVIGATORS — Portable GPS • Built-in GPS • GPS modules • GPS trackers • Antennas for GPS navigators • Accessories | VIDEO — DVR • TV sets and monitors • Car TV tuners • Cameras • Videomodules
 • Transcoders • Car TV antennas • Accessories | SECURITY SYSTEMS — Car alarms • Bike alarms • Mechanical blockers • Immobilizers • Sensors • Accessories | OPTIC AND LIGHT — Xenon • Bixenon • Lamps
 • LED • Stroboscopes • Optic and Headlights • Washers • Light, rain sensors • Accessories | PARKTRONICS AND MIRRORS — Rear parktronic • Front parktronic • Combined parktronic • Rear-view mirrors
 • Accessories | HEATING AND COOLING — Seat heaters • Mirrors heaters • Screen-wipers heaters • Engine heaters • Auto-refrigerators • Air conditioning units • Accessories | TUNING — Vibro-isolation
 • Noise-isolation • Tint films • Accessories | ACCESSORIES — Radar-detectors • Handsfree, Bluetooth • Windowlifters • Compressors • Beeps, loudspeakers • Measuring instruments • Cleaners • Carsits
 • Miscellaneous | MOUNTING — Installation kits • Upholstery • Grilles • Tubes • Cable and wire • Tools • Miscellaneous | POWER — Batteries • Converters • Start-charging equipment • Capacitors
 • Accessories | MARINE AUDIO AND ELECTRONICS — Marine receivers • Marine audio speakers • Marine subwoofers • Marine amplifiers • Accessories | CAR CARE PRODUCTS — Additives • Washer fluid •
 Care accessories • Car polish • Flavors • Adhesives and sealants | LIQUID AND OIL — Motor oil • Transmission oil • Brake fluid • Antifreeze • Technical lubricant



In store "130" you can find and buy almost all necessary goods for your auto in Kyiv and other cities, delivery by ground and postal services. Our experienced consultants will provide you with exhaustive information and help you to chose the very particular thing. We are waiting for you at the address

<http://130.com.ua>

FOR CAR USE ONLY/NUR FÜR AUTOMOBIL GEBRAUCH/POUR APPLICATION AUTOMOBILE UNIQUEMENT/
PARA USO EN AUTOMÓVILES/SOLO PER L'UTILIZZO IN AUTOMOBILE/ENDAST FÖR BILBRUK

ALPINE®

DISC CHANGER

DHA-S690

MP3 AAC



- OWNER'S MANUAL
Please read before using this equipment.
- BEDIENUNGSANLEITUNG
Lesen Sie diese Bedienungsanleitung bitte vor
Gebrauch des Gerätes.
- MODE D'EMPLOI
Veuillez lire avant d'utiliser cet appareil.
- MANUAL DE OPERACIÓN
Léalo antes de utilizar este equipo.
- ISTRUZIONI PER L'USO
Si prega di leggere prima di utilizzare
l'attrezzatura.
- ANVÄNDARHANDLEDNING
Innan du använder utrustningen bör du läsa
igenom denna användarhandledning.

ALPINE ELECTRONICS MARKETING, INC.
1-1-8 Nishi Gotanda,
Shinagawa-ku,
Tokyo 141-0031, Japan
Phone 03-5496-8231

ALPINE ELECTRONICS OF AMERICA, INC.
19145 Gramercy Place, Torrance,
California 90501, U.S.A.
Phone 1-800-ALPINE-1 (1-800-257-4631)

ALPINE ELECTRONICS OF CANADA, INC.
777 Supertest Road, Toronto,
Ontario M3J 2M9, Canada
Phone 1-800-ALPINE-1 (1-800-257-4631)

ALPINE ELECTRONICS OF AUSTRALIA PTY. LTD.
161-165 Princes Highway, Hallam
Victoria 3803, Australia
Phone 03-8787-1200

ALPINE ELECTRONICS GmbH
Frankfurter Ring 117, 80807 München, Germany
Phone 089-32 42 640

ALPINE ELECTRONICS OF U.K. LTD.
Alpine House
Fletchamstead Highway, Coventry CV4 9TW, U.K.
Phone 0870-33 33 763

ALPINE ELECTRONICS FRANCE S.A.R.L.
(RCS PONTOISE B 338 101 280)
98, Rue de la Belle Etoile, Z.I. Paris Nord II,
B.P. 50016, 95945 Roissy Charles de Gaulle
Cedex, France
Phone 01-48638989

ALPINE ITALIA S.p.A.
Viale C. Colombo 8, 20090 Trezzano
Sul Naviglio (MI), Italy
Phone 02-484781

ALPINE ELECTRONICS DE ESPAÑA, S.A.
Portal de Gamarra 36, Pabellón, 32
01013 Vitoria (Alava)-APDO 133, Spain
Phone 945-283588

ALPINE ELECTRONICS (BENELUX) GmbH
Leuvensesteenweg 510-B6,
1930 Zaventem, Belgium
Phone 02-725-13 15

EN

DE

FR

ES

IT

SE

130.com.ua

Contents

Operating Instructions

WARNING

WARNING	3
CAUTION	3
PRECAUTIONS	4
Discs Playable on This Unit	5

Getting Started

When Using the Remote Control	7
Battery Replacement	7
Handling the Magazine	7
Turning Power On and Off	9
Selecting the Disc	9
Displaying a Disc List	9
Switching between NTSC and PAL	9
Initial System Start-Up	9

DVD/Video CD

Playing DVD/Video CD	10
Displaying a Programme List	10
Displaying a Playlist	11
Stopping Playback (PRE-STOP)	11
Stopping Playback	11
Fast-forwarding/Fast-reversing	11
Finding the Beginning of Chapters/Tracks or Files	11
Selecting Programme/Playlist	11
Selecting Title/Group	11
Displaying a Folder/File Menu List	12
Selecting Folders	12
Playing Still Frames (pausing)	12
Forward/reverse frame-by-frame Playback	12
Slow Motion Playback	12
30 Seconds Forwarding Jump Function	12
Scroll to Move the Page Forward or Back	12
Searching by Programme or Playlist Number	12

Searching by Title/Group/Folder Number	13
Searching Directly by Chapter/Track/File Number	13
Recalling a Title/Folder/Chapter, etc. Number using the LIST Button	13
Repeat Playback	13
Switching the Audio Tracks	14
Switching the Angle	14
Switching the Subtitles (subtitle language)	15
Displaying the Disc Status	15

CD/MP3/WMA/AAC

Playback	16
Selecting Folders (MP3/WMA/AAC)	16
M.I.X. (Random Play)	16
Repeat Play	16
Searching Directly by File Number (MP3/WMA/AAC)	17
Recalling a Track/Folder/File Number	17
Displaying a Folder/File List (MP3/WMA/AAC)	17
Displaying the Disc Status	17
About MP3/WMA/AAC	17

SETUP

SETUP Operation	19
-----------------------	----

DVD CONTENTS SETUP

Setting the language	19
Setting the Country Code	20
Setting the Rating Level (Parental Lock)	20
Change the Password	20
Setting the DVD Audio Playback Mode	20
Setting the DVD-VR Playback Mode	20
Playing the Bonus Group	20
Playing back a Main Story directly	21
Selecting the Button on the Image Screen automatically	21

SYSTEM SETUP

Switching the Background Colour	21
Setting the TV Screen	21
Setting the TV System.....	21
Setting the Disc Change	21
Delaying Image Output	21
Setting the Connected Head Unit	21
Returning to the Initial Setting	22

CD CONTENTS SETUP

Playing MP3/WMA/AAC/DivX® Data	22
Setting the Video CD Play Mode	22
Setting Compression Playback Data	22
Setting Playback simultaneously	22
Setting Time for Still Image Playback	22
Setting the Display	22
Displaying the DivX® registration code (DivX)	22

AUDIO SETUP

Setting the Digital Output	22
Setting the Downmix Mode	23

Other Useful Features

To Output DVD Video While Listening to Another Source (CD/radio, etc.) (only when using Ai-NET)	24
Setting the Wallpaper	24
Operating from the Head Unit	25
Playing DVDs, video CDs, CDs and MP3/WMA/AAC	25

Remote Control

Controls on Remote Control	26
----------------------------------	----

Information

About DVDs	27
About DivX®	28
About JPEG	28
About WAV	28
About ASF	28
Terminology	29
List of Language Codes	30
List of Country Codes	31
In Case of Difficulty	33
Specifications	35

Installation and Connections

Warning	36
Caution	36
Precautions	36
Preparation	37
Connecting	37
Mounting the Remote Control Sensor Unit	37
Installation	38
Checking Operation	39
Connections	40
Setting the System Switch	41
System Example	41

Operating Instructions

WARNING

WARNING

This symbol means important instructions. Failure to heed them can result in serious injury or death.

DO NOT OPERATE ANY FUNCTION THAT TAKES YOUR ATTENTION AWAY FROM SAFELY DRIVING YOUR VEHICLE.

Any function that requires your prolonged attention should only be performed after coming to a complete stop. Always stop the vehicle in a safe location before performing these functions. Failure to do so may result in an accident.

KEEP THE VOLUME AT A LEVEL WHERE YOU CAN STILL HEAR OUTSIDE NOISES WHILE DRIVING.

Excessive volume levels that obscure sounds such as emergency vehicle sirens or road warning signals (train crossings, etc.) can be dangerous and may result in an accident. LISTENING AT LOUD VOLUME LEVELS IN A CAR MAY ALSO CAUSE HEARING DAMAGE.

DO NOT DISASSEMBLE OR ALTER.

Doing so may result in an accident, fire or electric shock.

USE ONLY IN CARS WITH A 12 VOLT NEGATIVE GROUND.

(Check with your dealer if you are not sure.) Failure to do so may result in fire, etc.

KEEP SMALL OBJECTS SUCH AS BATTERIES OUT OF THE REACH OF CHILDREN.

Swallowing them may result in serious injury. If swallowed, consult a physician immediately.

USE THE CORRECT AMPERE RATING WHEN REPLACING FUSES.

Failure to do so may result in fire or electric shock.

USE THIS PRODUCT FOR MOBILE 12V APPLICATIONS.

Use for other than its designed application may result in fire, electric shock or other injury.

DO NOT PLACE HANDS, FINGERS OR FOREIGN OBJECTS IN INSERTION SLOTS OR GAPS.

Doing so may result in personal injury or damage to the product.



CAUTION

This symbol means important instructions. Failure to heed them can result in injury or material property damage.

HALT USE IMMEDIATELY IF A PROBLEM APPEARS.

Failure to do so may cause personal injury or damage to the product. Return it to your authorized Alpine dealer or the nearest Alpine Service Centre for repairing.

DO NOT MIX NEW BATTERIES WITH OLD BATTERIES. INSERT WITH THE CORRECT BATTERY POLARITY.

When inserting the batteries, be sure to observe proper polarity (+ and -) as instructed. Rupture or chemical leakage from the battery may cause fire or personal injury.

PRECAUTIONS

Product Cleaning

Use a soft dry cloth for periodic cleaning of the product. For more severe stains, please dampen the cloth with water only. Anything else has the chance of dissolving the paint or damaging the plastic.

Temperature

Do not operate your unit in ambient temperature above +60°C (+140°F) or below -10°C (+14°F).

Moisture Condensation

You may notice the disc playback sound wavering due to condensation. If this happens, remove the disc from the player and wait about an hour for the moisture to evaporate.

Damaged Disc

Do not attempt to play cracked, warped, or damaged discs. Playing a bad disc could severely damage the playback mechanism.

Maintenance

If you have problems, do not attempt to repair the unit yourself. Return it to your Alpine dealer or the nearest Alpine Service Station for servicing.

New Discs

When a newly purchased disc is inserted into the changer magazine, the disc may fail to play after initial loading. This is caused by small bumps around the centre hole and outside of the disc, which prevent stable loading into the correct position. To remove the bumps, rub the inside edge of the hole and outside edge of the disc with a ball-point pen or other such instrument, then insert the disc again.

- *The mechanism automatically prevents this type of disc from playing as a protective measure. This is not an indication of faulty operation.*

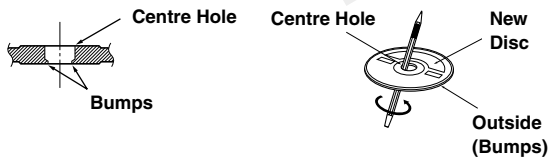

Irregular Shaped Discs

Be sure to use round shaped discs only for this unit and never use any special shaped discs. Use of special shaped discs may cause damage to the mechanism.

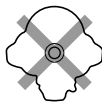

Installation Location

Make sure the DHA-S690 will not be installed in a location subjected to:

- Direct sun and heat
- High humidity and water
- Excessive dust
- Excessive vibrations

Correct Handling

Do not drop the disc while handling. Hold the disc so you will not leave fingerprints on the surface. Do not affix tape, paper, or gummed labels to the disc. Do not write on the disc.

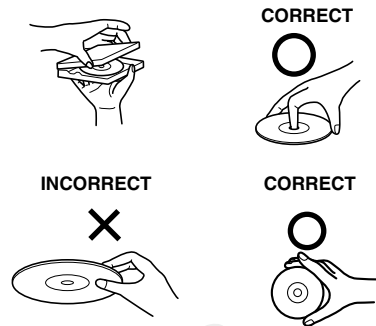

Disc Cleaning

Fingerprints, dust, or soil on the surface of the disc could cause the DVD changer to skip. For routine cleaning, wipe the playing surface with a clean, soft cloth from the centre of the disc to the outer edge. If the surface is heavily soiled, dampen a clean, soft cloth in a solution of mild neutral detergent before cleaning the disc.



Disc Accessories

There are various accessories available on the market for protecting the disc surface and improving sound quality. However, most of them will influence the thickness and/or diameter of the disc. Using such accessories can cause operational problems. We recommend not using these accessories on discs played in Alpine DVD changers.

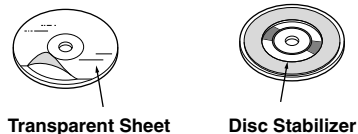

Discs Playable on This Unit

Playable discs

The discs listed below can be played on this unit.

	Mark (logo)	Recorded content	Disc size
DVD Video		Audio + Video	12 cm*
DVD Audio		Audio + Video	12 cm*
Video CD		Audio + Video	12 cm
Music CD		Audio	12 cm
DivX®		Audio + Video	12 cm

* Two-layer DVD disc compatible

The formatted discs listed below can be played on this unit.

	CD-R /CD-RW	DVD-R /DVD-RW	DVD+R /DVD+RW
CD Format	○		
MP3 Format ("mp3")	○	○	○
WMA Format ("wma")	○	○	○
AAC Format ("aac", "m4a")	○	○	○
WAV Format ("wav")	○	○	○
JPEG Format ("jpg", "jpeg", "jpe")	○	○	○
DVD Video Format		○	○
DVD-VR Format		○	
DivX Format ("avi", "divx")	○	○	○
ASF Format ("asf")	○	○	○
Video CD Format	○		

- Discs that are not finalised cannot be played back.
- ASF/WAV/JPEG are the same as MP3/WMA/AAC controllable from the unit.

Discs that cannot be played

DVD-ROMs, DVD-RAMs, CD-ROMs (excluding MP3/WMA/AAC/WAV/JPEG/ASF/DivX® files), photo CDs, etc.

DualDisc

This unit is not compatible with DualDisc.

Using a DualDisc may cause unit malfunction, and may cause disc damage when the disc is inserted/ejected.

DVD region number (playable region number)

This DVD changer will play back any disc whose region number is 2 (or All). DVDs with a region number other than those listed below, cannot be played on this DVD changer.



Video CDs

This DVD changer is compatible with playback control (PBC) compatible Video CDs (version 2.0).

"PBC" is a function by which you can use menu screens recorded on the disc to find the scene you want to watch and view various types of information in dialogue style.

Using compact discs (CD/CD-R/CD-RW)

If you use unspecified compact discs, correct performance cannot be guaranteed.

You can play CD-Rs (CD-Recordable)/CD-RWs (CD-ReWritable) which have been recorded only on audio devices. You can also play CD-Rs/CD-RWs containing MP3/WMA/AAC/WAV/JPEG/ASF/DivX® formatted audio files.

- Some of the following discs may not play on this unit: Flawed discs, discs with fingerprints, discs exposed to extreme temperatures or sunlight (e.g., left in the car or this unit), discs recorded under unstable conditions, discs on which a recording failed or a re-recording was attempted, copy-protected CDs which do not conform to the audio CD industry standard.
- Use discs with MP3/WMA/AAC/WAV/JPEG/ASF/DivX® files written in a format compliant with this unit. For details, MP3/WMA/AAC: see pages 17 and 18, DivX®/JPEG/WAV/ASF: see page 28.

To customers using CD-R/CD-RW

- If a CD-R/CD-RW cannot be played back, make sure the last recording session was closed (finalised).
- Finalise the CD-R/CD-RW if necessary, and attempt playback again.

Tips for making your own CDs

The DHA-S690 plays DVD Video, DVD Audio, Video CD, Audio CD, DivX® and has a built in MP3/WMA/AAC decoder.

The following information is designed to help you create your own music CDs (either Audio CD or MP3/WMA/AAC encoded CD-R/RW files).

What is the difference between an Audio and MP3/WMA/AAC CD?

An Audio CD is the same format as the commercial CDs you buy in the store (also known as CD-DA). MP3 (MPEG-1 Audio Layer 3)/WMA (Windows Media Audio)/AAC (Advanced Audio Coding) is a data file that uses a compression scheme to reduce the size of the music file.*

Hybrid Audio CD and Data (MP3/WMA/AAC) CD-R/RW discs:

The DHA-S690 can read either sector on the disc. Choose CD-DA to play the CD audio section or MP3/WMA/AAC to play the MP3/WMA/AAC section.*

Multi session CD-R/RW:

Once a recording has been stopped, this is considered one session. If the disc is not closed (finalised), additional data may be added. Once this additional data has been recorded, this becomes a "multi-session" CD. The DHA-S690 can only read multi-session DATA Formatted discs (MP3/WMA/AAC files - Not Audio CD files).

Properly formatted MP3/WMA/AAC Discs:

Use ISO9660 formatting to insure proper playback. You may use standard ISO naming Level 1 (8.3 DOS standard), Level 2 (32 characters) or Joliet (Windows or Macintosh long filenames) file naming conventions*.

* Please consult the Owner's manual for additional information.

On handling compact discs (CD/CD-R/CD-RW)

- Do not touch the surface.
- Do not expose the disc to direct sunlight.
- Do not affix stickers or labels.
- Clean the disc when it is dusty.
- Make sure that the disc is smooth and flat.
- Do not use commercially available disc accessories.

Do not leave the disc in the car or the unit for a long time. Never expose the disc to direct sunlight.

Heat and humidity may damage the disc and you may not be able to play it again.

Using DVD-Rs/DVD-RWs/DVD+Rs/DVD+RWs

- This unit is compatible discs recorded in the DVD-Video and DVD-VR (DVD-R/DVD-RW only) mode.
- Note that discs not finalised (processed to enable to play on playback-only DVD players) cannot be played on this DVD changer.
- Some discs may not play back, depending on the recording device and disc format.
- Discs or files utilizing copy protection, may not be playable. Some recording systems may not properly format copied files to enable proper playback.
- In the following cases, the disc may not play on this unit: discs recorded by certain DVD recorders, certain irregular discs, flawed discs, dirty discs, when the pickup lens of this DVD changer is dirty, or when moisture condensation has occurred inside the unit.
- Be sure to follow all cautions included with your DVD-Rs/DVD-RWs/DVD+Rs/DVD+RWs discs.
- Do not put stickers, seals, or tape on the label side of DVD-Rs/DVD-RWs/DVD+Rs/DVD+RWs.
- Compared to the regular discs, DVD-Rs/DVD-RWs/DVD+Rs/DVD+RWs are more affected by heat, moisture, and direct sunlight. If left in a car, etc., damage may occur and it might not play on this unit.
- The operable temperature range for disc playback is as follows:
DVD-R/DVD-RW: -25 ~ +70°C
DVD+R/DVD+RW: +5 ~ +55°C

Disc terminology

Title

If titles are programmed for the DVD, these are the largest units of division of the information recorded on the disc.

Chapter

Each Title may also be divided into smaller divisions, called chapters. These can be specific scenes or musical selections.

- *This product incorporates copyright protection technology that is protected by U.S. patents and other intellectual property rights. Use of this copyright protection technology must be authorized by Macrovision, and is intended for home and other limited viewing uses only unless otherwise authorized by Macrovision. Reverse engineering or disassembly is prohibited.*
- *Manufactured under license from Dolby Laboratories. "Dolby", "Pro Logic" and the double-D symbol are trademarks of Dolby Laboratories.*
- *"DTS" is a registered trademark of DTS, Inc. and "DTS 2.0 + Digital Out" is a trademark of DTS, Inc.*
- *Windows Media and the Windows logo are trademarks, or registered trademarks of Microsoft Corporation in the United States and/or other countries.*
- *"MPEG Layer-3 audio coding technology licensed from Fraunhofer IIS and Thomson"*
- *"Supply of this product only conveys a license for private, non-commercial use and does not convey a license nor imply any right to use this product in any commercial (i.e. revenue-generation) real time broadcasting (terrestrial, satellite, cable and/or any other media), broadcasting/streaming via internet, intranets and/or other networks or in other electronic content distribution systems, such as pay-audio or audio-on-demand applications. An independent license for such use is required. For details, please visit <http://www.mp3licensing.com>"*

Getting Started

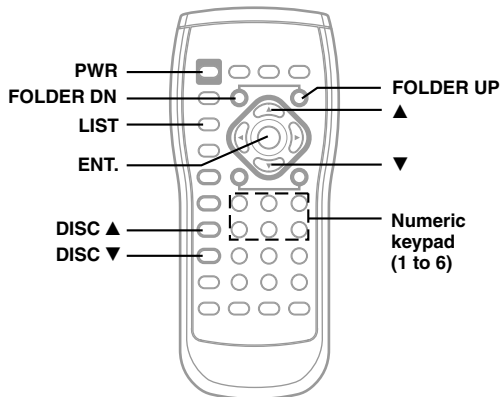

When Using the Remote Control

- Point the remote control at the remote sensor within about 2 meters.
- It may not be possible to operate the remote control if the remote control sensor is exposed to direct sunlight.
- The remote control is a small, lightweight precision device. To avoid damage, short battery life, operational errors and poor response, observe the following.
 - Do not subject the remote control to excessive shock.
 - Do not put in a trouser pocket.
 - Keep away from food, moisture and dirt.
 - Do not place in direct sunshine.

Battery Replacement

Battery type: CR2025 battery or equivalent.

1 Opening the battery case.

Slide out the battery cover while firmly pressing in the direction of the arrow.

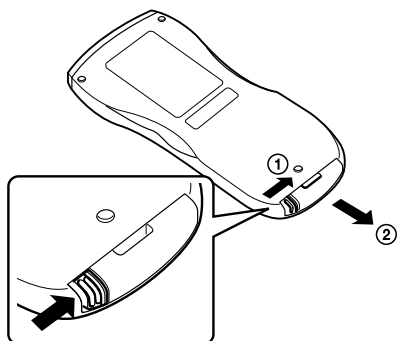

2 Replacing the battery.

Put the battery in the case with the (+) indication upward as shown in the illustration.

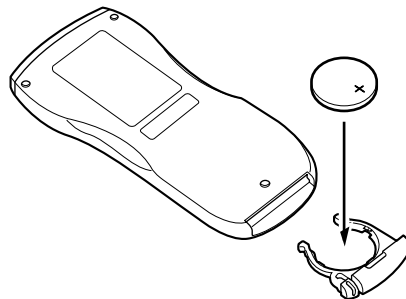

- Placing a battery in backwards way may cause a malfunction.

3 Closing the cover.

Slide the cover as illustrated until a click is heard.

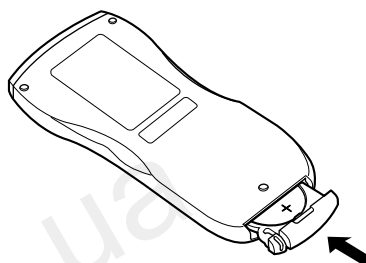

Warning

DO NOT OPERATE ANY FUNCTION THAT TAKES YOUR ATTENTION AWAY FROM SAFELY DRIVING YOUR VEHICLE.

Any function that requires your prolonged attention should only be performed after coming to a complete stop. Always stop the vehicle in a safe location before performing these functions. Failure to do so may result in an accident.

Handling the Magazine

Turn on the power before loading and unloading discs. (Refer to "Turning Power On and Off" on page 9.)

Loading discs

- 1 Pull the tray removal knob with your finger and draw the disc tray out of the magazine. Be careful not to drop the disc.

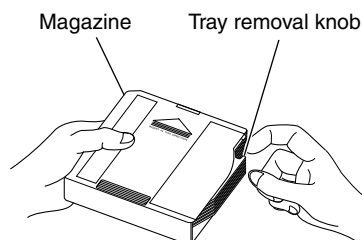

- Do not remove the disc tray from the magazine. When the disc tray is pulled out from the magazine, do not pull it out with excessive force. Doing so will cause breakdown.

- 2** Set discs in the disc tray with the labeled side facing up. Set one disc in the tray at a time (up to 6 discs).
Be careful not to drop the disc.
After loading the discs, push the disc tray fully into the magazine until it closes and a click is heard.

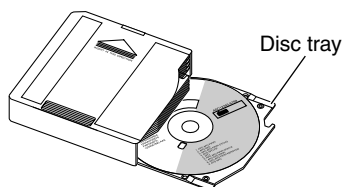

- 3** Grasp the sliding door knob and slide the door fully to the right.

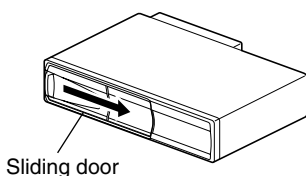

- 4** Make sure the magazine is in the proper direction (top/bottom and front/back), then push it in fully until a click is heard and the magazine is locked in place.

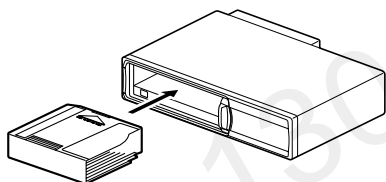

- 5** After inserting the magazine, grasp the tab of the sliding door and slide the door all the way to the left until it locks with a "click".

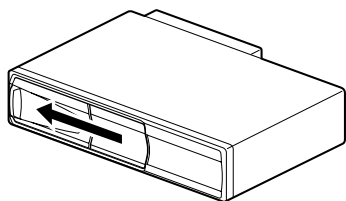

- When the magazine is inserted, a check of the disc inside the magazine is performed automatically.

Removing discs

- 1** Grasp the sliding door knob and slide the door fully to the right.

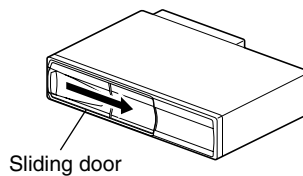

- 2** Press the eject button to eject the magazine, then remove the magazine.

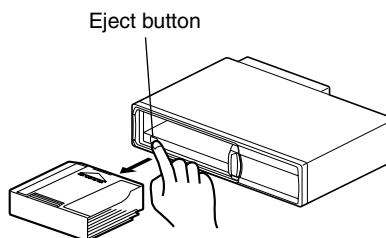

- 3** Pull the tray removal knob with your finger and draw the disc tray out of the magazine. Pay attention to the disc's signal surface when removing discs. (See "PRECAUTIONS" on page 4.)

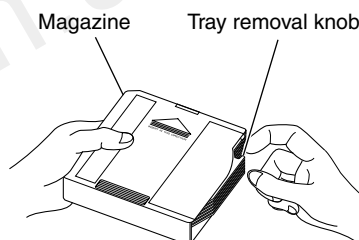

- Do not remove the disc tray from the magazine.
When the disc tray is pulled out from the magazine, do not pull it out with excessive force. Doing so will cause breakdown.

Cautions on using the magazine

- This product's magazine is used exclusively for this product. CD changer magazines (included magazines or accessories) cannot be used with this product.
- Disc trays for CD changer magazines cannot be used with this product's magazine. Such trays can be inserted for reasons of structure, but using them may damage this product. Never use disc trays for CD changer magazines.
- Do not forcibly remove the magazine.
- Only one disc can be inserted per tray. Attempting to insert two or more discs will result in damage.
- Never remove the tray from the magazine.
- Even when the ignition key is set to OFF, the magazine can be removed.

Turning Power On and Off

Play Position Memory Function

If you turn power off or switch the ignition key to OFF during playback or change the source, playback will continue from the point where playback stopped when the power is turned ON again. The play position memory is cancelled when the magazine is removed or a disc is changed.

When connecting to the head unit using Ai-NET

Caution

- To customers using the ALPINE head unit. Before using this unit connected to an Ai-NET compatible AV head unit or Ai-NET compatible head unit, make the appropriate settings in "Setting the System Switch" (page 41).
- With this unit connected to an Ai-NET compatible AV head unit or Ai-NET compatible head unit, there may be some delay during power-up from the remote control. This is caused by the systems communications being carried out by the various components and is not a defect.
- When connected with an Ai-NET compatible AV head unit or Ai-NET compatible head unit, the power cannot be turned off from the remote control. Turn off the DHA-S690 power by switching the head unit's source. For details, refer to "Operating from the Head Unit" (page 25).

1 Set the head unit's source to DVD changer or CD changer.

The power turns on.

2 To turn the power off, change the head unit's source.

When connecting to the head unit without using Ai-NET

Caution

To customers connecting the head unit without Ai-NET. When using this unit without an Ai-NET connection, read "Setting the System Switch" on page 41 and set "system switching" to "2" (STANDALONE).

1 Press PWR of the remote control.

The power turns on.

2 To turn the power off, press PWR again.

Selecting the Disc

Press and hold any one of the buttons (1 through 6) for at least 2 seconds.

The 1 through 6 buttons correspond to the disc number 1 to 6.

- You can change a disc by pressing DISC ▼, ▲ or pressing and holding FOLDER DN/UP for at least 2 seconds.

Displaying a Disc List

Disc information loaded on the unit is displayed as a list, and disc change can be directly performed.

1 Press and hold LIST for at least 2 seconds.

The disc list is displayed.

Disc list display example

■ DISC LIST		
DISC	MEDIA	CONTENTS
1	DVD	DVD-V
2	CD	CDDA
3	NO DISC	
4	CD	COMPRESS
5	DVD	--
6	DVD	DVD-A

①

②

③

- Displays disc No.
- Displays disc media.
 - "NO DISC" is displayed if no disc is loaded on the tray.
- Displays content information.
 - DVD-V : DVD Video
 - DVD-A : DVD Audio
 - VCD : Video CD
 - DVD-VR : DVD-VR
 - CDDA : CD-DA
 - COMPRESS : Compressed Audio (MP3/WMA/AAC/ASF/WAV/JPEG/DivX®)
 - : If a disc cannot be read.

2 Press ▲ or ▼ to select the desired disc, and then press ENT.

The unit changes to the selected disc and starts playback.

Switching between NTSC and PAL

Set the output configuration to NTSC or PAL, depending on the disc.

Press and hold PWR for at least 2 seconds.

- PAL is the standard. The system is set to PAL at time of shipment from the factory.
- To play back an NTSC compatible disc, change the setting by referring to "Setting the TV System" (page 21).

Initial System Start-Up

Be sure to press the RESET button when using the unit for the first time, after changing the car battery, etc.

1 Turn off the unit power.

2 Press RESET with a ball-point pen or similar pointed object.

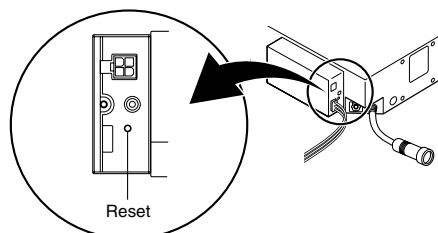

DVD/Video CD

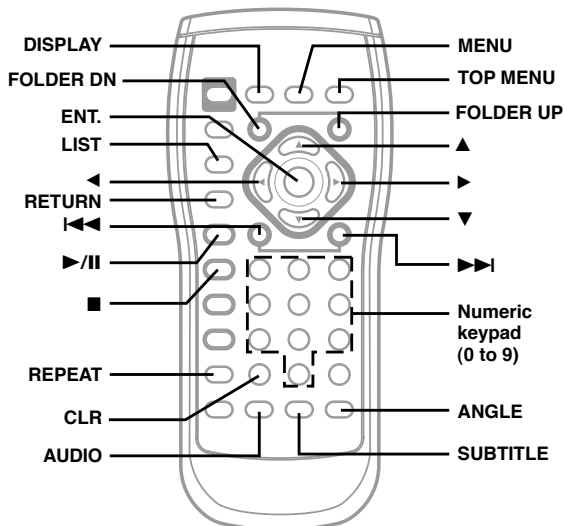

Playing DVD/Video CD

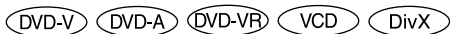

Disc types that can be used for each heading are represented by the following marks.

- DVD-V** DVD Commercial Video discs (used for the distribution of movies, etc.) or a DVD-R/DVD-RW, DVD+R/DVD+RW recorded in a video mode can be used. (including discs containing both DVD video and DVD audio data that are played back when "DVD-V" is set in "Setting the DVD Audio Playback Mode" (page 20)).
- DVD-A** DVD Commercial Audio discs can be used.
- DVD-VR** DVD-R/DVD-RW discs recorded in DVD-VR mode can be used.
- VCD** Video-CD discs can be used.
- DivX** CD-R/CD-RW/DVD-R/DVD-RW/DVD+R/DVD+RW discs that are recorded in the DivX® mode can be used.

Caution

- Not all functions will operate for every DVD. See the individual DVD's instructions for details on the features supported.
- Fingerprints on a disc may adversely affect playback. If a problem occurs, remove the disc and check for fingerprints on the playback side. Clean the disc if necessary.
- When using the remote control, be careful to press one button at a time. Pressing multiple buttons at the same time may cause erroneous operation.
- If you switch the power or ignition key OFF, or change sources during playback, playback will continue where you left off when you resume playback.
- If you try to perform an invalid operation (based on the type of disc being played), the following mark is displayed on the monitor screen: (When the red indicator is displayed, disc operation is prohibited. When the white indicator is displayed, unit playback is prohibited.)

Insert a disc with the label side facing up.

To load discs, see "Handling the Magazine" on page 7. Playback starts.

- The reverse side of a double-sided DVD will not be played automatically. Remove the disc, turn it over, and reinsert it.
- It may take some time before playback starts after loading a disc.
- To return to the previous screen during Video CD playback, press **RETURN**. However, the function may vary depending on the disc.
- While "INDEX READ" is displayed by DivX®, the fast-forwarding/fast-reversing and repeat functions, etc., cannot be used.
- While playing back a video CD with Playback Control (PBC), if the **SELECT** screen is displayed, you can play back by pressing and holding **>/II** for at least 2 seconds.

If a menu screen appears

On DVDs and video CDs with playback control (PBC), menu screens may appear automatically. If this happens, perform the operation described below to start playback.

- For many discs, the menu screen can also be displayed by pressing **MENU**.

DVD menu

Press **▲**, **▼**, **◀** or **▶** to select the desired item, then press **ENT**.

- For some discs it is possible to select items directly from the menu screen using the **numeric keypad** ("0" to "9").
- If the DVD-Audio disc is set to "VIDEO ON", operation can be performed. (Refer to "Setting the DVD Audio Playback Mode" on page 20.)

Video CD menu

Use the **numeric keypad** ("0" to "9") to select the desired number, then press **ENT**.

- Depending on the number of digits input, playback may start automatically even if **ENT** is not pressed.
- The menu screen does not appear when the **PBC** function is turned off. In this case, set **VCD PLAY MODE** to turn on the **PBC** function. For details, refer to "Setting the Video CD Play Mode" (page 22).

Displaying a Programme List

1 Press **TOP MENU** while playing a DVD-VR disc. The programme list screen is displayed.

2 Press **▲** or **▼** to select the desired programme, then press **ENT**. The selected programme is played back.

- If **PLAYLIST** is selected, the playlist list screen is displayed.
- If a disc name or programme name exceeds the display range, the last character that appears in the display range is displayed as "~" (tilde accent).

Displaying a Playlist (DVD-VR)

- 1 Press **MENU** while playing DVD-VR disc.
The playlist list screen is displayed.
- 2 Press **▲** or **▼** to select the desired playlist, then press **ENT**.
The selected playlist is played back.
 - Only discs containing a playlist can be operated.
 - If **PROGRAM LIST** is selected, the programme list screen is displayed.
 - If a disc name or playlist name exceeds the display range, the last character that appears in the display range is displayed as “~” (tilde accent).

Stopping Playback (PRE-STOP)

(DVD-V) (DVD-A) (DVD-VR) (VCD) (DivX)

Press **■** during playback to stop playback. That position is stored in memory.

- 1 During playback, press **■**.
“PRE-STOP” is displayed.
- 2 Press **►/II** in the **PRE-STOP** mode.
Playback starts from the position at which it was stopped.
 - For some discs, the position at which playback was stopped may not be accurate.
 - When “**VIDEO OFF**” is set, **PRE-STOP** function is not available for the DVD Audio disc. (Refer to “Setting the DVD Audio Playback Mode” on page 20.)

Stopping Playback

(DVD-V) (DVD-A) (DVD-VR) (VCD) (DivX)

During playback, press **■** twice.

“STOP” is displayed, and playback stops.

- Playback stops also when **■** is pressed for more than 2 seconds.
- Playback starts from the beginning when **►/II** is pressed while playback is stopped.
- When **VIDEO OFF** is set, press **■** once to stop DVD audio playback (STOP). Refer to “Setting the DVD Audio Playback Mode” (page 20).

Fast-forwarding/Fast-reversing

(DVD-V) (DVD-A) (DVD-VR) (VCD) (DivX)

DVD Video / DVD Audio / Video CD / DivX®

- 1 During playback, press and hold **◀◀** (fast-reverse) or **▶▶** (fast-forward) .
When pressed for more than 1 second, the disc is forwarded/reversed at double speed.
When held for 5 more seconds, the disc is forwarded/reversed at 8 times the normal speed.
When held for 10 more seconds, the disc is forwarded/reversed at 32 times the normal speed.
- 2 Release **◀◀** or **▶▶** to return to normal playback.
 - No sound is played during fast-forwarding/fast-reversing.
 - Fast-forwarding/fast-reversing of only a track being played back can be made on the Video CD equipped with **PBC** (playback control).
 - For DVDs and video CDs with playback control (**PBC**), the menu screen may reappear during fast-forwarding/fast-reversing.

Finding the Beginning of Chapters/Tracks or Files (DVD-V) (DVD-A) (DVD-VR) (VCD) (DivX)

During playback, press **◀◀** or **▶▶**.

The chapter/track/file switches each time the button is pressed, and playback of the selected chapter/track/file starts.

- ▶▶**: Press this to start playback from the beginning of the following chapter, track or file.
- ◀◀**: Press this to start playback from the beginning of the current chapter, track or file.

- Some DVDs do not have chapters.
- The beginning of a track may not be found on the Video CD equipped with **PBC** (playback control). Set **VCD PLAY MODE** to turn the **PBC** function off. Refer to “Setting the Video CD Play Mode” (page 22).
- During pause, operation can be performed for DVD Audio, DivX®.

Supplementary explanations

“**Chapters**” are divisions of movies or musical selections on DVDs.

“**Tracks**” are divisions of movies or musical selections on video and music CDs.

“**Groups**” associate a track (one song) with other tracks stored on a DVD-Audio.

Group playback differs, depending on the disc.

“**Playlists**” specify a range of images and their playback order.

- Only discs containing a playlist can be used.

Selecting Programme/Playlist (DVD-VR)

During playback or pause, press **FOLDER UP, DN** to select the previous or next programme/playlist.

The programme/playlist switches each time the button is pressed, and playback of the selected programme/playlist starts.

- UP**: Press this to start playback from the beginning of the following programme or playlist.
- DN**: Press this to start playback from the beginning of the previous programme or playlist.

- Only when a playlist is managed on the disc, playlist can be selected and operation can be performed.

Selecting Title/Group (DVD-V) (DVD-A)

During playback or pause, press **FOLDER UP, DN** to select the previous or next title/group.

The title/group switches each time the button is pressed, and playback of the selected title/group starts.

- UP**: Press this to start playback from the beginning of the following title or group.
- DN**: Press this to start playback from the beginning of the previous title or group.

Displaying a Folder/File Menu List (DivX)

If a file from the folder menu list is selected:

- 1 During playback, press TOP MENU.**
The folder list in a disc is displayed.
- 2 Press ▲ or ▼ to select the desired folder and press ENT.**
The file menu list in the selected folder is displayed.
- 3 Press ▲ or ▼ to select the desired file and press ENT.**
Playback of the selected file starts.

If a file from the file menu list is selected:

- 1 During playback, press MENU.**
The file menu list in the disc folder is displayed.
 - 2 Press ▲ or ▼ to select the desired file and press ENT.**
Playback of the selected file starts.
- If a folder name or file name exceeds the display range, the last character that appears in the display range is displayed as “~” (tilde accent).
 - MP3/WMA/AAC folder/file list is also displayed.

Selecting Folders (DivX)

Press **FOLDER DN** or **UP** to select the folder.

Playing Still Frames (pausing)

(DVD-V) (DVD-A) (DVD-VR) (VCD) (DivX)

- 1 During playback, press ►/II.**
 - 2 Press ►/II to resume playback.**
- No sound is output during the still mode.
 - The image or sound may stop temporarily when playback starts from the pause mode. This is not a malfunction.

Forward/reverse frame-by-frame Playback

(DVD-V) (DVD-VR) (VCD)

- 1 In the pause mode, press I◀◀ or ▶▶I.**
The picture advances or reverses by one frame each time the button is pressed.
 - 2 Press ►/II to resume normal playback.**
- No sound is output during forward/reverse frame-by-frame playback.
 - For DVD-VR and video CD, reverse frame-by-frame playback is not available.

Slow Motion Playback (DVD-V) (DVD-VR) (VCD)

- 1 When I◀◀ or ▶▶I is pressed and held in while in the pause mode, the 1/8th speed slow motion playback mode is set.**
When held for 5 more seconds, the slow motion speed switches to 1/2 the normal speed.
 - 2 Release I◀◀ or ▶▶I to pause, and press ►/II to playback.**
- No sound is output during slow motion playback.
 - Slow playback is not available when playing back a slide show.
 - 1/2 and 1/8 are approximate speeds. The actual speed differs from disc to disc.
 - For DVD-VR and video CD, reverse slow motion playback is not available.

30 Seconds Forwarding Jump Function

(DVD-VR) (DivX)

For example, if you want to jump CM while playing back an original programme of DVD-VR, pressing ►▶I will jump 30 seconds forward and play back.

If only one file is contained in the folder, the 30 seconds forward jump function can be used.

Pressing I◀◀ during playback will play back after jumping 30 seconds backwards. Pressing ►▶I will play back after jumping 30 seconds forward.

- This function is available for MP3, WMA, AAC, WAV or ASF.

Scroll to Move the Page Forward or Back

(DVD-A)

“Page” is still image stored on a DVD-Audio disc.

- During playback, press and hold 7 for at least 2 seconds to display the next still image. Pressing and holding 8 for at least 2 seconds will display the previous still image. Pressing and holding 9 for at least 2 seconds will display the home page.**
- For DVD-Audio discs without Pages, depending on the DVD-Audio disc, the “Page” function may not be operable if images are in slide show form.
 - If the DVD-Audio disc is set to “VIDEO ON”, operation can be performed. (Refer to “Setting the DVD Audio Playback Mode” on page 20.)

Searching by Programme or Playlist

Number (DVD-VR)

Use this function to easily find positions on the DVD using the DVD's programmes/playlists.

- 1 When playback stops, input the number of the programme or playlist you want to play back by using the numeric keypad (“0” to “9”).**
 - 2 Press ENT.**
Playback starts from the selected programme or playlist number.
- While in PRE-STOP, this function finds the beginning of the chapter by its number.
 - Press CLR to delete the last digit in the programme/playlist number. Press and hold CLR for at least 2 seconds to clear the programme or playlist number.
 - Depending on the number of digits input, playback may start automatically even if ENT. is not pressed in step 2.

Searching by Title/Group/Folder Number

DVD-V DVD-A DivX

Use this function to easily find positions on the DVD using the DVD's title/group/folder.

- 1 When playback stops, input the number of the title/group/folder you want to play back by using the numeric keypad ("0" to "9").**
- 2 Press ENT.**
Playback starts from the selected title/group/folder number.
 - Press **CLR** to delete the last digit in the title/group/folder number. Press and hold **CLR** for at least 2 seconds to clear all title/group/folder numbers.
 - Press **RETURN** to cancel the title/group/folder search mode.
 - Depending on the number of digits input, playback may start automatically even if **ENT.** is not pressed in step 2.
 - Playback starts from the beginning of the chapter/track number in the state of **PRE-STOP**.

Searching Directly by Chapter/Track/File Number

DVD-V DVD-A DVD-VR VCD DivX

Use this function to easily move to the beginning of the chapters, tracks or files on the disc.

- 1 Input the chapter, track or file number you want to play back by using the numeric keypad ("0" to "9") except when the unit stops playback.**
- 2 Press ENT.**
Playback starts from the selected chapter, track or file.
 - This function cannot be used on discs on which no chapter numbers are recorded.
 - Depending on the number of digits input, playback may start automatically even if **ENT.** is not pressed in step 2.
 - Press **CLR** to delete the last digit in the chapter/track/file number. Press and hold **CLR** for at least 2 seconds to clear "Chapter", "Track" or "File" numbers.
 - During stop, search can be made for Video CD.
 - The beginning of a track number cannot be directly found on the Video CD equipped with **PBC** (playback control). Set **VCD PLAY MODE** to turn the **PBC** function off. Refer to "Setting the Video CD Play Mode" (page 22).

Recalling a Title/Folder/Chapter, etc. Number using the LIST Button

DVD-V DVD-A DVD-VR VCD DivX

- 1 Press LIST during playback.**
The numeric keypad input mode to be searched is activated.
- 2 Input the title/group/folder/chapter/track/file/programme/playlist number you want to play back by using the numeric keypad ("0" to "9").**
- 3 Press ENT.**
Playback starts from the selected title/group/folder/chapter/track/file/programme/playlist number.
 - Depending on the input digit number, step 3 may not be necessary.

Repeat Playback

DVD-V DVD-A DVD-VR VCD DivX

Use this function to play the disc's titles, chapters, tracks, etc. repeatedly.

During playback, press REPEAT.

The repeat mode switches each time the button is pressed.

DVD Video

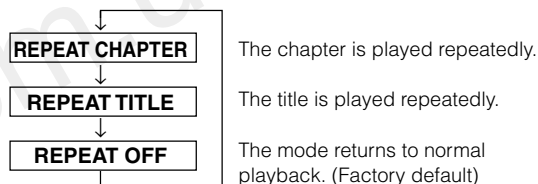

The chapter is played repeatedly.

The title is played repeatedly.

The mode returns to normal playback. (Factory default)

DVD Audio

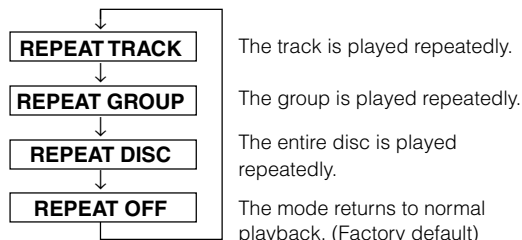

The track is played repeatedly.

The group is played repeatedly.

The entire disc is played repeatedly.

The mode returns to normal playback. (Factory default)

DVD-VR (while playing back programme)

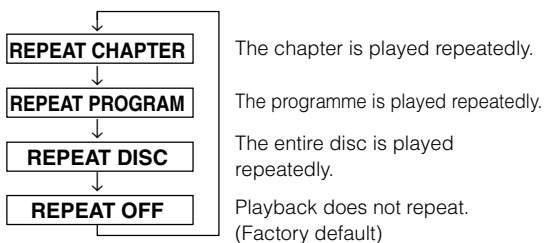

DVD-VR (while playing back Playlist)

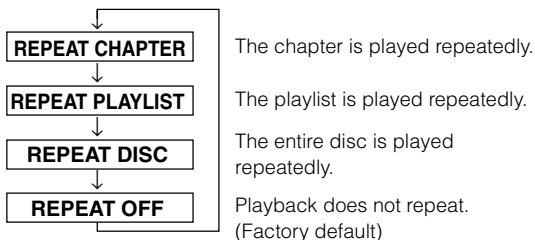

VIDEO CD

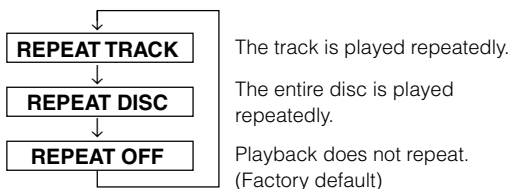

DivX®

Display example when "ALL" is set in "Setting Compression Playback Data" (page 22).

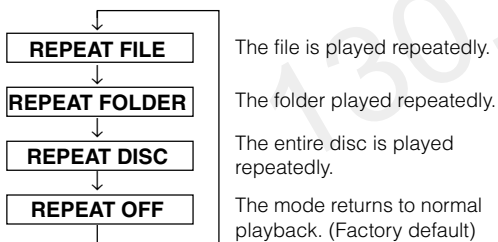

- The track/disc repeat modes cannot be used on video CDs with playback control (PBC). Set VCD PLAY MODE to turn the PBC function off. Refer to "Setting the Video CD Play Mode" (page 22).
- Depending on the DVD-VR disc, the repeat mode may not be changed.
- During playback, pressing and holding **REPEAT** for at least 2 seconds will change the unit to **REPEAT OFF**.

Switching the Audio Tracks

DVD-V DVD-A DVD-VR VCD DivX

For discs with multiple audio or audio languages, you can switch the audio language temporarily during playback.

During playback, press **AUDIO**.

The sound switches between the alternate audio tracks recorded on the disc each time the button is pressed.

- The selected audio track becomes the default setting every time the power is turned on or the disc is replaced. Depending on the disc, the unit plays back the disc's specified language.
- Not all discs will allow changing the alternate audio tracks during playback. In these cases, select audio tracks from the DVD's menu.
- There may be a delay before the selected alternate track begins to play.

DVD-VR/Video CDs with multiplex audio

DVD-VR

During playback, press and hold **AUDIO** for at least 2 seconds.

The left and right channels will be output as shown below, each time the button is pressed.

LR → LL → RR → LR

Video CD

During playback, press **AUDIO**.

The left and right channels will be output as shown below, each time the button is pressed.

LR → LL → RR → LR

Switching the Angle

DVD-V DVD-A

On DVDs in which scenes have been filmed from multiple angles, the angle can be switched during playback.

During playback, press **ANGLE**.

The angle switches between the angles recorded on the disc each time the button is pressed.

- Some time may be required for the angle to change.
- Depending on the disc, the angle may switch in one of two ways.
 - Seamless: The angle switches smoothly.
 - Non-seamless: When the angle is switched, a still picture is displayed first, after which the angle switches.
- If the DVD-Audio disc is set to "VIDEO ON", operation can be performed. (Refer to "Setting the DVD Audio Playback Mode" on page 20.)

Switching the Subtitles (subtitle language)

(DVD-V) (DVD-A) (DVD-VR) (DivX)

With multiple subtitle language DVDs, the subtitle language can be switched during playback, or subtitles can be hidden.

During playback, press **SUBTITLE**.

The subtitle switches between the languages recorded on the disc and OFF each time the button is pressed.

During DVD-VR playback, the display of the subtitle is set to ON or OFF.

- There may be a delay before the selected subtitle appears.
- Not all discs will allow changing the subtitles during playback. In these cases, select subtitles from the DVD's menu.
- The selected subtitle language becomes the default setting every time the power is turned on or the disc is replaced. Depending on the disc, the unit plays back the disc's specified language.
- For some discs, the subtitles will be displayed even when this is set to off.
- If the DVD-Audio disc is set to "VIDEO ON", operation can be performed. (Refer to "Setting the DVD Audio Playback Mode" on page 20.)

Tips

Switching from the disc menu.

For some discs, the audio language, angle and subtitles can be switched from the disc menu.

DVD Video

1. Press MENU, select the item, then press ENT.
2. Press ▲, ▼, ◀ or ▶ to select the language or angle, then press ENT.
(For some discs, they can be selected using the numeric keypad ("0" to "9") while the language or the angle menu is displayed.)

DVD Audio

1. Press TOP MENU, select the item, then press ENT.
2. Press ▲, ▼, ◀ or ▶ to select the language or angle, then press ENT.
(For some discs, they can be selected using the numeric keypad ("0" to "9") while the language or the angle menu is displayed.)

- If the DVD-Audio disc is set to "VIDEO ON", operation can be performed. (Refer to "Setting the DVD Audio Playback Mode" on page 20.)

Displaying the Disc Status

(DVD-V) (DVD-A) (DVD-VR) (VCD) (DivX)

Use the procedure described below to display the status (title number, chapter number, etc.) of the currently playing DVD on the monitor screen.

During playback, press **DISPLAY**.

The playback status is displayed.

The playback status display closes when DISPLAY is pressed again.

DVD Video display example

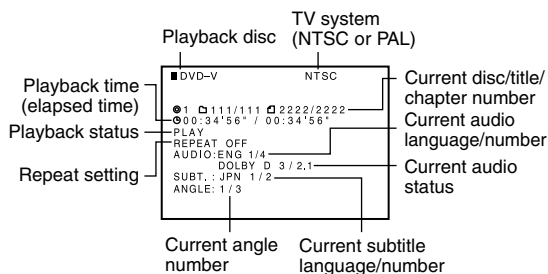

DVD Audio display example

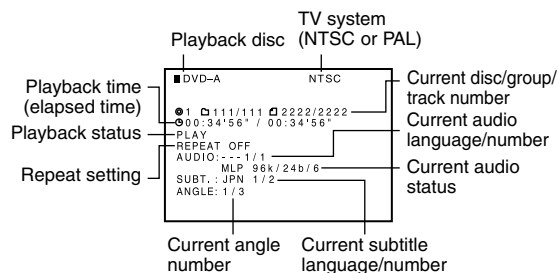

- If the DVD-Audio disc is set to "VIDEO ON", operation can be performed. (Refer to "Setting the DVD Audio Playback Mode" on page 20.)

DVD-VR display example

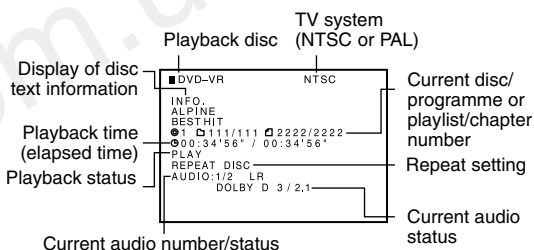

Video CD display example

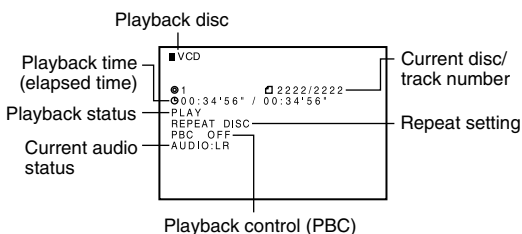

- When PBC is set to ON, the current track number and track playback time is not displayed.

DivX® display example

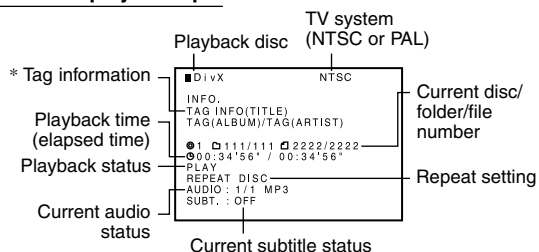

- If a DivX® file contains tag information, the file name/album name/artist name is displayed.

CD/MP3/WMA/AAC

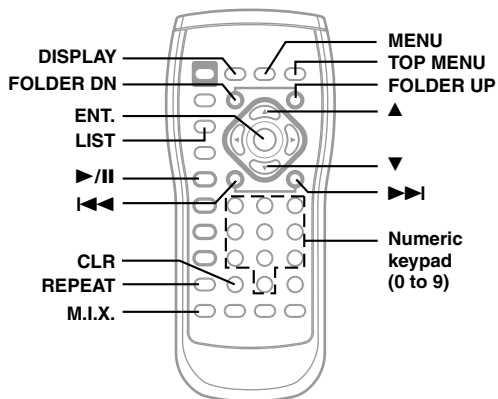

Playback

The DHA-S690 will play back MP3/WMA/AAC files stored on CD-ROMs, CD-Rs, and CD-RWs. The format used must be compliant with ISO9660 level 1 or level 2.

For further information about playing or storing MP3/WMA/AAC files, refer to pages 17 and 18 before using the unit.

1 Change the source on the head unit to the DVD changer or CD changer.

Playback starts.

2 Press << or >> to select the desired track (file).

Returning to the beginning of the current track:

Press <<.

Advancing to the beginning of the next track:

Press >>.

Fast forward/Fast backward :

When pressed for more than 1 second, the disc is forwarded/reversed at double speed.

When held for 5 more seconds, the disc is forwarded/reversed at 8 times the normal speed.

When held for 10 more seconds, the disc is forwarded/reversed at 32 times the normal speed.

3 To pause playback, press >/II.

Pressing >/II again will resume playback.

- MP3/WMA/AAC playback information (folder no., file no., tag information, etc.) will be displayed on the monitor during playback.
- For MP3 discs, some time may be required until playback starts.
- Some discs will not play back depending on the writing or MP3 conversion software used for the disc. In that case, try other software.
- WMA format files that are protected by DRM (Digital Rights Management), AAC format files that have been purchased from iTunes Music Store and files that are copy-protected (copyright protection) cannot be played back on this unit.
- The unit can play discs containing both audio data and MP3/WMA/AAC data.
- The playback time may not be correctly displayed when a VBR (Variable Bit Rate) recorded file is played back.
- ASF/WAV/JPEG are the same as MP3/WMA/AAC controllable from the unit.

Selecting Folders (MP3/WMA/AAC)

Press **FOLDER DN** or **FOLDER UP** to select the folder.

M.I.X. (Random Play)

Press **M.I.X.** in the play or pause mode.

The M.I.X. mode switches each time the button is pressed.

CD

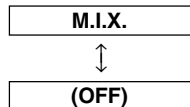

All tracks on a disc will be played back in a random sequence, and the changer will shift to the next disc.

(Factory default)

MP3/WMA/AAC/DivX®

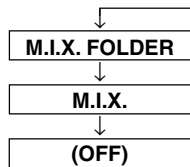

Only files in a folder are played back in a random sequence.

All tracks on a disc will be played back in a random sequence, and the changer will shift to the next disc.

The mode returns to normal.

(Factory default)

Press M.I.X. again and select OFF to deactivate the M.I.X. play.

Repeat Play

During playback, press **REPEAT**.

The repeat mode switches each time the button is pressed.

CD

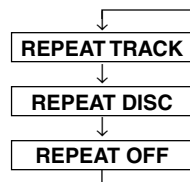

The current track is repeatedly played back.

The entire disc is played repeatedly.

The mode returns to normal.
(Factory default)

MP3/WMA/AAC

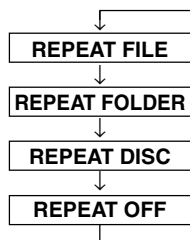

The current file is repeatedly played back.

Only files in a folder are repeatedly played back.

The entire disc is played repeatedly.

The mode returns to normal.
(Factory default)

Press REPEAT again and select OFF to deactivate the repeat play.

- During playback, pressing and holding **REPEAT** for at least 2 seconds will change the unit to **REPEAT OFF**.

Searching Directly by File Number (MP3/WMA/AAC)

Use this function to easily move to the beginning of the file on the disc.

- 1 Except when the unit stops playback, input the number of the file you want to play back by using the numeric keypad ("0" to "9").
- 2 Press **ENT**.
Playback starts from the selected file.

- Depending on the number of digits input, playback may start automatically even if **ENT** is not pressed in step 2.
- Press **CLR** to delete the last digit in the file number.

Recalling a Track/Folder/File Number

- 1 Press **LIST** during playback.
The numeric keypad input mode to be searched is activated.
 - 2 Input the track/folder/file number you want to play back by using the numeric keypad ("0" to "9").
 - 3 Press **ENT**.
Playback starts from the selected track/folder/file number.
- Depending on the input digit number, step 3 may not be necessary.
 - If **LIST** is pressed while in the input mode of the numeric keypad for search, this mode is cancelled.

Displaying a Folder/File List (MP3/WMA/AAC)

If a file from the folder list is selected:

- 1 During playback, press **TOP MENU**.
The folder list in a disc is displayed.
- 2 Press **▲** or **▼** to select the desired folder and press **ENT**.
The file list in the selected folder is displayed.
- 3 Press **▲** or **▼** to select the desired file and press **ENT**.
Playback of the selected file starts.

If a file from the file list is selected:

- 1 During playback, press **MENU**.
The file list in the disc folder is displayed.
 - 2 Press **▲** or **▼** to select the desired file and press **ENT**.
Playback of the selected file starts.
- If a folder name or file name exceeds the display range, the last character that appears in the display range is displayed as "~" (tilde accent).
 - DivX folder/file list is also displayed.

Displaying the Disc Status

Use the procedure described below to display the status (disc number, folder number, etc.) of the currently playing Disc on the monitor screen.

During playback, press **DISPLAY**.

The playback status is displayed.

The playback status display closes when **DISPLAY** is pressed again.

MP3 display example

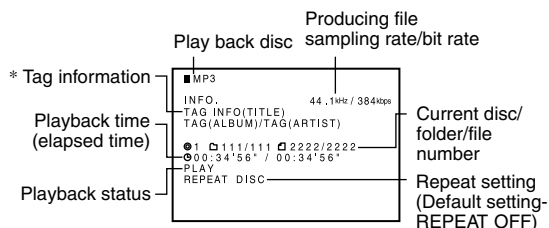

* If file tag information contains in MP3, a song name/album name/artist name is displayed.

About MP3/WMA/AAC

CAUTION

Except for private use, duplicating audio data (including MP3/WMA/AAC data) or distributing, transferring, or copying it, whether for free or for a fee, without permission of the copyright holder is strictly prohibited by the Copyright Act and by international treaty.

What is MP3?

MP3, whose official name is "MPEG-1 Audio Layer 3", is a compression standard prescribed by the ISO, the International Standardization Organization and MPEG which is a joint activity institution of the IEC.

MP3 files contain compressed audio data. MP3 encoding is capable of compressing audio data at extremely high ratios, reducing the size of music files to as much as one-tenth their original size. This is achieved while still maintaining near CD quality. The MP3 format realizes such high compression ratios by eliminating the sounds that are either inaudible to the human ear or masked by other sounds.

What is AAC?

AAC is the abbreviation for "Advanced Audio Coding", and is a basic format of audio compression used by MPEG2 or MPEG4.

What is WMA?

WMA, or "Windows Media™ Audio", is compressed audio data.

WMA is similar to MP3 audio data and can achieve CD quality sound with small file sizes.

Method for creating MP3/WMA/AAC files

Audio data is compressed using software with MP3/WMA/AAC codecs. For details on creating MP3/WMA/AAC files, refer to the user's manual for that software. MP3/WMA/AAC files that can be played back by this device have the following file extensions:

MP3: ".mp3"

WMA: ".wma" (ver. 2, 7 and 8 are supported)

AAC: ".m4a", ".aac"

There are many different versions of the AAC format. Confirm that the software being used conforms to the acceptable formats listed above. It's possible that the format may be unplayable even though the extension is valid. Playback of AAC files encoded by iTunes version 4.8 or earlier is supported.

Supported playback sampling rates and bit rates

MP3

Sampling rates: 44.1 kHz, 32 kHz

Bit rates: 32 - 320 kbps

WMA

Sampling rates: 48 kHz, 44.1 kHz, 32 kHz

Bit rates: 48 - 192 kbps

AAC

Sampling rates: 48 kHz, 44.1 kHz, 32 kHz, 24 kHz, 22.05 kHz, 16 kHz, 12 kHz, 11.025 kHz, 8 kHz

Bit rates: 8 - 320 kbps

This device may not play back correctly depending on sampling rates.

ID3 tags/WMA tags

This device supports ID3 tag v1 and v2, and WMA tag. If tag data is in an MP3/WMA/AAC file, this device can display the title (track title), artist name, and album name ID3 tag/WMA tag data.

This device can only display single-byte alphanumeric characters (up to 30 for ID3 tags and up to 15 for WMA tags) and the underscore. For non-supported characters, the display is blank.

The tag information may not be correctly displayed, depending on the contents.

Producing MP3/WMA/AAC discs

MP3/WMA/AAC files are prepared, then written to a CD-R or CD-RW (DVD-R/DVD-RW) using CD-R writing software. A disc can hold up to 4,096 files/256 folders (including Root Folders). Playback may not be performed if a disc exceeds the limitations described above.

Media supported

The media that this device can play back are CD-ROMs, CD-Rs, CD-RWs, DVD-R and DVD-RW.

Corresponding File Systems

This device supports discs formatted with ISO9660 Level 1 or Level 2.

Under the ISO9660 standard, there are some restrictions to remember.

The maximum nested folder depth is 8 (including the root directory). The number of characters for a folder/file name is limited.

Valid characters for folder/file names are letters A-Z (all caps), numbers 0-9, and '_' (underscore).

This device also can play back discs in Joliet, Romeo, etc., and other standards that conform to ISO9660. However, sometimes the file names, folder names, etc., are not displayed correctly.

Formats supported

This device supports CD-ROM XA, Mixed Mode CD, Enhanced CD (CD-Extra) and Multi-Session. This device cannot correctly play back discs recorded with Track At Once or packet writing.

Order of files

Files are played back in the order that the writing software writes them to the disc. Therefore, the playback order may not be what is expected. Verify the writing order in the software's documentation. The playback order of the folders and files is as follows.

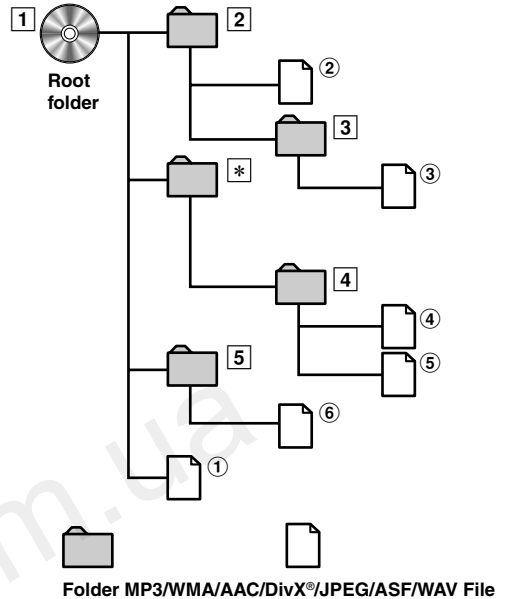

* The folder No./folder Name will not be displayed if no file is contained in the folder.

Terminology

Bit rate

This is the "sound" compression rate specified for encoding. The higher the bit rate, the higher the sound quality, but also the larger the files.

Sampling rate

This value shows how many times per second the data is sampled (recorded). For example, music CDs use a sampling rate of 44.1 kHz, so the sound is sampled (recorded) 44,100 times per second. The higher the sampling rate, the higher the sound quality, but also the larger the volume of data.

Encoding

Converting music CDs, WAVE (AIFF) files, and other sound files into the specified audio compression format.

Tag

Song information such as track title, artist names, album names, etc., written into MP3/WMA/AAC files.

Root folder

The root folder (or root directory) is found at the top of the file system. The root folder contains all folders and files. It is created automatically for all burned discs.

SETUP

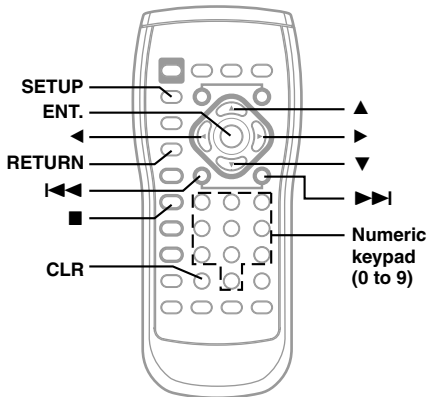

You can flexibly customize the unit to suit your own preferences and usage. From the SETUP menu, System Setting, Audio Setting, etc. can be modified.

Use steps 1 to 4 to select one of the SETUP modes to modify. See the applicable section below for details about the selected SETUP item.

SETUP Operation

You can perform setup operation when disc playback is stopped (**STOP**), or no disc is inserted in the magazine while the car is stopped.

- 1 Press and hold **SETUP** for at least 2 seconds.**
The SETUP menu is displayed.

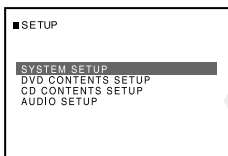

- 2 Press **▲** or **▼** to select the desired setup item, then press **ENT.****

Setting items: SYSTEM SETUP / DVD CONTENTS SETUP / CD CONTENTS SETUP / AUDIO SETUP

- 3 Select setting items or setting contents you want to change in the selected setup by pressing **▲**, **▼**, **◀**, **▶**, and press **ENT.****

Setting items

SYSTEM SETUP:

BACK PICTURE / TV SCREEN(ASPECT / TV SYSTEM) / AUTO DISC CHANGE / VIDEO DELAY / MODEL SETUP / SETUP INITIALIZE

DVD CONTENTS SETUP:

LANGUAGES(AUDIO / SUBTITLE / MENU) / PARENTAL (PASSWORD → COUNTRY CODE / PARENTAL LEVEL / CHANGE PASSWORD) / DVD-A PLAY MODE / DVD-VR PLAY MODE / BONUS CODE / MAIN STORY / AUTO DVD MENU

CD CONTENTS SETUP:

CD PLAY MODE / VCD PLAY MODE / COMPRESS PLAY MODE(PRIORITY MODE) / COMBINATION MODE / JPEG STILL MODE / AUTO DISPLAY / REGISTRATION CODE

AUDIO SETUP:

DIGITAL OUT(DOLBY D/DTS) / DOWNMIX MODE

- 4 After setting, press and hold **SETUP** for at least 2 seconds.**

Save the setting to exit the setting mode.

DVD CONTENTS SETUP

- When settings are changed, old settings are overwritten. Make a note of the current settings before making changes. The settings are not cleared even when the vehicle's battery is disconnected.

Setting the language

The audio language, subtitle language and menu language can be set according to your preferences.

Once set, this becomes the default language. This function is convenient when you always want to listen in English. (Not all discs allow changing the default language. If not, the factory default language applies.)

Setting items: LANGUAGES → AUDIO / SUBTITLE / MENU

AUDIO:

Set the audio track language.

SUBTITLE:

Set the language of the subtitles displayed on the screen.

MENU:

Set the language used for the menus (title menu, etc.).

Setting contents:

AUTO*1 (Initial setting) / **OFF***2 (SUBTITLE only) / **ENGLISH / FRENCH / JAPANESE / ITALIAN / GERMAN / SWEDISH / SPANISH / CHINESE / OTHERS***3

*1 AUTO:

The disc is played with the audio language or subtitle language set as the priority language for the disc.

*2 OFF:

Subtitles are not displayed. (SUBTITLE only)

*3 OTHERS:

Set this to play the disc with a language other than one of the languages displayed. Press **ENT.**, then use the numeric keypad ("0" to "9") to input the 4-digit language code. Then press **ENT.** again. For the language codes, refer to "List of Language Codes" (page 30).

- If you change the language setting when the disc is inside, the setting is decided with one of the following operations.
 - Magazine (disc) eject.
 - Turn OFF the main unit.
 - Switch the source on the head unit.
- To temporarily change the language of the current disc, either do so from the DVD menu or using the operation described in the section "Switching the Audio Tracks" (page 14).
- If the disc does not include the selected language, the disc's default language is set.
- Languages set upon shipment from the factory:
 - Audio language : AUTO
 - Subtitle language : AUTO
 - Menu language : AUTO
- Press **RETURN** to return to the previous display.

Setting the Country Code

Set the country code when setting the rating level (Parental lock).

Setting items: PARENTAL → PASSWORD → COUNTRY CODE

Setting contents: AUTO / OTHERS

AUTO: The country code memorized in the disc is set.

OTHERS: Select this if the desired country code is input.

To change the Country Code:

Use the numeric keypad ("0" to "9") to input the 4-digit country code, then press ENT.

Example: Germany "6869" is input

COUNTRY CODE 6 8 6 9

- If the input code is wrong, "CODE ERROR" is displayed and the unit returns to the setup display again.
- For the country codes, refer to "List of Country Codes" (pages 31 and 32).
- One digit can be erased at a time each time CLR is pressed. Pressing and holding CLR for at least 2 seconds will delete all digits.
- Pressing RETURN will return to the previous screen.

Setting the Rating Level (Parental Lock)

Use this function to restrict the viewing of movies to children of appropriate age levels only.

Setting items: PARENTAL → PASSWORD → PARENTAL LEVEL

Setting contents: OFF (Initial setting) / 8~1

- 1 Use the numeric keypad ("0" to "9") to input the 4-digit password, then press ENT.

Input numbers are displayed as "*."

The default password is 1111 upon shipment from the factory.

The restriction level (PARENTAL LEVEL) input display appears.

- One digit can be erased at a time each time CLR is pressed. Pressing and holding CLR for at least 2 seconds will delete all digits.
- Pressing RETURN will return to the previous screen.
- If the password is wrong, the unit returns to the SETUP display.

- 2 Press ◀, ▶ or ENT. to select the restriction level (8 to 1), then press ENT.

Select "OFF" to cancel the parental lock or if you do not want to set a rating level.

The lower the number, the higher the rating level.

- Press RETURN to return to the previous display.

Change the Password

If you want to change the password, select "CHANGE PASSWORD", then input the new password (4 digits).

Setting items: PARENTAL → PASSWORD → CHANGE PASSWORD

Setting contents: PASSWORD Input

Use the numeric keypad ("0" to "9") to input a 4-digit new password, then press ENT.

- Write down the password on a piece of paper and store the piece of paper somewhere in case you forget it.
- On unrated DVDs, playback will not be restricted even if the rating level is set.
- Once set, this rating level remains in memory until changed. To enable the play of discs of higher rating levels or to cancel the parental lock, the setting must be changed.
- Not all DVDs provide a Parental Lock feature. If you are unsure about a DVD, play it first to confirm. Do not leave DVDs accessible to young children for whom you deem them inappropriate.

Tips

- **Changing the rating level temporarily**
Some discs may request that you change the rating level set in the default settings during playback. In this case, the message appears on the monitor screen "PARENTAL LEVEL CHANGE OK?"
- **To change parental level and play, press ENT.**
- **To play without changing the parental level, press ■.**
(When ■ is pressed, playback will be at the parental level set with "Setting Parental Lock".)

Setting the DVD Audio Playback Mode

To playback the DVD Audio Disc, you have a choice of 3 different settings. If the disc containing DVD Video and Audio, set VIDEO ON or VIDEO OFF to playback the DVD Audio.

Setting item: DVD-A PLAY MODE

Setting contents: DVD-V / DVD-A *

* DVD-A → VIDEO ON (Initial setting) / VIDEO OFF

DVD-V: Plays back the DVD video portion of a disc containing both DVD video/DVD audio.

VIDEO ON: Plays back DVD audio with images also.

VIDEO OFF: Plays back only the audio portion of a DVD audio disc (no image is output).

Setting the DVD-VR Playback Mode

You can set the playback method whether for original Programme DVD-VR disc playback or a playlist edited by another DVD recorder.

Setting item: DVD-VR PLAY MODE

Setting contents: ORG PGC PLAY (Initial setting) / PLAYLIST PLAY

ORG PGC PLAY: Plays back only an original programme.

PLAYLIST PLAY: Plays back only a playlist.

Playing the Bonus Group

In addition to the usual group, DVD Audio also includes an addition Bonus Group. When the Bonus Group is selected, although the password input screen is displayed, you can pre-input a 4-digit password.

Setting item: BONUS CODE

Setting content: BONUS CODE Input

(The initial setting is "0000")

- 1 Press ▲ or ▼ to select "BONUS CODE", then press ENT.
- 2 Use the numeric keypad ("0" to "9") to input 4-digit password, then press ENT.

- One digit can be erased at a time each time CLR is pressed. Pressing and holding CLR for at least 2 seconds will delete all digits.

- 3 When the setting is complete, press and hold SETUP for at least 2 seconds.

The setup returns to normal mode.

- If the Bonus Group password differs from the password in the section you set, the input screen is automatically displayed.

Playing back a Main Story directly

This function skips warnings, precautions, etc., initially displayed when you play back a DVD, and goes straight to the main Story.

Setting item: MAIN STORY

Setting content: OFF (Initial setting) / ON

If you want to play back the main Story directly, set to ON.

- The function may not be available depending on the disc.

Selecting the Button on the Image Screen automatically

You can automatically select the buttons displayed on the top menu/menu image screen by setting time (seconds) without setting manually.

Setting item: AUTO DVD MENU

Setting content: OFF (Initial setting) / SET TIME (1-15 sec)

SET TIME: Set your desired duration (1 to 15 seconds) using the numeric keypad. After the set time has passed, the buttons are automatically selected. (For example, if 8 seconds is set, press 8, and then press ENT.)

SYSTEM SETUP

- When settings are changed, old settings are overwritten. Make a note of the current settings before making changes. The settings are not cleared even when the vehicle's battery is disconnected.

Switching the Background Colour

You can select the background colours from 2 types preset or colour 4 types.

Setting item: BACK PICTURE

Setting contents: TYPE-1 (Initial setting) / TYPE-2 / COLOR *

* COLOR → BLACK / GRAY / BLUE / GREEN

Setting the TV Screen

Use the procedure described below to set the output screen according to the type of TV monitor being used.

Setting items: TV SCREEN → ASPECT

Setting contents: 16:9 (WIDE) (Initial setting) / 4:3 (LETTER BOX) / 4:3 (PAN SCAN)

- For some discs, the picture may not be set to the selected screen size. (For details, refer to the explanation on the disc's jacket.)
- Pressing RETURN will return to the previous screen.

16:9 (WIDE)

Select this when connected to a wide screen TV.

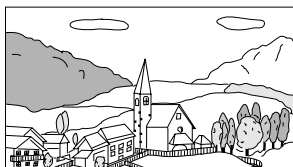

4:3 LB (LETTER BOX)

Select this when connected to a conventional 4:3 size (normal TV aspect ratio) monitor. There may be black bands visible at the top and bottom of the screen (when playing a 16:9 size movie). The width of these stripes will depend upon the original aspect ratio of the theatre release of the movie.



4:3 PAN (PAN SCAN)

Select this when connected to a conventional 4:3 size monitor. The picture will fill the entire TV screen. However, due to the mismatch in aspect ratio, parts of the movie at the extreme left and right sides will not be visible (when playing a 16:9 size movie).

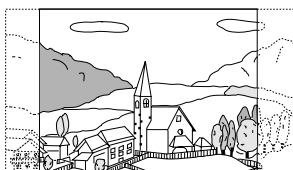

Setting the TV System

You can select the output playback method of an NTSC or PAL signal disc.

Setting items: TV SCREEN → TV SYSTEM

Setting content: MANUAL / AUTO CHANGE (Initial setting) / AUTO SELECT

- MANUAL:** If a playback disc signal differs from the signal system on the connected monitor, "VIDEO SIGNAL SYSTEM IS NOT CORRECT" is displayed.
- AUTO CHANGE:** Image is output by converting the played back disc to the signal system of the monitor.
- AUTO SELECT:** Outputs an image according to the disc signal to be played back. (only when both an NTSC/PAL compatible monitor is connected.)

- * After you have changed the setting from AUTO CHANGE to MANUAL or to AUTO SELECT, or from MANUAL or AUTO SELECT to AUTO CHANGE, turn off the DHA-S690 power. Then when you turn on the power next time, the setting is carried out. When the DHA-S690 power is turned off and on again, perform the following operation.
 - If Ai-NET is not connected: turn off PWR on the remote control and then turn it on again.
 - If Ai-NET is connected: turn off the connected head unit power and then turn it on again, or change the source.
- If you set to AUTO CHANGE, the image may show some deterioration compared to the original.

Setting the Disc Change

When the DVD disc main story playback is finished, the disc will automatically change to the next main story disc.

Setting item: AUTO DISC CHANGE

Setting contents: OFF (Initial setting) / ON

- The function may not be available depending on the disc.

Delaying Image Output

Use this function when an external audio processor is connected. Depending on the connected audio processor, the audio and image currently played back may not be output at the same time. In this case, you can output an image delayed by 0.1 second by setting to ON.

Setting item: VIDEO DELAY

Setting contents: OFF (Initial setting) / ON

ON: Output image is delayed by 0.1 second.

- If a disc with a high compression rate is played back, the image and audio may be distorted.

Setting the Connected Head Unit

The setting is made to output audio from the connected Ai-NET compatible head unit.

Setting item: MODEL SETUP

Setting contents: DVD CHG (Initial setting) / CD CHG

DVD CHG: Set when a head unit sold after January 2008 is connected.

- * Even if the head unit is sold after January 2008, "CD CHG" may or may not be set. Refer to the Owner's Manual of the connected head unit as to whether "CD CHG" or "DVD CHG" should be set.

CD CHG: Set when a head unit sold earlier than December 2007 is connected.

After the setting is complete, turn the ignition key off and on again.

- If this setting is switched, you should reset. Refer to "Initial System Start-Up" (page 9).
- To recall the IVA-D105R, etc. image, switch the VISUAL button on the IVA-D105R.
- Depending on the connected Ai-NET compatible head unit, even though an Ai-NET is set to CD CHG, available functions or displays may vary.

Returning to the Initial Setting

You can return the contents you previously set to the initial factory settings.

Setting item: SETUP INITIALIZE

Setting contents: YES / NO

YES: Returns to the initial setting.

NO: Does not return to the initial setting.

CD CONTENTS SETUP

- When settings are changed, old settings are overwritten. Make a note of the current settings before making changes. The settings are not cleared even when the vehicle's battery is disconnected.

Playing MP3/WMA/AAC/DivX® Data

Setting item: CD PLAY MODE

Setting contents: CD-DA / COMPRESS (Initial setting)

This unit can play back CDs containing both CD and MP3/WMA/AAC/DivX® data (created in Enhanced CD (CD Extra) format).

CD-DA: Only CD data can be played back.

COMPRESS: Only MP3/WMA/AAC/DivX® data can be played back.

Setting the Video CD Play Mode

When playing a Playback Control (PBC) enabled video CD, you can choose to set PBC ON or OFF.

Setting item: VCD PLAY MODE

Setting contents: PBC ON (Initial setting) / PBC OFF

PBC ON: The PBC menu is displayed.

PBC OFF: The PBC menu is not displayed.

Setting Compression Playback Data

If a disc contains both video and audio compression files, you can set to play back only video or audio.

Setting items: COMPRESS PLAY MODE → PRIORITY MODE

Setting contents: ALL (Initial setting) / AUDIO ONLY / VIDEO ONLY

ALL: Plays back audio and video in the recorded sequence.

AUDIO ONLY: Identifies and plays an MP3/WMA/AAC file.

VIDEO ONLY: Identifies and plays a DivX®/JPEG/ASF file.

Setting Playback simultaneously

The function allows you to play back a JPEG still screen along with attached audio.

Setting items: COMPRESS PLAY MODE → COMBINATION MODE

Setting contents: OFF (Initial setting) / AUDIO WITH JPEG * / JPEG WITH AUDIO *

OFF: The function is set to OFF.

AUDIO WITH JPEG: Plays back an audio file simultaneously attached to a JPEG (still screen) file. When the audio file is played back, only the audio file is counted as a file number.

JPEG WITH AUDIO: Plays back a JPEG (still screen) file simultaneously attached with an audio file. When the JPEG file is played back, only the JPEG file is counted as a file number.

Setting contents: * AUDIO WITH JPEG → NORMAL / RANDOM

*** JPEG WITH AUDIO → NORMAL / RANDOM**

NORMAL: Plays in the disc's track order.

RANDOM: Played back the disc randomly.

Setting Time for Still Image Playback

If you set playback time for still image (JPEG file), images are continuously played back (slide show).

Setting items: COMPRESS PLAY MODE → JPEG STILL MODE

Setting contents: MANUAL / SET TIME (1~120 sec)

(The initial setting is 5 sec)

MANUAL: Plays back with still image. Pressing ◀◀ or ▶▶ will play back the next JPEG file, or return to the previous JPEG file.

SET TIME: Using the numeric keypad input, you can set playback time between 1 and 120 seconds (slide show playback).

Setting the Display

The disc usage conditions described in "Displaying the Disc Status" (pages 15, 17) are displayed on the wallpaper, or the upper part of the image during playback. (Except DVD video, DVD audio, DVD-VR, Video CD)

Setting item: AUTO DISPLAY

Setting contents: OFF / ON (Initial setting)

OFF: Usage status is not displayed.

ON: When a disc is played back, usage status of the disc to be played back is displayed on the wallpaper or in the upper part of the image.

(When DivX®, JPEG or ASF discs are played back, the disc status is displayed for 3 seconds.)

Displaying the DivX® registration code (DivX)

Displays the registration code and support version of the DivX®.

Setting item: REGISTRATION CODE

- Selecting "RETURN" on the registration setting screen will return the previous display.

AUDIO SETUP

- When settings are changed, old settings are overwritten. Make a note of the current settings before making changes. The settings are not cleared even when the vehicle's battery is disconnected.

Setting the Digital Output

Use the following procedure to set the digital audio signal output from the DHA-S690.

Setting item: DIGITAL OUT

Output Modes: DOLBY D / DTS

DOLBY D: Sets Dolby Digital output.

The initial setting is BITSTREAM.

DTS: Sets DTS output.

The initial setting is BITSTREAM.

Setting contents: BITSTREAM / LPCM

BITSTREAM: The digital output is switched automatically according to the type of audio signal being played.

Be sure to select "BITSTREAM" when you want to connect a digital audio processor and play Dolby Digital audio. "BITSTREAM" is selected upon shipment from the factory.

LPCM: The audio signal recorded on the disc is converted to 48 kHz/16 bit (for DVDs) or 44.1 kHz (for video CDs and CDs) linear PCM audio signals for output.

- Pressing RETURN will return to the previous screen.

Audio output/Optical digital audio output

Disc	Audio recording format		Digital output setting (DVD SETUP)	Optical digital audio output	Analog audio output (Ai-NET, RCA output)
	Format	Fs			
LPCM (CD-DA, DVD-V, DVD- A, DVD-VR)	44.1/88.2/ 176.4 kHz	16/20/24 bit	BITSTREAM or LPCM	44.1 kHz, 16 bit, LPCM 2 ch (2 ch Downmix)*	OK
	48/96/192 kHz	16/20/24 bit	BITSTREAM or LPCM	48 kHz, 16 bit, LPCM 2 ch (2 ch Downmix)*	OK
PPCM (DVD-A)	44.1/88.2/ 176.4 kHz	16/20/24 bit	BITSTREAM or LPCM	Not output	OK
	48/96/192 kHz	16/20/24 bit			
Dolby Digital (-EX) (DVD-V, DVD- A, DVD-VR)	48 kHz	16/18/20 bit	LPCM	48 kHz, 16 bit, Decoded 2 ch (2 ch Downmix)*	OK
			BITSTREAM	Bit stream (Max 7.1 ch)*	OK
DTS (-ES) (CD-DA, DVD-V, DVD- A)	44.1 kHz	16/20/24 bit	LPCM	44.1 kHz, 16 bit Decoded 2 ch (2 ch Downmix)*	OK
			BITSTREAM	Bit steam (Marx 6.1 ch)*	OK
	48/96 kHz	16/20/24 bit	LPCM	48 kHz, 16 bit, Decoded 2 ch (2 ch Downmix)*	OK
			BITSTREAM	Bit stream (Max 6.1 ch)*	OK
MPEG1Layer II (VCD, DVD-V, DVD-A, DVD- VR)	44.1 kHz	16 bit	LPCM or BITSTREAM	44.1 kHz, 16 bit, Decoded 2 ch*	OK
	48 kHz	16 bit	LPCM or BITSTREAM	48 kHz, 16 bit, Decoded 2 ch (2 ch Downmix)*	OK
MPEG2Layer II (DVD-V, DVD- A, DVD-VR)	44.1 kHz	16 bit	LPCM or BITSTREAM	44.1 kHz, 16 bit, Decoded 2 ch*	OK
	48 kHz	16 bit	LPCM or BITSTREAM	48 kHz, 16 bit, Decoded 2 ch (2 ch Downmix)*	OK
MP3 (MPEG1/ 2/2.5Layer III) AAC, WMA	32 kHz	16 bit	BITSTREAM or LPCM	32 kHz, 16 bit, Decoded 2 ch	OK
	44.1 kHz	16 bit	BITSTREAM or LPCM	44.1 kHz, 16 bit, Decoded 2 ch	OK
	48 kHz	16 bit	BITSTREAM or LPCM	48 kHz, 16 bit, Decoded 2 ch	OK

* Not output when playing back a DVD-Audio.

- BITSTREAM does not output when MPEG audio is set.

Setting the Downmix Mode

This function applies to Dolby Digital, DTS stream sound.

Setting item: DOWNMIX MODE

**Setting contents: STEREO / SURROUND ENCODED
(Initial setting)**

STEREO: Stereo Downmix.

SURROUND ENCODED: Surround compatible Downmix.

Other Useful Features

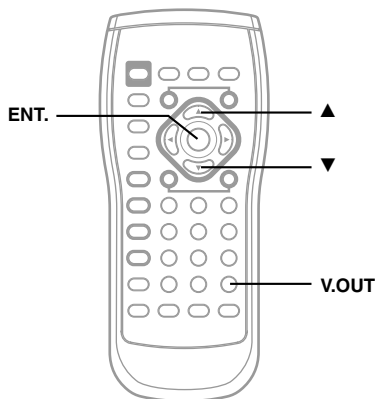

To Output DVD Video While Listening to Another Source (CD/radio, etc.) (only when using Ai-NET)

When the DHA-S690 is connected to an Ai-NET compatible head unit or Ai-NET compatible AV head unit, DVD video can be output independently on the monitor.

If the rear monitor is connected, DVD video and audio can be output independently on the rear monitor.

For example, DVD video can be output on the front or rear monitor, while listening to the CD/radio from the head unit.

- 1 Change the source on the head unit or AV head unit to CD or radio, etc.**
- 2 Select the DVD image from this unit with the V.SEL (VISUAL) (use the Simultaneous Function) on the AV head unit or front monitor.**
- 3 Press V.OUT on the remote control for this unit.**
You can watch the DVD/video CD.
- 4 After using this function, press and hold V.OUT for at least 2 seconds to deactivate the video output mode.**

To watch the DVD on the rear monitor

- 5 See "Rear Monitor Select Function (AUX OUT)" in the AV head unit or front monitor's owner's manual to select the DVD image from this unit.**

Caution

If the power or the ignition key is turned off without canceling the video output mode, the set will start up in the video output mode the next time the power is turned on, and the DHA-S690's power will remain on even if the source is switched with the head unit/AV head unit or if you try to turn off the power of the DHA-S690. If this happens, press and hold V.OUT for at least 2 seconds to cancel the video output mode.

- If the monitor has no rear monitor select function, the rear monitor cannot be connected.
- Buttons to operate, etc., vary depending on the product. Refer to the owner's manual of the connected product for details.

Setting the Wallpaper

A data file downloaded from the ALPINE Owner's website is written to a CD-R/CD-RW disc, and the disc is inserted into the DHA-S690, and then is saved in either "AREA 1" or "AREA 2".

The wallpaper file can be saved and displayed as long as a disc is not inserted (in the magazine), or while playing a CD/MP3/WMA/AAC audio, or if a DVD disc is stopped.

- If several files are stored in a disc, only the first file will be stored on the unit.

- 1 Load a CD-R/CD-RW disc containing data in the magazine.**
The UPDATE screen is displayed.
- 2 Press ▲ or ▼ to select an area (AREA 1 or AREA 2) you want to save, and then press ENT.**
A wallpaper is saved in the selected AREA.
- 3 If you want to change the wallpaper, press and hold ENT. for at least 2 seconds while the unit is stopped.**
 - Up to 2 files can be stored on this unit. If the 3rd file is downloaded, the first file is overwritten and new one memorized.
 - To change the wallpaper, press and hold ENT. for at least 2 seconds while no disc is inserted (in the magazine), or while STOP is set in disc mode.
 - Even if the battery power cable is disconnected, the downloaded data is not cleared.

Operating from the Head Unit

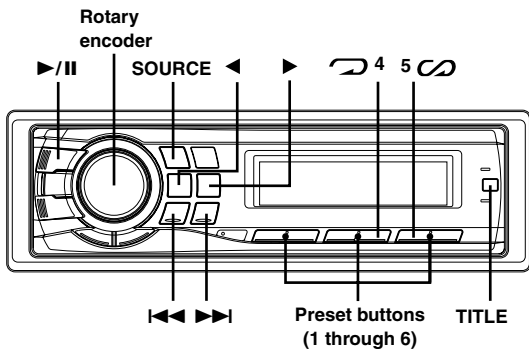

CDA-9885R (Head unit)

The DHA-S690 can also be operated from the ALPINE Ai-NET compatible head unit.

Refer to the manual of the head unit.

Note that some of the functions cannot be operated from the DHA-S690.

Functions operable from the head unit

Switch	Operation
SOURCE	Switches the audio source. Turns the DHA-S690 power ON in the DVD changer or CD changer mode. Turns OFF in a mode other than main DVD changer or CD changer.
TITLE	Switches the display pattern of the head unit.
	Repeat switching.
	CD/MP3/WMA/AAC: M.I.X. play switching.
	Starts playback from the beginning of the following chapter/track. When pressed and held on, fast-forwards the disc.
	Starts playback from the beginning of the current chapter/track. When pressed and held on, fast-reverses the disc.
	Switches between play and pause.
	MP3/WMA/AAC: Returns to the previous folder.
	MP3/WMA/AAC: Forwards to the next folder.
1~6	Changes the disc.
Rotary encoder	Adjusts the volume.

Playing DVDs, video CDs, CDs and MP3/WMA/AAC

1 Press **SOURCE** to select the DVD changer or CD changer mode.

DVD changer or CD changer mode:

The power of the DHA-S690 turns ON and playback starts automatically.

Other modes:

The power of the DHA-S690 turns off automatically.

2 To set the pause mode, press **▶/||**.

Press **▶/||** again to resume playback.

- For video CDs with playback control (PBC), turn PBC off.
- The disc name, track name, and other information can be displayed on the display of the head unit for music CDs that support CD text. This can only be used with alphanumeric text. For details, refer to the Owner's Manual of the head unit.
- In the case of MP3/WMA/AAC, tag information (disc/artist name etc.) can be displayed. Refer to the Owner's Manual of the head unit for details. Tag information cannot be displayed on some head units.

Remote Control

Controls on Remote Control

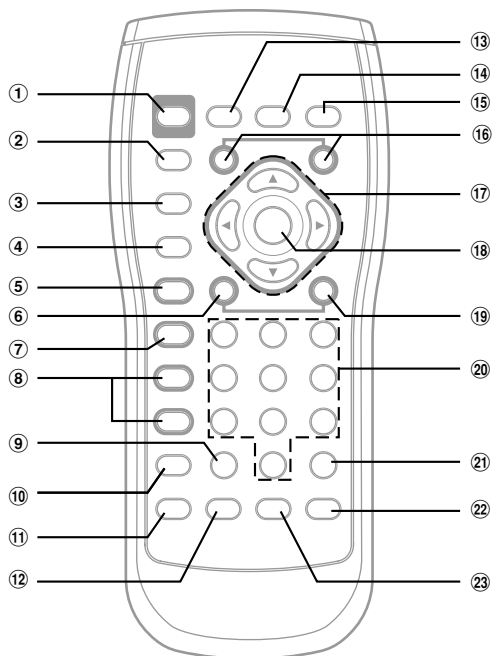

- ① PWR button**
Turns the power ON and OFF. (When Ai-NET non-compatible head unit is connected.)
Press and hold for at least 2 seconds to switch between NTSC/PAL.
- ② SETUP button**
Pressing and holding this button for at least 2 seconds will display the SETUP (initial setting) screen.
- ③ LIST button**
Pressing this button will change to the numeric keypad input mode to be searched.
Pressing and holding for at least 2 seconds will recall the disc list display.
- ④ RETURN button**
Returns to the selection screen just prior to the current screen.
- ⑤ ►/II button**
Switches between play and pause.
- ⑥ ◀◀ button**
CD: Press the button to go back to the beginning of the current track. Press and hold to fast reverse.
MP3/WMA/AAC: Press the button to go back to the beginning of the current file.
DVD/Video CD:
 - Move to the desired position on the disc.
 - During playback, press and hold for more than 1 second to reverse the disc at double speed. Hold for more than 5 seconds to reverse the disc at 8 times the normal speed. Hold for more than 10 seconds to reverse the disc at 32 times the normal speed.
 - When pressed and held on while in the pause mode, the disc is played in reverse slow motion at 1/8th the normal speed. When held in for 5 more seconds, the reverse slow motion speed switches to 1/2 the normal speed (only DVD Video).
 - During pause, each time press once is played back frame by frame (only DVD Video).

- ⑦ ■ button**
Performs stop.
DVD/Video CD: Pressing once sets the PRE-STOP; Pressing twice sets stop.
- ⑧ DISC ▲/▼ button.**
Selects a disc.
- ⑨ CLR (ALL CLR) button**
Removes numbers (one character at a time) that have been selected and input.
Press and hold for 2 seconds. All the characters which were selected and input are erased.
- ⑩ REPEAT button**
Repeats playback.
Pressing and holding for at least 2 seconds will turn off the REPEAT mode.
- ⑪ M.I.X. button**
M.I.X. play for CDs and MP3/WMA/AAC/DivX®.
- ⑫ AUDIO button**
Video CD: Switches the audio output.
DVD: Switches the audio language.
- ⑬ DISPLAY button**
Displays playback status on the screen.
- ⑭ MENU button**
MP3/WMA/AAC/DivX®: Displays FILE menu list.
DVD:
 - Shows the menu display (DVD Video only).
 - Shows the playlist list screen (DVD-VR only).
- ⑮ TOP MENU button**
MP3/WMA/AAC/DivX®: Displays FOLDER menu list.
DVD:
 - By pressing, shows the menu display (DVD Video, DVD Audio only).
 - By pressing, shows the programme list screen (DVD-VR only).
- ⑯ FOLDER UP/DN button**
MP3/WMA/AAC: Switches folder UP/DN.
DVD: Switches Group/Title/Playlist/Programme/UP/DN.
Selects a disc by pressing and holding for at least 2 seconds.
- ⑰ ▲, ▼, ◀, ▶**
Selects the items displayed on the screen.
- ⑱ ENT. button**
Determines the selected item.

19 ►►| button

CD: Press the button to advance to the beginning of the next track. Press and hold to fast forward.

MP3/WMA/AAC: Press the button to advance to the beginning of the next file.

DVD/Video CD:

- Move to the desired position on the disc.
- During playback, press and hold for more than 1 second to forward the disc at double speed. Hold for more than 5 seconds to forward the disc at 8 times the normal speed. Hold for more than 10 seconds to forward the disc at 32 times the normal speed.
- When pressed and held on while in the pause mode, the disc is played in slow motion at 1/8th the normal speed. When held for 5 more seconds, the slow motion speed switches to 1/2 the normal speed (DVD-Video, DVD-VR, Video CD only).
- The picture is forwarded by one frame each time the button is pressed in the pause mode (DVD-Video, DVD-VR, Video CD only).

20 Numeric Keypad

Input numbers.

Pressing and holding any one of the buttons ("1" through "6") for at least 2 seconds will directly change to the disc number 1 to 6.

DVD Audio (VIDEO ON Mode):

- Press and hold the "7" button for at least 2 seconds to forward the page.
- Press and hold the "8" button for at least 2 seconds to reverse the page.
- Press and hold the "9" button for at least 2 seconds to display the home page.

21 V.OUT button

Outputs the DVD video to the monitor when in other source. (only when Ai-NET is connected)

Pressing and holding for at least 2 seconds will forcibly cancel the simultaneous function.



22 ANGLE button

DVD Video/DVD Audio (VIDEO ON Mode):

Changes the image angle.

23 SUBTITLE button

DVD: Switches the subtitle.

- Operation may not be possible depending on the type of disc and the playback conditions. At such a time the following mark is displayed on the screen: 
(When the red  indicator is displayed, disc operation is prohibited. When the white  indicator is displayed, unit playback is prohibited.)

Information

About DVDs

Music CDs and DVDs have grooves (tracks) in which the digital data is recorded. The data is represented as microscopic pits recorded into the track – these pits are read by a laser beam to play the disc. On DVDs, the density of the tracks and pits is twice that of CDs, so DVDs can contain more data in less space.

CDs

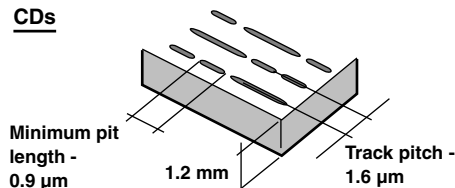

DVDs

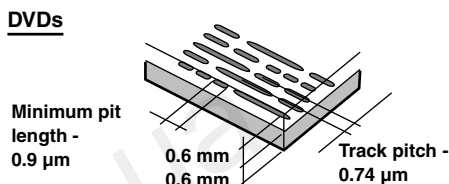

A 12 cm disc can contain one movie or about four hours of music. In addition, DVDs provide sharp picture quality with vivid colours thanks to a horizontal resolution of over 500 lines (compared to less than 300 for VHS tape). With the addition of an optional, digital audio processor (PXA-H701, etc.), you can recreate the power and presence of a movie theatre with Dolby Digital 5.1-channel Surround.

In addition, DVDs offer a variety of functions.

• Multiple audio* (page 14)

Movies can be recorded in up to eight languages. The desired language can be selected from the remote control.

• Subtitles function* (page 15)

Movies can include subtitles in up to 32 languages. The desired subtitle language can be selected from the remote control.

• Multi angle function* (page 14)

When the DVD contains a movie shot from multiple angles, the desired angle can be selected from the remote control.

• Multi story function*

With this function, a single movie includes various story lines. You can select different story lines to view various versions of the same movie.

Operation differs from disc to disc. Story line selection screens including instructions appear during the movie. Just follow the instructions.

* The functions, audio languages, subtitle languages, angles, etc., differ from disc to disc. For details, refer to the disc's instructions.

About DivX®

DivX® is a codec (software) programme to compress moving images while maintaining image quality using a highly advanced compression ratio and operating speed.

- Official DivX® Certified product.
- Plays all versions of DivX® video (including DivX® 5) with standard playback of DivX® media files.
- DivX, DivX Certified, and associated logos are trademarks of DivX, Inc. and are used under license.

The unit can play back CD-R/CD-RW/DVD-R/DVD-RW/DVD+R/DVD+RW discs that are recorded in the DivX® mode with extension "avi" or "divx".

The optimum size for DivX® disc playback is as follows:

Screen Size: 32 to 720 pixel (horizontal) × 32 to 480 pixel (vertical) (NTSC)

720 pixel (horizontal) × 576 pixel (vertical) (PAL).

Image bit rate: "average 4 Mbps, Peak 8 Mbps"
Home Theatre Profile supported.

The following audio recording systems are supported.

MPEG1 Layer II 64 to 384 kbps

MPEG1 Layer III 32 to 320 kbps

MPEG2 Layer III 8 to 160 kbps

Dolby Digital 64 to 448 kbps (Max. 5.1ch)

About JPEG

JPEG (Joint Photographic Experts Group) is a compression standard still colour images.

- Method: Baseline
- Extension: ".jpg", ".jpeg", ".jpe"
- Screen Size: horizontal 32 to 8,192 pixel × vertical 32 to 7,680 pixel
- Format: JFIF, EXIF supported (TIFF not supported)
- Colour: YCbCr, RGB signal (24 bit) (CMYK not supported)

About WAV

WAV, whose official name is "WAVE FORMAT" is a standard format of Windows® audio file.

- Extension: ".wav"
- Sampling rate: 44.1 kHz
- Quantization bit number: 16
- Channel number: up to 2ch
- Format: PCM only

About ASF

ASF (Advanced Streaming Format) is a file format developed by Microsoft to deliver streaming synchronized data of a wide variety (animation, audio or text, etc.) via networks.

- Extension: ".asf"
- Screen Size: horizontal 32 to 720 pixel × vertical 32 to 480 pixel (NTSC)
 - * The size above CIF is currently not available
horizontal 720 pixel × vertical 576 pixel (PAL)
- Image bit rate (maximum): 384 kbps (SP L3 standard)
(minimum value not given)
- The following image files are supported: ISO-MPEG4 (MP4S/M4S2)
- The following audio files are supported: G.726 (Fs:8 kHz, Bitrate:16,24,32,40)
- ASP: still not available (GMC is not supported, QuarterPixel is supported)
- SP: supported

Terminology

Dolby Digital

Dolby Digital is a digital audio compression technology developed by Dolby Laboratories that allows large quantities of audio data to be efficiently recorded on discs. It is compatible with audio signals from mono (1 channel) all the way up to 5.1-channel surround sound. The signals for the different channels are completely independent, and since the sound is high quality digital there is no loss of sound quality.

* *The separately sold digital audio processor (PXA-H701, etc.) is required to enjoy full 5.1-channel surround sound.*

The DHA-S690 performs Dolby Digital decoding when it outputs analog audio signals; 2-channel audio, not 5.1-channel.

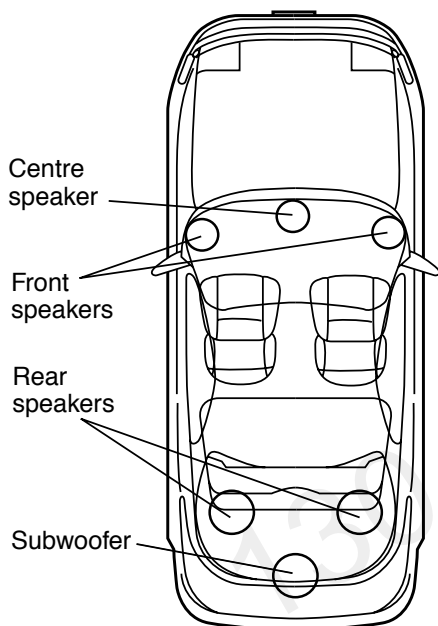

Speaker layout for enjoying Dolby Digital sound/DTS sound

DTS

This is a home-use digital sound format of the DTS Sound System. This is a high quality sound system, developed by DTS, Inc. for use in movie theatres.

DTS has six independent sound tracks. The theatre presentation is fully realized in the home, etc. DTS is the abbreviation for Digital Theatre System.

* *To enjoy DTS surround sound you need the separately sold DTS digital audio processor (PXA-H701, etc.). The DVD video software must also have a DTS sound track.*

The DHA-S690 has a built-in DTS 2-channel audio decoder. Analog audio outputs are available.

Dolby Pro Logic

Dolby Pro Logic is the technology used to decode programmes encoded in Dolby Surround. Pro Logic decoding will provide you with four channels of sound (front left/right, centre and monaural rear surround) from a 2-channel (stereo) source.

* *The separately sold digital audio processor (PXA-H701, etc.) is required to enjoy Dolby Pro Logic surround sound.*

Dolby Pro Logic II

Dolby Pro Logic II plays 2-channel sources in 5 channels over the entire frequency range.

This is done with an advanced, high sound quality matrix surround decoder which draws out the spatial properties of the original recording without adding any sounds to or changing the sound of the source.

* *The separately sold digital audio processor (PXA-H701, etc.) is required to enjoy Dolby Pro Logic II surround sound.*

Linear PCM audio (LPCM)

LPCM is a signal recording format used for music CDs. Whereas music CDs are recorded at 44.1 kHz/16 bits, DVDs are recorded at 48 kHz/16 bits to 96 kHz/24 bits, thereby achieving higher sound quality than music CDs.

Rating levels (parental lock)

This is a DVD function for restricting the viewing age as stipulated by censorship laws in different countries. The way in which viewing is restricted differs from DVD to DVD. Sometimes the DVD cannot be played at all, other times certain scenes are skipped, and other times certain scenes are replaced with other scenes.

List of Language Codes

(For details, see page 19.)

Abbreviation	Code	Language	Abbreviation	Code	Language	Abbreviation	Code	Language
AA	6565	Afar	IE	7369	Interlingue	RN	8278	Kirundi
AB	6566	Abkhazian	IK	7375	Inupiak	RO	8279	Romanian
AF	6570	Afrikaans	IN	7378	Indonesian	RU	8285	Russian
AM	6577	Amharic	IS	7383	Icelandic	RW	8287	Kinyarwanda
AR	6582	Arabic	IT	7384	Italian	SA	8365	Sanskrit
AS	6583	Assamese	IW	7387	Hebrew	SD	8368	Sindhi
AY	6589	Aymara	JA	7465	Japanese	SG	8371	Sangho
AZ	6590	Azerbaijani	JI	7473	Yiddish	SH	8372	Serbo-Croatian
BA	6665	Bashkir	JW	7487	Javanese	SI	8373	Singhalese
BE	6669	Byelorussian	KA	7565	Georgian	SK	8375	Slovak
BG	6671	Bulgarian	KK	7575	Kazakh	SL	8376	Slovenian
BH	6672	Bihari	KL	7576	Greenlandic	SM	8377	Samoan
BI	6673	Bislama	KM	7577	Cambodian	SN	8378	Shona
BN	6678	Bengali, Bangla	KN	7578	Kannada	SO	8379	Somali
BO	6679	Tibetan	KO	7579	Korean	SQ	8381	Albanian
BR	6682	Breton	KS	7583	Kashmiri	SR	8382	Serbian
CA	6765	Catalan	KU	7585	Kurdish	SS	8383	Siswati
CO	6779	Corsican	KY	7589	Kirghiz	ST	8384	Sesotho
CS	6783	Czech	LA	7665	Latin	SU	8385	Sundanese
CY	6789	Welsh	LN	7678	Lingala	SV	8386	Swedish
DA	6865	Danish	LO	7679	Laothian	SW	8387	Swahili
DE	6869	German	LT	7684	Lithuanian	TA	8465	Tamil
DZ	6890	Bhutani	LV	7686	Latvian, Lettish	TE	8469	Telugu
EL	6976	Greek	MG	7771	Malagasy	TG	8471	Tajik
EN	6978	English	MI	7773	Maori	TH	8472	Thai
EO	6979	Esperanto	MK	7775	Macedonian	TI	8473	Tigrinya
ES	6983	Spanish	ML	7776	Malayalam	TK	8475	Turkmen
ET	6984	Estonian	MN	7778	Mongolian	TL	8476	Tagalog
EU	6985	Basque	MO	7779	Moldavian	TN	8478	Setswana
FA	7065	Persian	MR	7782	Marathi	TO	8479	Tonga
FI	7073	Finnish	MS	7783	Malay	TR	8482	Turkish
FJ	7074	Fiji	MT	7784	Maltese	TS	8483	Tsonga
FO	7079	Faroese	MY	7789	Burmese	TT	8484	Tatar
FR	7082	French	NA	7865	Nauru	TW	8487	Twi
FY	7089	Frisian	NE	7869	Nepali	UK	8575	Ukrainian
GA	7165	Irish	NL	7876	Dutch	UR	8582	Urdu
GD	7168	Scots Gaelic	NO	7879	Norwegian	UZ	8590	Uzbek
GL	7176	Galician	OC	7967	Occitan	VI	8673	Vietnamese
GN	7178	Guarani	OM	7977	(Afan) Oromo	VO	8679	Volapuk
GU	7185	Gujarati	OR	7982	Oriya	WO	8779	Wolof
HA	7265	Hausa	PA	8065	Punjabi	XH	8872	Xhosa
HI	7273	Hindi	PL	8076	Polish	YO	8979	Yoruba
HR	7282	Croatian	PS	8083	Pashto, Pushto	ZH	9072	Chinese
HU	7285	Hungarian	PT	8084	Portuguese	ZU	9085	Zulu
HY	7289	Armenian	QU	8185	Quechua			
IA	7365	Interlingua	RM	8277	Rhaeto-Romance			

List of Country Codes

(For details, see page 20.)

Abbreviation	Code	Country	Abbreviation	Code	Country	Abbreviation	Code	Country
AD	6568	Andorra	DM	6877	Dominica	KI	7573	Kiribati
AE	6569	United Arab Emirates	DO	6879	Dominican Republic	KM	7577	Comoros
AF	6570	Afghanistan	DZ	6890	Algeria	KN	7578	Saint Kitts and Nevis
AG	6571	Antigua and Barbuda	EC	6967	Ecuador	KP	7580	Korea, Democratic People's Republic of
AI	6573	Anguilla	EE	6969	Estonia			
AL	6576	Albania	EG	6971	Egypt	KR	7582	Korea, Republic of
AM	6577	Armenia	EH	6972	Western Sahara	KW	7587	Kuwait
AN	6578	Netherlands Antilles	ER	6982	Eritrea	KY	7589	Cayman Islands
AO	6579	Angola	ES	6983	Spain	KZ	7590	Kazakhstan
AQ	6581	Antarctica	ET	6984	Ethiopia	LA	7665	Lao People's Democratic Republic
AR	6582	Argentina	FI	7073	Finland			
AS	6583	American Samoa	FJ	7074	Fiji	LB	7666	Lebanon
AT	6584	Austria	FK	7075	Falkland Islands	LC	7667	Saint Lucia
AU	6585	Australia	FM	7077	Micronesia, Federated States of	LI	7673	Liechtenstein
AW	6587	Aruba	FO	7079	Faroe Islands	LK	7675	Sri Lanka
AZ	6590	Azerbaijan	FR	7082	France	LR	7682	Liberia
BA	6665	Bosnia and Herzegovina	GA	7165	Gabon	LS	7683	Lesotho
BB	6666	Barbados	GB	7166	United Kingdom	LT	7684	Lithuania
BD	6668	Bangladesh	GD	7168	Grenada	LU	7685	Luxembourg
BE	6669	Belgium	GE	7169	Georgia	LV	7686	Latvia
BF	6670	Burkina Faso	GF	7170	French Guiana	LY	7689	Libyan Arab Jamahiriya
BG	6671	Bulgaria	GH	7172	Ghana	MA	7765	Morocco
BH	6672	Bahrain	GI	7173	Gibraltar	MC	7767	Monaco
BI	6673	Burundi	GL	7176	Greenland	MD	7768	Moldova, Republic of
BJ	6674	Benin	GM	7177	Gambia	MG	7771	Madagascar
BM	6677	Bermuda	GN	7178	Guinea	MH	7772	Marshall Islands
BN	6678	Brunei Darussalam	GP	7180	Guadeloupe	MK	7775	Macedonia, The former Yugoslav Republic of
BO	6679	Bolivia	GQ	7181	Equatorial Guinea			
BR	6682	Brazil	GR	7182	Greece	ML	7776	Mali
BS	6683	Bahamas	GS	7183	South Georgia and the South Sandwich Islands	MM	7777	Myanmar
BT	6684	Bhutan				MN	7778	Mongolia
BV	6686	Bouvet Island	GT	7184	Guatemala	MO	7779	Macau
BW	6687	Botswana	GU	7185	Guam	MP	7780	Northern Mariana Islands
BY	6689	Belarus	GW	7187	Guinea-Bissau	MQ	7781	Martinique
BZ	6690	Belize	GY	7189	Guyana	MR	7782	Mauritania
CA	6765	Canada	HK	7275	Hong Kong	MS	7783	Montserrat
CC	6767	Cocos (Keeling) Islands	HM	7277	Heard Island and McDonald Islands	MT	7784	Malta
CD	6768	Congo, the Democratic Republic of the				MU	7785	Mauritius
CF	6770	Central African Republic	HN	7278	Honduras	MV	7786	Maldives
CG	6771	Congo	HR	7282	Croatia	MW	7787	Malawi
CH	6772	Switzerland	HT	7284	Haiti	MX	7788	Mexico
CI	6773	Cote d'Ivoire	HU	7285	Hungary	MY	7789	Malaysia
CK	6775	Cook Islands	ID	7368	Indonesia	MZ	7790	Mozambique
CL	6776	Chile	IE	7369	Ireland	NA	7865	Namibia
CM	6777	Cameroon	IL	7376	Israel	NC	7867	New Caledonia
CN	6778	China	IN	7378	India	NE	7869	Niger
CO	6779	Colombia	IO	7379	British Indian Ocean Territory	NF	7870	Norfolk Island
CR	6782	Costa Rica	IQ	7381	Iraq	NG	7871	Nigeria
CU	6785	Cuba	IR	7382	Iran, Islamic Republic of	NI	7873	Nicaragua
CV	6786	Cape Verde	IS	7383	Iceland	NL	7876	Netherlands
CX	6788	Christmas Island	IT	7384	Italy	NO	7879	Norway
CY	6789	Cyprus	JM	7477	Jamaica	NP	7880	Nepal
CZ	6790	Czech Republic	JO	7479	Jordan	NR	7882	Nauru
DE	6869	Germany	JP	7480	Japan	NU	7885	Niue
DJ	6874	Djibouti	KE	7569	Kenya	NZ	7890	New Zealand
DK	6875	Denmark	KG	7571	Kyrgyzstan	OM	7977	Oman
			KH	7572	Cambodia	PA	8065	Panama

Abbreviation	Code	Country	Abbreviation	Code	Country	Abbreviation	Code	Country
PE	8069	Peru	SJ	8374	Svalbard and Jan Mayen	TW	8487	Taiwan, Province of China
PF	8070	French Polynesia	SK	8375	Slovakia	TZ	8490	Tanzania, United Republic of
PG	8071	Papua New Guinea	SL	8376	Sierra Leone	UA	8565	Ukraine
PH	8072	Philippines	SM	8377	San Marino	UG	8571	Uganda
PK	8075	Pakistan	SN	8378	Senegal	UM	8577	United States Minor Outlying Islands
PL	8076	Poland	SO	8379	Somalia	US	8583	United States
PM	8077	Saint Pierre and Miquelon	SR	8382	Suriname	UY	8589	Uruguay
PN	8078	Pitcairn	ST	8384	Sao Tome and Principe	UZ	8590	Uzbekistan
PR	8082	Puerto Rico	SV	8386	El Salvador	VA	8665	Holy See (Vatican City State)
PT	8084	Portugal	SY	8389	Syrian Arab Republic	VC	8667	Saint Vincent and the Grenadines
PW	8087	Palau	SZ	8390	Swaziland	VE	8669	Venezuela
PY	8089	Paraguay	TC	8467	Turks and Caicos Islands	VG	8671	Virgin Island, British
QA	8165	Qatar	TD	8468	Chad	VI	8673	Virgin Islands, U.S
RE	8269	Reunion	TF	8470	French Southern Territories	VN	8678	Viet Nam
RO	8279	Romania	TG	8471	Togo	VU	8685	Vanuatu
RU	8285	Russian Federation	TH	8472	Thailand	WF	8770	Wallis and Futuna
RW	8287	Rwanda	TJ	8474	Tajikistan	WS	8783	Samoa
SA	8365	Saudi Arabia	TK	8475	Tokelau	YE	8969	Yemen
SB	8366	Solomon Islands	TM	8477	Turkmenistan	YT	8984	Mayotte
SC	8367	Seychelles	TN	8478	Tunisia	YU	8985	Yugoslavia
SD	8368	Sudan	TO	8479	Tonga	ZA	9065	South Africa
SE	8369	Sweden	TP	8480	East Timor	ZM	9077	Zambia
SG	8371	Singapore	TR	8482	Turkey	ZW	9087	Zimbabwe
SH	8372	Saint Helena	TT	8484	Trinidad and Tobago			
SI	8373	Slovenia	TV	8486	Tuvalu			

130.com.ua

In Case of Difficulty

If you encounter a problem, please turn the power off, then on again. If the unit is still not functioning normally, please review the items in the following checklist. This guide will help you isolate the problem if the unit is at fault. Otherwise, make sure the rest of your system is properly connected or consult your authorized Alpine dealer.

No function or display.

- Vehicle's ignition is off.
 - If connected following the instructions, the unit will not operate with the vehicle's ignition off.
- Improper power lead connections.
 - Check power lead connections.
- Blown fuse.
 - Replace the fuse on the battery lead of the unit with the proper value.

Unable to fast forward or reverse the disc.

- The disc has been damaged.
 - Eject the disc and discard it; using a damaged disc in your unit can cause damage to the mechanism.

Disc playback sound skips due to vibration.

- Improper mounting of the unit.
 - Securely re-mount the unit.
- Disc is very dirty.
 - Clean the disc.
- Disc has scratches.
 - Change the disc.
- The pick-up lens is dirty.
 - Do not use a commercial available lens cleaner disc. Consult your nearest ALPINE dealer.

Disc playback sound skips without vibration.

- Dirty or scratched disc.
 - Clean the disc; damaged disc should be replaced.

CD-R/CD-RW playback not possible.

- Close session (finalization) has not been performed.
 - Perform finalization and attempt playback again.

Error displays

- Mechanical error
 - Press **▲**. After the error indication disappears, insert the magazine again. If the above-mentioned solution does not solve the problem, consult your nearest ALPINE dealer.

MP3/WMA/AAC is not played back.

- Writing error occurred. The CD format is not compatible.
 - Make sure the CD has been written in a supported format. Refer to "About MP3/WMA/AAC" on pages 17-18, then rewrite in the format supported by this device.

Unit does not operate.

- Monitor's power is not turned on.
 - Turn on the monitor's power.
- Condensation.
 - Wait a while (about 1 hour) for the condensation to dry.

No picture is produced.

- Monitor's mode is not switched to the mode you want to see.
 - Switch to the mode you want to see.
- Monitor's parking brake cord is not connected.
 - Connect the monitor's parking brake cord and set the parking brake. (For details, refer to the monitor's instructions.)
- Monitor's parking brake is not set.
 - Connect the monitor's parking brake cord and set the parking brake. (For details, refer to the monitor's instructions.)

Playback does not start.

- Disc is loaded upside-down.
 - Check the disc and load it with the labeled side facing upward.
- Disc is dirty.
 - Clean the disc.
- A disc not able to playback with this unit is loaded.
 - Check if the disc is able to be played back.
- Parental lock is set.
 - Cancel the parental lock or change the rating level.
- Setup menu is displayed.
 - Press and hold **SETUP** for at least 2 seconds to turn the menu off.

Picture is unclear or noisy.

- Disc is being fast-forwarded or fast-reversed.
 - The picture may be unclear, but this is normal.
- Vehicle's battery power is weak.
 - Check the battery power and wiring. (The unit may malfunction if the battery power is under 11 volts with a load applied.)
- Monitor's fluorescent tube is worn out.
 - Replace the monitor's fluorescent tube.

Unable to turn the power off by switching sources on the head unit. (Only when an Ai-NET compatible (AV) head unit is connected.)

- The switched (ignition) power lead for this unit is connected.
 - Do not connect the switched (ignition) power lead for this unit when an Ai-NET compatible (AV) head unit is connected.

Playing back a DRM protected DivX® File

Some operations cannot be performed while displaying the following message.

"Authorization Error"

- If a non-approved DRM protected DivX® file that does not comply with the registration code of the unit is played back, "Authorization Error" is displayed for 2 seconds, meaning the file cannot be played back. After the message has been displayed, the beginning of the next file will automatically be played back.

"Rental Expired"

- There is a rental file in the DivX® that is set to audio/visual times. If audio/visual time is counted as 0, "Rental Expired" is displayed for 2 seconds, indicating that the file cannot be played back. After the message has been displayed, the beginning of the next file will automatically be played back.

"Rental countdown OK?"

- While playing back a rental file, if B.SKIP or ENTER in the file selection menu is selected, "Rental countdown OK?" is displayed, and the rental file playback is interrupted (audio/visual times are reduced by 1). The file has paused (PAUSE) at the time. To interrupt the playback, select [YES], or select [NO] to not be interrupted.

"This rental has (remaining times) views left.

View DivX® VOD Rental?"

- If audio/visual times still remain, the remaining number of playback times is displayed. To play back, select [YES]. If the next file is to be played back, select [NO].

Indication



DISC ERROR

- Mechanism error.
 - 1) Press **▲** and eject the magazine (disc).
If the disc does not eject, press **▲** again for at least 3 seconds and eject the magazine (disc).
If the disc still does not eject, consult your Alpine dealer.
 - 2) When the error indication remains after ejecting, press **▲** again.
If the error indication still does not turn off after pressing **▲** a few times, consult your Alpine dealer.
- The temperature in the car is too low.
 - Raise the temperature in the car to normal temperature.

NO DISC

- No disc is inserted.
 - Insert a disc.



- Remote control operation is not possible.
 - For some discs or playing modes, certain operations are not possible. This is not a malfunction.
(When the red  indicator is displayed, disc operation is prohibited.
When the white  indicator is displayed, unit playback is prohibited.)

REGIONAL CODE VIOLATION

- Disc does not match regional code number.
 - Load a disc that matches the regional code number.

HI-TEMP

- Protective circuit is activated at high temperature.
 - The indicator will disappear when the temperature returns to within operation range.
 - Leave the power OFF until the temperature decreases and then turn the power ON again.

LOADING ERROR

EJECT ERROR

- Mechanism error.
 - 1) Press **▲** and eject the magazine (disc).
If the disc does not eject, turn the power off once and then on again, then press **▲** for at least 3 seconds and eject the magazine (disc).
If the disc still does not eject, consult your Alpine dealer.
 - 2) When the error indication remains after ejecting, press **▲** again.
If the error indication still does not turn off after pressing **▲** a few times, consult your Alpine dealer.

VIDEO SIGNAL SYSTEM IS NOT CORRECT

- Displays if a disc differs from the setting on the device.
 - Sets in "Setting the TV System" (page 21).

Specifications

Frequency Response	
DVD: 5 – 20,000 Hz (\pm 1 dB) (48 kHz sampling)	
CD: 5 – 20,000 Hz (\pm 1 dB)	
Wow & Flutter (% WRMS)	Below measurable limits
Total Harmonic Distortion	0.015%
Dynamic Range	90 dB (at 1 kHz)
Channel Separation	85 dB (at 1 kHz)
Signal system	NTSC/PAL
Horizontal resolution	500 lines or greater
Video output level	1Vp-p (75 ohms)
Video S/N ratio	DVD: 60 dB
Audio S/N ratio	90 dB

PICKUP

Wave length	DVD: 665 nm CD: 785 nm
Laser power	CLASS II

REMOTE CONTROL

Battery Type	CR2025 battery
Width	51 mm (2")
Height	119 mm (4-11/16")
Depth	13 mm (1/2")
Weight	40 g (1.4 oz) (battery excluded)

GENERAL

Power Requirement	14.4 V DC (11–16 V allowable)
Operating Temperature	+14°F to +140°F (-10°C to + 60°C)
Audio Output Level	
Auxout:	1.2V/10k ohms
Ai-NET:	850 mV

CHASSIS SIZE

Width	255 mm (10")
Height	63 mm (2-1/2")
Depth	188.3 mm (7-3/8")
Weight	2.0 kg (4 lbs. 6 oz)

- Due to continuous product improvement, specifications and design are subject to change without notice.

CAUTION

**CLASS 1
LASER PRODUCT**

(Rear side of player)

CAUTION-Laser radiation when open, DO NOT STARE INTO BEAM

(Rear side of player)

130.com.ua

Installation and Connections

Before installing or connecting the unit, please read the following and pages 3 to 4 of this manual thoroughly for proper use.

Warning

MAKE THE CORRECT CONNECTIONS.

Failure to make the proper connections may result in fire or product damage.

USE ONLY IN CARS WITH A 12 VOLT NEGATIVE GROUND.

(Check with your dealer if you are not sure.) Failure to do so may result in fire, etc.

BEFORE WIRING, DISCONNECT THE CABLE FROM THE NEGATIVE BATTERY TERMINAL.

Failure to do so may result in electric shock or injury due to electrical shorts.

DO NOT SPLICE INTO ELECTRICAL CABLES.

Never cut away cable insulation to supply power to other equipment. Doing so will exceed the current carrying capacity of the wire and result in fire or electric shock.

DO NOT DAMAGE PIPE OR WIRING WHEN DRILLING HOLES.

When drilling holes in the chassis for installation, take precautions so as not to contact, damage or obstruct pipes, fuel lines, tanks or electrical wiring. Failure to take such precautions may result in fire.

DO NOT USE BOLTS OR NUTS IN THE BRAKE OR STEERING SYSTEMS TO MAKE GROUND CONNECTIONS.

Bolts or nuts used for the brake or steering systems (or any other safety-related system), or tanks should NEVER be used for installations or ground connections. Using such parts could disable control of the vehicle and cause fire etc.

KEEP SMALL OBJECTS SUCH AS BATTERIES OUT OF THE REACH OF CHILDREN.

Swallowing them may result in serious injury. If swallowed, consult a physician immediately.

DO NOT INSTALL IN LOCATIONS WHICH MIGHT HINDER VEHICLE OPERATION, SUCH AS THE STEERING WHEEL OR SHIFT LEVER.

Doing so may obstruct forward vision or hamper movement etc. and results in serious accident.

Caution

HAVE THE WIRING AND INSTALLATION DONE BY EXPERTS.

The wiring and installation of this unit requires special technical skill and experience. To ensure safety, always contact the dealer where you purchased this product to have the work done.

USE SPECIFIED ACCESSORY PARTS AND INSTALL THEM SECURELY.

Be sure to use only the specified accessory parts. Use of other than designated parts may damage this unit internally or may not securely install the unit in place. This may cause parts to become loose resulting in hazards or product failure.

ARRANGE THE WIRING SO IT IS NOT CRIMPED OR PINCHED BY A SHARP METAL EDGE.

Route the cables and wiring away from moving parts (like the seat rails) or sharp or pointed edges. This will prevent crimping and damage to the wiring. If wiring passes through a hole in metal, use a rubber grommet to prevent the wire's insulation from being cut by the metal edge of the hole.

DO NOT INSTALL IN LOCATIONS WITH HIGH MOISTURE OR DUST.

Avoid installing the unit in locations with high incidence of moisture or dust. Moisture or dust that penetrates into this unit may result in product failure.

Precautions

- Be sure to disconnect the cable from the (-) battery post before installing your DHA-S690. This will reduce any chance of damage to the unit in case of a short-circuit.
- Be sure to connect the colour coded leads according to the diagram. Incorrect connections may cause the unit to malfunction or damage to the vehicle's electrical system.
- When making connections to the vehicle's electrical system, be aware of the factory installed components (e.g. on-board computer). Do not tap into these leads to provide power for this unit. When connecting the DHA-S690 to the fuse box, make sure the fuse for the intended circuit of the DHA-S690 has the appropriate amperage. Failure to do so may result in damage to the unit and/or the vehicle. When in doubt, consult your ALPINE dealer.
- The DHA-S690 uses female RCA-type jacks for connection to other units (e.g. amplifier) having RCA connectors. You may need an adaptor to connect other units. If so, please contact your authorized ALPINE dealer for assistance.

IMPORTANT

Please record the serial number of your unit in the space provided below and keep it as a permanent record. The serial number plate is located on the bottom of the unit.

SERIAL NUMBER: _____
INSTALLATION DATE: _____
INSTALLATION TECHNICIAN: _____
PLACE OF PURCHASE: _____

Preparation

- 1 Park the vehicle in a flat, safe place. Apply the parking brake, then remove the ignition key.**
- 2 Check the included parts and organize the tools and installation instructions.**

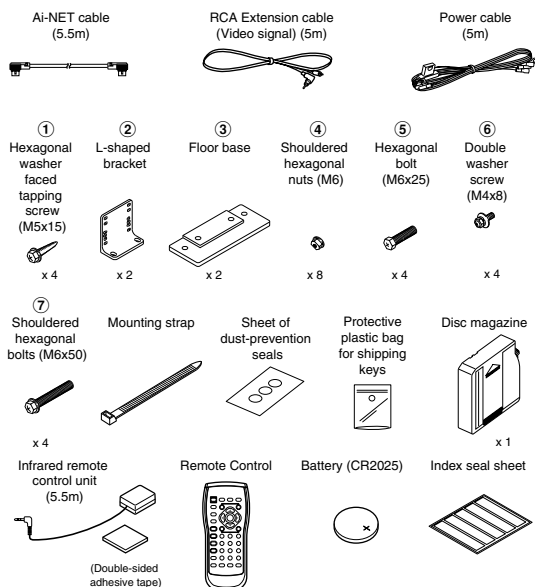

- 3 Disconnect the battery's minus terminal.**

Connecting

- 1 Connect as described on the basic connection diagram on page 40.**
 - These instructions also include examples of connections with other products. (See pages 41 to 43.)
 - Check which combination of products you will be using and proceed accordingly.
- 2 Check that all connections are correct.**
- 3 Connect the battery's minus terminal.**
- 4 Turn ignition key on and power on the head unit, and switch a source to DVD changer or CD changer, then make sure sound will output correctly.**
 - Before fixing, make sure the function works. If the function does not work correctly, check the connection again.
- 5 Turn off the DHA-S690's power.**

- 6 Remove the ignition key and disconnect the battery's minus terminal.**

- Press the Reset button when using for the first time, etc., or change the car battery.

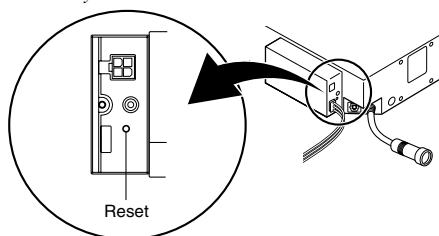

- For details, refer to "Initial System Start-Up" (page 9).

Mounting the Remote Control Sensor Unit

- When using a monitor with a built-in remote control sensor, such as the IVA-D105R, the external sensor is not used.
- When mounting the unit with double-sided adhesive tape, make sure the mounting surface is dry and free from dirt or grease.

- 1 Press the double-sided adhesive tape onto the back of the remote control sensor unit.**

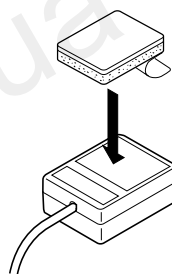

- 2 Before completing the sensor mounting, make sure the location selected is within the operating range of the remote control. Peel off the backing of the adhesive tape and press the sensor onto the selected mounting location.**

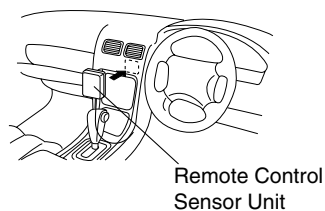

Installation

CAUTION

Be careful that the vehicle's cords do not touch the DHA-S690.

If the cords are in contact with the DHA-S690, their sheaths may be damaged due to vibrations generated while the vehicle is running, resulting in short-circuits. Leave enough space when routing wires to prevent contact between the vehicle's wires and the DHA-S690.

To prevent external noise from entering the audio system.

- Locate the unit and route the leads at least 10 cm away from the car harness.
- Keep the battery power leads as far away from other leads as possible.
- Connect the ground lead securely to a bare metal spot (remove any paint, dirt or grease if necessary) of the car chassis.
- If you add an optional noise suppressor, connect it as far away from the unit as possible. Your Alpine dealer carries various noise suppressors. Contact them for further information.
- Your Alpine dealer knows best about noise prevention measures so consult your dealer for further information.

1 Remove the shipping keys.

Three keys are mounted to the DHA-S690's bottom panel to protect the product during transportation. Be sure to remove these keys before installing the DHA-S690. So as not to lose the keys, store them in the special plastic pouch provided with the DHA-S690 and cover the key holes with the included dust-prevention seals.

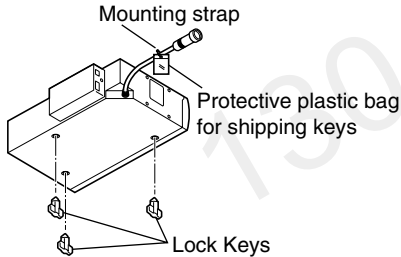

- The eject operation cannot be performed if the keys are mounted when the power is turned on. Turn the power off, then remove the keys.

2 Install the L-shaped bracket.

- 1 Determine the position and angle of installation.
- 2 Referring to step 3, change the position of the springs according to the angle of installation.
- 3 Install the L-shaped bracket ② according to the angle of installation. Fasten it in place using the double washer screws (M4x8) ⑥.

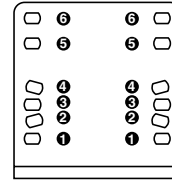

L-shaped bracket holes

Example of Installation Using Attached L-shaped bracket.

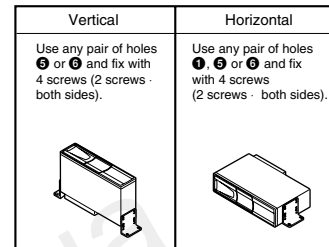

3 Change the position of the springs.

With this product, the positions of the built-in anti-vibration springs must be changed according to the angle of installation. The product will not provide the regular resistance to vibration if the anti-vibration springs are not in the correct positions or if the left and right springs are in different positions.

The anti-vibration springs can be placed at one of five angles.

The springs are set to the "H" angle upon shipment from the factory. To change this angle, follow the instructions given below.

- 1 Remove the covers provided at both left and right sides of the unit by pressing claws of the covers in the direction shown by the arrow.

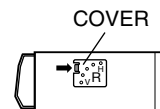

- 2 Change the position of the springs using a finger.
- 3 Mount the covers at the left and right sides as they were attached originally.

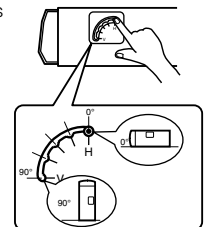

- Install the unit only at a horizontal or vertical angle. If the unit is diagonally installed, malfunction may result.

• Floor base installation

- 1 Determine the position under the carpet at which the unit is to be installed.
- 2 Insert the hexagonal bolts (M6x25) ⑤ into the floor base ③, then mount directly on the floor using the hexagonal washer faced tapping screws (M5x15) ①.

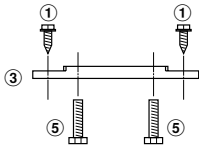

- 3 Make X-shaped cuts in the carpet.

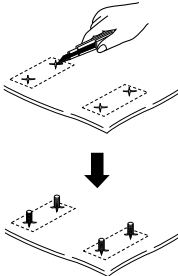

- 4 Install on top of the carpet using the shouldered hexagonal washer faced nuts (M6) ④.

Horizontal installation

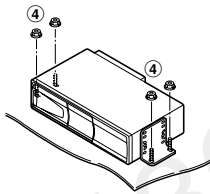

- When installing horizontally, make sure that the disc magazine's slot is on the left side.

Vertical installation

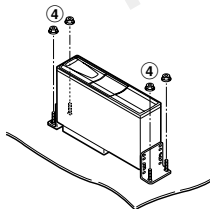

- When installing vertically, make sure that the disc magazine's slot is on the top side.

• Installing directly on the floor

⚠ WARNING
Do not damage pipe or wiring when drilling holes.

- 1 To install horizontally, attach to the floor using the hexagonal washer faced tapping screws (M5x15) ①.

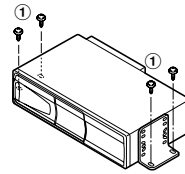

- 2 To install vertically, attach to the floor using the hexagonal washer faced tapping screws (M5x15) ①.

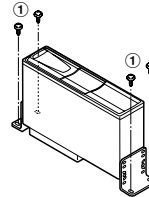

• Suspension from the Rear Tray

⚠ WARNING
Do not damage pipe or wiring when drilling holes.

- 1 Fasten the L-shaped brackets ② to both sides of this unit.

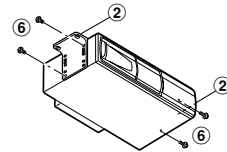

- 2 Drill holes about 6mm in diameter and fasten securely with shouldered hexagonal bolts (M6x50) ⑦ and shouldered hexagonal nuts (M6) ④.

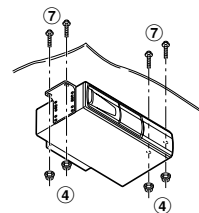

Checking Operation

- 1 Turn the ignition key on and check that the unit is operating properly, referring to the operating instructions.
- 2 Check that the vehicle's equipment (horn, stop lights, etc.) are operating properly.

Connections

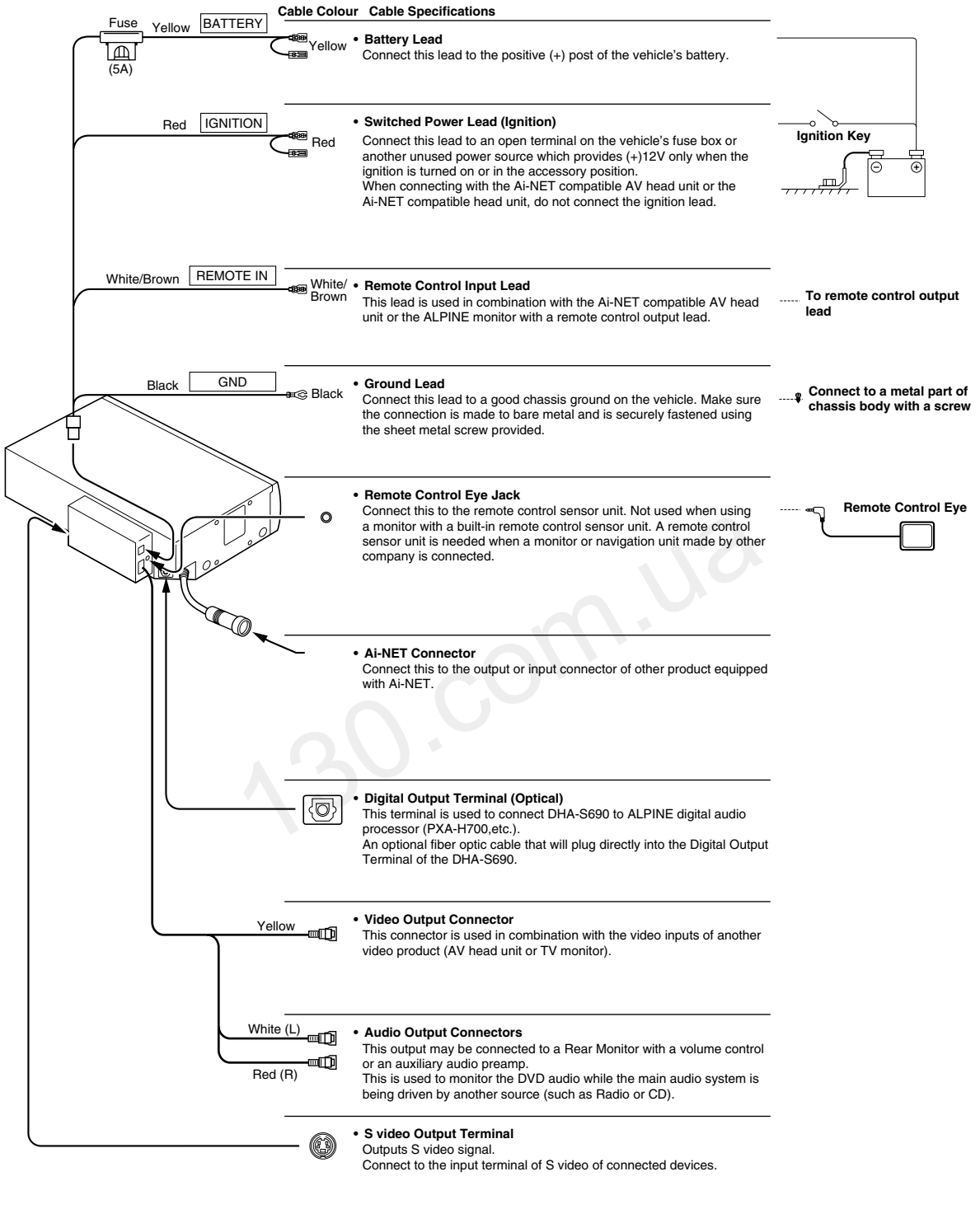

- Connect properly. Never connect to parts other than the ones indicated in these operating instructions.
- Also refer to the operating instructions of the other products in the system.

Setting the System Switch

Switch to operate from either an Ai-NET compatible head unit or Ai-NET compatible AV head unit connected to this unit. Be sure to set the system switch before fastening the DHA-S690 in place.

1 Disconnect the power plug.

2 Change the System Switch (Fig. 1).

This switch is used to select Ai-NET or Stand Alone operation. Change the switch position using a small screwdriver or other pointed object.

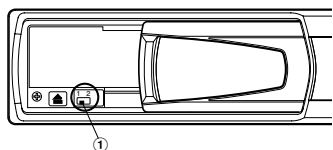

Fig. 1

① Ai-NET system Stand Alone system



1:

When connecting to an Ai-NET compatible head unit or Ai-NET compatible AV head unit.

If set to 2, with any of the Ai-NET compatible (AV) head units connected, you may not be able to operate from the head unit, or listen to audio from some external devices, etc.

The factory default is 1.

2:

When connecting to an Ai-NET incompatible head unit or another manufacturer's head unit.

CAUTION:

When switching the System Switch, make sure there are no cables attached to the DHA-S690.

3 Connect the power plug.

System Example

• Connecting a Monitor

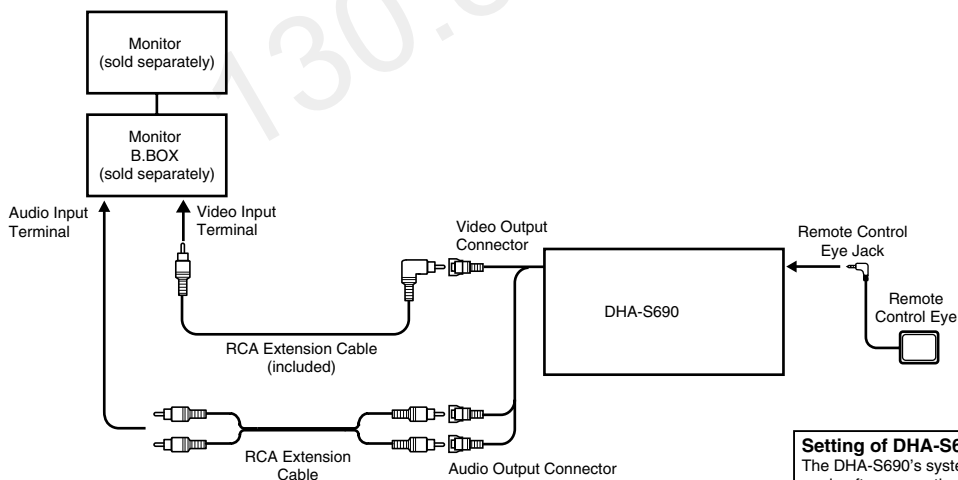

Setting of DHA-S690

The DHA-S690's system settings must be made after connections are completed. Before fixing the unit in place, refer to page 41 to change the system setting.

System Switch



Switches to "2".

- Be sure to connect the switched Power Lead (Ignition).
- Also refer to the operating instructions of the other products in the system.

● Connecting an Alpine front monitor/a rear monitor other than Alpine / Vehiclehub Pro (VPA-B222R)

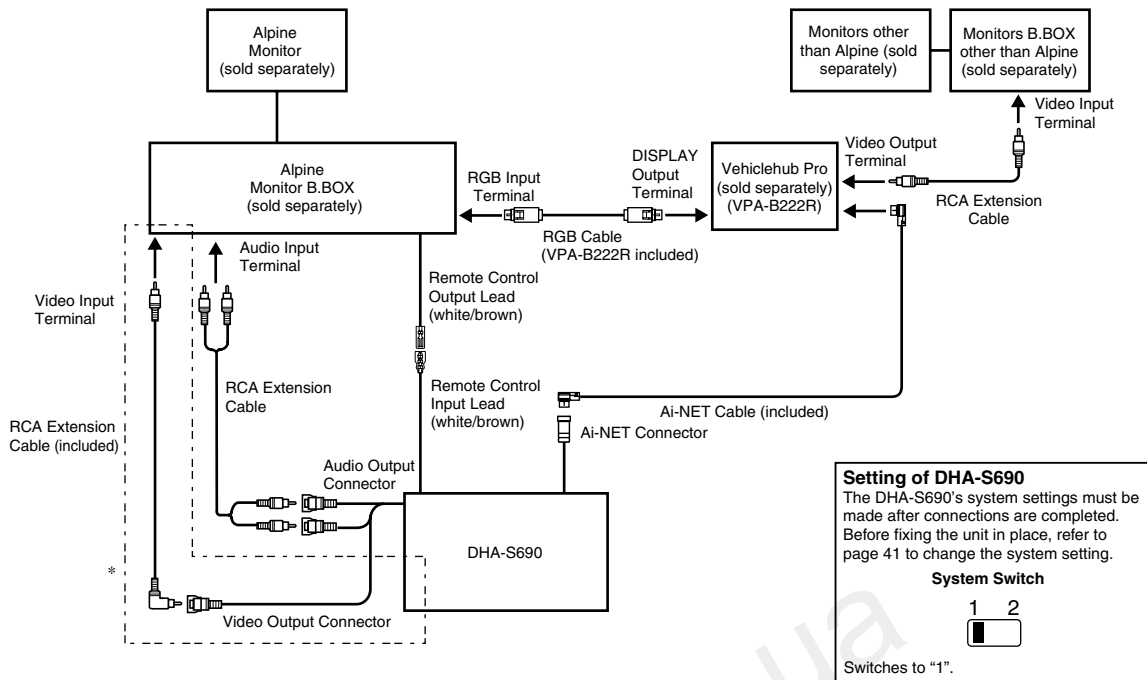

* When connecting an S terminal compatible monitor, connect to the S video terminal using the optional S terminal cable to output a video. At this time, disconnect the RCA Video.

- Also refer to the operating instructions of the other products in the system.

● Connecting an Ai-NET compatible Head Unit / Alpine Monitor

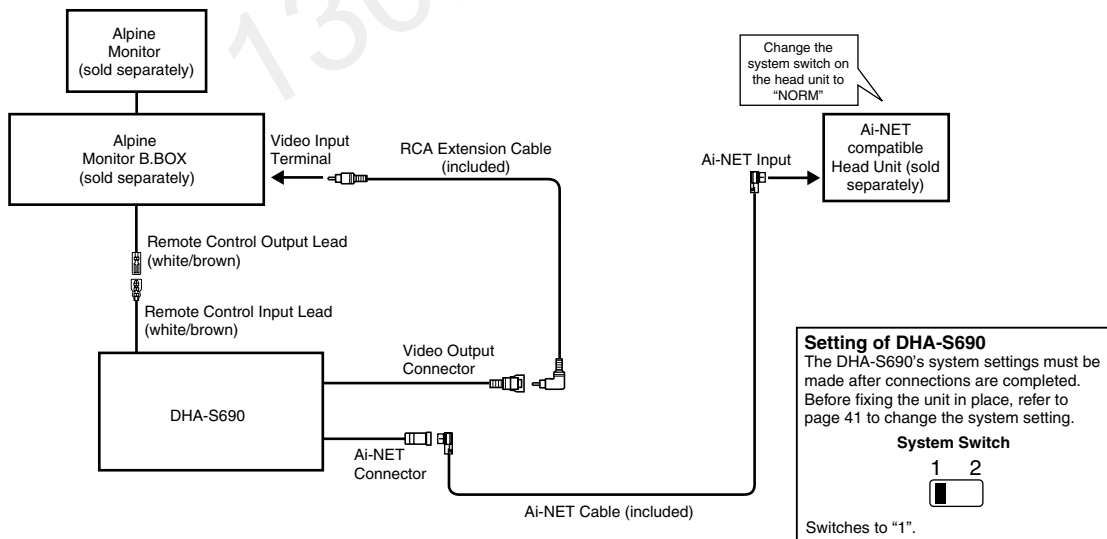

- Be sure to switch the head unit's system switch before turning the power on.
- Be sure to make the setting (DVD CHG or CD CHG) in "Setting the Connected Head Unit" (page 21) according to the connected Ai-NET compatible head unit.
- Also refer to the operating instructions of the other products in the system.
- When connecting another brand of TV monitor, there is no need to connect the remote control input cord (white/brown). Use the remote control sensor unit included with the DHA-S690.

● Connecting an Ai-NET compatible AV head unit / Digital Audio Processor

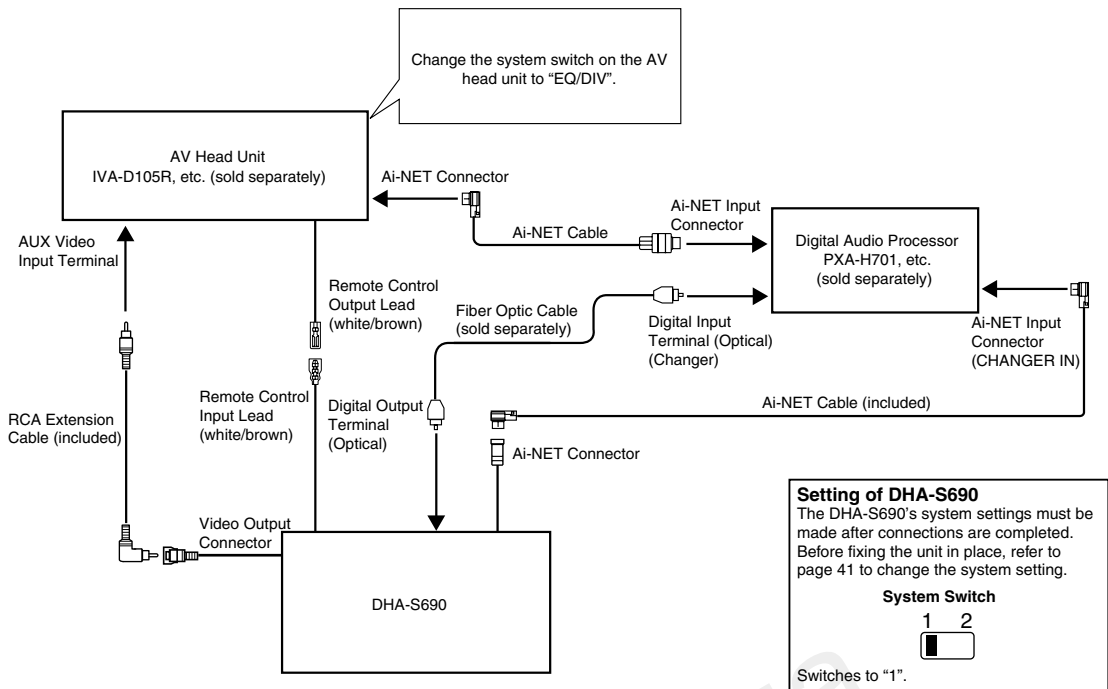

- Be sure to switch the head unit's system switch before turning the power on.
- Be sure to make the setting (DVD CHG or CD CHG) in "Setting the Connected Head Unit" (page 21) according to the connected Ai-NET compatible head unit.
- If CD CHG is set in "Setting the Connected Head Unit" (page 21):
If you want to play back a DVD Audio, set "Switching the input (non Ai-NET connections)" on the connected Alpine audio processor (PXA-H700, PXA-H701) to "Analog." For details on operation, refer to the Owner's Manual of the audio processor.
- The switched Power Lead (Ignition) connection is not needed.
- Also refer to the operating instructions of the other products in the system.
- When connecting the optical digital output to a digital audio processor, be sure to make connection to the CHANGER connectors of the digital audio processor optical digital input connectors. This arrangement allows you to enjoy Dolby Digital 5.1 Channel Surround and other effects even when connection is made to the CHANGER connectors.

Observe the following when using Fiber Optic Cable.

- Be careful not to bend the fiber optic cable at a sharp angle.
- Do not coil the fiber optic cable smaller than a 30 mm radius.
- Do not place anything on top of the fiber optic cable.

130.com.ua