



PHONES

(044) 360-7-130
 (050) 336-0-130
 (063) 788-0-130
 (067) 233-0-130
 (068) 282-0-130

130 Internet store of autogoods

COM.UA



ICQ
 294-0-130
 597-0-130

SKYPE
 km-130

CAR RECEIVERS — Receivers • Media receivers and stations • Native receivers • CD/DVD changers • FM-modulators/USB adapters • Flash memory • Facia plates and adapters • Antennas • Accessories |
 CAR AUDIO — Car audio speakers • Amplifiers • Subwoofers • Processors • Crossovers • Headphones • Accessories | TRIP COMPUTERS — Universal computers • Model computers • Accessories |
 GPS NAVIGATORS — Portable GPS • Built-in GPS • GPS modules • GPS trackers • Antennas for GPS navigators • Accessories | VIDEO — DVR • TV sets and monitors • Car TV tuners • Cameras • Videomodules
 • Transcoders • Car TV antennas • Accessories | SECURITY SYSTEMS — Car alarms • Bike alarms • Mechanical blockers • Immobilizers • Sensors • Accessories | OPTIC AND LIGHT — Xenon • Bixenon • Lamps
 • LED • Stroboscopes • Optic and Headlights • Washers • Light, rain sensors • Accessories | PARKTRONICS AND MIRRORS — Rear parktronic • Front parktronic • Combined parktronic • Rear-view mirrors
 • Accessories | HEATING AND COOLING — Seat heaters • Mirrors heaters • Screen-wipers heaters • Engine heaters • Auto-refrigerators • Air conditioning units • Accessories | TUNING — Vibro-isolation
 • Noise-isolation • Tint films • Accessories | ACCESSORIES — Radar-detectors • Handsfree, Bluetooth • Windowlifters • Compressors • Beeps, loudspeakers • Measuring instruments • Cleaners • Carsits
 • Miscellaneous | MOUNTING — Installation kits • Upholstery • Grilles • Tubes • Cable and wire • Tools • Miscellaneous | POWER — Batteries • Converters • Start-charging equipment • Capacitors
 • Accessories | MARINE AUDIO AND ELECTRONICS — Marine receivers • Marine audio speakers • Marine subwoofers • Marine amplifiers • Accessories | CAR CARE PRODUCTS — Additives • Washer fluid •
 Care accessories • Car polish • Flavors • Adhesives and sealants | LIQUID AND OIL — Motor oil • Transmission oil • Brake fluid • Antifreeze • Technical lubricant



In store "130" you can find and buy almost all necessary goods for your auto in Kyiv and other cities, delivery by ground and postal services. Our experienced consultants will provide you with exhaustive information and help you to chose the very particular thing. We are waiting for you at the address

<http://130.com.ua>

KENWOOD

KSC-SW10

POWERED ENCLOSED SUBWOOFER

INSTRUCTION MANUAL

CAISSON D'EXTRÊME GRAVE AMPLIFIÉ

MODE D'EMPLOI

GEKAPSELTER SUBWOOFER MIT VERSTÄRKER

BEDIENUNGSANLEITUNG

SUBWOOFER MET SPANNINGSCIRCUIT

GEBRUIKSAANWIJZING

SUBWOOFER CON AMPLIFICATORE E CASSA

ISTRUZIONI PER L'USO

ALTAVOZ DE SUBGRAVES CON CERRADO ALIMENTACION

MANUAL DE INSTRUCCIONES

УСИЛЕННЫЙ ЗАКРЫТЫЙ САБВУФЕР

ИНСТРУКЦИЯ ПО ЭКСПЛУАТАЦИИ



AE86

Kenwood Corporation

© B61-1319-00/00 (W) KW

IMPORTANT SAFETY INSTRUCTIONS

⚠ Caution: Read this page carefully to ensure safe operation.

⚠ WARNING

- Before mounting or wiring etc., be sure to remove the wire from the battery minus terminal.
(Not doing so can cause shorts or fires.)
- When extending the ignition, battery, or ground wires, make sure to use automotive-grade wires or other wires with a 0.75mm² (AWG18) or more to prevent wire deterioration and damage to the wire coating.
- To prevent a short circuit, never put or leave any metallic objects (such as coins or metal tools) inside the speaker.
- In the event the unit generates smoke or abnormal smell, immediately switch the power OFF. After this, please contact your dealer or nearest service station as soon as possible.

POWER OFF!

- Connect the illumination lamp-equipped speakers to DC 12V, negative ground.
- Do not attempt to open or modify the unit, for this could cause fire hazard or malfunction.
- After taking the unit out of the polyethylene bag, be sure to dispose of the polyethylene bag out of the reach of children. Otherwise, they may play with the bag, which could cause hazard of suffocation.

⚠ CAUTION

- Installation and wiring of the product requires expert skill and experience. To ensure safety, be sure to have your dealer or specialist perform the installation and wiring.
- Do not install the speaker in a spot exposed to direct sunlight or excessive heat or humidity.
- Do not install the speakers in locations which may be subject to water or moisture.
- Do not install the speakers in unstable locations or locations subject to dust.
- If the fuse blows, after checking to see if the wiring cord has shorted, be sure to replace with the stipulated size (ampere) fuse as displayed on the fuse box.
(Using fuses other than the stipulated size can cause fires.)

Check the display!

To replace the fuse, refer to the vehicle instruction manual.

- To prevent a short circuit when replacing a fuse, disconnect the wiring harness at first.
- Do not use gasoline, naphtha, or any type of solvent to clean the speaker. Clean by wiping with a soft, dry cloth.
- Connect the speaker wires to appropriate speaker connectors separately. Sharing the negative wire of the speaker or grounding speaker wires to the metal body of the car can cause this unit to fail.
- Do not connect cables and leads to both RCA cord input jacks and the speaker input terminals simultaneously, for this may cause malfunction or damage.
- When making a hole under a seat, inside the trunk, or somewhere else in the vehicle, check that there is nothing hazardous on the opposite side such as a gasoline tank, brake pipe; or wiring harness, and be careful not to cause scratches or other damage.
- For ground wire mounting, do not fasten the wire to an airbag, steering or brake line system or other critical safety unit bolts or nut.
(Can cause accidents.)
- When mounting, be sure to mount in a place that will not interfere with driving or be dangerous to passengers during sudden braking etc.
(Cause of injury or accidents.)
- After installing the unit, check to make sure that electrical equipment such as the brake lamps, turn signal lamps and windshield wipers operate normally.

Information on Disposal of Old Electrical and Electronic Equipment (applicable for EU countries that have adopted separate waste collection systems)



Products with the symbol (crossed-out wheeled bin) cannot be disposed as household waste.

Old electrical and electronic equipment should be recycled at a facility capable of handling these items and their waste by products.

Contact your local authority for details in locating a recycle facility nearest to you.

Proper recycling and waste disposal will help conserve resources whilst preventing detrimental effects on our health and the environment.



Declaration of Conformity with regard to the EMC Directive 2004/108/EC

Manufacturer:

Kenwood Corporation
2967-3 Ishikawa-machi, Hachioji-shi, Tokyo,
192-8525 Japan

EU Representative's:

Kenwood Electronics Europe BV
Amsterdamseweg 37, 1422 AC UITHOORN,
The Netherlands





For your records

Record the serial number, found on the back of the amplifier, in the spaces designated on the warranty card, and in the space provided below. Refer to the model and serial numbers whenever you call upon your dealer for information or service on this product.

Model : KSC-SW10

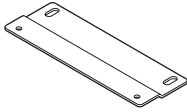
Serial Number : _____

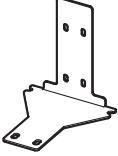
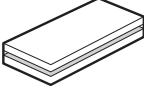
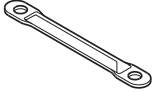
Parts included

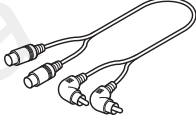
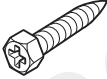
No.	Part Name	Outside Shape	Quantity	No.	Part Name	Outside Shape	Quantity
①	Fixture A		2	⑥	10-pin connector cord (6 m / 19 ft)		1
②	Fixture B		2	⑦	Velcro tape (Double-side adhesive/ for Remote control)		1
③	Fixture C		1	⑧	Remote control (6 m / 19 ft)		1
④	Machine screw (M4 x 6)		8	⑨	RCA cord (0.5 m / 1.6 ft)		1
⑤	Tapping screw (ø 5 x 16)		6				

Connection

⚠ Caution:

Before wiring, be sure to remove the wire from the negative terminal of the battery. After completing all wiring, check the correct wirings again. After checking, connect the wire from the negative terminal of the battery.

Terminals of Subwoofer

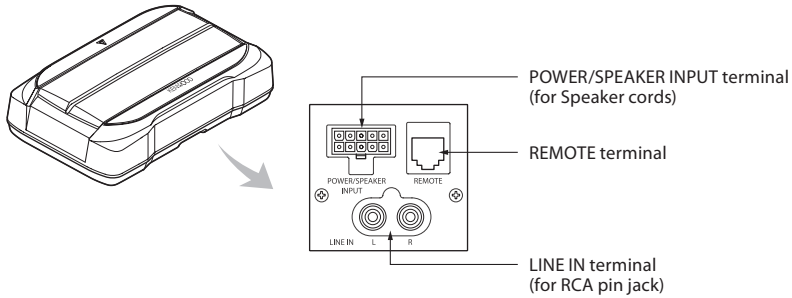

Connecting the remote control unit

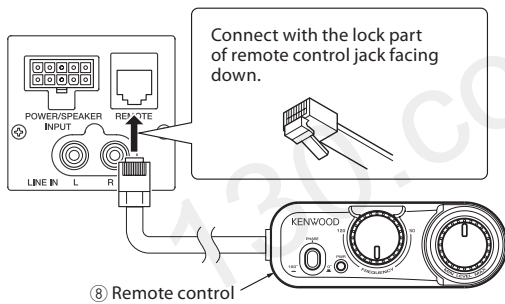

Notes:

- If the cord is not connected properly, the power indicator on the remote control unit and the illumination on the main unit do not light up.
- If the remote control unit is not connected properly or at all, the subwoofer does not output the sound.
- Do not insert the remote control connector upside down or forcibly. Otherwise, malfunction may result.

Connecting the subwoofer to the speaker output of the center unit with built-in amplifier

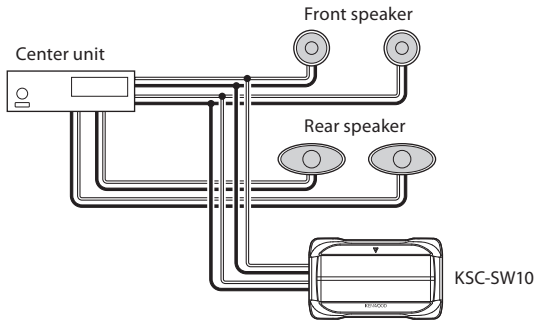

Connect the subwoofer to the front or rear output cords of the center unit.

Note:
Read the instruction manuals for the connected components such as the center unit as well as this instruction manual.

ENGLISH

Examples

The following shows a typical connection for effective car stereo enjoyment. Connect your system by referring to the example.

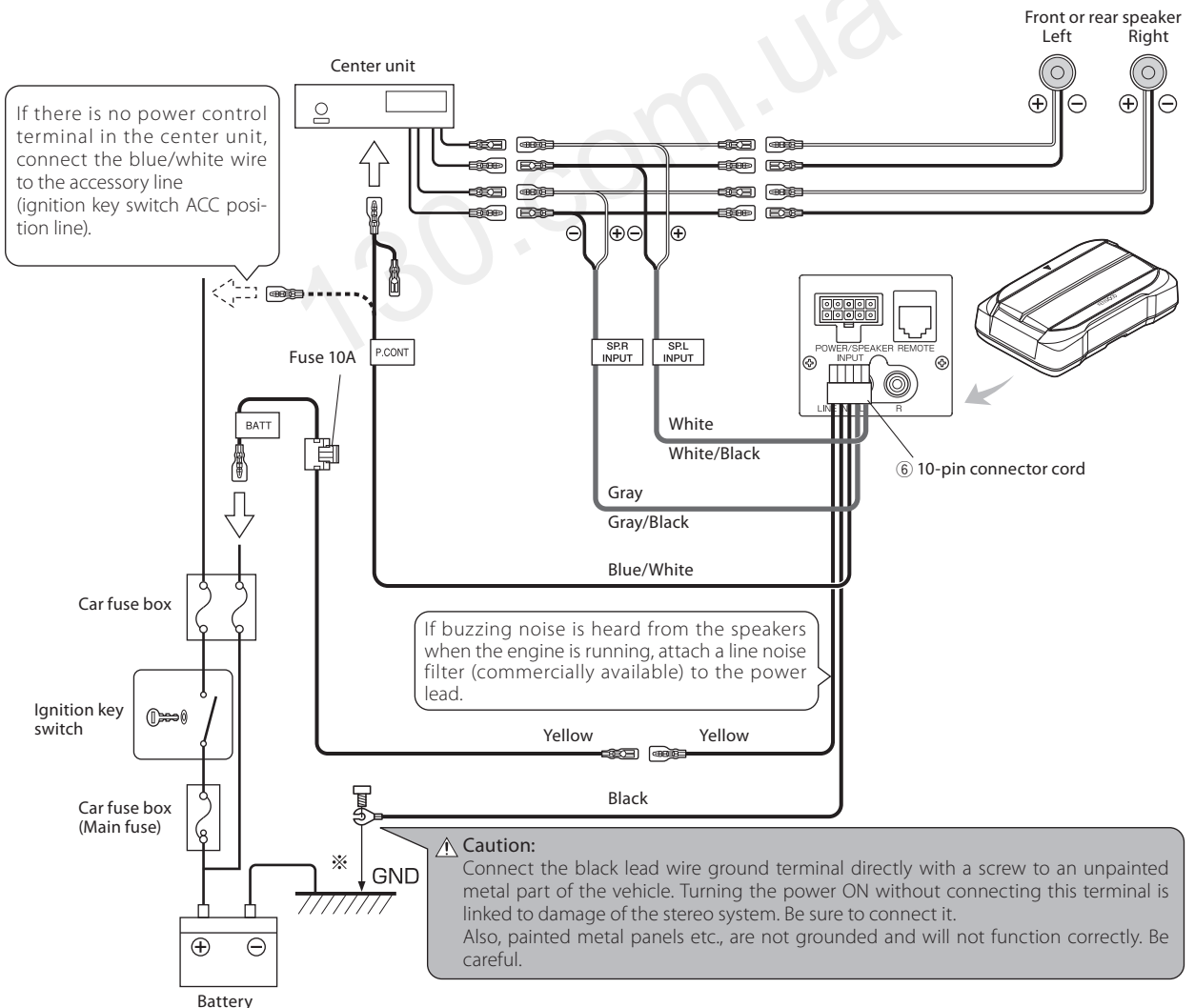

Connecting the subwoofer to the subwoofer (non-fader) output of the center unit

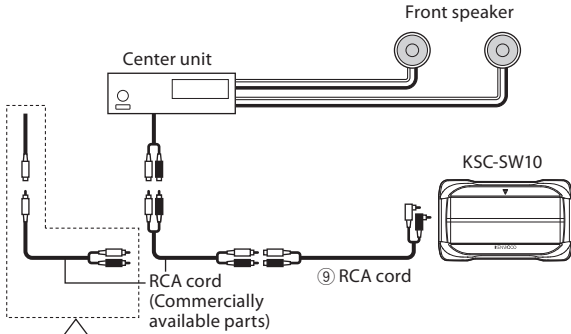

When the center unit output is a single RCA jack, use an RCA cord that converts the output into the two RCA jacks as shown above. The subwoofer output will be halved if the conversion cord is not used.

Connect the subwoofer to the subwoofer output (non-fader output) or the RCA jacks for the front output of the center unit.

Notes:

- Read the instruction manuals for the connected components such as the center unit as well as this instruction manual.
- Please purchase an RCA cord that is commercially available separately. Use the provided RCA cord ⑨ for connection between the subwoofer and the separately purchased RCA cord.
- When the center unit incorporates a DSP, connect the subwoofer to the subwoofer output (non-fader output) or to the RCA jacks for the front output. Do not connect to the RCA jacks for the rear output, as the low-frequency reproduction effect may be attenuated due to the DSP effect.

Examples

The following shows a typical connection for effective car stereo enjoyment. Connect your system by referring to the example.

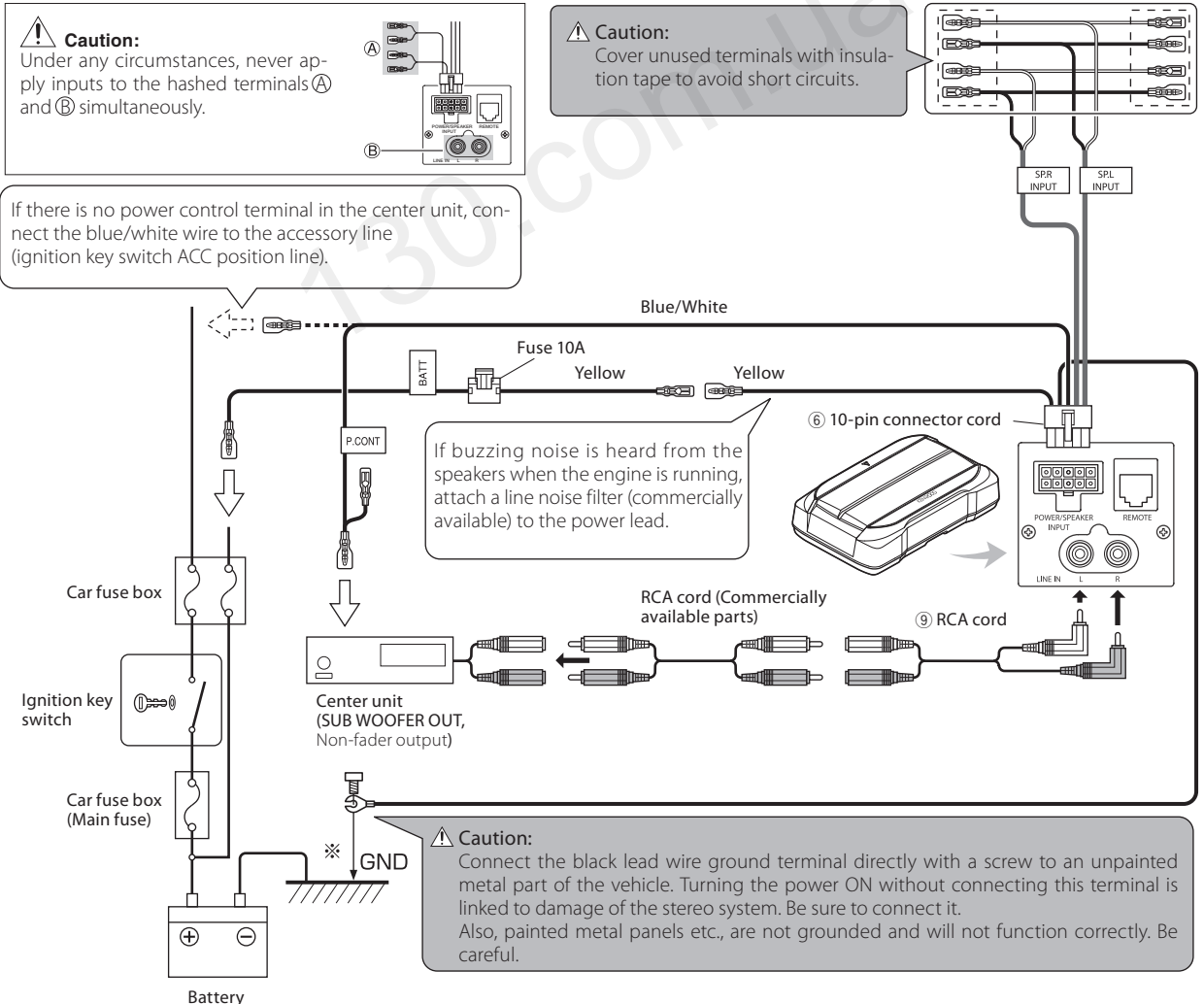

Installation

Before fixing the speaker in its position, be sure to check the sound while it is connected preliminary.

⚠ Caution:

- Install in a location that does not come in the way of driving, getting in or out of the vehicle and movement inside the vehicle compartment.
- Fix the product firmly so that it will not be moved by vibrations or impacts during driving.

Fixing the cord in place

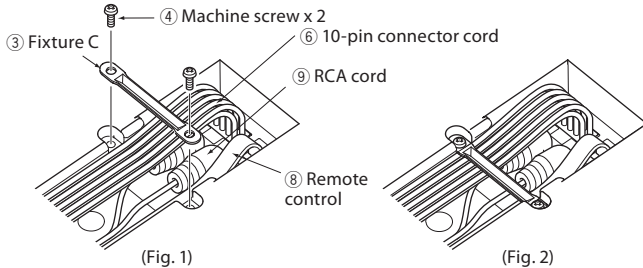

- 1 Connect the 10-pin connector cord ⑥, RCA cord ⑨, and remote control ⑧ to the speaker unit. (Fig. 1) (When connecting the speaker input terminal, RCA cord is not necessary.) (The cords to be connected depends on the system. Refer to Connection of example.)
- 2 Fix the cords to the speaker unit with fixture C ③, and fix in place with the machine screws ④. (Fig. 2)

Fixing the subwoofer

Flat installation

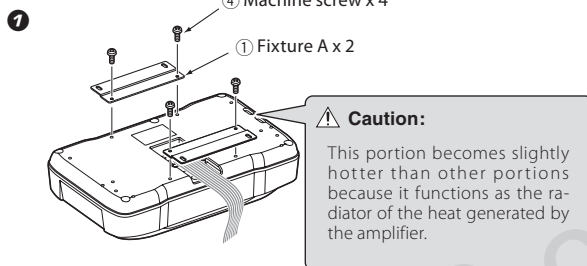

Attach the fixtures A ① to the speaker unit securely using the machine screws ④. Be careful so that the connected cords do not get in between the speaker unit and fixtures A ①.

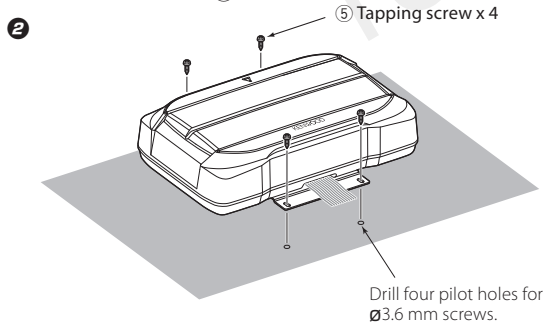

Drill the pilot holes for $\varnothing 3.6$ mm screws on the sheet metal section of the vehicle, and attach the speaker unit to the vehicle using the tapping screws ⑤.

Side installation

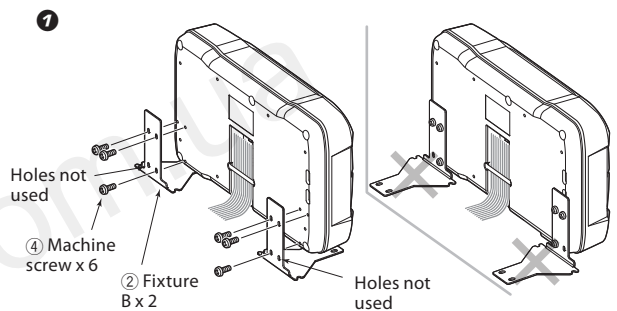

Adjust the installation height so that the speaker unit will not rattle, and attach the bracket B ② to the subwoofer using the machine screws ④.

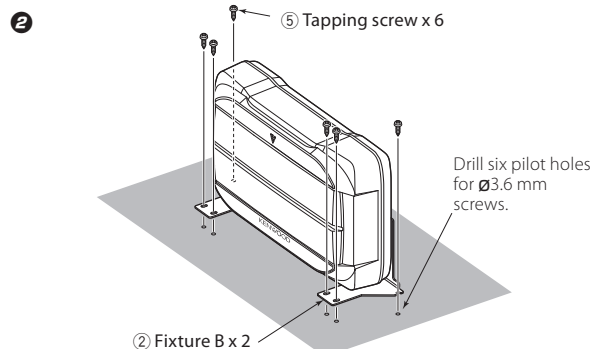

Drill the pilot holes for $\varnothing 3.6$ mm screws on the sheet metal section of the vehicle, and attach the speaker unit to the vehicle using the tapping screws ⑤.

Installing the remote control unit

Install the remote control unit on the vehicle by the provided Velcro tape.

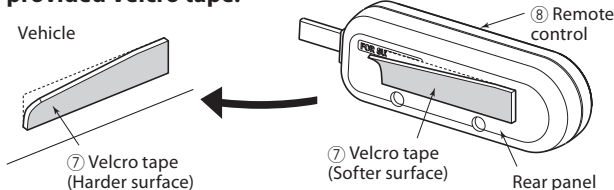

⚠ Caution:

Install the remote control unit in a position that does not come in the way of driving operations. Avoid installing it in a place subject to direct sunlight or direct hot wind from the heater. Otherwise, the product may be degraded and a fire hazard may result. Remove dirt from the installation position before attaching the Velcro tape. When the Velcro tape is attached on the remote control unit, it cannot be accommodated in the main unit.

Operation

Name of each part (Remote control)

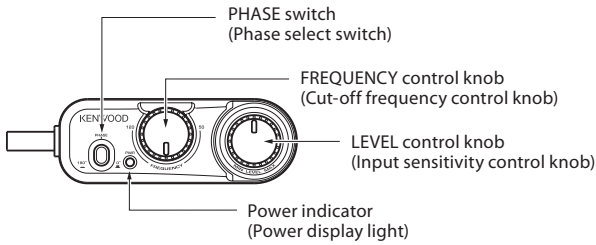

The illumination on the subwoofer turns on and off in an interlocked operation with the PWR indicator on the remote control unit.

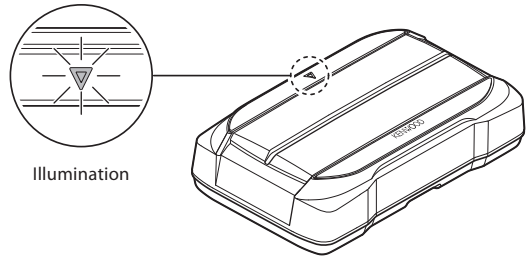

Power indicator

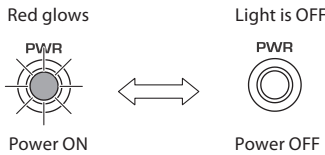

Adjusting the sound (Remote control operation)

- 1 Turn the FREQUENCY control knob to adjust the cut-off frequency (frequencies higher than this frequency are cut off).

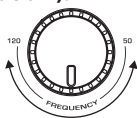

Turn the FREQUENCY control knob to adjust the balance between the bass from the rear speakers and the bass from this unit as desired.

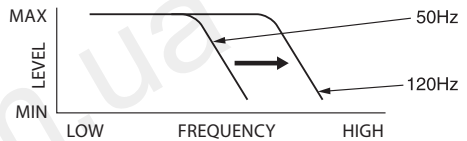

- 2 Turn the LEVEL control knob to adjust the low frequencies to the desired level.



- 3 Adjust the low frequency phase.

The low frequency tone may be variable depending on the position of the unit, its orientation or the turn-over frequency. This can be adjusted by changing the position of the PHASE switch. Set this switch to either position according to your liking. [[0°] indicates the normal phase and [180°] means the reverse phase.

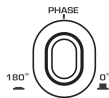

Fuse exchange

Exchange with the specified capacity fuse.



Caution: Be sure to replace with same capacity (amperage) as displayed on the fuse. This product is 10A.

Removal

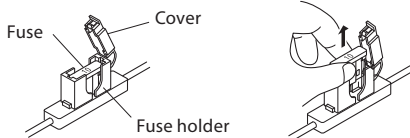

- 1 Open the cover.
- 2 Grasp with pliers and pull up.

Insertion

Replacement fuse 10 A

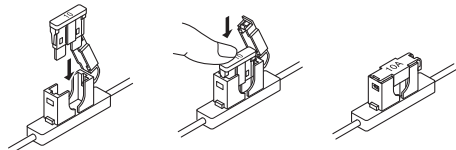

- 1 Insert the fuse gently into the fuse holder and push in all the way with your finger.
- 2 Close the cover.

Troubleshooting guide

Often, what appears to be a malfunction is due to user error. Before calling for service, please consult the following table.

Problem	Cause	Remedy
Power cannot be turned on (the POWER indicator does not light).	• The fuse is blown.	• Check the (+)/(-) polarity of the power cord and that the cords are not shorted, then replace with a fuse with the rated capacity. • Re-connect the cords correctly by referring to the connection example (on page 5, 6).
	• The remote control cord is unplugged.	• Plug the cord into the REMOTE terminal.
	• The power supply pin (yellow) of the 10-pin connection cord is not connected.	• Connect the cord correctly by referring to the connection example (on page 5, 6).
	• The power control pin (blue/white) of the 10-pin connection cord is not connected.	• Check the connections of all cords, then connect the (-) cable to the battery.
	• The 10-pin connector is not plugged in completely.	• Insert the connector all the way in.
	• The grounding pin (black) of the 10-pin connection cord is not connected.	• Attach the grounding terminal to the metallic section of the vehicle (not a coated surface) by tightly screwing it.
	• The negative (-) cable of the car battery is disconnected.	• Check the connections of all cords, then connect the (-) cable to the battery.
No sound	• The attenuator of the center unit is set to ON.	• Switch the attenuator OFF.
	• The LEVEL control is set to the MIN position.	• Increase the volume to an optimum level (on page 8).
	• The speaker cords are connected improperly.	• Connect the cords correctly by referring to the connection example (on page 5, 6).
	• Connection terminals are connected improperly.	• Insert the connectors or jacks all the way in to the terminals.
	• The remote control cord is unplugged.	• Plug the cord into the REMOTE terminal.
Sound is small.	• The input level is set to low.	• Turn the LEVEL control knob and set the input level to an optimum level.
Sound quality is bad (sound is distorted).	• The input level is set to high.	
Sound is unnatural.	• The speaker cords are connected with incorrect positive (+)/negative (-) polarity.	• Connect the cords correctly by referring to the connection example (on page 5, 6).
	• The grounding pin (black) of the 10-pin connection cord is poorly contacted.	• Attach the grounding terminal to the metallic section of the vehicle (not a coated surface) by tightly screwing it.
	• The balance between the front speakers or between those and the rear speakers are not well adjusted.	• Adjust the tone balance by switching the PHASE switch to 0° or 180° as required (on page 8).

ENGLISH

Specifications

The following ratings and design are subject to change without notice.

Type **Powered Enclosed Subwoofer**

[Amp unit]

Maximum output **150 W**

Frequency response **35 - 120 Hz**

S/N ratio **85 dB**

Cut-off frequency **50 - 120 Hz**

Phase **0°, 180°**

Input sensitivity/impedance

RCA pin jack **50 mV / 15 kΩ**

Speaker input **1.0 V / 2.2 kΩ**

Power **DC 14.4 V (Operating range 10.5 - 16 V)**

Maximum current consumption **8 A**

Fuse capacity **10 A**

[Speaker unit]

Enclosure **Passive radiator type**

Active woofer **120 x 180 mm (4-3/4" x 7-1/16") (cone)**

Passive woofer **120 x 180 mm (4-3/4" x 7-1/16") (cone)**

External size **Width: 369 mm (14-1/2")**

Height: 94 mm (3-11/16")

Depth: 224 mm (8-13/16")

Weight (net) **3.4 kg (7.5 lb)**