



PHONES

(044) 360-7-130  
(050) 336-0-130  
(063) 788-0-130  
(067) 233-0-130  
(068) 282-0-130

# 130 Internet store of autogoods

COM.UA



ICQ  
294-0-130  
597-0-130

SKYPE  
km-130

CAR RECEIVERS — Receivers • Media receivers and stations • Native receivers • CD/DVD changers • FM-modulators/USB adapters • Flash memory • Facia plates and adapters • Antennas • Accessories | CAR AUDIO — Car audio speakers • Amplifiers • Subwoofers • Processors • Crossovers • Headphones • Accessories | TRIP COMPUTERS — Universal computers • Model computers • Accessories | GPS NAVIGATORS — Portable GPS • Built-in GPS • GPS modules • GPS trackers • Antennas for GPS navigators • Accessories | VIDEO — DVR • TV sets and monitors • Car TV tuners • Cameras • Videomodules • Transcoders • Car TV antennas • Accessories | SECURITY SYSTEMS — Car alarms • Bike alarms • Mechanical blockers • Immobilizers • Sensors • Accessories | OPTIC AND LIGHT — Xenon • Bixenon • Lamps • LED • Stroboscopes • Optic and Headlights • Washers • Light, rain sensors • Accessories | PARKTRONICS AND MIRRORS — Rear parktronic • Front parktronic • Combined parktronic • Rear-view mirrors • Accessories | HEATING AND COOLING — Seat heaters • Mirrors heaters • Screen-wipers heaters • Engine heaters • Auto-refrigerators • Air conditioning units • Accessories | TUNING — Vibro-isolation • Noise-isolation • Tint films • Accessories | ACCESSORIES — Radar-detectors • Handsfree, Bluetooth • Windowlifters • Compressors • Beeps, loudspeakers • Measuring instruments • Cleaners • Carsits • Miscellaneous | MOUNTING — Installation kits • Upholstery • Grilles • Tubes • Cable and wire • Tools • Miscellaneous | POWER — Batteries • Converters • Start-charging equipment • Capacitors • Accessories | MARINE AUDIO AND ELECTRONICS — Marine receivers • Marine audio speakers • Marine subwoofers • Marine amplifiers • Accessories | CAR CARE PRODUCTS — Additives • Washer fluid • Care accessories • Car polish • Flavors • Adhesives and sealants | LIQUID AND OIL — Motor oil • Transmission oil • Brake fluid • Antifreeze • Technical lubricant



In store "130" you can find and buy almost all necessary goods for your auto in Kyiv and other cities, delivery by ground and postal services. Our experienced consultants will provide you with exhaustive information and help you to chose the very particular thing. We are waiting for you at the address

<http://130.com.ua>



## How to install and operate the X-program amplifiers

X-A10  
X-A20  
X-A30  
X-A40



### Welcome!

This owners manual is written in easy english and uses a lot of drawings to simply the installation and use of the above amplifiers.

Your X-program amplifiers must be installed correctly in order to work well. This manual will show you how to install the amplifier like a pro. Please read the entire manual before beginning the installation. Install the amplifier yourself if you feel confident with our instructions and if you have the proper tools. However if you feel unsure, turn over the installation job to someone better suited to it.

### Warranty Service

This amplifier is covered by warranty, depending on the conditions in the country where it is sold. If the amplifier is returned for service, please include the original dated receipt with the product.



### Technical Assistance

For technical assistance ask the shop where the product was sold or the distributor in your very country. Information can also be found on our WEB-site [www.xprogram.com](http://www.xprogram.com)

We follow a policy of continuous advancement in development. For this reason all or part of specifications & designs may be changed without prior notice.

### DECLARATION OF CONFORMITY

X-program amplifiers for vehicles are manufactured in accordance with the EU directive EEC 95/54 (72/245/EEC) and are marked with the approval number. They are also marked in accordance with the WEEE-directive 2002/96/EC.

The products are also produced in accordance with the EU RoHS directive 2002/95/EC.

## Contents

Features.....	2
Installation.....	2
Tools and materials needed.....	3
Amplifier installation kit.....	3
Routing Wires.....	3
<b>Wiring</b>	
Power and Outputs.....	4
Inputs and controls.....	5
High and low level inputs.....	5
Input level control.....	6
Crossovers, etc.....	6
Features on each model .....	6-7
<b>X-A10 speaker wiring:</b>	
Subwoofer.....	8
<b>X-A20 speaker wiring:</b>	
Front speakers.....	9
Subwoofer.....	9
<b>X-A30 speaker wiring:</b>	
Two speakers and subwoofer.....	10
<b>X-A40 speaker wiring:</b>	
Four speakers.....	11
Two speakers and bridged subwoofer	11
Testing.....	12
Troubleshooting.....	12
Professional tips.....	13
Specifications.....	14



This product must be returned to the separate collection system for electronic products. Do not dispose this product together with general household waste.

X-program is designed, engineered and distributed by:

**DLS Svenska AB**

P.O. Box 13029 - SE-40251 Göteborg - Sweden

Tel: +46 31 840060 - Fax: +46 31 844021

E-mail: [info@dls.se](mailto:info@dls.se)

[www.xprogram.com](http://www.xprogram.com)

X-program products are produced in Taiwan



The models include the following features:

- Analogue class AB technique
- High efficiency
- Low profile design
- RCA line inputs
- High level input with Auto start
- Powerful cable terminals
- Built-in active crossovers

# Installation

## Before you begin installation

Before you begin you need to read the manual, to have some tools, cables and other material available. There is one such list of material on the following page.

## Amplifier location

### Important

Allow air circulation around the amplifier.

The X-program series of amplifiers have a compact design that allows great flexibility in mounting. You can mount it under a seat or in the trunk. When you select a location, do remember that the amplifier generates a lot of heat.

Choose a location where air can circulate freely around the amplifier. Do not cover the amplifier with carpets or hide behind trim panels. Do not mount the amplifier in an inverted or upside down position.

X-A10 has a cooling fan built-in, make sure that the air can circulate freely around the fan opening.

Check all locations and placements carefully before making any cuts, drilling any holes or making any connections.

### **IMPORTANT!**

Use the metal screws and the plastic washer coming with the amplifier when you do the install. Do not use oversized screws, you may destroy the plastic ears by doing so.

## Disconnect Battery

Before starting the installation, always disconnect the negative terminal of the battery.

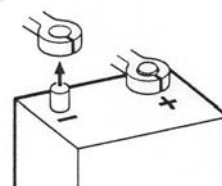

## X-logo on amplifier cooling flange

The X-logo on the amplifier top is attached with two small screws. The logo can be removed and twisted 90 or 180 degrees, and then screwed back in wanted position. The logo can be mounted in four different ways to match your installation.





## Tools and material needed

### Tools:

- ◆ Flat and Phillips screwdrivers
- ◆ Wire cutter
- ◆ Wire stripper
- ◆ Electric drill with drills
- ◆ Crimping tool
- ◆ Digital multimeter or test lamp
- ◆ Wire brush, scraper or a piece of an abrasive sheet to remove paint for a good ground connection
- ◆ Grease to protect the ground connection from oxidation

### Material:

- ◆ Speaker wire: minimum 12 AWG = 4 mm<sup>2</sup> for subwoofers 13 – 16 AWG = 1,5-2,5 mm<sup>2</sup> for other speakers
- ◆ Sheet metal screws for mounting the amplifier to the amplifier board and the amplifier board to the car + some extra for fuse holder, amplifier ground etc.
- ◆ Electrical insulation tape
- ◆ ½ inch thick plywood or particle board for the amplifier to be mounted upon.

### Amplifier installation kit:

If available, buy an amplifier installation kit. It contains normally all you need. This is what you have to buy if you buy the items separately

- ◆ 20- 25 feet = 6- 7.5 meter power cable, minimum AWG 8 = 10 mm<sup>2</sup> or heavier
- ◆ 1 pc of fuseholder to install close to the car battery + fuse 40 -50 Ampere.
- ◆ 20 feet of AWG 15 = 1,5 mm<sup>2</sup> wire for remote turn on / off cable from radio.
- ◆ RCA-cable for input from radio.
  - 20 feet or 5 meter for trunk installations
  - 12 feet or 2 – 3 meter for under seat installations
- ◆ Two ring crimp terminals (RT22) –one for connection to the battery plus and one for the amplifier ground connection.
- ◆ Two heavy fork crimp terminals (FT22) to connect + and – to amplifier – but you do only need them if you use heavy cable or to make the installation look nicer.
- ◆ Four to ten fork crimp terminals (FT10) to connect the speaker cables – but you do only need them if you use heavy cables or want the installation to look nicer.
- ◆ One fork crimp terminal to connect the remote wire to the amplifier, but you need it only to make it look nicer.
- ◆ Four to eight splicers to connect speaker cables to high level input cable, if high level input is used.
- ◆ Wire ties
- ◆ Insulating grommet or insulating tube

## Routing wires

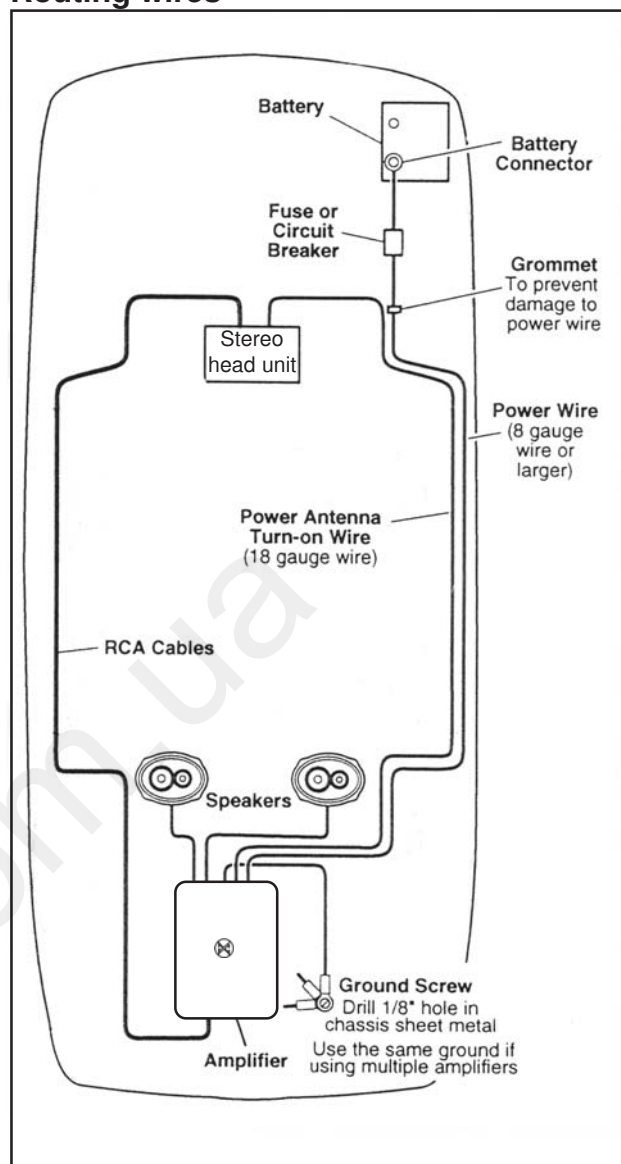

### Professional Tip:

If amplifier installation kits are available with different size of power cable, chose the most heavy power cable to improve sound quality and to allow more amplifiers to be installed now or later.

The amplifier power terminals accept AWG 4 cables using FT22 fork terminal, so If possible buy AWG 4 = 21 mm<sup>2</sup> cable for best performance. Both the positive wire and the ground wire must have the same size. To avoid cable fire, be sure not to oversize the main fuse value for the power wires.

### THE DC-FEED

Maximum main fuse values for different cable sizes.

6 mm <sup>2</sup> (9 AWG)	:25 A	10 mm <sup>2</sup> (7AWG)	:40 A
16 mm <sup>2</sup> (5AWG)	:60 A	21 mm <sup>2</sup> (4AWG)	:100 A
33 mm <sup>2</sup> (2AWG)	:150 A	42 mm <sup>2</sup> (1AWG)	:200 A



# Wiring

## Power and Outputs

### Power terminal ( +12V )

Connect the fuse holder as close to the vehicle battery + as possible, using AWG 4 / 5 = 21 / 16 mm<sup>2</sup> power cable. Use a ring crimp terminal to connect to battery + and a fork terminal to connect to the amplifier + terminal. The AWG4 cable can use an 80 Amp fuse, if the cable is smaller, the fuse value must be lower (see table on previous page).

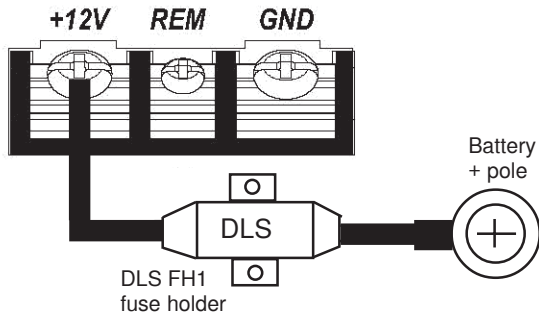

A cable up to AWG 4 (21 sq mm) fits the amplifier + 12 V terminal if using DLS FT22 fork terminals. Be sure to use a rubber grommet or a plastic insulating tube where the cable passes the firewall or other places where it can be easily jammed. Use wire ties to secure to existing cables in the engine compartment.

### Ground Terminal ( GND )

Connect to a good chassis ground. The ground connection should be clean, unpainted metal to provide a good electrical connection. Use a wire brush, a scraper or a piece of an abrasive sheet to clean the metal. Use a lock washer or two to secure contact. Protect with silicon grease or by paint applied afterwards.

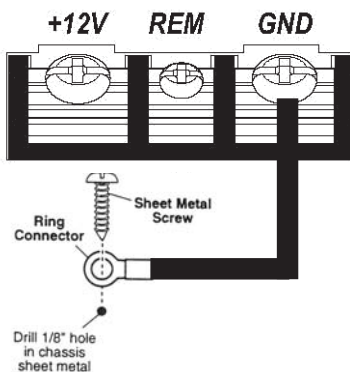

A cable up to AWG 4 (21 sq mm) fits the amplifier ground (GND) terminal if using DLS FT22 fork terminals.

### Fuses

Use only 25 ampere ATC blade type fuses when replacing a blown fuse.

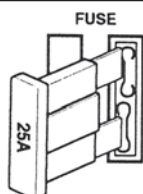

### Remote terminal ( REM )

#### For RCA cable signal input:

Connect the radio power antenna lead = remote turn on/off from the car stereo to the amplifier remote connection. This turns on the amplifier whenever the car stereo is turned on.

You can either use the built in remote cable in the RCA cable itself or use a separate cable.

Sometimes a small disturbance may enter the amplifier coming from the remote voltage , through the built in remote wire and into the RCA cable. Thus we recommend to use a separate remote wire and run the RCA lead separate from remote wire, power cables and speaker cables.

If there is no remote voltage available from the stereo, you must connect to the ignition key through the radio or any accessories fuse.

#### For High Level input:

We recommend you to connect the remote wire as described above. The amplifier will produce soft on / soft off operation this way.

In the case that there is no remote voltage available from the car stereo or you want to simplify the installation, the amplifier can be turned on/ turned off by the high level input voltage. This is done automatically when the head unit is turned on. There is a small disadvantage that this function gives soft turn on operation but some pop sound when switching off.

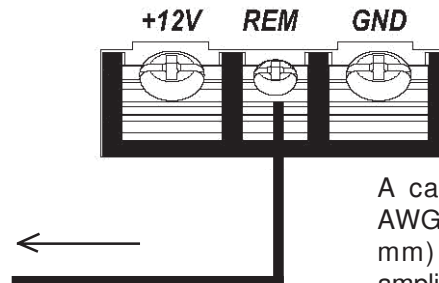

To head unit Power Antenna lead or remote output.

A cable up to AWG 7 (10 sq mm) fits the amplifier remote (REM) terminal if using DLS FT10 fork terminals.

### Power Light / Protect light

The power light (green ) comes on when the amplifier is turned on.

● Power (Green)

The protect light ( red ) comes on when the amplifier shuts down from overheating, or a short circuit ( speaker failure).

● Protect (Red)

Turn off your audio system to reset the amplifier if the red protect light is turned on. If the red lamp doesn't turn off, contact your local dealer for advice.



# Input and controls

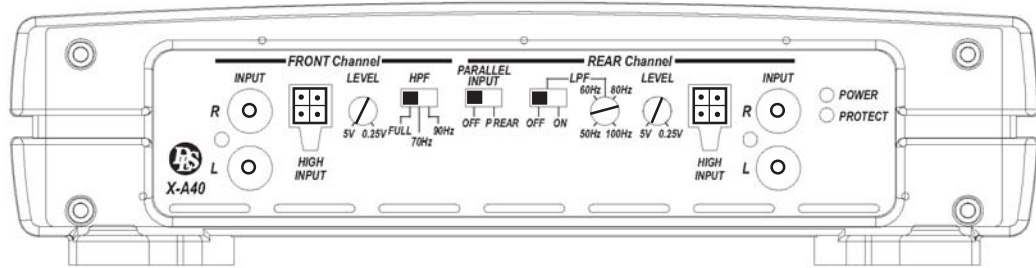

## Low level Input Wiring

Inputs may be low level from the RCA output of the car stereo or high level from the car stereo speaker output. Low level = RCA is to prefer for the best sound quality.

### Important

Use either the low level or high level input, do not use both at same time.

### Low level input

Use a pair of shielded stereo audio cables with RCA type jack. Most trunk-mount amplifiers need a 20 feet RCA cable (appr 5 – 6 meters). Most under the seat installations require 12 feet (2 – 3 meters) RCA cables. Avoid placing the RCA cable close to speaker cables, power cables and remote control cable. Connect to input socket **R / L**.

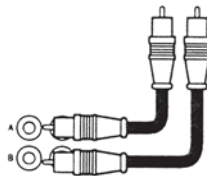

**X-A40** has dual inputs **Front R / L & Rear R / L**. Depending on your chosen configuration you can use either two separate RCA cables, or a single RCA cable together with an Y-split to connect both inputs.

**X-A30** has dual inputs, one for the stereo channels (Front Channel input **R / L**), and one for the mono channel (Sub Channel input **R / L**). Both inputs must be connected on the mono channel input socket.

## Parallel input on X-A30, X-A40

If you don't have dual line cables to Front & Rear channel inputs you can use a single line cable. Connect to the stereo Front input sockets and set the Parallel input switch to position **P SUB** (X-A30)

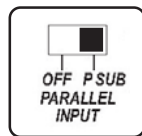

or **P REAR** (X-A40) and the signal is fed to both input sockets automatically.

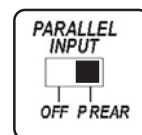

## High Level Input wiring

Connect left and right speaker wires coming from the car stereo to the high level input as shown. You must connect both plus and minus as the inputs are balanced, connecting plus only gives lower level and bad sound quality. By changing the polarity of plus and minus, you can change the phase.

### X-A10/20/30

On these models you connect as in this example:

High Input (Front Ch)



White: L ch.+  
White/Black: L ch.-  
Grey/Black: R ch.-  
Grey: R ch.+

### X-A30

On this model the high level signal is fed internally to SUB-channel when using high level input and the Parallel input switch in position **P SUB**.

### X-A40

The four channel amplifier is connected likewise, however we have four channels.

You can feed two channels from RCA and two channels using high level input from rear speaker cables, or all channels from high level input.

### High level input socket and plugs.

High Input (Front)

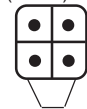

White: L ch.+  
White/Black: L ch.-  
Grey/Black: R ch.-  
Grey: R ch.+

Hi level input plug for Front channels.

High Input (Rear)

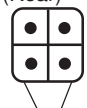

White: L ch.+  
White/Black: L ch.-  
Grey/Black: R ch.-  
Grey: R ch.+

Hi level input plug for Rear channels.

### Automatic turn on when using high level input.

The amplifier turns on automatically when using high level input, you don't need to connect a separate remote wire from your head unit.

For a soft turn ON /OFF operation we recommend you to use a remote wire, if this is available.



## Input Level control

The input level control, 5V – 0,25 V, matches the output of your radio to the input of the amplifier. After installation is complete, make sure the input of the amplifier is turned down all the way to 5V.

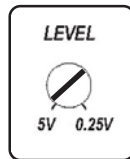

Play a CD, make sure all bass or treble settings or equalizer are flat, and turn the volume of the radio up until you just start to hear distortion. Turn the volume control down just a bit. Increase the input level control on the amplifier ( clockwise or to the right ) until you just start to hear distortion, then back the level control just a bit. Now your radio and amplifier levels are matched.

## High Pass filter (HPF) - All models

The high pass filter blocks very low frequencies from reaching the speakers. It is mostly used to protect small speakers ( like 5 inch and smaller ) from deep bass.

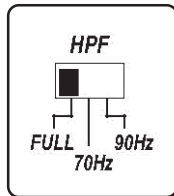

Set the switch in position 70 Hz or 90 Hz to activate the filter. Test which setting sounds best.

The filter can be set at **FULL** position if you want to run the amplifier in full range mode without limiting the frequency range.

## Low Pass filter (LPF)

The low pass filter is mostly used for subwoofers. It will allow low frequencies only and blocks higher frequencies. A typical setting is 60 – 70 Hz.

Set the switch in **ON** position to activate the filter. Set the switch in **OFF** position if you want to run the amplifier in full range mode. X-A30 has no switch.

The frequency range of the LP-filter is different on each model, see the drawings on the right.

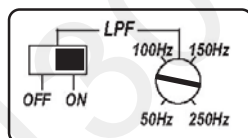

X-A10

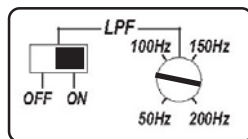

X-A20

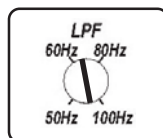

X-A30

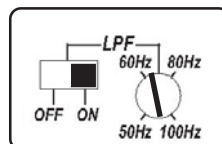

X-A40

## Crossovers/filters and other features on each model

The **X-A10** is a mono channel amplifier mainly intended for use with one or two subwoofers but can also be used in full range mode.

**The amplifier has the following filters / features:**

- Lowpass filter adjustable between 50 and 250 Hz, the filter can be switched off.
- Highpass filter selectable FULL - 70 Hz - 90 Hz.
- Internal subsonic filter fixed to 25 Hz.

The **XA20** is a 2-channel amplifier. Can be used for a pair of stereo speakers or a subwoofer counted in mono bridge mode.

**The amplifier have the following filters / features:**

- Lowpass filter adjustable from 50 to 200 Hz, the filter can be switched off.
- Highpass filter selectable FULL - 70 Hz - 90 Hz.
- Internal subsonic filter fixed to 25 Hz.

The **X-A30** is a 3-channel amplifier for use with a front system and a subwoofer.

**The amplifier has the following filters / features:**

**Stereo section (front channels):**

- High pass filter selectable FULL - 70 Hz - 90 Hz.

**Mono section (Sub channel):**

- Lowpass filter adjustable between 50 and 100 Hz.
- Internal subsonic filter fixed to 25 Hz.

The **X-A40** is a 4-channel amplifier for use with a front system and a subwoofer, or two front systems.

**The amplifier has the following filters / features:**

- Lowpass filter adjustable from 50 to 100 Hz, the filter can be switched off.
- Highpass filter selectable OFF - 70 Hz - 90 Hz. The filter can be turned off for running the amplifier in full range.
- Internal subsonic filter fixed to 25 Hz.

## Subsonic filter - All models

All models include a **Subsonic filter that** blocks the very deepest frequencies from reaching the speakers. The cutoff frequency is 25 Hz. The filter is internally connected on all models and can not be switched off.





## Crossovers/filters and other features on each model

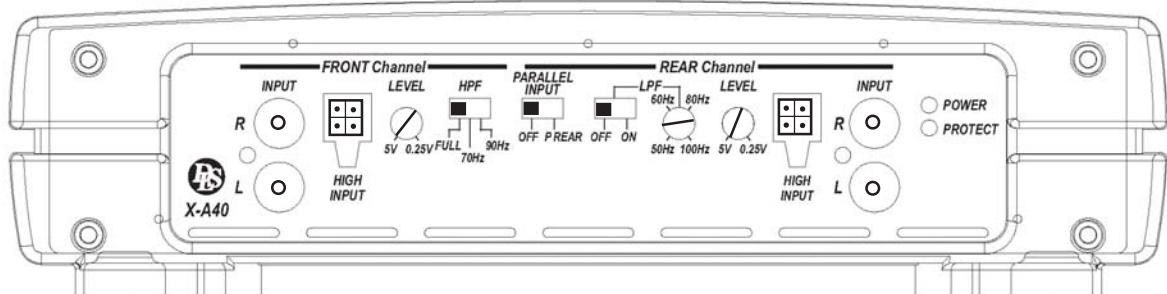
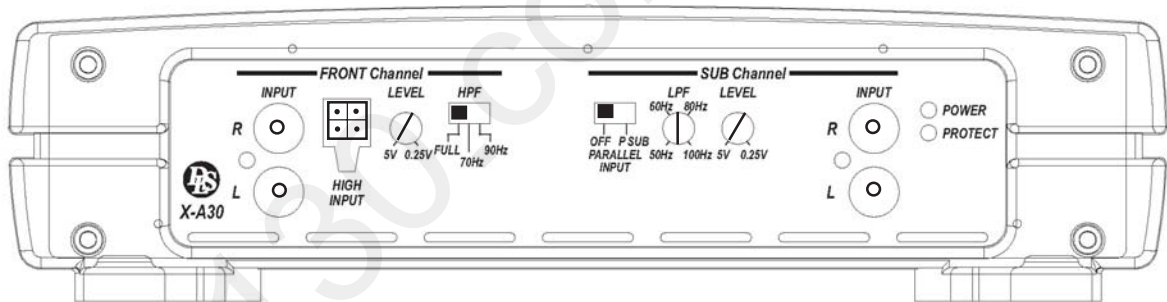
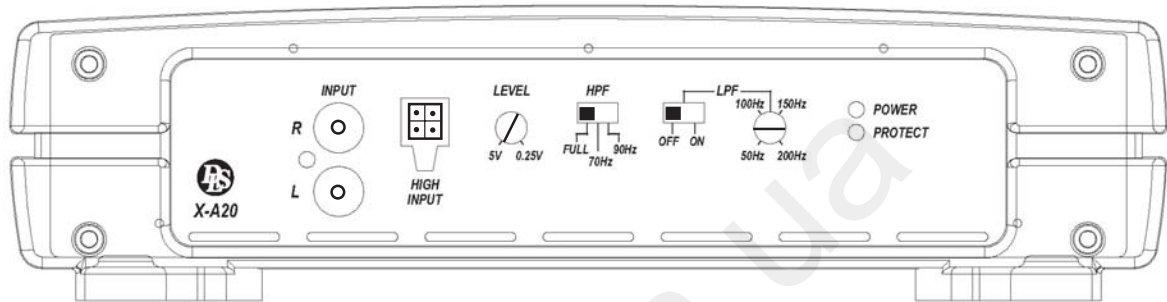
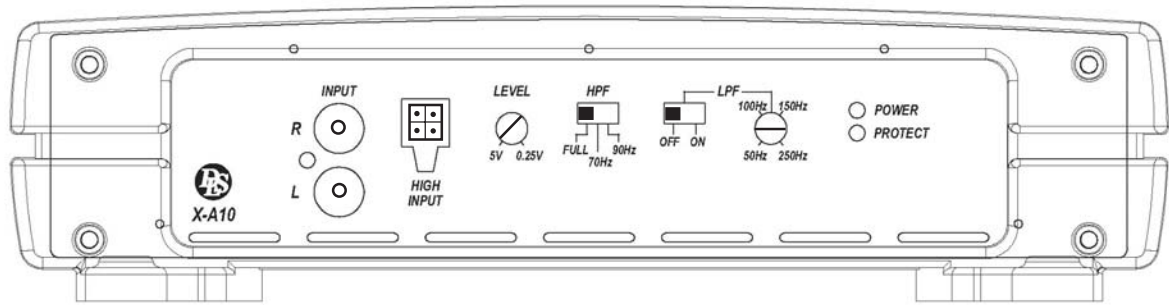



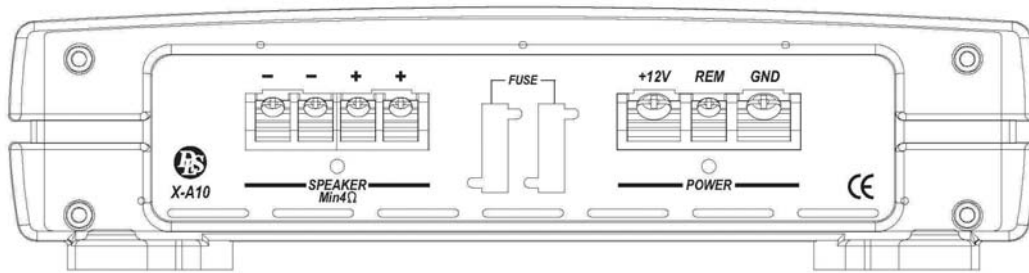

### Speaker wiring X-A10

#### Single 4 ohm subwoofer

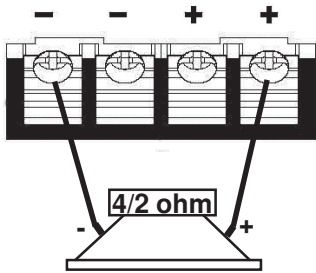

**NOTE!**

The speaker terminal has dual + and - terminals for easier connection if you have more than one subwoofer. They are internally connected in parallel and can not be bridged.

**NOTE!**

Minimum amplifier load is 2 ohm, this connection gives a 4 ohm load with a 4 ohm subwoofer.

#### Two 4 ohm subwoofers

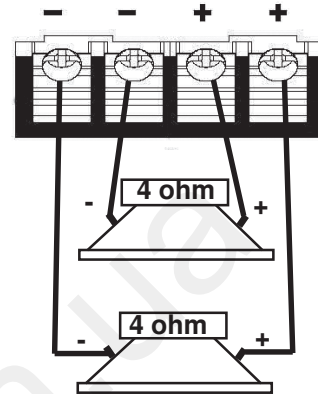

**NOTE!**

Minimum amplifier load is 2 ohm, lower impedances may damage the amplifier. This connection gives a 2 ohm load with two 4 ohm subwoofers.

#### Filter settings

The low pass filter (LPF) is mostly used for subwoofers. It will allow low frequencies only and blocks higher frequencies. A typical setting is 60 – 70 Hz.

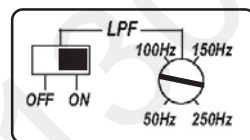

Set the switch to **ON** position to activate the filter. Use this position when connected to subwoofers. Set the switch to **OFF** position if you want to run the amplifier in full range mode.

The high pass filter (HPF) blocks very low frequencies from reaching the speakers. It is mostly used to protect small speakers ( like 5 inch and smaller ) from deep bass.

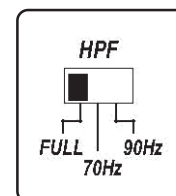

Set the switch in position 70 Hz or 90 Hz to activate the filter. Test which setting sounds best. The filter can be set at **FULL** position if you want to run the amplifier in full range mode without limiting the frequency range. If you use the amplifier for subwoofers, set the switch to position **FULL**.

For power wiring, see page 4  
For High or low level input wiring, see page 5

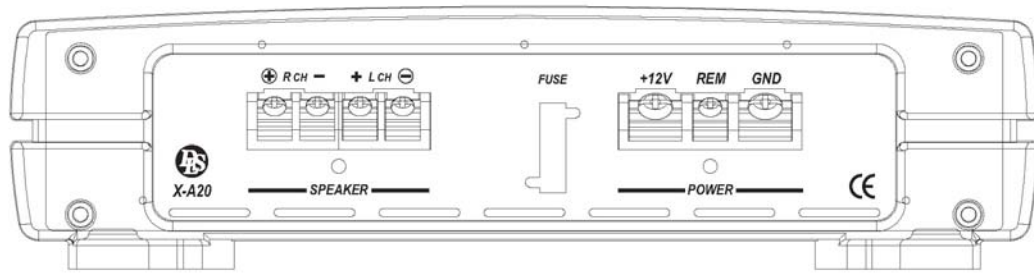

### Speaker wiring X-A20

#### Two fullrange speakers to channel R / L

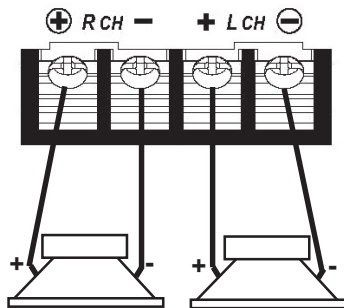

**NOTE!**

Minimum amplifier load is 2 ohm in stereo mode, lower impedances may damage the amplifier.

#### Filter settings CH R/L for 2-channel stereo use

The high pass filter (HPF) blocks very low frequencies from reaching the speakers. It is mostly used to protect small speakers ( like 5 inch and smaller ) from deep bass.

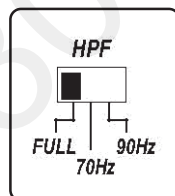

Set the switch in position 70 Hz or 90 Hz to activate the filter. Test which setting sounds best. The filter can be set at **FULL** position if you want to run the amplifier in full range mode without limiting the frequency range. If you use the amplifier for subwoofers, set the switch to position **FULL**.

For power wiring, see page 4  
For High or low level input wiring, see page 5

#### One 4 ohm subwoofer bridged

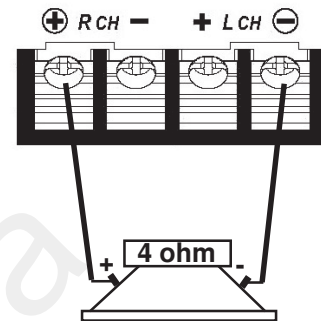

**NOTE!**

Minimum speaker impedance in bridged connection is 4 ohm, this connection gives a 2 ohm load with a 4 ohm subwoofer. The load is halved when connected in bridge mode.

Do **NOT** use subwoofers with lower impedance than 4 ohm.

Connect speaker + to R ch+ and speaker - to L ch -.

#### Filter settings CH R/L for subwoofer use

The low pass filter (LPF) is mostly used for subwoofers. It will allow low frequencies only and blocks higher frequencies. A typical setting is 60 – 70 Hz.

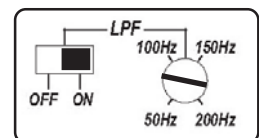

Set the switch to **ON** position to activate the filter. Use this position when connected to subwoofers. Set the switch to **OFF** position if you want to run the amplifier in full range mode.

When using the amplifier for subwoofers, set the **HPF**-switch to position **FULL**.

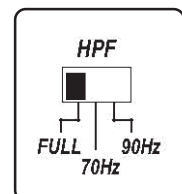

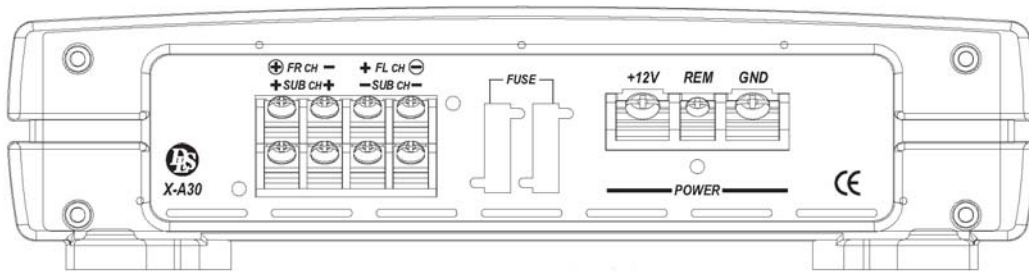

### Speaker wiring X-A30

#### 1. Two fullrange speakers to the front channels

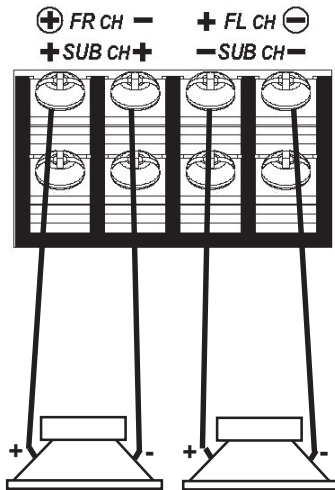

Connect to the upper terminals for **FR CH** and **FL CH**.

#### Filter settings R & L - stereo channels

The high pass filter (**HPF**) blocks very low frequencies from reaching the speakers. It is mostly used to protect small speakers ( like 5 inch and smaller ) from deep bass.

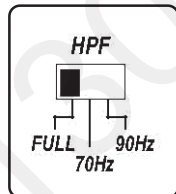

Set the switch in position **70 Hz** or **90 Hz** to activate the filter. Test which setting sounds best. The filter can be set at **FULL** position if you want to run the amplifier in full range mode without limiting the frequency range.

For power wiring, see page 4  
For High or low level input wiring, see page 5

#### One or two subwoofers to sub channels, Each speaker min 4 ohm.

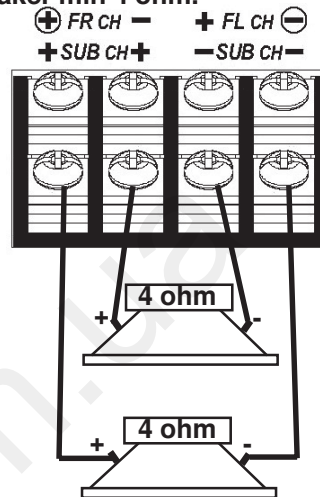

Connect to the lower terminals for **SUB CH + and -**. **NOTE!**

Minimum amplifier load is 2 ohm, lower impedances may damage the amplifier. This connection gives a 2 ohm load with two 4 ohm subwoofers.

#### Filter settings -Sub channel

The low pass filter (**LPF**) is used for subwoofers. It will allow low frequencies only and blocks higher frequencies. A typical setting is 60 – 70 Hz.

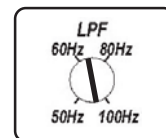

The **LPF** filter can not be switched **OFF**.

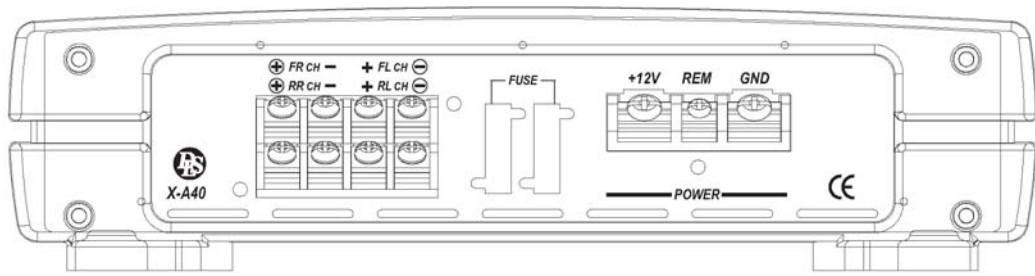

### Speaker wiring X-A40

1. Four fullrange speakers to X-A40. One pair in front and one pair in rear.

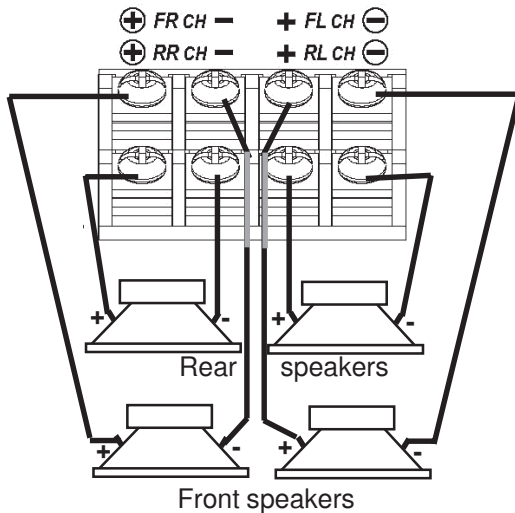

Front and rear stereo speakers connected to front & rear channels

#### Filter settings front channels FL / FR

The high pass filter (HPF) blocks very low frequencies from reaching the speakers. It is mostly used to protect small speakers (like 5 inch and smaller) from deep bass.

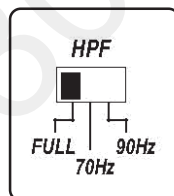

Set the switch in position 70 Hz or 90 Hz to activate the filter. Test which setting sounds best. The filter can be set at **FULL** position if you want to run the amplifier in full range mode without limiting the frequency range.

#### Filter settings rear channels RL / RR

The LPF filter must be in position **OFF**

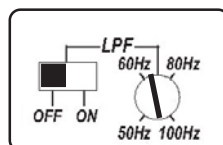

For power wiring, see page 4  
For High or low level input wiring, see page 5

2. Two fullrange speakers and one subwoofer bridged to X-A40.

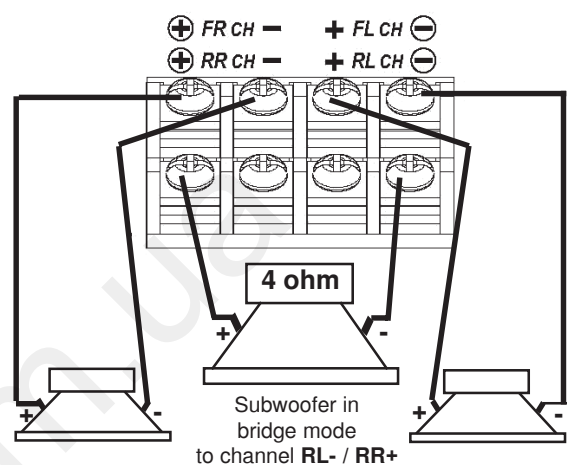

Rear or front stereo speakers connected to channels FL / FR

#### Filter settings front channels FL / FR

The high pass filter (HPF) blocks very low frequencies from reaching the speakers. It is mostly used to protect small speakers (like 5 inch and smaller) from deep bass.

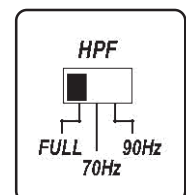

Set the switch in position 70 Hz or 90 Hz to activate the filter. Test which setting sounds best. Or set the switch in **OFF** position. Listen and judge yourself what sounds best in your installation.

#### Filter settings rear channels RL / RR

The low pass filter (LPF) is mostly used for subwoofers. It will allow low frequencies only and blocks higher frequencies. A typical setting is 60 – 70 Hz.

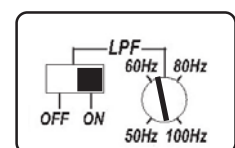

Set the switch to **ON** position to activate the filter. Use this position when connected to subwoofers.





# Testing

Before you finish the installation, you should do the following tests to make sure the wiring is correct and everything is operating properly.

## Reconnect Battery

When wiring is complete, reconnect the battery negative terminal.

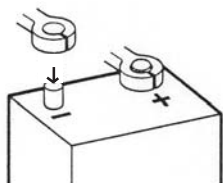

## Test power wiring

1. Turn on the head unit but do not turn up the volume. The amplifier power light should come on. If not, check the remote and +12 volt wires. Also check the ground connection.
2. Turn up the head units volume slightly. All speakers should operate. If not, check wiring connections at amplifier and speakers.

## Test speaker connections

Make sure the speakers are connected right. Use the balance control on the head unit to make sure right channel is on right speaker etc. If speakers don't play at all, one or both speaker wires may be disconnected.

# Troubleshooting

If problems occur during the installation, or later, this guide might help you to find out what's wrong.

## THE AMPLIFIER IS DEAD:

1. Check power lead, ground and remote connections at the amplifier using a multi meter.
2. Check the battery terminal connections.
3. Check the power lead fuse or circuit breaker. If fuse damage continues, inspect the power lead for short circuits.
4. Check the amplifier protection fuses. Are these broken change to new ones with the same value. If short circuiting continues, contact your local DLS dealer. A fault may exist in the amplifier.
5. To start the amplifier requires a remote voltage of 9-15 volt. Check the voltage with a multi meter.

## AMPLIFIER PROTECTION FUSE BLOWS AT LOW VOLUME :

1. One or more speaker cables are shorted. Make an insulation test with a multi meter. The cables must not have a connection to earth.

## THE AMPLIFIER TURNS OFF AFTER 10 - 30 MINUTES.

The amplifier is overheating due to inadequate ventilation. Check mounting position is free from obstruction.

### Do this:

1. Move the amplifier to a place with better ventilation.
2. Install one or two fans to cool down the heat-sink.
3. Overheating can also be caused by an impedance load below the level permitted.

## NO OUTPUT FROM ONE OR MORE SPEAKERS:

### Check the following:

1. Balance control position.
2. Fader control position.
3. Speaker cable connections to both amplifier and drivers.
4. Signal lead plugs and cables.
5. Change left and right signal lead plugs in the amplifier to see if the problem moves to a different speaker, the lead has a fault. If the problem remains, the speaker or amplifier are at fault.



### Professional Tip:

#### NOISE PROBLEMS

WHINING NOISE VARYING WITH ENGINE REVOLUTIONS:

##### Do this:

1. Rewire the power supply (12 V) to source unit direct from battery.
2. Rewire ground wire from source unit to clean position on chassis.
3. Check all power connections to ensure that they are clean and tight.
4. Check quality of system ground connection.
5. Install a Power Cap capacitor. This can be helpful against most noise problems.

##### CONSTANT WHINING NOISE:

##### Do this:

1. Ensure that all equipment has a common ground point.
2. Check quality of earth strap connection from battery negative terminal to chassis.
3. Disconnect signal cables from amplifier to see if noise disappears. If so the leads are picking up noise. Test this by laying a new cable over the seats and reconnecting to the amplifier. If the noise does not return, re-route original cable away from source of interference.

If noise remains regardless of cable position, try to use so called Quasi-balanced signal cables. DLS PRO-cables are Quasibalanced.

### Professional Tip:

#### SPEAKER POLARITY CHECK.

All speakers in a car audio system should be connected in phase (the same polarity). All speaker cones must move in the same direction. Out of phase speakers will cause a lack of bass, and a poor stereo soundstage.

##### Checking polarity:

Hold the - connection of the speaker wire to the - terminal of a 1,5 Volt flashlight battery. Tap the + wire on to the + terminal of the battery, and observe the movement of the cone. The cone should move outwards when the wire touches the battery, and inwards when the battery is removed. If it is the other way around, the speaker has been connected backwards and it must be removed and connected correctly.

If your system also has a subwoofer connected through a passive 6 or 12 dB crossover, try to connect this with various polarity and judge what sounds best. The phase shift in passive crossovers sometimes makes it necessary to change polarity.

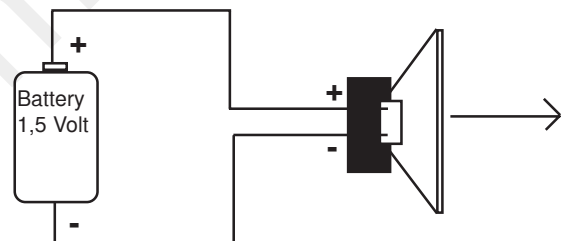

**NOTE!** Tweeters can not be tested this way, double check the connections instead.

### Professional Tip:

#### Installing in trunk

When installing the amplifier in the trunk, run the power wires along the same path as the other vehicle wiring. Many cars have insulated channels for wiring. you will have to remove the door sill trim and the carpet.

### Professional Tip:

#### Securing wires

Use wire ties to bundle together when possible. (But never bundle speaker wires or signal cables together with power wires.)

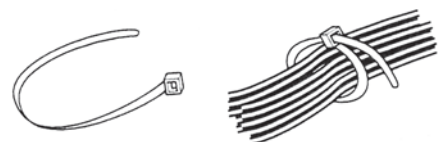

### Professional Tip:

#### Crimp connections

Purchase crimp connectors and crimping tool. Connectors are color coded.

1. Strip 1/4 inch (6 mm) of insulation from the wire.
2. Insert into connector
3. Crimp tightly

### Professional Tip:

#### Speaker and power wires

Do not run speaker and power wires next to each other. Power wires can generate a "siren" sound in the speakers. Run speaker and power wires on opposite sides of the car.



# Specifications

X-program	X-A10	X-A20
Number of channels	1	2
Amplifier class	AB	AB
Power output, 4 ohm (0,1% THD)	200 W	2 x 50 W
Power output, 2 ohm (0,2% THD)	300 W	2 x 70 W
Power output, 4 ohm bridged	N/A	1 x 140 W
Signal to noise ratio, A-weighted	>90 dB	>90 dB
Damping factor	>80	>80
Frequency response	20 Hz - 30 kHz	20 Hz - 30 kHz
Input impedance, low level	22 kohm	22 kohm
Input impedance, high level	220 ohm	220 ohm
High level input with auto start	Yes	Yes
Parallel input switch	-	-
Input sensitivity	0,25 - 5V	0,25 - 5V
Filter subsonic @ 25 Hz	Yes	Yes
Filter high-pass	Off / 70 / 90 Hz	Off / 70 / 90 Hz
Filter low pass variable	50-250 Hz*	50-200 Hz *
* can be switched in/out	(18 dB/oct)	
Built-in fan cooling	Yes	-
Power consumption, idle	0,8 A	0,4 A
Power consumption, max	65A	35A
Fuse	2 x 25 A	1 x 25 A
Dimensions HxWxD(mm)	72 x 255 x 358	72 x 255 x 278
Dimensions (inch)	2,8 x 10 x 14	2,8 x 10 x 10,9
Weight	3 kg	2,3 kg

All above output power ratings at 14,4 VDC

X-program	X-A30	X-A40
Number of channels	3	4
Amplifier class	AB	AB
Power output, 4 ohm (0,1% THD)	2 x 50 W	4 x 50 W
Power output, 2 ohm (0,2% THD)	2 x 70 W	4 x 70 W
Power output, 4 ohm bridged	1 x 140 W	2 x 140 W
Power out mono sub ch. 4 ohm	1 x 120 W	N/A
Power out mono sub ch. 2 ohm	1 x 180 W	N/A
Signal to noise ratio, A-weighted	>90 dB	>90 dB
Damping factor	>80	>80
Frequency response	20 Hz - 30 kHz	20 Hz - 30 kHz
Input impedance, low level	22 kohm	22 kohm
Input impedance, high level	220 ohm	220 ohm
High level input with auto start	Yes	Yes
Input sensitivity	0,25 - 5V	0,25 - 5V
Filter high pass, front channels	Off / 70 / 90 Hz	Off / 70 / 90 Hz
Filter low pass, rear channels		50 - 100 Hz*
Filter low pass Sub channel	50 - 100 Hz	
Filter subsonic @ 25 Hz	Yes, on all channels	Yes, on all channels
* can be switched in/out		
Power consumption, idle	0,7 A	0,5 A
Power consumption, max	50 A	50 A
Fuse	2 x 25 A	2 x 20 A
Dimensions HxWxD(mm)	72 x 255 x 378	72 x 255 x 398
Dimensions (inch)	2,8 x 10 x 14,9	2,8 x 10 x 15,7
Weight	3,2 kg	3,5 kg

We follow a policy of continuous advancement in development.

For this reason all or part of specifications & designs may be changed without prior notice.

130.com.ua



130.com.ua

**DLS Svenska AB**  
**P.O. Box 13029**  
**SE-40251 Göteborg, Sweden**  
**Tel: +46 31 840060**  
**Fax: +46 31 844021**  
**E-mail: [info@dls.se](mailto:info@dls.se)**  
**[www.dls.se](http://www.dls.se)**