



PHONES

(044) 360-7-130
(050) 336-0-130
(063) 788-0-130
(067) 233-0-130
(068) 282-0-130

130 Internet store of autogoods

COM.UA



ICQ
294-0-130
597-0-130

SKYPE
km-130

CAR RECEIVERS — Receivers • Media receivers and stations • Native receivers • CD/DVD changers • FM-modulators/USB adapters • Flash memory • Facia plates and adapters • Antennas • Accessories |
CAR AUDIO — Car audio speakers • Amplifiers • Subwoofers • Processors • Crossovers • Headphones • Accessories | TRIP COMPUTERS — Universal computers • Model computers • Accessories |
GPS NAVIGATORS — Portable GPS • Built-in GPS • GPS modules • GPS trackers • Antennas for GPS navigators • Accessories | VIDEO — DVR • TV sets and monitors • Car TV tuners • Cameras • Videomodules
• Transcoders • Car TV antennas • Accessories | SECURITY SYSTEMS — Car alarms • Bike alarms • Mechanical blockers • Immobilizers • Sensors • Accessories | OPTIC AND LIGHT — Xenon • Bixenon • Lamps
• LED • Stroboscopes • Optic and Headlights • Washers • Light, rain sensors • Accessories | PARKTRONICS AND MIRRORS — Rear parktronic • Front parktronic • Combined parktronic • Rear-view mirrors
• Accessories | HEATING AND COOLING — Seat heaters • Mirrors heaters • Screen-wipers heaters • Engine heaters • Auto-refrigerators • Air conditioning units • Accessories | TUNING — Vibro-isolation
• Noise-isolation • Tint films • Accessories | ACCESSORIES — Radar-detectors • Handsfree, Bluetooth • Windowlifters • Compressors • Beeps, loudspeakers • Measuring instruments • Cleaners • Carsits
• Miscellaneous | MOUNTING — Installation kits • Upholstery • Grilles • Tubes • Cable and wire • Tools • Miscellaneous | POWER — Batteries • Converters • Start-charging equipment • Capacitors
• Accessories | MARINE AUDIO AND ELECTRONICS — Marine receivers • Marine audio speakers • Marine subwoofers • Marine amplifiers • Accessories | CAR CARE PRODUCTS — Additives • Washer fluid •
Care accessories • Car polish • Flavors • Adhesives and sealants | LIQUID AND OIL — Motor oil • Transmission oil • Brake fluid • Antifreeze • Technical lubricant



In store "130" you can find and buy almost all necessary goods for your auto in Kyiv and other cities, delivery by ground and postal services. Our experienced consultants will provide you with exhaustive information and help you to chose the very particular thing. We are waiting for you at the address

<http://130.com.ua>



DOD
™

Dream Of Digit-tech

F900HD

12 MEGA PIXELS PHOTOGRAPH

FULL HD HIGH DEFINITION VIDEO CAMCORDER

USER MANUAL

Autogood products "130"

130.com.ua

Autogood products "130"

Table of Contents

Preface	1
Assurance	1
Summary	2
Features	3
Configuration	5
Installation	6
Operation Instruction	8
Storage & Video replay	14
Key & Icon	15
Setting	19
Specification	20
Accessories	21
Troubleshooting	22
Installation	23

Table of Contents

前言	26
產品保證	26
產品概述	27
產品特性	28
產品結構	30
使用安裝	31
操作指南	33
文件儲存及視訊播放	39
按鍵功能及功能圖示	40
設定目錄	44
產品參數	45
包裝附件	46
簡易問題排除	47
資料安裝說明	47

Preface

Thank you for purchasing F900HD, high definition digital camcorder. The Products appearance is mini with elegant impression. The unique Screen-rotation function and movable lens unitized design realizes with multi-purpose uses.

This user manual provides full instructions for the usage of the products. At the same time, gives you the details of the products, such as operation, warning installation, and product specification. Please read this manual carefully and full understand before using this product, keep this manual in the safe place. we hope our product could meet your need. and wish to serve you for long-term.

Assurance

This product has passed ISO 9001:2000 international quality control system authentication and achieve all the standards set by the authorities of FCC, CE&SGS with certificates to assure safety for our great customers.

Summary

This high-tech mini HD digital camcorder is designed for market demand. This product has the most leading functions for the industry such as HD digital video, digital photo, USB data transfer, USB charger. It has many inventions and the technical monopoly.

Wide range of applications, memorize every wonderful moment . . .



Features

- Mini size, with screen-Rotation design cooperates with multi-function use, help you see HD videos and photoes easily on the screen in every situation. Catch the high definition pictures at will, and display and play back at real time.
- **2.5** inch LTPSTFT LCD.
- **1/2** "high definition video sensor parts
- **4** picese fixed lens; focus range: 10cm-infinity .
- **4 X** digital zoom
- Electronic Auto Flash light(led), optional flash on for illumination.
- Video format : MPEG-4AVC / H.264
- Mic and Speaker equipped.
- High capacity Lithium-ion rechargeable battery.
- Support SDHC card.
- HDMI Port : Suitable for high definitionTV.
- Loop video recording functions.
- Set video recording time freely.
- Set 180-degree reverse shot lens.
- Record when get power supply.
- Can be set to automatically start recording when the car engine starts.
- Screen sleeping mode.

Video Storage Capacity (for reference)

	Memory card(Gbyte)			
	1G	2G	4G	8G
1920X1080 (FPS30)	10min	20min	40min	80min
1440X1080 (FPS30)	16min	32min	64min	128min
1280X720 (FPS30)	20min	45min	90min	180min
848X480 (FPS60)	21min	42min	84min	168min
848X480 (FPS30)	32min	64min	128min	256min
640X480 (FPS30)	66min	133min	266min	533min
320X240 (FPS120)	47min	94min	188min	376min
320X240 (FPS30)	188min	376min	752min	1504min
3 M	957photos	1914photos	3828photos	7656photos
4 M	672photos	1344photos	2688photos	5376photos
5 M	586photos	1148photos	2386photos	3996photos
8 M	386photos	753photos	1565photos	3193photos
12 M	300photos	600photos	1200photos	2400photos

- File size and storage capacity might differ from one model to others due to the differences existing in different models, brand of memory card and other settings.

Configuration

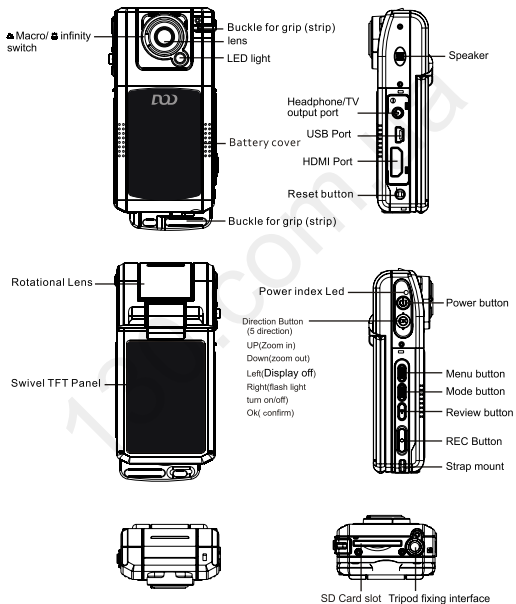

Autogood products "130"

Instruction

• Inserting and Taking out battery

1. Open battery cover by pushing it down.
2. Insert battery according to the "+" marks to the right positions.
3. Please refer to the following diagrams for battery status.



Full percentage



low percentage



critical percentage

4. The battery cover must be open before taken out the battery.

• Charging the Battery

- 1 Using the charger: One end of the USB cable connected with the charger, and the other end plugged into the USB port of the camcorder.
- 2 Using USB cable to recharge : Use USB cable to connect computer screen, the screen appears as following picture: select the "CHARGE" to begin charging.

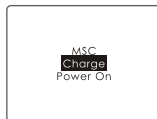
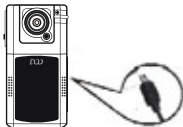

- **Inserting & Taking out Memory Card(SDHC Card)**

1. Carefully insert the memory card into card slot until the card is tightly fixed.
2. To remove the SD card out, push the card softly, and then it will bounce out.

NOTE :

1. Before using SD card, Please check if it is locked;
2. Please make sure SD card is inserted to the right direction.
If inserted to the opposite direction, it might cause damage to both camcorder and SD card.
3. After SD card has been inserted into the card slot, F900HD will automatically take SD card as default storage, therefore all the data stored before inserted can not be read until it has taken out.
4. If the memory card is not compatible with F900HD, the card might not be read. In this case, take out the card and insert it again or just change to another SD card.

Operation Instructions

• **Setting mode**

- 1.Regarding to video/photo/review mode, press "Menu" button could enter into any corresponding setting menu.
(For details in setting information, please refer to the setting table).
- 2.At any menu mode, press direction key rightwards will enable user for menu setting options to choose preferred setting , then press "ok" to confirm.

• **Turn on/off F900HD Camcorder and Automatic shut-off setting**

- 1.Press power button for 1 second to turn on/off.
 - 2.In order to save the power of the battery, auto off can be set in the "setting menu". If no operation is conducted during the time setting, period , the F900HD will turn off automatically.
- Turn on F900HD, under any mode, press "menu" to select "System Setup", press direction key downwards to select " Auto off " and then press the right key to change the auto off period.

• Setting Date and Time

1. Turn on F900HD, under any mode, press "menu" button to select "System Setup ", press direction key downwards to select "Date&Time", and then select the right year, month, day, hour, minute, press the arrow keys to adjust time to set up.

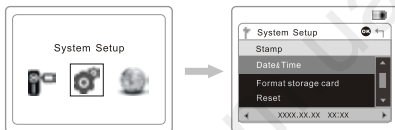

2. Under video mode, press "menu" button to select "System Setup", press direction key down wards to select the "Stamp", set to "On", the time and date will be displayed on the video.



• Video mode

- 1.F900HD automatically goes to video mode after it is turned on.
At this time "  HD" appears upper left corner of the screen.







- 2.Press the "REC" button to start recording, then press "REC" button to stop recording. During recording, timer and " ● " symbol shown on the screen and it will flash for timing and recording. As soon as the recording stops, the flash red circle turns back to the "  " .

3.Options for flashing light

Press Speed flash switch button(right Key) at the F900HD can start or stop using Auto Flash "  " (which can automatically make up the light according to different conditions) or Fill "  " (every time you take a picture, flash is used regardless of light conditions).

Attention : LED light function will automatically turn off when the battery at critical percentage.

- 4.Using  /  switch : under  macro mode for photography distance to focus on the small items, the effective distance is 10 cm, under  infinity mode photography distance from 1.5 m to infinity.

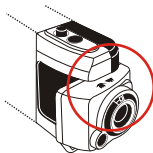

Autogood products "130"

• Photograph mode

1. Press power key to turn on F900HD and it will go to video mode automatically, Press "mode" switch to the Photograph mode, The upper left corner of the screen will show "8M" and the button of the screen will display the maximum photo capacity.



2. Alignment by F900HD to the object which to be taken, using direction key upwards and downwards in order to adjust focus.
3. While pressing record button, camera makes a sound, the sound signifies that the recording is finished.
4. Self-timer
Under camera mode, press "menu", then press direction key down wards to select "Image Param", press right wards to choose "Self timer" time in order to take the picture.

Tips: 1. Under any mode (video, camera), press "mode" could change the mode "video"/"camera" circularly.

2. Under video and photography mode, press direction key leftwards could enter screen sleep mode.

• Review mode

1. Turn on F900HD to Video mode, Press review key to enter into single-picture review mode, Press direction key leftwards and rightwards to review pictures or recorded video.
2. Press direction key downwards to index review mode. User can press direction key to review taken pictures or videos. Press "ok" to enter single-picture review mode, and Press "mode" to exit.
 - If displayed picture is tagged with "▶", then it symbolize a video information, Pressing "ok" will play the video, press ok again, it will pause. While playing video, you can use direction key left or right to forward or backward playing, To exist playing mode, you have to press "ok" to pause the playing video first, and then press direction key left or right to go to the next file.
3. Truncation chart function
When you see the "current picture" while reviewing video, then press "ok" to pause the video then press record button, until the sound is coming out. This "current picture" will recorded to be a photo in your storage file, Then press "ok" for continuing review video.
4. Delete
While reviewing (reviewing pictures/video), press "menu", then delete key will appear on the screen, Press "ok" to delete the displaying video or picture, and press the direction key right to choose deleting file, then press "ok" to confirm.
5. Slide Review
During review condition (play/record), you may select "menu" key, then press downwards button to set for "slide review". Then press "ok" to confirm.

- **Record when get power supply**

Connect USB power backup battery with the camcorder , then the screen appears as following , select the "POWER ON", at this time can be used normally, which is charged from an external power supply (Not charging)

Tips : Any case, disconnect the USB, the camcorder will automatically shut down

- **Screen sleep mode**

In the photography or camera video capture mode , press left key , you can enter into the screen sleep mode , press left key once again reverted to the original mode.

- **TFT display swivel instruction image**



File backup

• USB backup Mode

With USB cable connected to the machine and computer, this time the screen appears as following: select "MSC", open the desktop "My Computer", there are two removable disks (one is internal memory, the other one is the SD memory card) : Under the "Removable Disk / DCIM/100MEDIA" path to find the stored movies. If you do not insert the SD card, internal memory corresponding to as a removable disk..

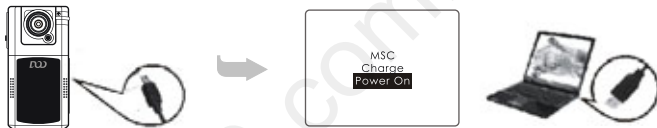

• Connecting F900HD to TV

- 1.Connecting F900HD to HDTV with an HDMI cable to review pictures and videos.
- 2.Connecting F900HD to television with TV cable to review pictures and video.

Tips:

No driver is needed to be installed. Removable disk can be used only when the video camera is on.

Function keys

Video/camera mode

Power Button Turn on or off F900HD

Shutter Button video recording/pause

Direction Button(Up) 1 / 2 / 3 / 4 Digital zoom
(1080 P video recording can not be used)

Direction Button(Down) 4 / 3 / 2 / 1 Digital zoom
(1080 P video recording can not be used)

Direction Button(Left) Screen sleep mode

Direction Button(Right) Transformation for LED
light : Auto/Compulsion /Off

Menu Button Menu option

Mode Button Mode option

Playback Button Pictures and video review

Review Mode ●

Preview Mode(single-picture)

Power Button	Turn off F900HD
Direction Button(Down)	Index graphical representation
Direction Button(Left)	Last page
Direction Button(Right)	Next page
Ok Button	video playing
Menu Button	Menu Option
Mode Button	Mode Option
Play back Button	Review pictures and video informations

Preview(index graphical representation)

Power button	Turning off F900HD
Direction Button(Up)	Previous line /Last page
Direction Button(Down)	Next line /Next page
Direction Button(Left)	Last picture / video
Direction Button(Right)	Next picture / video
Ok Button	Enters the document broadcast pattern
Menu Button	Menu option
Mode Button	Mode option
Play back Button	Review pictures and video informations

Mode & Menu Setting



























Reviewing(Video/Audio)

Power button	Turning off video camera
Direction Button(Up)	Volume+(0-8)
Direction Button(Down)	Volume-(8-0)
Direction Button(Left)	Backward 2,4,8 times
Direction Button(Right)	Forward 2,4,8 times
OK Button	Play/Pause(no matter forward/backward)
Menu Button	Go to review menu
Mode Button	Stop playing and going into video mode
Play back Button	Review pictures and video informations

Reviewing(Pictures)

Power button	Turning off F900HD
Direction Button(Down)	Zoom out(index pictures)
Direction Button(Left)	Last picture
Direction Button(Right)	Next picture
OK button	Go into Single picture play mode
Menu Button	Go to review menu
Mode Button	Stop playing and go into video mode
Play back Button	Review pictures and video informations

- While using this product, you will find a lot of symbols and icons. In order to enable you to understand this product, please refer to the following table

	Video recording		Auto Flash		Sunny
	Photography		Compulsion Flash		Cloudy
	Play		Flash off		Tungsten
	System Setting		Fluorescent		Memory Card
	High Definition		Picture size is 3M		Picture size is 4M
	Picture size is 5M		Picture size is 8M		Picture size is 12M
	Battery percentage		WVGA		QVGA
	VGA		Burst		Self timer
	MIC OM		MIC OFF		

Setting

	Mode	Menu	Setting	Note
Image Param	Video Recording	Video resolution	1920*1080/1440*1080/1280*720/848*480/640*480/320*240	
		Scene	Auto/Night Portrait/Night Scenery/Sports/Landscape/Portrait/Sunset	
		Digital effect	Off/Art/Sepia/Negative/Monochrome/Vivid	
		White Balance	Auto/Incandescent/Sunny/Cloudy/Fluorescent	
		ISO	Auto/100/200/400/800/1600	
		EV	0/+0.3/+0.7/+1.0/+1.3/+1.7/+2.0/-2.0/-1.7/-1.3/-1.0/-0.7/-0.3	
		Contrast	Standard/Hard/Soft	
		Sharpness	Standard/Hard/Soft	
		Duration	NO/15 minutes/30 minutes/45 minutes	
		Recycle record	NO/1 minutes/5 minutes/10 minutes/15 minutes/30 minutes/45 minutes	
	Usb in	NO/YES	NO : Connect USB, it will get into the USB menu settings YES : After connect USB, it will get into USB menu setting quickly and then it will automatically start recording after five seconds.	
	Video FLIP	NO/YES		
	MOD SENS	Off/On		
	Photo size	3M/4M/5M/8M/12M		
	Pictures	Scene	Auto/Night Portrait/Night Scenery/Sports/Landscape/Portrait/Sunset	
Digital effect		Off/Art/Sepia/Negative/Monochrome/Vivid		
White Balance		Auto/Incandescent/Sunny/Cloudy/Fluorescent		
ISO		Auto/100/200/400/800/1600		
EV		Standard/Hard/Soft		
Contrast		Standard/Hard/Soft		
Sharpness		1Pic/2Pic/3Pic		
Playback	Burst	NO/3 seconds/5 seconds/10 seconds		
	Self timer	NO/3seconds/5seconds/10seconds	Press the picture button, after set the time will take pictures automatically	
	Delete file	NO/Delete		
	Slideshow	NO/1Second/2Second/3Second/5Second/10Second/		
System Setup	Display all files	YES/NO		
	Volume	0/1/2/3/4/5/6/7/8/9/10		
	Flicker	50HZ/60HZ		
	Auto power off	Off/1 minute/3 minutes/5 minutes	Without action, after set the time will automatically power off	
	TV out	NTSC/PAL		
	Stamp	Off/On	Video recording / pictures whether add into the time and date	
	Date&Time	(0000:00:00 00:00)		
	Format storage card	NO/YES		
	Reset	NO/YES		
	Version	(V.0000 00 0000)		
	MIC	Off/On		
	Language	English	日本語	
简体中文		Русский		
繁體中文		한국어		

Specifications

Sensor	5 Mage pixels CMOS
Lens	7.0mm
Focusing Range	10cm-infinity
Display	2.5"LTPS TFTLCD
Video output	HDMI:CTS 1.2Compliant , Support 1080i/720p output mode , Composite:NTSC/PAL
Still image	Still image(jpeg) Resolution : JPEG 4000x3000 Maximum output picture element:12M
Recording format	MOV
Recording resolution	1920x1080(30fps) 1440x1080(30fps) 1280x720(30fps) 848x480(60fps) 848x480(30fps) 640x480(30fps) 320x240(120fps) 320x240(30fps)
Video Codec	H. 264
Zoom	4X Digital Zoom
Recording media	Internal: 32 External:SDHC/MMC Card(Upto 32G SDHC Card)
Audio	Mic and Speaker(Mono)Equipped
Shutter button	Electronic shutter
Shutter speed	1/2 – 1/1000 second
White Balance	Auto/Sunny/Cloudy/Tungsten/Fluorescent
LED Light	Auto/LED On/LED Off
Port	USB 2.0/HDMI/TV
Battery	3.7V 1000mAh Rechargeable Lithium-ion Battery
USB	High Speed USB 2.0
Size/Weight	106.7(L)x53.9(W)x33.3(H)mm Weight:128g
Working humidity/ Temperature	10% – 80% / 0°C ~ 40°C

Accessories Contained

Notice: Please kindly check the accessories according to the above diagram to avoid any unnecessary loss.

• Optional Accessories



F900HD



F900HD
Pouch



User manual



Lithium-ion
Rechargeable
battery



Charger



HDMI cable



USB Cable



Hanging Strap



TV Cable
(Optional)



SD Card
(Optional)



Vehicle power
charger
(Optional)



Bracket
(Optional)



Handle rope
(Optional)



USB cable (long)
(Optional)

Troubleshooting

- **Cannot take pictures, videos and voice recording?**

Change resolution, image quality, frame frequency; change for a memory card with enough space; check whether if the memory card is locked or not; delete part of files stored in the card.

- **Images cannot be transferred to HDTV screen?**

Please make sure that the HDMI cable is completely plugged into TV'S HDMI port. Please use the HDMI cable comes along with the F900HD.

- **Pictures and videos taken are not clear?**

Please check if lens is covered with any dirty. If so, clean the lens before using it. Or check the focus zone if is Correct.

- **The flash LED cannot light on?**

Under video or camera mode, if the battery is low, the flash LED cannot work.

Tips for operating F900HD video camera is similar to computer.

If F900HD video camera is not working, please operate as follow:

- 1.Take out battery, Re-insert the battery, Restart the video camera.
- 2.Press the reset button when F900HD is unusual.
- 3.Please do not press the reset button while F900HD is in the normal condition, data might get lost.

Installation instruction

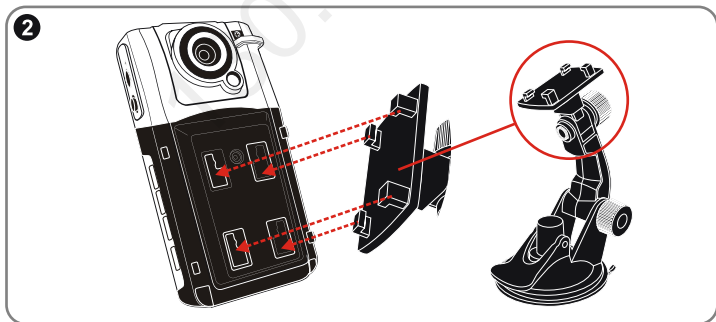
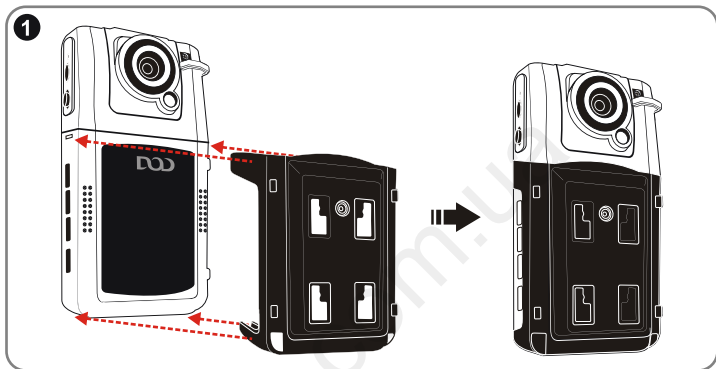

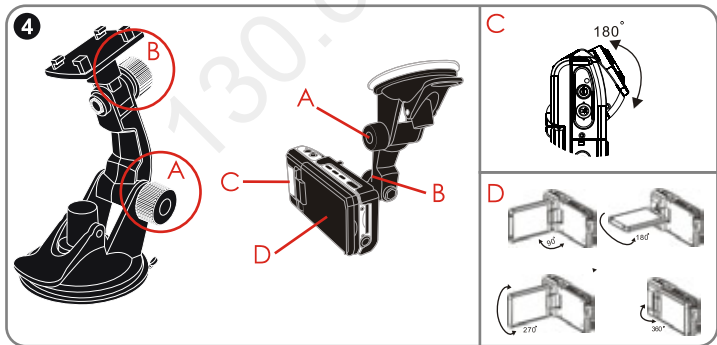
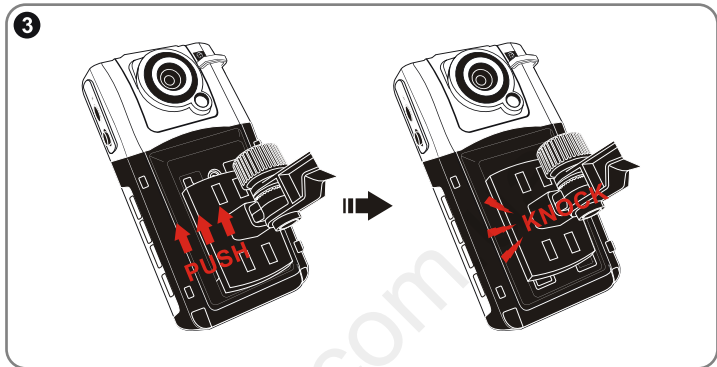

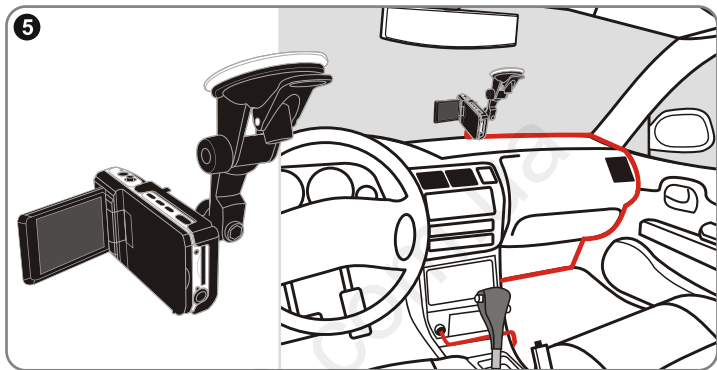

前言

感謝您購買 **F900HD** 高解析數位攝影機。本產品外觀迷你精緻，獨特的營幕翻轉功能配合多功能使用，實現大角度的拍攝。

本用戶手冊將詳細說明如何使用，同時提供給你的詳細信息，包括使用、操作、安裝注意事項及技術規格等，使用前請仔細閱讀本手冊並完全理解，請妥善保存本手冊，我們希望本產品能滿足您的需求並長期服務於您！

產品保證

本產品通過 **ISO9001:2000** 國際品質管理體系認證及經 **FCC CE** 和 **SGS** 等權威機構認證符合推薦指標，顧客使用具有安全保證。

產品概述

此款產品是針對市場需求推出的一款超小型高畫質數位攝影機。該產品具有領先群雄的高畫質數位影音錄影、拍照、高速USB數據傳輸、USB充電等功能，並擁有多項發明及技術專利。

使用範圍廣泛，可方便隨時隨地錄影.....



產品特性

- 超小體積螢幕翻轉功能設計配合多功能使用，方便各種場合輕鬆高解析視訊拍攝、拍照，超清晰畫面隨意捕捉。
- **2.5**吋 LTPS TFT LCD
- **1/2**吋高畫質感光元件
- **4**片定焦鏡，焦距範圍**10cm**到無限遠
- **4X**數位變焦
- 夜間LED攝影補光燈
- 視訊規格：MPEG-4 AVC/H.264
- 內建麥克風／喇叭
- 大容量充電鋰電池
- 支援大容量SD(SDHC)記憶卡
- 高解析多媒體接孔：TV/HDMI直播直錄，可直接與高畫質電視連接使用
- 循環錄影功能
- 錄影時間可自行設定
- 鏡頭180度反向設定功能
- 可邊供電邊錄影
- 可設定汽車發動自動開機錄影
- 螢幕休眠模式

• 視訊錄製時間及拍攝數量 (供參考)

	Memory card(Gbyte)			
	1G	2G	4G	8G
1920X1080 (FPS30)	10min	20min	40min	80min
1440X1080 (FPS30)	16min	32min	64min	128min
1280X720 (FPS30)	20min	45min	90min	180min
848X480 (FPS60)	21min	42min	84min	168min
848X480 (FPS30)	32min	64min	128min	256min
640X480 (FPS30)	66min	133min	266min	533min
320X240 (FPS120)	47min	94min	188min	376min
320X240 (FPS30)	188min	376min	752min	1504min
3 M	957photos	1914photos	3828photos	7656photos
4 M	672photos	1344photos	2688photos	5376photos
5 M	586photos	1148photos	2386photos	3996photos
8 M	386photos	753photos	1565photos	3193photos
12 M	300photos	600photos	1200photos	2400photos

根據拍攝主機、記憶卡品牌以及其他設定的不同，文件尺寸、可拍攝的數量將會有所不同。

產品結構

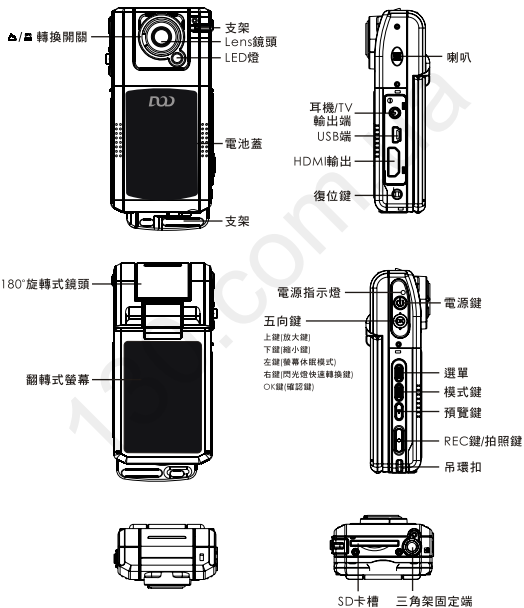

Autogood products "130"

使用安裝

• 安裝和取出電池

1. 向下滑動電池蓋可將它開啟。
2. 按照電池上標示的正負符號和箭頭方向符號指示把電池裝入攝影機電池槽內，直至安裝到位；
3. 電池電量指示，請參考圖示



4. 取出電池，推開電池蓋即可將電池取出。

• 電池充電

1. 充電器充電：將USB連接線一端與充電器的USB接頭連接，另一端與攝影機的USB端連接，在開機狀態下即可進行充電。
2. USB充電：用USB連接線連接電腦，此時出現畫面如下圖，選擇「CHARGE」，開始進行充電。

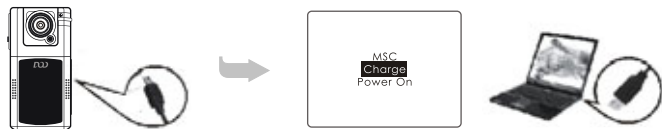

• 安裝和取出記憶卡

1. 按照指示方向將記憶卡插入記憶卡槽直至記憶卡被固定在卡槽中為止。
2. 取出記憶卡時，輕輕壓下記憶卡，待卡片彈出後，即可以取出。

注意：

1. 使用SD記憶卡前請確定記憶卡上的防寫開關是否打開。
2. 請注意記憶卡插入的方向，若倒轉插入，可能會損壞機器與記憶卡。
3. 當您將記憶卡插入機器後，機器即會將此記憶卡設定為預設儲存的記憶體。此時之前存在內建記憶體中的資料暫時無法讀取。
4. 如果記憶卡與機器不相容時，請重新再插一次或再換一張記憶卡重試。

使用指南

• 設定選單模式

1. 在拍照 / 拍攝 / 回放任意模式狀態下按選單 "MENU" 鍵可進入其相對應的選單設定，詳細請參考設定目錄表。
2. 在任何模式的選單設定下按右鍵可選擇所需的工作狀態，按 OK 鍵確定。

• 攝影機開啟/關閉及自動關閉設定

1. 按住電源按鍵持續一秒左右可開/關機
 2. 為節省電池電量，可在選單內設定自動關機時間。當攝影機在設定時間內沒有操作便會自動關機。
- 打開電源，在任何模式下按選單 "MENU" 鍵選擇 "系統設置"，按下鍵選擇 "自動關閉"，再按右鍵可設定更改電源自動關閉的時間。

• 設定日期與時間

1. 打開電源，在任何模式下按選單 "MENU" 鍵選擇 "系統設置"，
，按下鍵選擇 "時鐘"，再按右鍵選擇年、月、日、時、分按上下鍵調整，再按下OK鍵，時間設定完成。

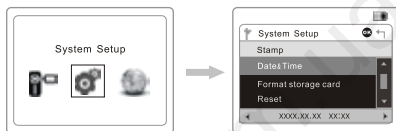







2. 在攝影或拍照模式狀態下，按下選單 "MENU" 鍵進入設定模式，按上鍵，然後按右鍵選擇設定選單 "⌚"，按下鍵選擇 "時間戳" 設定 "開啟"，所拍攝資料將會有拍攝的日期時間顯示。



• 攝影模式

1. 打開電源，攝影機完成開機程序，螢幕顯示攝影模式，隨即左上角出現攝影模式" "符號，此時已進入拍攝狀態。



2. 按下"REC"按鈕開始錄影，再按下"REC"按鈕停止錄影。
錄影進行時，螢幕將顯示計時器，與左上角的" "圖示將轉為閃動的紅色" "圖示，錄影停止同時，計時器消失及左上角閃動的紅色" "圖示隨即轉為錄影" "圖示。
3. 閃光燈的選擇
在攝影狀態下按閃光燈快速轉換鍵(右鍵)，可循環選擇關閉閃光燈" "，自動閃光" "(依外界光線強弱，拍照能夠自動補光)或強制閃光" "。

注意：當電池圖示出現1格低電量時，閃光燈功能將自動關閉。

4. 遠近轉換制的選擇
" "時，拍攝距離為1.5m - 無限遠。
" "時，拍攝距離為10cm

Autogood products "130"

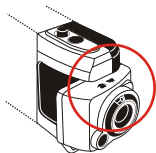

• 拍照模式

1. 打開電源，攝影機完成開機程序，在攝影模式，按下模式 "MODE" 鍵，選擇拍照模式，隨即左上角將出現拍照模式 "📷" 符號，此時已進入拍照模式。



2. 將相機對準拍照主體，並可按上下鍵進行數位變焦，此時要抓穩攝影機盡量不要抖動。
3. 按下 "REC" 按鈕時，相機發出 "咔嚓" 一聲，拍照完成。
4. 自拍功能
在拍攝模式下按選單 "MENU" 鍵選擇 "圖像參數"，然後按下鍵選 "自拍" 選項，再按右鍵可進行自拍功能選擇。

提示：

1. 在攝影和拍照任何一模式狀態下按 "MODE" 鍵可循環切換攝影和拍照模式。
2. 在攝影、拍照模式下，按左鍵可快速近入螢幕休眠模式。

• 回放模式

1. 當攝影機完成開機程序並進入攝影模式，此時按回放鍵，可進入單張回放模式，按左鍵或右鍵可對圖片影音資料進行選擇瀏覽。
2. 按下鍵可進入索引回放模式，選擇圖片後可按上下左右鍵瀏覽圖片影音資料。此時按"OK"鍵隨即進入單張回放模式，可對圖片影音資料進行操作。
 - 顯示畫面中間出現"▶"符號時為影音資料，如要播放視訊文件，可按"OK"鍵進行播放或暫停，在播放時，可用左、右鍵進行後退或快進選擇，即出播放先按"OK"鍵暫停播放視訊，再按左鍵或右鍵到單張模式。
3. 截圖功能
在回放視訊資料過程中，當看見想留下的當前畫面，按下"OK"鍵暫停，再按"REC"鍵拍照"喀嚓"。該畫面將被作為JPG文件記錄下來，按"OK"鍵繼續播放。
4. 刪除
在回放狀態(播放拍攝/錄影)時，只要按選單"MENU"鍵，螢幕即出現刪除資料的選擇並按右鍵可選擇刪除資料方式按"OK"鍵確定。
5. 幻燈片回放
在回放狀態(播放拍攝/錄影)時，可選擇幻燈片回放方式，按選單"MENU"鍵，再按下鍵選擇"幻燈片回放"設定，按"OK"鍵確定。

• 邊供電邊錄影模式

以USB備用電源與機器連接後，此時出現畫面如下圖，選擇「POWER On」，此時可正常使用，採用外部電源供電(不會充電)

※注意！任何情況下斷開USB，主機會自動關機。

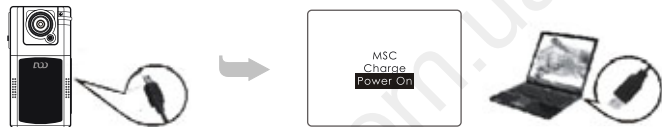

• 螢幕休眠模式

在攝影或拍照模式狀態下，按左鍵，即可進入螢幕休眠狀態，按再一次左鍵則回復到原模式。

• 螢幕翻轉



資料備份

· USB 備份模式

以USB線將機器與電腦連接後，此時出現畫面如下圖，選擇「MSC」，打開電腦桌面"我的電腦"，出現兩個可移動磁碟(一個內部記憶體，一個是SD記憶卡)：在"可移動磁碟/DCIM/100 MEDIA"路徑下找到被儲存的影像。若未插入SD卡時，內部記憶體作為對應的可移動磁碟

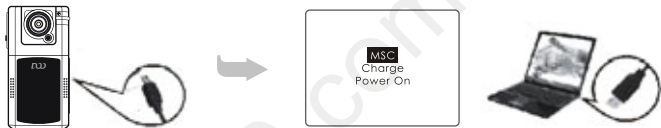

· 連接電視機視訊播放

1. 用HDMI連接線可連接攝影機至高畫質電視機進入錄影/拍照/瀏覽播放圖片影音資料。
2. 用TV連接線可連接攝影機至電視機，進入錄影/拍照/瀏覽播放圖片影音資料。

小提示：無需安裝驅動程序，在攝影機開機狀態下才能使用移動式磁碟。

按鍵功能

錄影 / 拍照模式

電源鍵	關機
快門鍵	錄影 / 暫停錄影
方向鍵(上鍵)	1/2/3/4倍數位變焦(1080P錄影時無法使用)
方向鍵(下鍵)	4/3/2/1倍數位變焦(1080P錄影時無法使用)
方向鍵(左鍵)	螢幕休眠模式
方向鍵(右鍵)	閃光燈切換：自動/強制/關閉
選單鍵	選單選擇
模式鍵	模式選擇
回放鍵	瀏覽圖片及影音資料

回放模式

預覽(單張)

電源鍵	關機
方向鍵(下鍵)	索引圖
方向鍵(左鍵)	上一張
方向鍵(右鍵)	下一張
OK鍵	播放視訊
選單鍵	選單選擇
模式鍵	模式選擇
回放鍵	瀏覽圖片及影音資料

預覽(索引圖)

電源鍵	關機
方向鍵(上鍵)	上一行 / 上一頁
方向鍵(下鍵)	下一行 / 下一頁
方向鍵(左鍵)	上一張 / 上一頁
方向鍵(右鍵)	下一張 / 下一頁
OK鍵	進入文件播放模式
選單鍵	選單選擇
模式鍵	模式選擇
回放鍵	瀏覽圖片及影音資料

按鍵功能及功能圖示

回放時(視訊 / 音訊)

電源鍵	關機
方向鍵(上鍵)	音量+(0-8)
方向鍵(下鍵)	音量-(8-0)
方向鍵(左鍵)	後退(2.4.8倍速度)
方向鍵(右鍵)	快進(2.4.8倍速度)
OK鍵	播放/暫停(不管在後退或快轉時)
選單鍵	進入回放選單
模式鍵	退出播放，進入攝影模式
回放鍵	瀏覽圖片影音資料

回放時(圖片)

電源鍵	關機
方向鍵(下鍵)	縮小(索引圖)
方向鍵(左鍵)	上一張
方向鍵(右鍵)	下一張
OK鍵	進入單張圖片播放
選單鍵	進入回放選單
模式鍵	退出播放，進入攝影模式
回放鍵	瀏覽圖片影音資料

- 當您使用本機時，會出現不少功能圖示，為了您能更好更快地掌握本機的使用方法，特將圖示明細如下，供您檢索了解。

 錄影	 自動閃光	 晴天
 拍攝	 強制閃光	 陰天
 播放	 不閃光	 鎢絲燈
 系統設置	 螢光燈	 記憶卡
 高畫質	 3M圖像大小	 4M圖像大小
 5M圖像大小	 8M圖像大小	 12M圖像大小
 電池電量	 WVGA	 QVGA
 VGA	 連拍	 自拍
 聲音開	 聲音關	

模式設定目錄和系統設定目錄

模式	選單	選擇設定	註釋	
錄影 模式	錄影時間	1:20*/1:00/1:44/0*/1:00/1:28/0*/2:0/ 8:48/0*/14:40*/4:00/3:20*/2:40		
	場景 (AE)	自動/夜間人像/夜景/運動/風景/人像/日落		
	特效 (DE)	關閉/藝術/懷舊/負片/黑白/靜態		
	白平衡 (WB)	自動/超級燈/晴天/多雲/螢光燈		
	感光度 (ISO)	自動/100/200/400/800/1600		
	曝光 (EV)	0/+0.3/+0.7/+1.0/+1.3/+1.7/+2.0/ -2.0/-1.7/-1.3/-1.0/-0.7/-0.3		
	對比度	標準/高/柔和		
	銳利度	標準/高/柔和		
	攝影時間	NO/15分鐘/30分鐘/45分鐘		
	循環錄影	NO/1分鐘/5分鐘/10分鐘/15分鐘/ 30分鐘/45分鐘		
	連接 USB	否/是	否：連接 USB 後會進入 USB 選單設定 是：連接 USB 後先跳出 USB 選單過 5 秒自動開機錄影	
	影像翻轉	否/是		
	移動偵測	否/是	移動偵測的敏感程度會因光線強度的不同而有所不同	
	拍攝	圖像尺寸	3M/4M/5M/8M/12M	
		場景(AE)	自動/夜間人像/夜景/運動/風景/人像/日落	
特效(DE)		關閉/藝術/懷舊/負片/黑白/靜態		
白平衡(WB)		自動/超級燈/晴天/多雲/螢光燈		
感光度(ISO)		自動/100/200/400/800/1600		
曝光(EV)		0/+0.3/+0.7/+1.0/+1.3/+1.7/+2.0/ -2.0/-1.7/-1.3/-1.0/-0.7/-0.3		
對比度		標準/高/柔和		
銳度		標準/高/柔和		
連拍		1張/2張/3張		
自拍		NO/3秒/5秒/10秒	按下拍攝按鈕，經過設定的時間後自動拍照	
回放		刪除文件	取消/刪除	
	幻燈片播放	NO/1秒/2秒/3秒/5秒/10秒/		
	顯示所有文件	是/否		
系統 設置	音量	0/1/2/3/4/5/6/7/8/9/10		
	視訊系統	50HZ/60HZ		
	自動關閉	關閉/1分鐘/3分鐘/5分鐘	若無動作，經過設定的時間後自動關機	
	TV 輸出	NTSC/PAL		
	時間錄影	關閉/開啟	在錄像/拍照中是否加入時間日期	
	時鐘	年月日時分(0000:00:00 00:00)		
	格式化	否/是		
	重設系統	否/是		
語言 選擇	系統版本	版本編號(V.0000 00 0000)		
	聲音	關閉/開啟		
	English	日本語		
	簡體中文	Русский		
	繁體中文	한국어		

產品規格

感光元件	5 Mage pixels CMOS
鏡頭	7.0mm
焦距範圍	10cm-無限遠
液晶螢幕	2.5" LTPS TFT LCD
視訊輸出	高畫質多媒體接頭：HDMI CTS1.2支援1080i/720p WVGA輸出模式 電視合成訊號：NTSC/PAL
照片	照片格式：JPEG 4000*3000 最高輸出像素：12M
錄影格式	MOV 檔
視訊	1920*1080 (30張/秒) 1440*1080 (30張/秒) 1280*720 (30張/秒) 848*480 (60張/秒) 848*480 (30張/秒) 640*480 (30張/秒) 320*240 (120張/秒) 320*240 (30張/秒)
視訊壓縮格式	H.264
變焦	4 倍數位變焦
錄影媒介	內建：32M 外接：SDHC SD卡(最高支援32GB, SDHC卡)
音訊	內建麥克風 / 喇叭(單聲道)
快門	電子快門
快門速度	1/2 - 1/1000秒
白平衡	自動 / 晴天 / 陰天 / 鎢絲燈 / 螢光燈
LED燈	自動 / 開啟 / 關閉
接頭	USB 2.0 / HDMI / TV
電池	內建高容量鋰電池, 3.7V 1000mAh
USB	USB 2.0 高速傳輸
尺寸/重量	長106.7 X 寬53.9 X 厚33.3mm / 約128克
工作溫度/溼度	-10° C ~ 60° C / 10% ~ 80%

Autogood products "130"

包裝附件

溫馨提示：請您在購買本產品的時候，按圖示清點附件，以免造成您的損失！



F900HD



攝影機袋



使用說明書



可充電電池



充電器



HDMI 連接線



USB 連接線



吊繩



AV 連接線
(選購)



SD Card
(選購)



車用電源
(選購)



支架(選購)



握把繩(選購)



長 USB 連接線
(選購)

簡易疑難排除

· 不能拍照、攝影、錄音？

請更改拍照或錄影解析度或更換有足夠空間的記憶卡。並檢查記憶卡是否鎖住。

· 沒有影像顯示在高畫質電視螢幕上？

請確認HDMI視訊線接頭是否完全插入，使用隨機提供的HDMI視訊線。

· 拍出的照片及拍攝錄影不清晰？

請將鏡頭擦拭乾淨後再使用，或者檢查對焦距離是否準確。

· 閃光燈無法啟用？

當電池電量不足的情況下，閃光燈不能啟用。

操作時的小提示

本攝影機和電腦很相似，如果發生攝影機無動作的情況，請按照下列步驟操作：

1. 取出電池，重新裝入電池，重新開機
2. 在攝影機出現異常情況，請按RESET鍵再按電源鍵重新開機。
3. 請謹慎使用RESET鍵，否則可能會引起資料遺失。

支架安裝說明

安裝步驟：

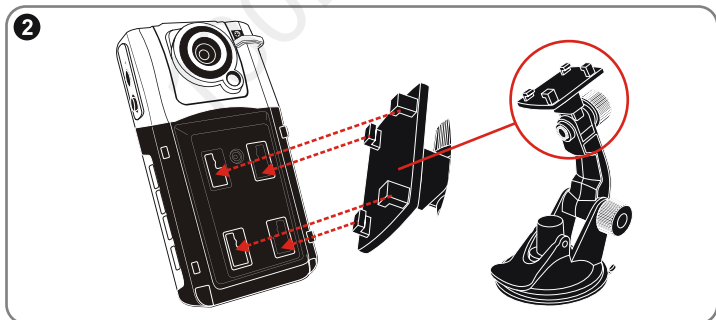
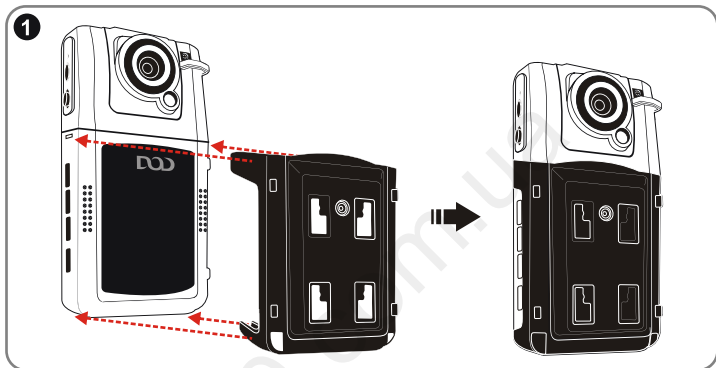

Autogood products "130"

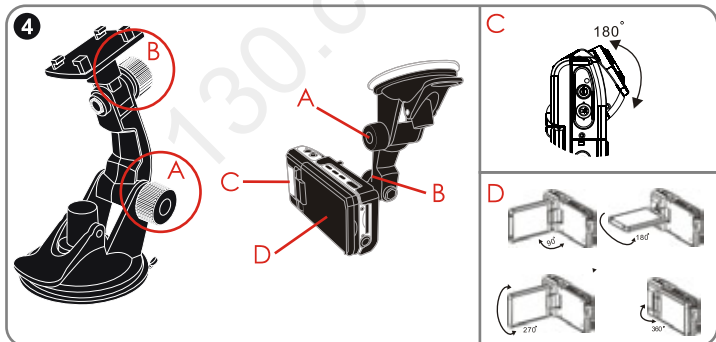
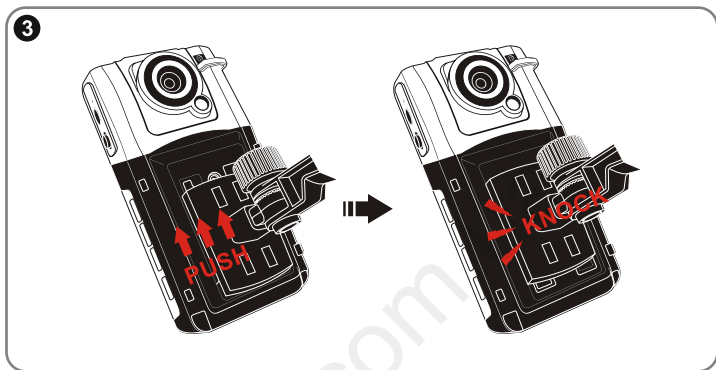

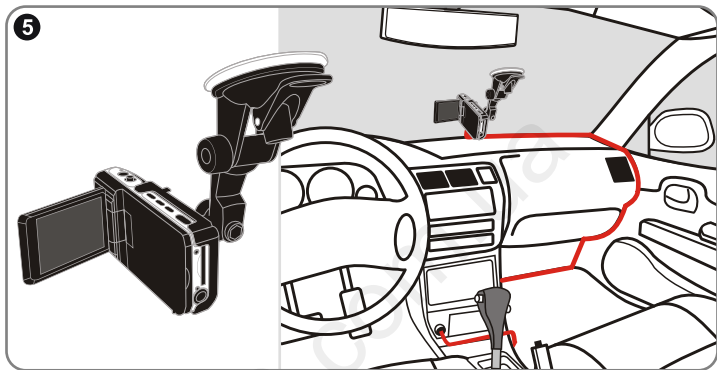

130.com.ua

Autogood products "130"

Δ DOD
Dream Of Digit-tech